

YAMAHA SYNTHESIZER CS-10

● OWNERS MANUAL

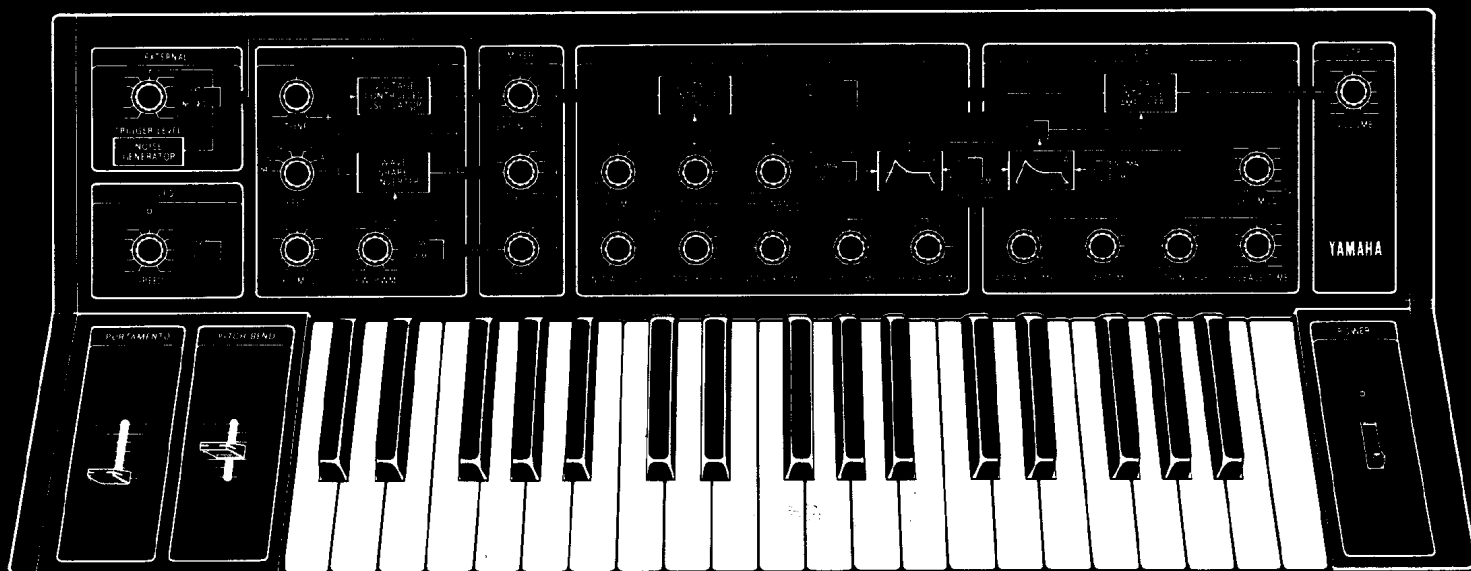

SYNTHESIZER CS-10

We thank you very much for your purchase of our YAMAHA Synthesizer CS-10. CS-10 is a synthesizer developed based on YAMAHA's superior technology and rich experience cultivated over the years with YAMAHA Electone Organs and by giving full play to latest IC technology.

EXTERNAL

- **TRIGGER LEVEL** (page 12)
Adjusts trigger level produced by EXTERNAL terminal input.
- **EXT/NOISE** (pages 7, 12)
A switch for effecting switchover between EXTERNAL terminal input and noise.

LFO

- **SPEED** (page 8)
Adjusts the frequencies of LFO (low frequency oscillator).
- \sim / \sphericalangle Sine/saw-tooth (Page 8)
Effects switchover between the wave forms of the LFO.

VCO

- **TUNE** (Page 8)
Used for adjusting intervals.
- Tuning is to be carried out after about 30 minutes have past, when the interval have stabilized, following switch-on of power.
- **FEET** (Page 8)
Shifts over sound range of keyboard.
- **LFO MOD**
Modulates VCO with LFO (low frequency oscillator).
- **PW/PWM control** (Page 8)
Depending on how the PW/PWM switch is positioned, functions as a PM, or PWM control.
PW: By changing the pulse width of the square wave, becomes a sound source other than that of symmetrical square waves.
PWM: Changes the pulse width periodically.
- **PM/PWM switchover switch**
Effects switchover between PW and PWM.

MIXER

- **EXT/NOISE**
 - \sphericalangle : Saw-tooth wave.
 - \square : Square wave
- Selects the sound source, by adjusting the respective levels and mixing them. (Page 7)

PORTAMENTO

Sets the shift time for "PORTAMENTO" effect.

(Page 11)

PITCH BEND

Permits pitch to be changed by manual operation.

(Page 11)

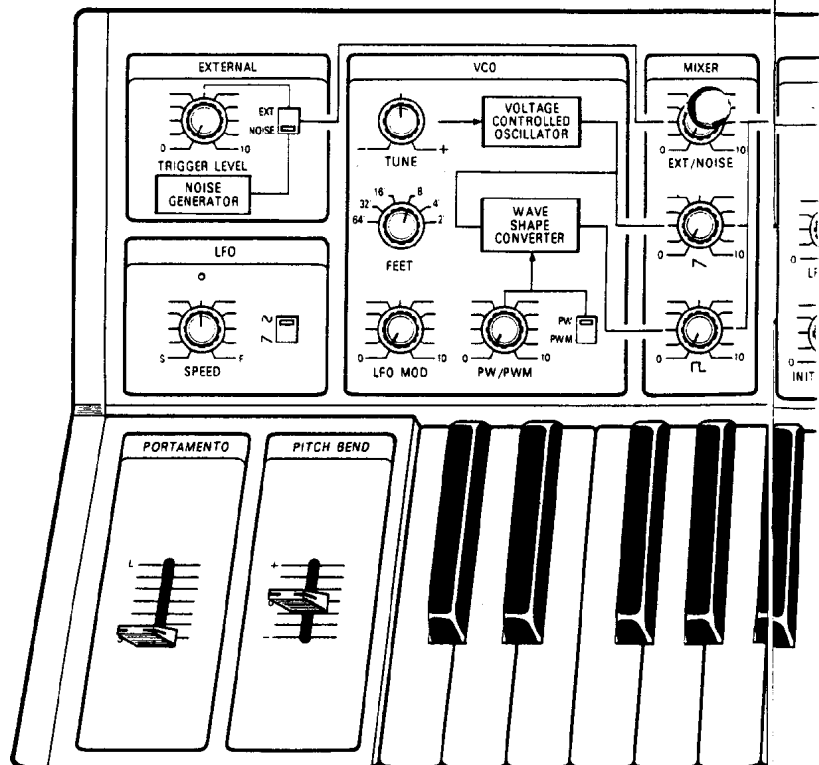

VCF

- HPF/BPF/LPF** (Page 9)
Selects the filter type.
- LFO MOD** (Page 10)
Modulates VCF with LFO.
- CUT OFF FRQ.** (Page 9)
Makes the basic tone.
- RESONANCE** (Page 9)
Further emphasizes the tone produced by the CUT OFF FRQ.
- INITIAL LEVEL**
- ATTACK LEVEL**
- ATTACK TIME (A)**
- DECAY TIME (D)** (Pages 9 and 10)
- RELEASE TIME (R)**
Produces the VCF envelope.
- NORMAL/TIME x 5** (Page 10)
Expands the time for "A", "D" and "R" to 5 times the normal time.

- **TRIGGER** (Page 10)
KBD: For ordinary keyboard playing this KBD-side is to be used.
EXT. Used with external signals.
- **Trigger Indicator**
Trigger signals used for controlling EG-VCF and EG-VGA cause this indicator to light up.

VCA

- **HOLD/EG** (Page 10)
When set to HOLD, will cause signals to pass the EG/VCA.
- **LFO MOD** (Page 11)
Modulates VCF with LFO.
- **ATTACK TIME** • **DECAY TIME** • **SUSTAIN LEVEL**
- **RELEASE TIME** (Pages 10 & 11)
Produces envelope for VCA.
- **NORMAL/TIME x 5** (Page 11)
Increases the time of "A", "D" and "R" to 5 times the normal one.

OUTPUT

- **VOLUME** (Page 7)
This is a control for over-all volume adjustment.

POWER

- POWER INDICATOR**
- POWER SWITCH**

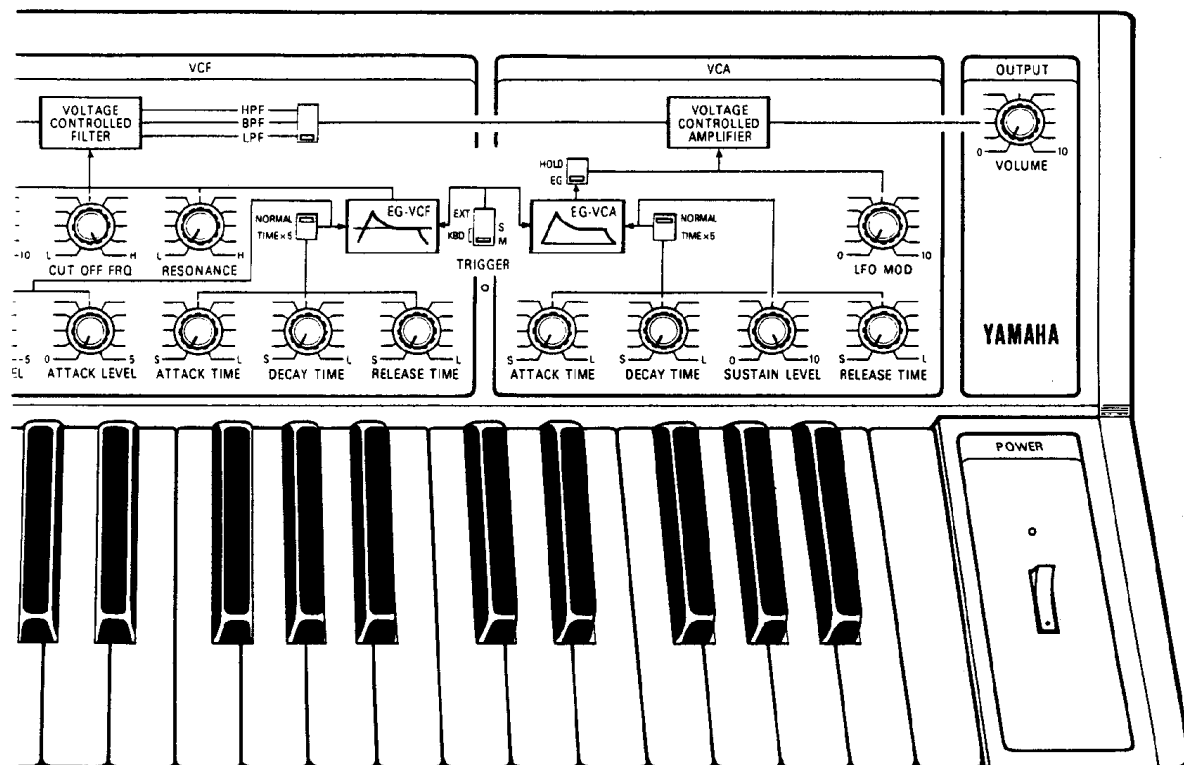

WHAT IS A SYNTHESIZER

Unlike other musical instruments, the synthesizer has no fixed sound of its own. Thus, before playing it, it is necessary to make the sounds. But with the synthesizer you will be able to make, with your own hands and by synthesizing sounds, a new type of sounds that can never be made by any other musical instrument.

THE THREE ELEMENTS OF SOUND

How does a synthesizer make sounds? Before explaining the arrangement of the synthesizer, let us consider what kind of properties sound has.

Sound produced by such musical instruments as the piano and guitar has an interval and sound level, according to the keyboard or chord used. It is possible to change the intervals by changing the length of the chord for the portion that is vibrating. In this case, the chord's number of vibrations per second also changes. The chord will vibrate more slowly, the lower the interval becomes. In this way, it is possible to express the difference in intervals by the number of vibrations (frequencies).

Interval

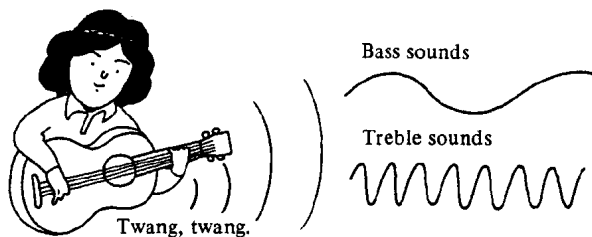

However, between the sounds of a piano and a guitar, there is a difference in tone even when both sounds are of the same interval: no one will mistake the tone of the piano from that of a guitar. This is because there is a difference in the way the chords vibrate (the vibration wave form), due to the difference in the arrangement by which the sounds are made to generate, and because of the difference in the shape and size of the musical instruments.

Tone difference

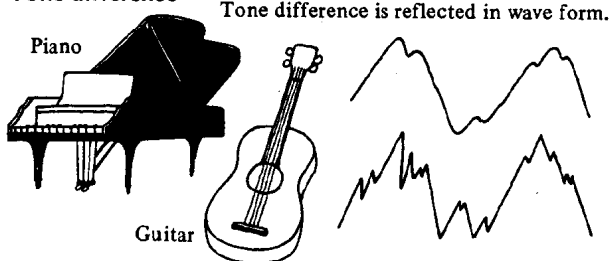

Furthermore, even when both the interval and tone quality are the same there is a difference in sound, as when the same key of the piano is hit in a forcible manner and a gentle manner, it would be easy to

discern the two sounds from each other because of the magnitude (volume) of the sound. This is because a difference will be produced in the size and amplitude of the chord vibrations, due to the intensity with which the chord has been struck.

In this way, sounds produced by musical instruments have such elements as intervals, tone and volume, whose differences render the sound with certain characteristics. These elements are referred to as "the three elements of sound", which may be also considered as being the difference in the frequencies, wave forms and amplitude.

CHANGES WITH TIME IN SOUNDS

However, the elements which render sounds with certain characteristics are not confined to these three. Taking the piano for example, the volume will reach maximum the instant the key is hit, then will decrease gradually. When the finger is released from the keyboard, the sound will fade out. In the case of the organ, the action of depressing the keyboard will cause the volume to rise to a certain level, which will be retained for the duration the key is depressed. The sound will die away when the finger is released from the key.

Envelope

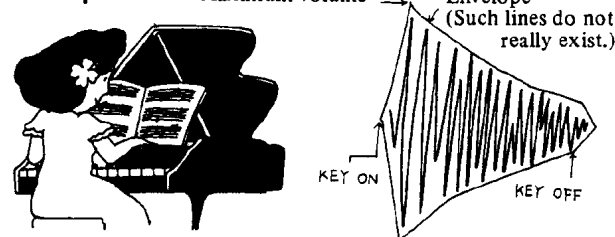

Further, in such musical instruments as the trumpet, the harmonic spectrum changes together with the change in volume. The tone changes too, along with the passage of time.

Thus, such sounds as those of musical instruments undergo delicate changes from the time the sound is generated to the time it fades away. The mode in which sound changes with time is known as "envelope".

HARMONICS

What must we do in order to produce electrically sounds that have the three elements of sound, that is, the intervals, tone and volume, and which vary with time (has an envelope). Before going into the matter, let us view sound again from a different angle.

As regards the vibration wave forms by which the tone is determined, it is known that any given wave form can be measured by using the sine wave as a measure. In other words, all wave forms can be analyzed into a large number of sine waves. For example, let us overlap, over a single sine wave, wave forms having an integral multiple number of vibrations,

such as 2-fold, 3-fold, and so on. You will see that the wave form will gradually come to resemble a saw-tooth-like wave form. In addition to this, you will see that this saw-tooth wave form has a cycle similar to that of the sine wave that has been used as the basis. This sine wave that has the basic cycle is referred to as the fundamental sound and the sine waves of harmonic overtones as the harmonics. In the case of musical instruments, the way in which harmonics are contained in sounds will depend on the arrangement by which sounds are caused to generate. When we discuss the difference in tones (wave forms), it is the same as discussing what kind of harmonics the sounds contain.

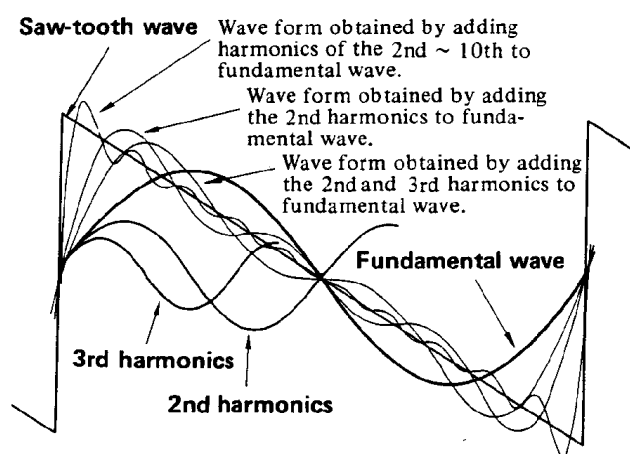

STRUCTURE OF SYNTHESIZER

In the synthesizer, sounds are synthesized by effecting control on the four properties of sound (the three elements of sound plus the envelope), dividing control into 4 blocks.

Control of intervals is effected by the VCO, that of harmonic spectrum by the VCF, that of volume by the VCA and that of envelope by the EG (envelope generator). The following describes the controls by each block.

VCO

The VCO block produces a sound source of frequencies corresponding to the intervals of the keyboard. The sound source wave forms produced by the VCO consists of such waves as saw-tooth waves and square waves that include many harmonics in a regular manner. These waves are oscillated, using an electrical circuit.

VCF

The VCF block makes the tone, by changing the harmonic spectrum of the sound sources by cutting, or emphasizing, a part of the harmonics by passing the sound sources through filters. The boundary between the portion that passes through the filter and the portion that is cut off is known as the cut-off frequency. The

VCF renders the harmonic spectrum with characteristics, by varying the cut-off frequency.

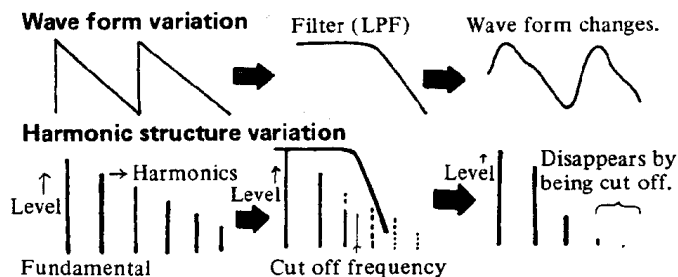

In addition to adjusting the cut-off frequencies by means of a knob, the tone is caused to undergo a change with time (from the time the sounds generate to the time they die away) to give it an "envelope". This is accomplished by effecting control on the filter's cut-off frequencies by means of the envelope generator.

VCA

The VCA block functions to give volume an envelope. The mode of volume starting from the generation (positive edge) of the sound, up to the point the sound fades away leaving reverberations is produced by controlling the envelope generator's A.D. and S.R., which in turn, controls the amplification degree of the VCA amplifier.

VCF signals Envelope generator VCA output

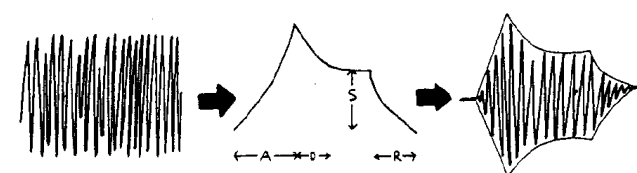

The intervals oscillated by the VCO reach the VCF where they undergo a change with regard to their harmonic spectrum by being passed through a filter. These signals rendered with certain tone characteristics are given a volume envelope at the VCA and are fed out. In this way, all elements of the properties of sound are controlled electrically, by utilizing the three elements of sound and the envelope. The synthesizer has, in addition to the blocks described, other blocks such as the LFO that renders delicate changes to the sounds. But in this case, too, the job is performed by controlling the three elements of sound and the envelope.

We hope that you have fully understood the points described in this section in order to enjoy the immense pleasure of opening a path that will lead you into a new world of music using a new musical instrument, the synthesizer.

CONNECTION

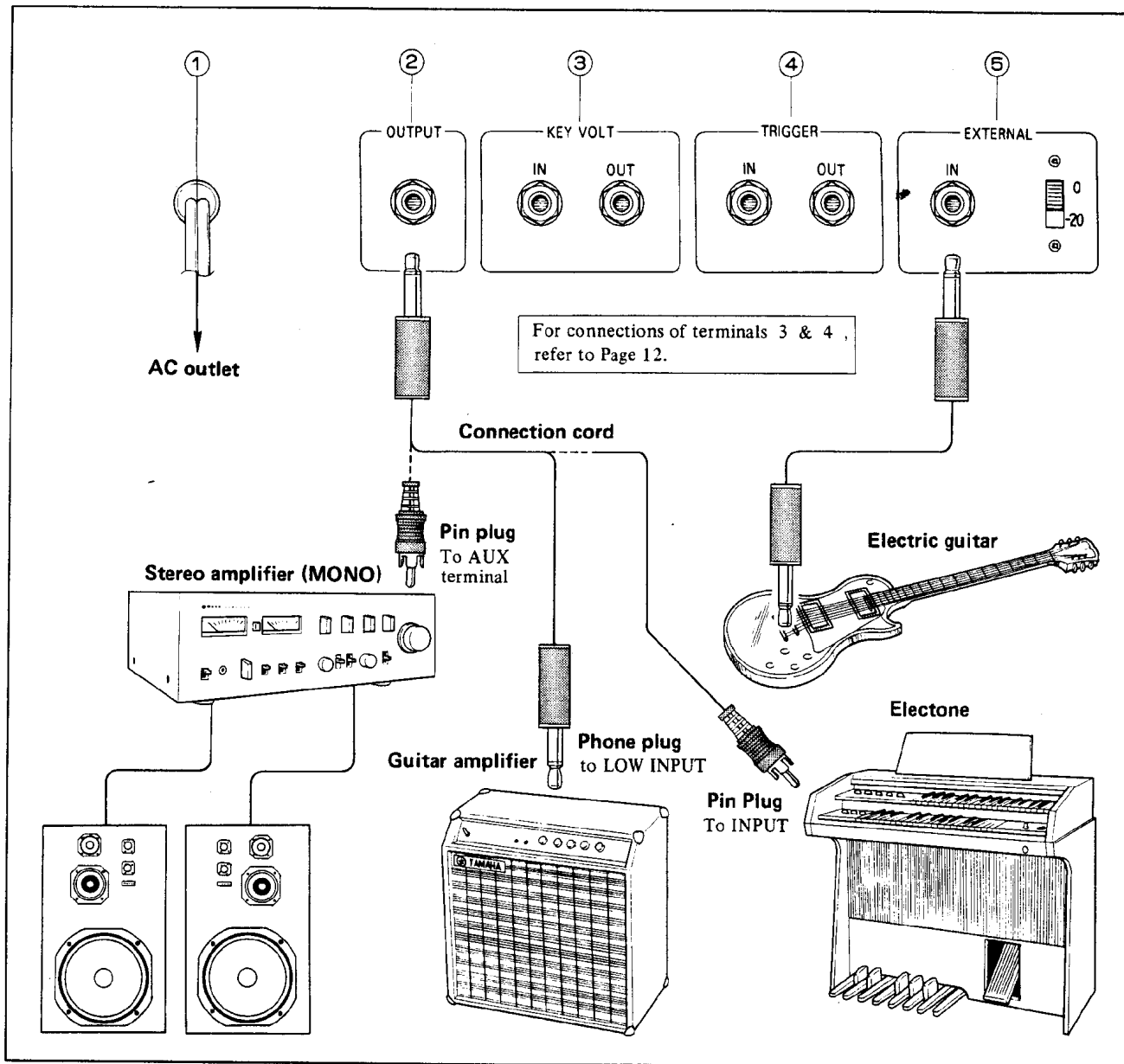

① POWER CORD

Insert plug into AC outlet.

② OUTPUT (output terminal)

The CS-10 can be connected to any type of amplifier. Use a cord whose one end has a plug that matches the configuration of the input terminal of the amplifier to be used. The amplifier's input terminal should be connected to such terminals as:

Guitar amplifier LOW INPUT
 Stereo amplifier AUX terminal
 Electone EXT IN, AUX IN, EXP IN.

③ KEY VOLT and 4 TRIGGER

By connecting a synthesizer having the same KEY VOLT and TRIGGER terminals as the YAMAHA synthesizers, it is possible to build a 2-system synthesizer. For further details, see page 12.

④ EXTERNAL

By connecting such instruments as an electric guitar as a sound source, the control block will function to provide a synthesizer effect. For further details, see page 12.

FUNCTIONS KEYBOARD/MIXER

The following describes the function of each section in compliance with the signal flow. Actually turn and with the description of each item and confirm the change to acquire proper knowledge of the functions.

① POWER (Power switch)

Depress POWER switch on this side. This will cause the pilot lamp to light and the synthesizer to be put into the operation mode.

② VOLUME

This is used to adjust the overall volume. Set the control on the amplifier's side to an optimum position.

③ KEYBOARD

The CS-10 is a 3-octave monotone synthesizer that has 37 keys.

- When 2, or more keys are pressed simultaneously, priority will be given to the key of the higher interval.

To produce actual sounds by depressing the keys, the controls of the VCA and VCF blocks should be positioned as shown in the drawing.

VCF HPF/BPF/LPF switch → LPF

CUT OFF FREQ. → H (turned fully clockwise)

VCA HOLD/EG switch → EG

- When set to HOLD, the sound of the key depressed immediately prior to this will be produced, even when releasing the finger from the keyboard.

TRIGGER → KBD (M)

SUSTAIN → 10 (turned fully clockwise)

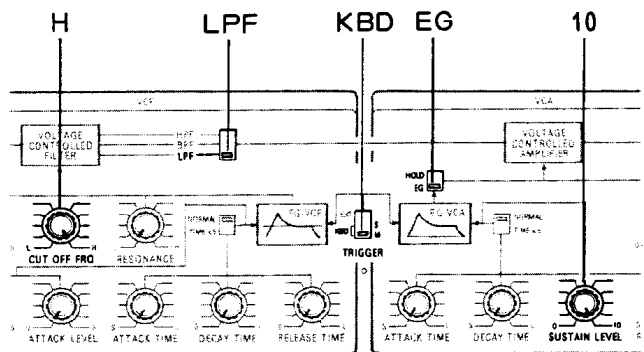
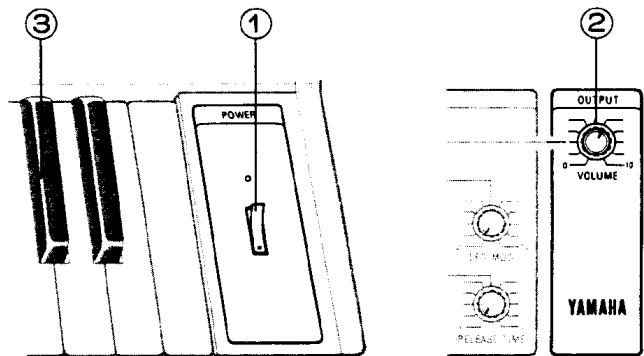

MIXER

Select the wave form that will be used as the sound source and adjust the input level for the VCF block using the MIXER controls.

④ EXT/NOISE: Adjusts signal level of NOISE, or EXTERNAL terminal.

⑤ : Adjusts level of saw-tooth wave.

⑥ : Adjusts level of square wave.

⑦ NOISE

This is white noise which contains in an even manner frequency components from the bass to the treble range, and is best suited as sound effects for wind, waves, train, etc. This noise can be obtained by positioning the EXT/NOISE switch to NOISE.

- EXTERNAL: Refer to page 12.

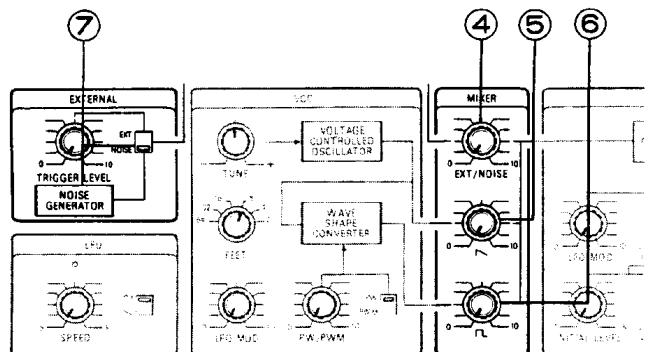

FUNCTIONS VCO/LFO

① TUNE (Interval)

This control functions to adjust intervals. When turned clockwise, the pitch will increase, and when turned counterclockwise, the pitch will decrease. This control is employed when tuning the synthesizer to other musical instruments.

- Tuning is to be carried out after about 30 minutes have past, when the interval have stabilized, following switch-on of power.

② FEET (Feet change switch)

This instrument covers 3 octaves by its 37 keys. And, by the use of this FEET switch, the sound range that is covered may be shifted as shown in the drawing.

③ PW/PWM (pulse width/pulse width modulation)

PW: Pulse width

With the changeover switch set to PW, turn control.

This will cause the pulse width to change, thereby, causing the harmonic structure to change as well. Thus, it can be used as a sound source that differs from one of symmetric square waves.

PWM: Pulse width modulation

When the control is turned, with the changeover switch set to PWM, it will cause the pulse width to be modulated with the period set by the SPEED control of LFO.

④ LFO MOD

This modulates the oscillation frequency of VCO with the period of LFO, to render an effect resembling "vibrato".

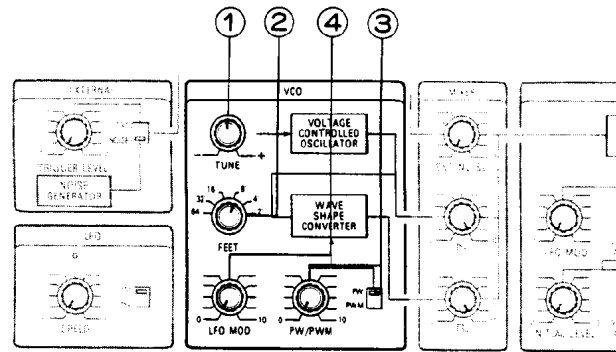

FEET

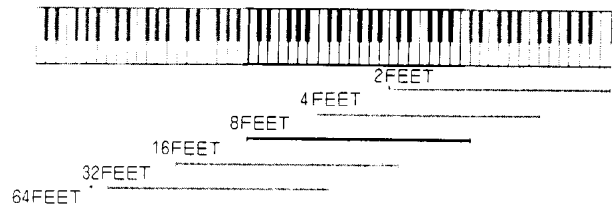

PW: Pulse width

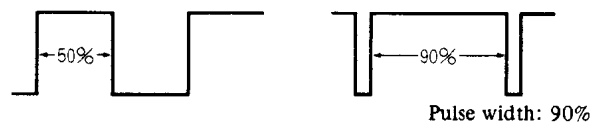

PWM: Pulse width modulation At maximum change

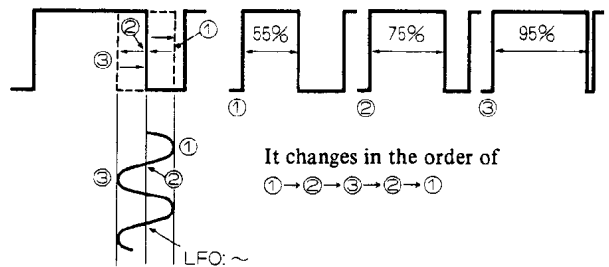

LFO

The LFO is a low frequency oscillator block that functions to give a periodic vibration to intervals, tone and volume with regard to the VCO, VCF and VCA blocks.

① SPEED

This is a control for adjusting the oscillation frequency. The variable range is from 0.1 to 100 Hz. The frequency becomes higher, the farther the control is turned clockwise. By varying the speed, it is possible to produce effects of different sensations.

② ~ / ~ CHANGE SWITCH

By changing the wave forms of LFO, different effects can be produced.

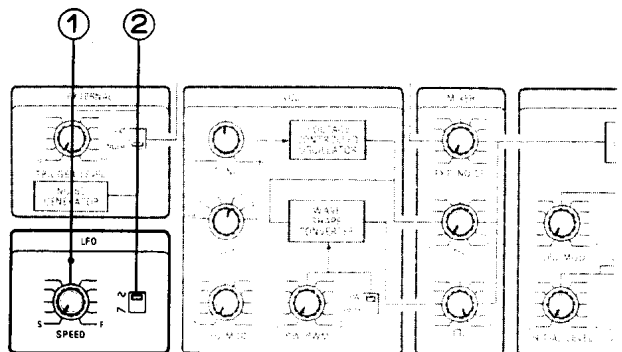

FUNCTIONS VCF

The tone is created by effecting control on the harmonic structure by passing the VCO signals through a filter.

① HPF/BPF/LPF FILTER SWITCH

HPF: HIGH-PASS FILTER

Frequency components that are higher than the cut off frequency set by means of CUT OFF FRQ are passed through this filter. It is employed, for example, when cutting the fundamental sound and controlling the low frequency range.

BPF: BAND PASS FILTER

The intermediate frequency components between the cut off frequencies are passed through this filter.

LPF: LOW-PASS FILTER

Frequency components lower than the cut off frequency are passed through this filter. This is a filter commonly used for synthesizers.

② CUT OFF FRQ (Cut off frequency)

Control the tone by adjusting the boundary between the portion to be passed through the filter and that which is to be cut off. This changes the harmonic structure of the sound source.

The more this control is turned clockwise, the higher the cut off frequency becomes.

- While in the LPF mode, if the CUT OFF FRQ control is turned too far in the counterclockwise direction, it may cause even the fundamental sound to be cut off, resulting in no sound at all.

③ RESONANCE

Turning of this RESONANCE control in the clockwise direction will cause the harmonics in the neighborhood of the cut off frequency to be emphasized, thereby giving even stronger characteristics to the tone.

④ EG-VCF (Envelope generator)

The change in tone, from the instant the key is depressed to the point the sound fades out, is made by this EG. This is achieved by varying the filter's cut off frequency with time.

INITIAL LEVEL (IL)

Set the harmonic structure for the point the sound starts when the key is depressed. The more the control is turned toward the "-5" side, sound will be started from a further lower cut off frequency.

ATTACK LEVEL (AL)

The maximum level up to which the harmonics structure is to be changed is set by this control. The farther control is turned toward the "+5" side, it will cause the harmonic structure to vary to a higher cut off frequency.

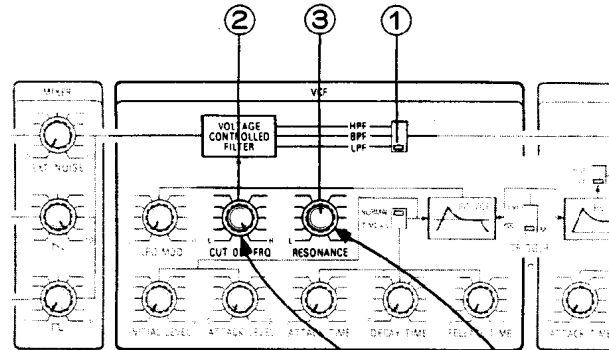

FILTERS

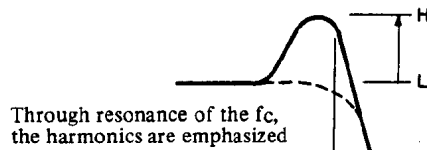
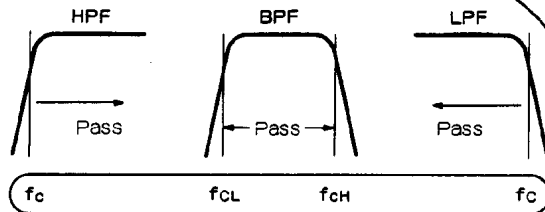

Through resonance of the f_c , the harmonics are emphasized

f_c : Cut off frequency

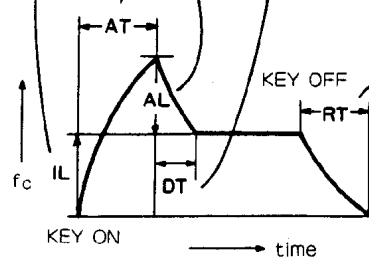
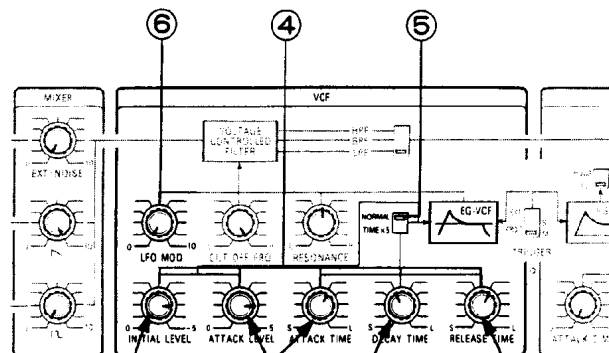

FUNCTIONS VCF/VCA

ATTACK TIME (A)

Sets the time it will take the harmonics structure to vary from IL to AL.

DECAY TIME (D)

Sets the time it will take the harmonic structure set at AL to settle down to the sustaining state set by means of the CUT OFF FRQ.

RELEASE TIME (RT)

Sets the time it will take from the instant the key is released to the time the harmonic structure returns to its state of the starting of sound.

① TRIGGER

Controls the start of the EG (envelope generator) of the VCF and VCA. When the trigger is applied, it will cause the trigger indicator to illuminate.

Set this to the KBD-side when using the keyboard, and to the EXT-side when using external signals.

EXT (External signals)

Controls start of EG by the use of external input. (See TRIGGER LEVEL.)

KBD-S (Single trigger)

After pressing a key, and then pressing the next key before the sound fades out (slur touch), the second sound will be produced by the envelope which, in turn, is produced by the trigger of the key that has been pressed first.

KBD-M (Multi trigger)

In the slur touch, a new envelop will start to take place by the trigger of the key that has been newly depressed.

⑤ NORMAL/TIME x 5

When positioned to "TIME x 5", it will cause the AT, DT and RT time to be increased to 5 times the NORMAL one, thereby enabling changes over a vaster range.

⑥ LFO MOD

Enables an effect similar to "growl" gained by modulating the cut off frequency of the VCF with LFO's period.

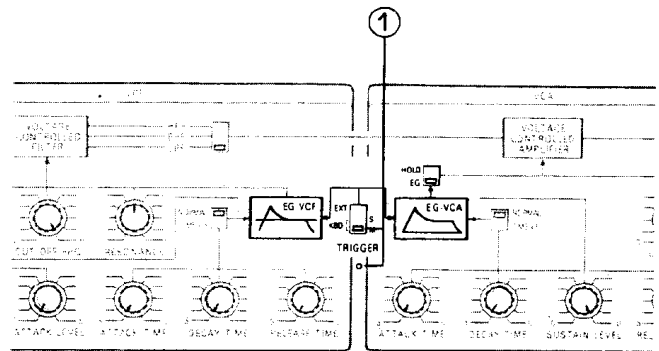

KBD-S

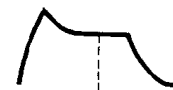

The interval will change at the next key but the envelope remains unchanged.

A envelope generated by the first key

KBD-M



A new envelope starts generating by the next key.

A envelope generated by the first key

VCA

The signals sent out from the VCF will be given a timewise variation in volume by means of the VCA's envelope generator

① HOLD/EG (Hold switch)

By setting this switch to the HOLD side, the interval of the key depressed immediately before setting of switch will be continued to be fed out, no matter where the EG control may be positioned to. This switch offers convenience for tuning and when sounds are to be produced for tentative purposes. Setting to the EG side will permit gaining of the volume variation set with the "A", "D", "S" and "R" control.

② EG-VCA (Envelope generator)

Similar to the VCF, the volume from the instant a sound is started up to the time it fades out is varied with time by setting the "A", "D", "S" and "R" controls. The envelope effect is gained by changing the amplification degree of the amplifier with time.

ATTACK TIME (AT)

Sets the time for the period from the time the key is depressed up to the time the sound reaches maximum.

FUNCTIONS VCA/EFFECT

DECAY TIME (DT)

Sets the time for the period from the time of maximum volume up to the time the volume settles down to the sustaining state set by the SUSTAIN LEVEL.

SUSTAIN LEVEL (SL)

Sets the SUSTAINING mode volume for the period while the key is depressed.

- When the SUSTAIN level is maximum, DECAY TIME will become irrelevant no matter where the control may be positioned to.

RELEASE TIME (RT)

Sets the time for the period from releasing of key up to fade-out of sound.

③ NORMAL/TIME x 5

When positioned to "TIME x 5", it will cause the AT, DT and RT time to be increased to 5 times the NORMAL one, thereby enabling changes over a vaster range.

④ LFO MOD

Enables an effect similar to "tremoro" gained by modulating the amplification degree of the VCA with LFO's period.

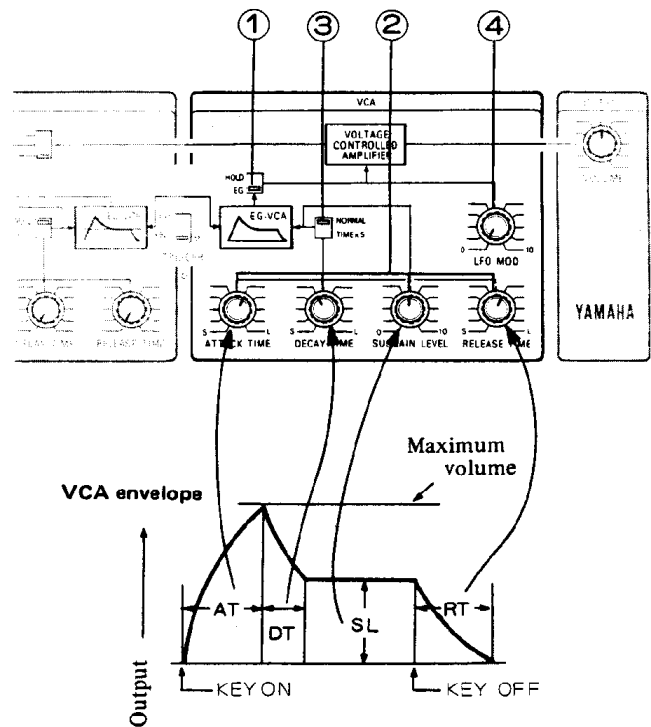

EFFECT

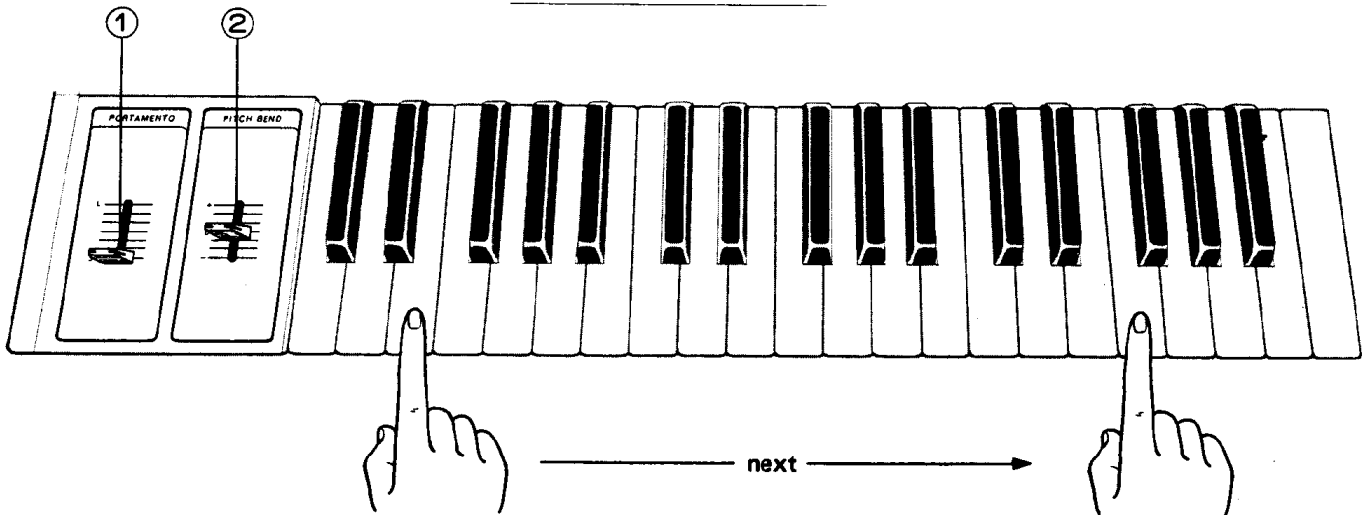

① PORTAMENTO

As shown in the drawing, when one key is depressed and then another key of another interval is depressed in succession, the interval can be shifted smoothly from the first interval to the next. The interval shifting time will become longer, the more the PORTAMENTO lever is set toward the "L" side.

② PITCH BEND

The pitch may be changed continuously by manual operation by sliding the PITCH BEND lever vertically.

When not in operation, the PITCH BEND lever should be positioned to the center click. The range of variation is within ± 1 octave.

HOW TO USE EXTERNAL TERMINAL

By connecting such external signals as those of an electric guitar and an electronic piano to the EXTERNAL terminal provided on the rear panel, such sound sources can be added to the VCF. At the same time, as it is possible to detect these wave forms and use them as trigger signals (equivalent to keyboard data for KEY-ON and KEY-OFF) to effect control of the start of the envelope generator (EG), it can be used for synthesizing operations (can function as a guitar synthesizer, etc.) by the use of external sound sources.

- It is also possible to control the keyboard by treating the external signals as a sound source, independent of the VCO as in the case of NOISE.
- When a trigger is to be applied with the use of external signals (when the EXT/KBD switch is set to EXT), keyboard performance will not be possible.

① EXTERNAL (External input signal)

A terminal from which external signals such as those of an electric guitar, electric piano, or the like, is to be fed in.

② 0/-20 INPUT SENSITIVITY CHANGE SWITCH

0 Used for high level inputs such as an electric guitar, electronic piano, etc.

-20 Used for low level inputs such as microphones.

③ EXT/NOISE (External input/noise)

The switch is to be set to the EXT side when external signals are used as the sound source.

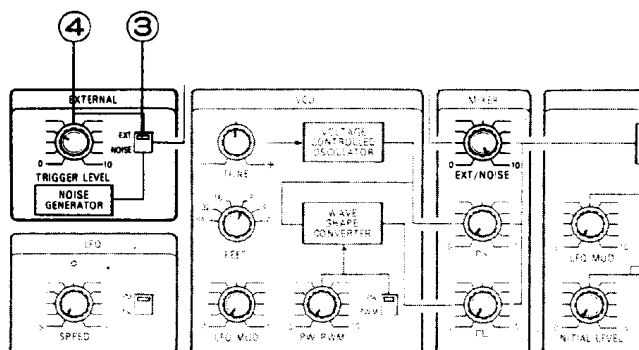
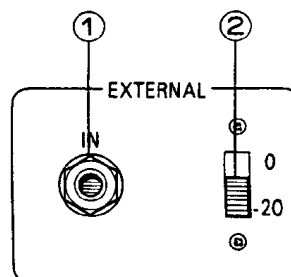

④ TRIGGER LEVEL

The most common way of setting is to set the trigger switch (EXT/KBD) to EXT, and then to set the TRIGGER LEVEL to the minimum level that will cause the trigger indicator to be illuminated.

WHEN USING 2 SETS OF SYNTHESIZERS

With the KEY VOLT and TRIGGER terminals provided on the rear panel, by transmitting the keyboard data of this CS-10 to the control block of another CS-10 (or another-type synthesizer provided with similar terminals), it is possible to use this instrument as a 2-system synthesizer.

① KEY VOLT

Keyboard data signals used for controlling the intervals oscillated by VCO, or the like.

② TRIGGER

Keyboard data that indicates the timing for depressing the key (KEY-ON) and for releasing it (KEY-OFF). It is used to effect control on the envelope generator (EG) of the VCF and VCA.

- The drawing at right shows connections for keyboard performances using Synthesizer 1, and effecting control with both Synthesizers 1 and 2.
- In carrying out connections, special care should be taken not to make such errors as connecting an OUT terminal to another OUT terminal as it will become the cause of troubles.

Synthesizer 1

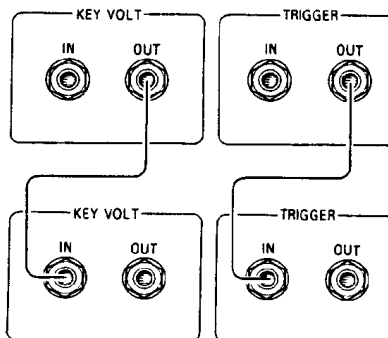
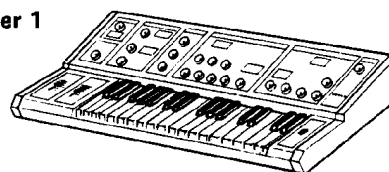

Synthesizer 2

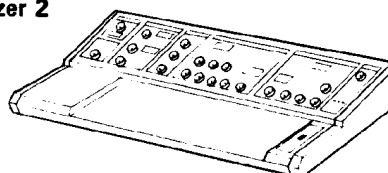

SEQUENCE OF OPERATION

BASIC SETTING

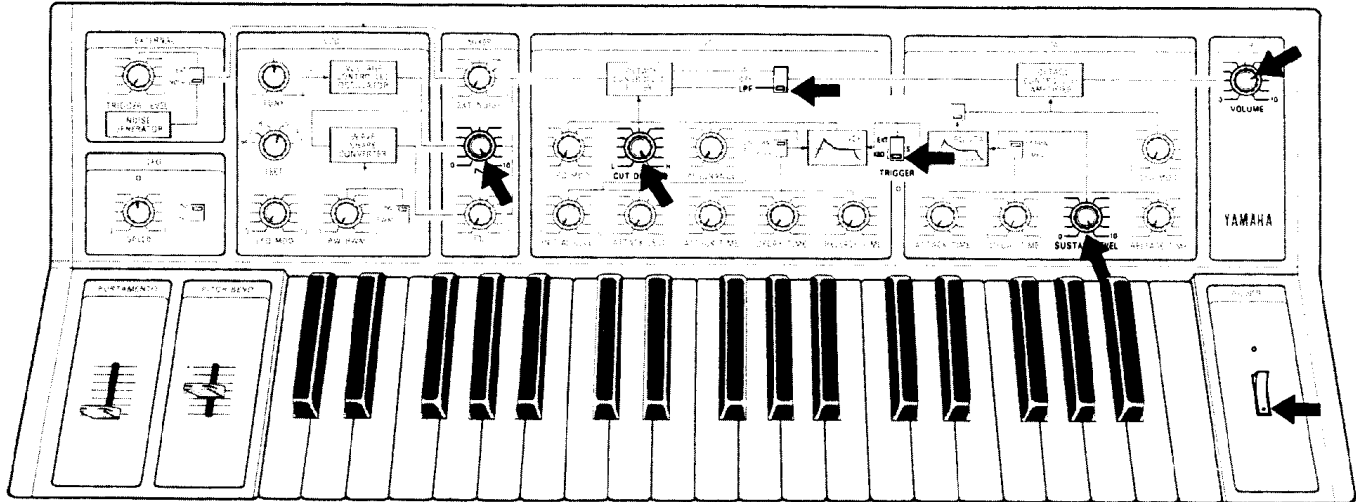

SETTING

- 1 Referring to "CONNECTION", set the synthesizer.
- 2 Switch on the switches of the synthesizer as well as of the amplifier and adjust the amplifier's VOLUME control to a best suited position.
- 3 Following switch-on of power, when about 30 minutes have past, carried out tuning.

SOUND MAKING

- 1 Prior to playing the synthesizer, you must start by making your own original sounds.
- 2 Flowing from the left side of the control panel toward the right, signals are controlled by means of the respective controls.
- 3 When a key is depressed, a signal corresponding to the keyboard's interval will be produced at the VCO block.
To allow the original oscillation signal to be fed out as it is (without being given any "spicing" by the VCF and VCA blocks), the controls of the VCF and VCA blocks should be set as shown in the above drawing.
- 4 **VCO BLOCK/MIXER BLOCK**
 - Select the sound source that will be used as the basic sound by means of the MIXER controls.
 - When the key is depressed, sound will be produced.
 - By the use of the FEET switch, determine the keyboard interval range.
- 5 **VCF block**
 - Sets up the basic harmonic structure. After selecting the filter with the HPF, BPF, or LPF

switch, the harmonic structure is produced by using the CUT OFF FRQ and RESONANCE controls.

- Next, a timewise variation is given to the harmonic structure by the use of EG-VCF (INITIAL LEVEL, ATTACK LEVEL, ATTACK TIME, DECAY TIME AND RELEASE TIME).

6 VCA block

- The volume for the period, from the start of the sound up to the time it fades out, is given a time-wise variation by the use of EG-VCA (ATTACK TIME, DECAY TIME, SUSTAIN LEVEL and RELEASE TIME).

7 LFO/EFFECT

- This functions to select the speed and wave form for the LFO block. If necessary, the LFO MOD of the VCO, VCF and VCA blocks are to be adjusted.
- Performance is rendered with variations by using the levers for PORTAMENTO and PITCH BEND effects.

- 8 **Steps 5 through 7** constitute quite basic steps for sound making. Actually, to make sounds that will fit those of your image, it is necessary to carry out repeated adjustments of the respective controls until a sound that best fits your image is created. By recording on the SOUND MEMO the positions of the respective controls of the original sound created in this manner, reproduction at any time will be possible.

BASIC SOUND MAKING OPERATIONS

To ensure proper setting of the controls of each block, it is not only necessary to have a proper understanding of the function of each control, but it is also necessary to understand how the controls are correlated.

The following describes the process of sound making while also describing the key points.

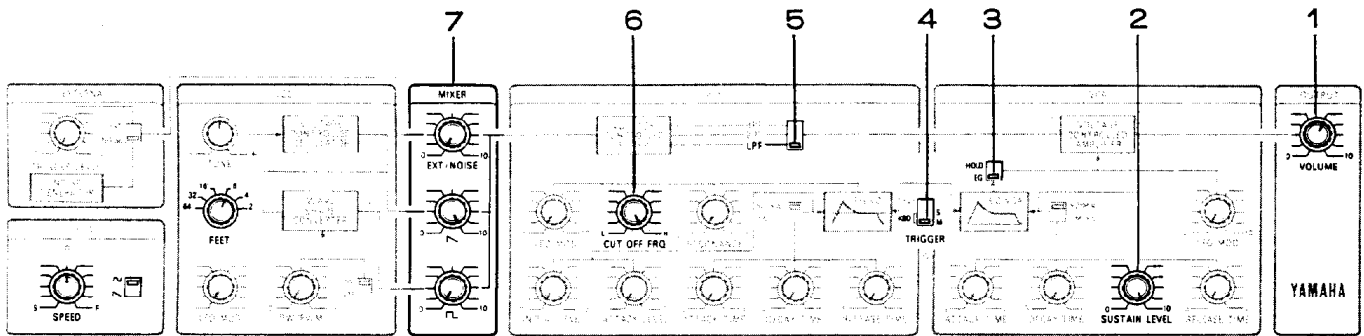

Fig. 1

HOW TO SELECT THE SOUND SOURCE

The matter of whether it is better to use the saw-tooth wave, or the square wave, as the sound source is decided after actually listening to the two sounds and comparing them. But in the case of making artificial sounds of musical instruments, excepting those of closed wind instruments such as the clarinet, it is most common to select saw-tooth waves having integral-multiple harmonics.

On the other hand, when sounds distinctly characteristic to the synthesizer (such as cosmos sounds) are to be made, use of square waves proves to be more effective. The sounds of saw-tooth waves and square wave should be compared by actually listening to both of them.

In order to do this, first set the controls in the manner of the basic setting illustrated in Fig. 1, and then switch the MIXER alternately over to “ \sphericalangle 1” and “ \sqcap 2”, depressing the keyboard each time to confirm the difference.

In this case, \sphericalangle 1 is to be set to “0”, while \sqcap 2 is to be set to maximum. (Fig. 2)

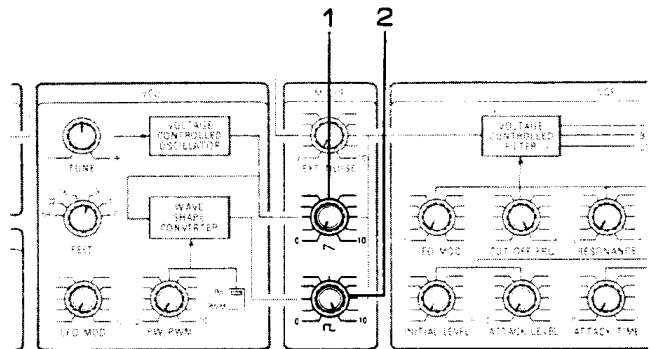

Fig. 2

VCF BLOCK

The more the harmonics of the saw-tooth wave, or square wave, increases to a higher order, the smaller the amplitude will become. Accordingly, the more the harmonics are of a lower order, the the tone-determining factor will become larger.

For example, when the cut off frequency is set to a high level on the “H” side with the filter set to LPF 1, no marked change will be observed in the tone even when the cut off frequency is controlled by the EG, or LFO. On the other hand, when the cut off frequency is set so that cut off will take place even down to low-order harmonics, the EG and LFO effects will become marked. Confirm this by using the LFO MOD 2. First, with the CUT OFF FRQ 3 fully turned clockwise, slowly turn the LFO MOD 2 control. Then,

position the CUT OFF FRQ 2 to the center and turn the LFO MOD control in the same manner. You will most probably see that the position at which the LFO's modulated sound can be confirmed will differ vastly. (Fig. 3)

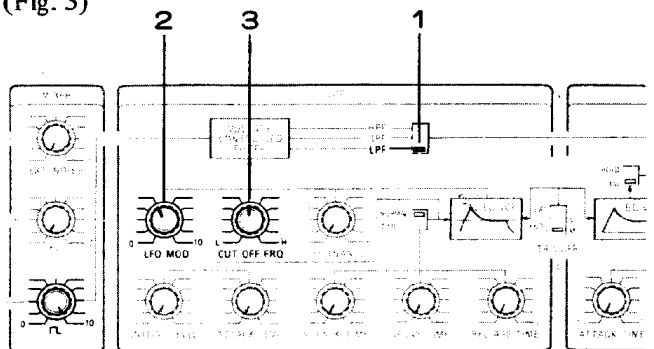

Fig. 3

Now, restore the LFO 2 to its original position and apply PWM by setting the PW/PWM 4 switch to PWM. Turn control 5 to the center. You will see that a tone differing from that of LFO MOD will be gained this way. Next, turn RESONANCE fully clockwise to emphasize the change in the tone. Now, let us control the EG, using this tone.

To increase the change in tone, set IL 1 and AL 2 respectively to “-5” and “+5” (Maximum).

In this state, no change will appear in the tone when the key is depressed. Turn AT 3 and DT 4 fully clockwise. Depress a key. By listening, have you noticed that the tone has changed in the same manner of EG's curve 5?

Next, let us apply a change to the tone, following the releasing of the key. Turn RT 6 fully clockwise. Have you noticed that no RT 6 effect will be seen here? The sound will disappear the instant the finger is released from the keyboard. (Fig. 5)

VCA BLOCK

You have seen that the RT of VCF appears to be somehow correlated to the VCA. The correlation of the VCF's EG and VCA's EG is not confined to the RT alone.

Generally, in musical instruments, it takes a certain time for the sound to reach its maximum level from the time the sound is started to be heard, and at the same time the tone at maximum volume will contain harmonics of the highest order.

In this way, generally, tone variation and volume variation agree with each other. So, as in the case of the VCF, turn the AT 1, DT 2 and RT 3 of the VCA fully clockwise. However, since SL 4 is at the maximum level in this state, no matter how DT 2 is adjusted, no effect will be produced. Thus, SL 4 should be turned down to around the middle. (Fig. 6)

OUTPUT VOLUME

In the synthesizer, provided VOLUME 1 is held at a constant level, the maximum value (peak level) of amplitude will always be maintained constant. However, in practice, due to the difference in the wave forms, the volume will sound different to one's ears. Thus, it is necessary to make final adjustments of the VOLUME 1.

This completes the jobs required for sound making. This is a special example of sound making introduced to help the user understand the functions of each controls. Thus, when you have fully understood the functions of each block and each control, it is time for you to make your challenge in creating your own original sounds.

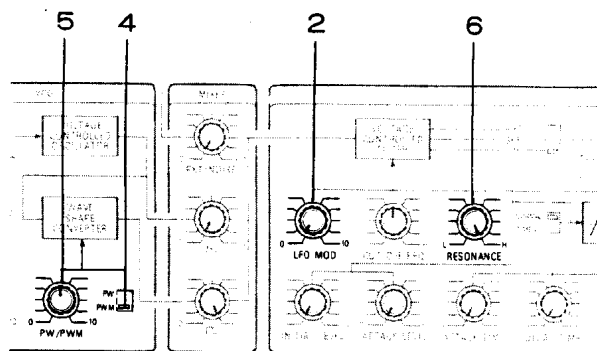

Fig. 4

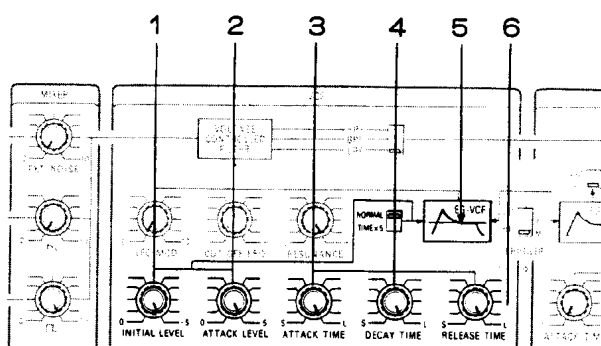

Fig. 5

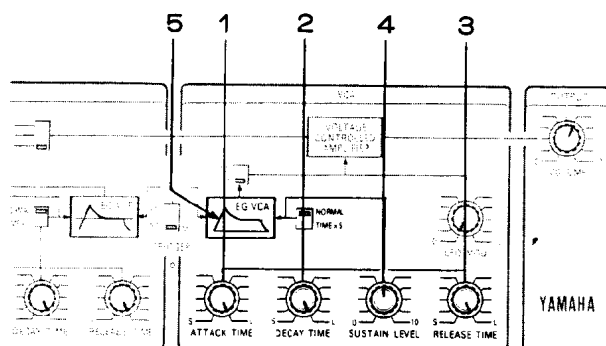

Fig. 6

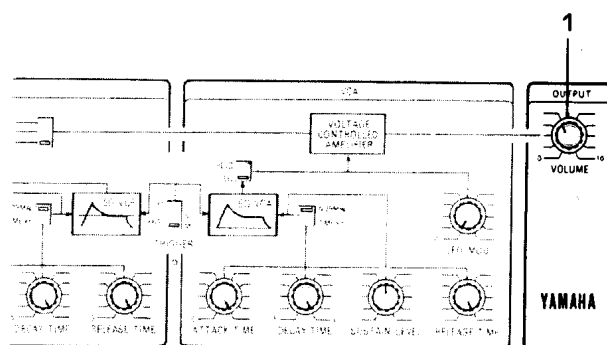
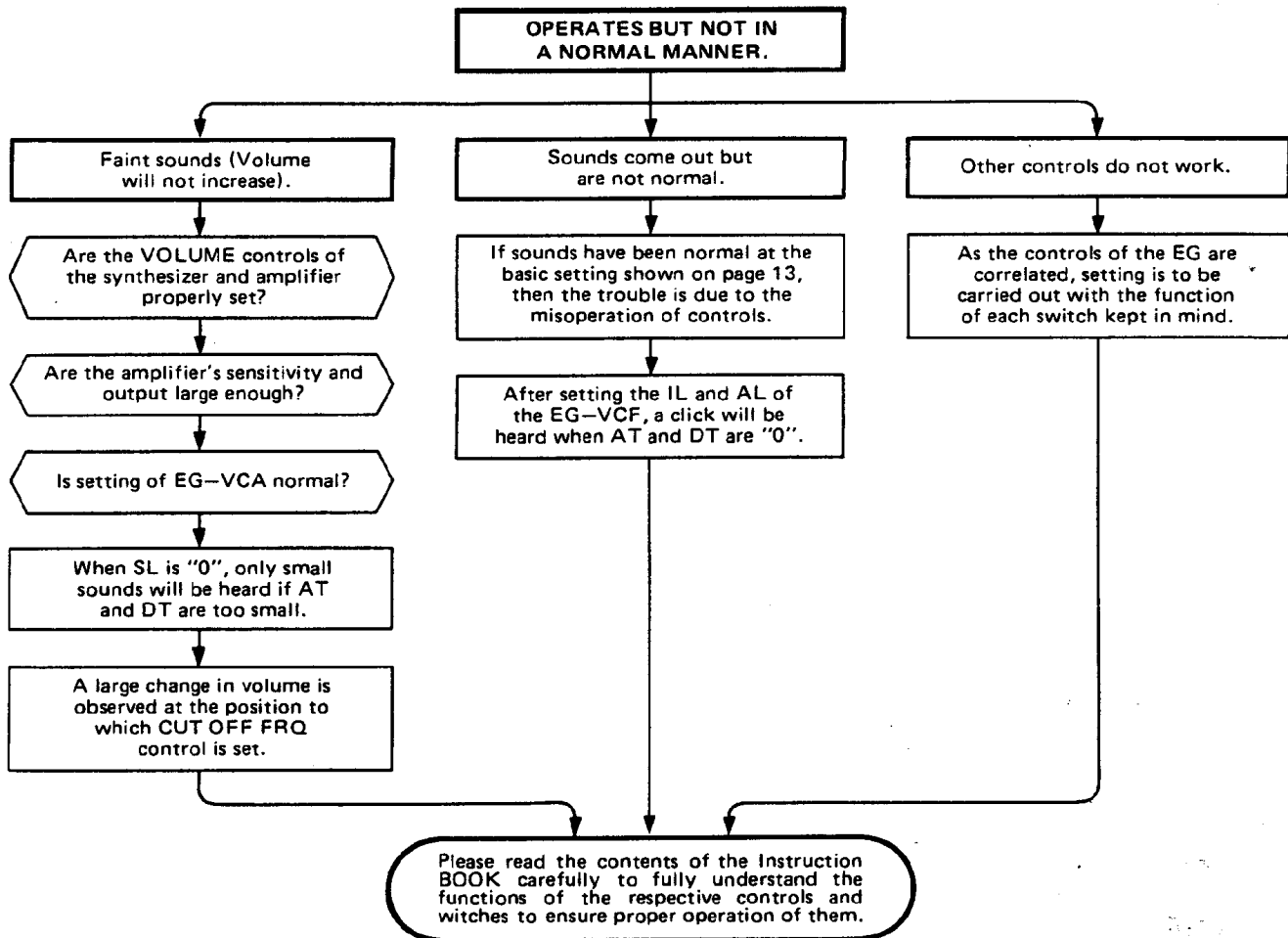
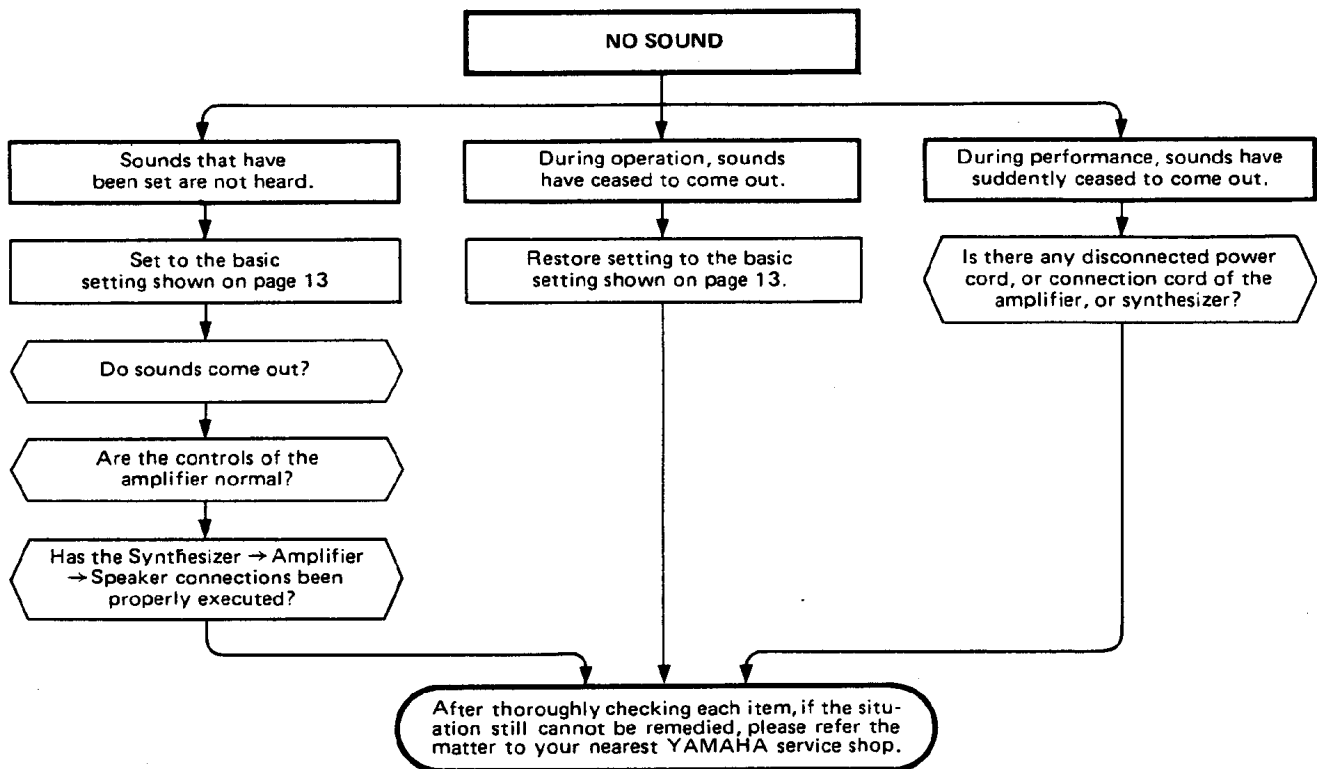
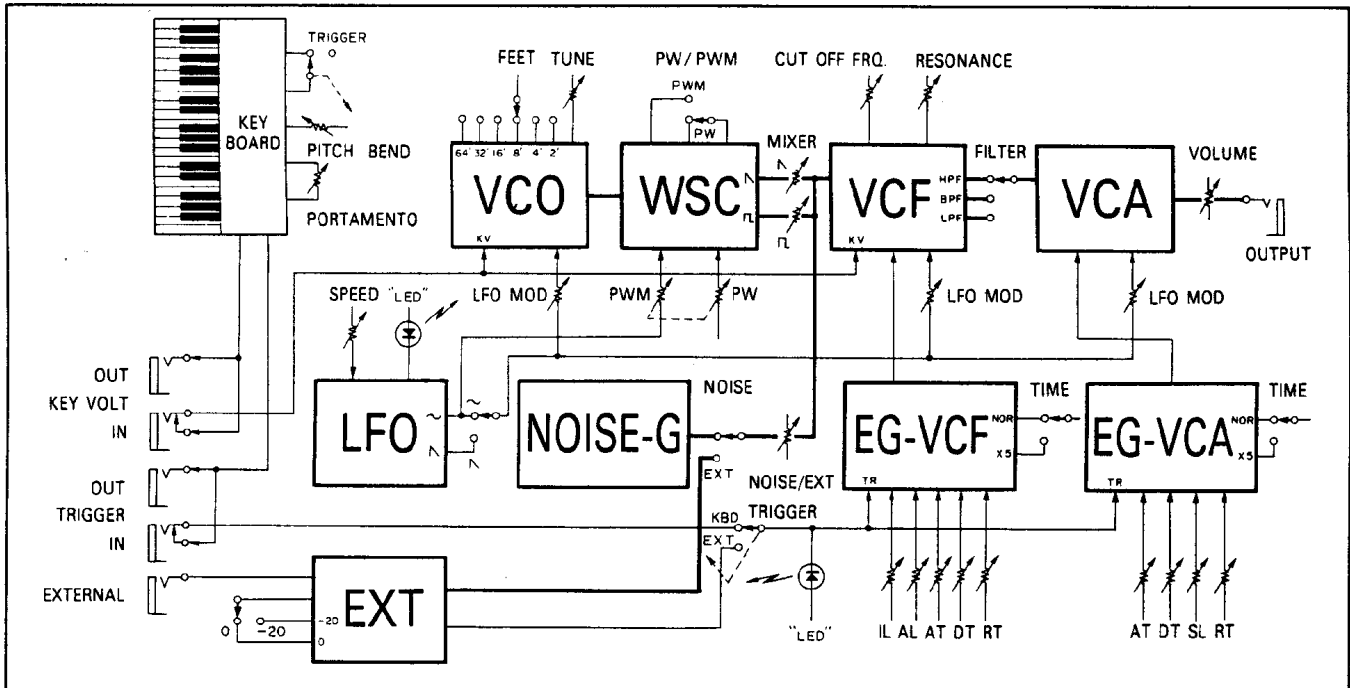

Fig. 7

TROUBLE SHOOTING



BLOCK DIAGRAM/SPECIFICATIONS



SPECIFICATIONS

Keyboard 37 keys, 3 octaves

CONTROLS

VCO FEET: 2', 4', 8', 16', 32', 64'
 TUNE: + 50 to -50 cents
 LFO MOD: + 60 cents (Max.)
 -60 cents
 PW: 50 ~ 90%
 PWM: 75 ± 20% at Max. (LFO SINE)
 PORTAMENTO: SHORT ~ LONG
 4 sec. at LONG

PITCH BEND: + 1 oct.
 -1 oct.

OUTPUT WAVE FORM:

VCF CUT OFF FRQ
 RESONANCE: Q = 10 at Max.
 LFO MOD ± 3 OCT
 EG: IL 0 ~ -5
 AL 0 ~ + 5
 AT 1 msec. ~ 1 sec.
 DT 10 m sec. ~ 10 sec.
 RT 10 m sec. ~ 10 sec.
 EG TIME: NORMAL x 5
 OUTPUT: Changeover of
 LPT, BPF, HPF

VCA LFO MOD: AM 100 % at Max.
 EG: AT 1 m sec. ~ 1 sec.
 DT 10 m sec. ~ 10 sec.
 SL 0 ~ 10
 RT 10 m sec. ~ 10 sec.
 EG: TIME: NORMAL x 5
 VOLUME: 0 ~ Max.
 TRIGGER SWITCHOVER

EXT: TRIGGER ON WITH EXT IN
 KBD

SINGLE: FOR KBD SLUR, TRIGGER
 ON FOR ONLY BEGINNING.
 MULT: TRIGGER ON CONSTANTLY

LFO SPEED: 0.1 Hz ~ 100 Hz
 WAVE FORM:
 SWITCHOVER BETWEEN

EXT TRIGGER LEVEL: ON-OFF
 SETTING OF TRIGGER
 0/-20: SWITCHOVER AT
 20 dB SENSITIVITY

NOISE WHITE NOISE

POWER SOURCE 110, 130, 220 or 240V
 selectable 50/60Hz

POWER CONSUMPTION 12 watts

EXTERNAL APPEARANCE

DIMENSIONS: 710(W) x 290(D) x 155(H) (mm)
 28(W) x 11-7/16 x 6-1/8 (in.)

WEIGHT: APPROX. 8 kg
 (17.8 lbs)

SOUND MEMO

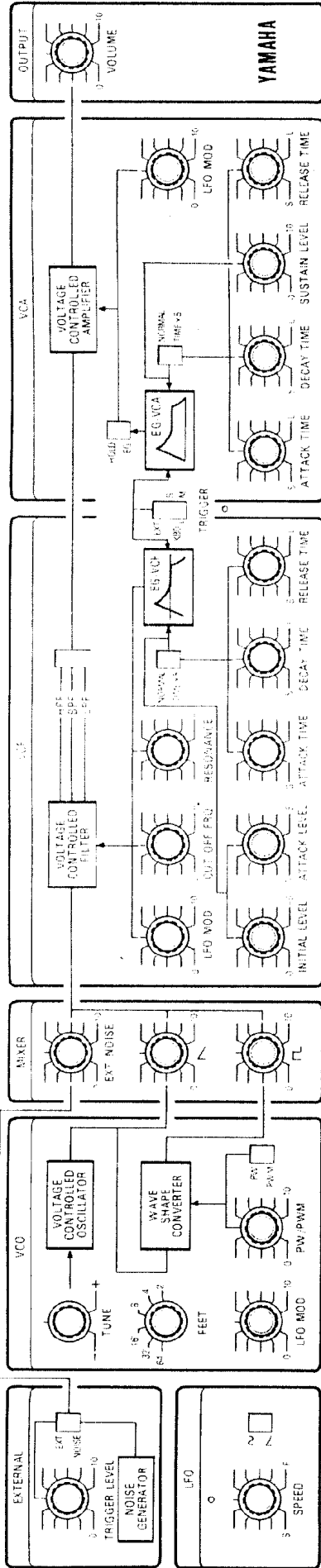

DATE: / /

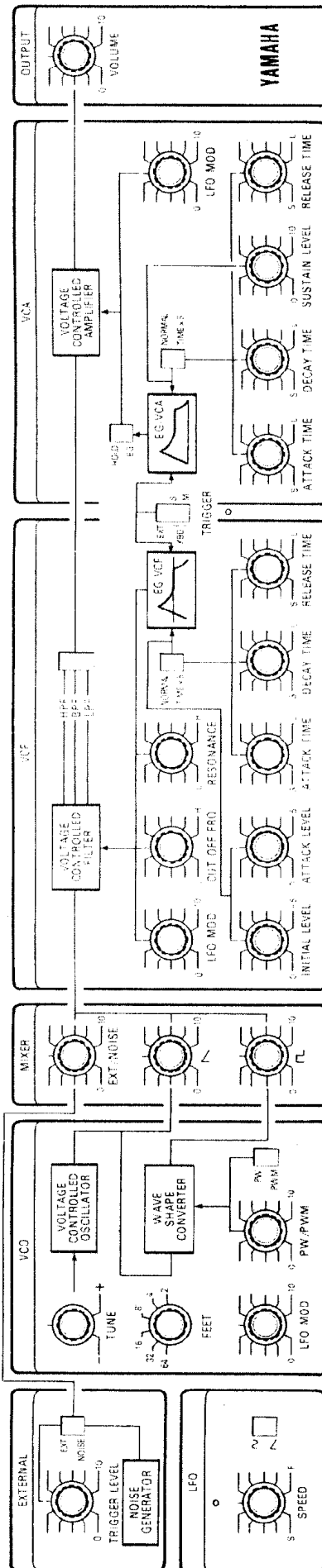

DATE: / /

SINCE 1887  **YAMAHA**
NIPPON GAKKI CO., LTD. HAMAMATSU, JAPAN