

Electric Violin

YEV104/YEV105
YEV104PRO/YEV105PRO

Электроскрипка
电小提琴

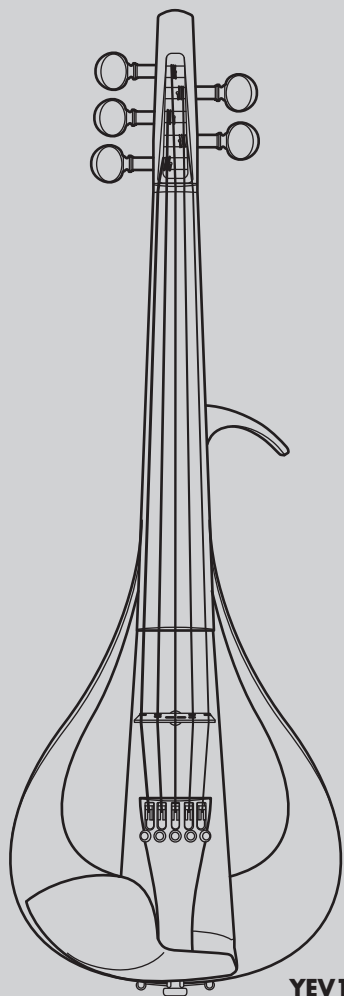

YEV105

取扱説明書

Owner's Manual

Benutzerhandbuch

Mode d'emploi

Manuale di istruzioni

Manual de instrucciones

Manual do Proprietário

Руководство пользователя

使用说明书

使用說明書

사용 설명서

JA	EN	DE	FR	IT	ES	PT
RU	ZH-CN	ZH-TW	KO			

日本語

English

Deutsch

Français

Italiano

Español

Português

Русский

简体中文

繁體中文

한국어

MEMO

Electric Violin

YEV104/YEV105

YEV104PRO/YEV105PRO

Owner's Manual

English

Thank you for purchasing the Yamaha Electric Violin.

The YEV104/YEV105/YEV104PRO/YEV105PRO are a new generation of Electric Violins delivering high performance that meet the demands of stage use.

The instrument incorporates a beautiful, unique shape crafted with Yamaha's advanced wood processing technologies, and utilizes a simple pickup system that delivers a passive signal to the output jack. In order to obtain maximum performance and enjoyment from this instrument, we urge you to read this Owner's Manual thoroughly before using the instrument. We recommend that you keep it in a convenient place for future reference.

Contents

PRECAUTIONS	5
Parts Diagram	6
Set up	8
Tuning and Changing the Strings	8
The Shoulder Rest.....	11
Specifications	11

SPECIAL MESSAGE SECTION

This product should be used only with the components supplied or; a cart, rack, or stand that is recommended by Yamaha. If a cart, etc., is used, please observe all safety markings and instructions that accompany the accessory product.

SPECIFICATIONS SUBJECT TO CHANGE:

The information contained in this manual is believed to be correct at the time of printing. However, Yamaha reserves the right to change or modify any of the specifications without notice or obligation to update existing units.

Do not attempt to service this product beyond that described in the user-maintenance instructions. All other servicing should be referred to qualified service personnel.

This product, either alone or in combination with an amplifier and headphones or speaker/s, may be capable of producing sound levels that could cause permanent hearing loss. DO NOT operate for long periods of time at a high volume level or at a level that is uncomfortable. If you experience any hearing loss or ringing in the ears, you should consult an audiologist.

IMPORTANT: The louder the sound, the shorter the time period before damage occurs.

NOTICE: Service charges incurred due to a lack of knowledge relating to how a function or effect works (when the unit is operating as designed) are not covered by the manufacturer's warranty, and are therefore the owner's responsibility. Please study this manual carefully and consult your dealer before requesting service.

ENVIRONMENTAL ISSUES: Yamaha strives to produce products that are both user safe and environmentally friendly. We sincerely believe that our products and the production methods used to produce them meet these goals. In keeping with both the letter and the spirit of the law, we want you to be aware of the following:

Disposal Notice: Should this product become damaged beyond repair, or for some reason its useful life is considered to be at an end, please observe all local, state, and federal regulations that relate to the disposal of products that contain lead, plastics, etc. If your dealer is unable to assist you, please contact Yamaha directly.

NAMEPLATE LOCATION: The nameplate is located on the back of the product. The model number, serial number, etc., are located on this plate. You should record the model number, serial number, and the date of purchase in the spaces provided below and retain this manual as a permanent record of your purchase.

Model

Serial No.

Purchase Date

PLEASE KEEP THIS MANUAL

Information for Users on Collection and Disposal of Old Equipment



This symbol on the products, packaging, and/or accompanying documents means that used electrical and electronic products should not be mixed with general household waste.

For proper treatment, recovery and recycling of old products, please take them to applicable collection points, in accordance with your national legislation and the Directives 2002/96/EC.

By disposing of these products correctly, you will help to save valuable resources and prevent any potential negative effects on human health and the environment which could otherwise arise from inappropriate waste handling.

For more information about collection and recycling of old products, please contact your local municipality, your waste disposal service or the point of sale where you purchased the items.

[For business users in the European Union]

If you wish to discard electrical and electronic equipment, please contact your dealer or supplier for further information.

[Information on Disposal in other Countries outside the European Union]

This symbol is only valid in the European Union. If you wish to discard these items, please contact your local authorities or dealer and ask for the correct method of disposal.

PRECAUTIONS

PLEASE READ CAREFULLY BEFORE PROCEEDING

Please keep this manual in a safe and handy place for future reference.



WARNING

Always follow the basic precautions listed below to avoid the possibility of serious injury or even death from electrical shock, short-circuiting, damages, fire or other hazards. These precautions include, but are not limited to, the following:

Do not open

- This instrument contains no user-serviceable parts. Do not open the instrument or attempt to disassemble or modify the internal components in any way. If it should appear to be malfunctioning, discontinue use immediately and have it inspected by qualified Yamaha service personnel.

Water warning

- Do not expose the instrument to rain, use it near water or in damp or wet conditions.



CAUTION

Always follow the basic precautions listed below to avoid the possibility of physical injury to you or others, or damage to the instrument or other property. These precautions include, but are not limited to, the following:

Connections

- Before connecting the instrument to other electronic components, turn off the power for all components. Before turning the power on or off for all components, set all volume levels to minimum.

Location

- Do not expose to direct sunlight (in a car during the day), high temperatures such as near a stove, or extremely low temperatures, and do not expose to vibrations or dust to prevent damage to the internal components or disfiguration.
- Do not place the instrument in an unstable position where it might accidentally fall over.
- Before moving the instrument, remove all connected cables, to prevent damage to the cables or injury to anyone who might trip over them.

Handling caution

- If cleaning is required, wipe with a soft cloth. Do not use thinners, solvents, cleaning fluids, or wipes soaked with chemicals. Also, do not place vinyl or plastic products on the instrument. Doing so can cause discoloration/deterioration.
- Do not rest your weight on, or place heavy objects on the instrument, and do not use excessive force on the buttons, switches or connectors.
- Do not use the instrument for a long period of time at a high or uncomfortable volume level, since this can cause permanent hearing loss. If you experience any hearing loss or ringing in the ears, consult a physician.
- Take care not to pierce your finger with the end of the string. String ends are sharp and may cause injury.
- Never hold the instrument close to your face when adjusting or replacing strings. A string may unexpectedly break damaging your eyes.

Yamaha cannot be held responsible for damage caused by improper use or modifications to the instrument.

Parts Diagram

[Main Unit]

● Front

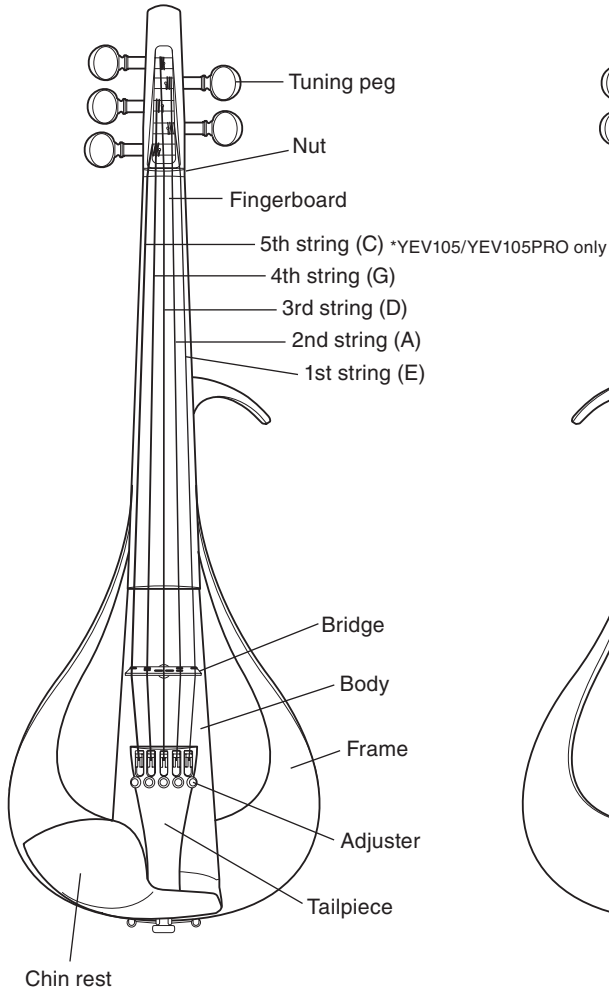

● Rear

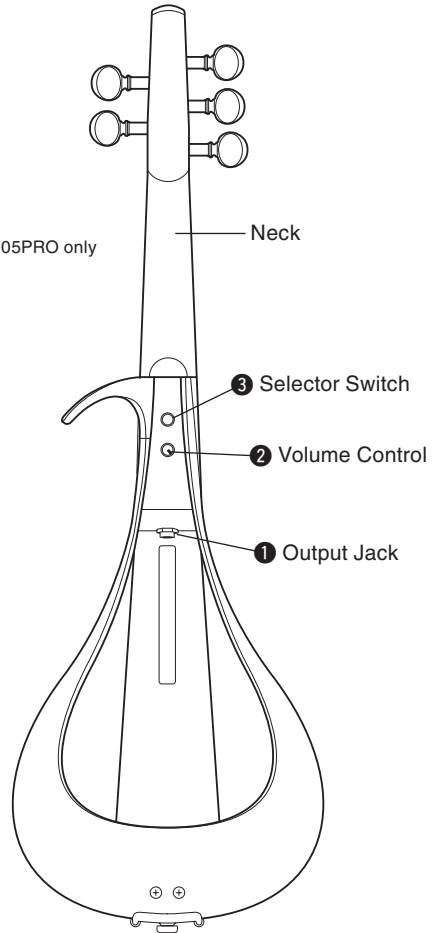

The YEV105/YEV105PRO (5-string model) is used in the illustration. The number of strings/tuners, and the shape of the fingerboard and tailpiece are different on the YEV104/YEV104PRO (4-string model).

● Rear Control Section

① Output Jack

This is the pickup's passive signal output jack.

Connect this jack to a device with a high-impedance input such as a preamplifier, direct box, or musical instrument amplifier.



- * The input impedance of the first device (preamp, direct box, etc.) the instrument connects to has a major influence on the sound quality produced by the speakers. In order to obtain the maximum performance from the instrument, we recommend connecting to a device with an input impedance of more than 1MΩ.
- * Since signal strength decreases in relation to the length of the cable connecting the instrument to the first device, we recommend using the shortest possible cable length that does not interfere with your performance.

Using an equalizer, etc., to cut frequencies below the instrument's lowest pitch (around 200Hz for the G on the 4-string and about 150Hz for the C on the 5-string) can reduce unwanted noise such as bow return, hum, etc., with minimal impact on sound quality.

② Volume Control

Adjusts the volume. Turning to the right increases volume, turning to the left decreases. (The volume control is active only when the output selector switch is depressed ().)

③ Selector Switch (Volume Control Enable Switch)

Selects whether the signal output path goes from the pickup straight to the output jack (direct out: ), or passes through the volume control ().

- * The direct out signal offers the full tonal potential of the instrument, with low-end tone that is fat and punchy.
- * Noise can occur when switching the selector. Before switching, lower the volume on the amplifier, external equipment, etc.



CAUTION

- Before connecting the Electric Violin to any external equipment, make sure the power is switched OFF or the volume is fully lowered on all devices. Failure to do so can result in a loud sound that can damage equipment or your hearing.

Set up

■ Tuning and Changing the Strings

Because the bridge includes a built-in pickup, which is connected to the body with a thin cable, the instrument ships from the factory with the bridge laying down. First, set up the bridge and then proceed with tuning. As the strings get old, sound quality will gradually decrease, and it will become difficult to tune the instrument. Change the strings as soon as you think they are getting old.

⚠ CAUTION

- The end of the strings are sharp and can cut fingers. Use caution when changing strings.
 - When changing or adjusting strings, do not put your face close to the instrument. The string may suddenly break resulting in eye or other unexpected injuries.
- The lower side of the bridge supports the 1st string (E), the higher side supports the 4th string (G)/5th string (C). Please note the bridge orientation and center the bridge over the pickup cable hole as shown in the illustration below.

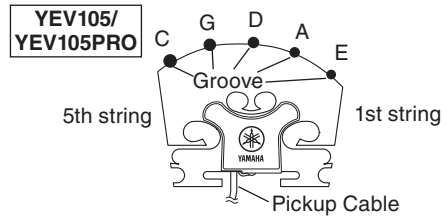
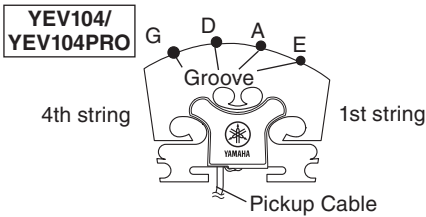

* The illustrations show the view looking from the tailpiece.

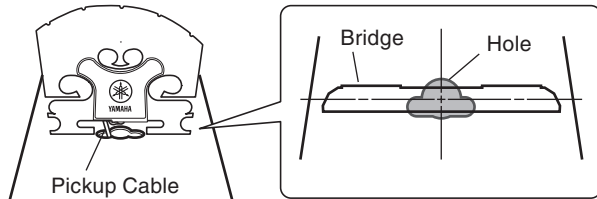

- Ensure that the bridge stands vertically. If it leans to one side, use both hands to adjust. Make sure that each string passes over the corresponding slits in the bridge.

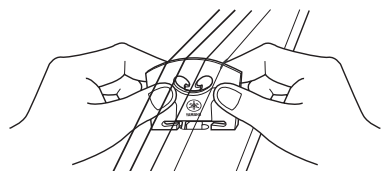
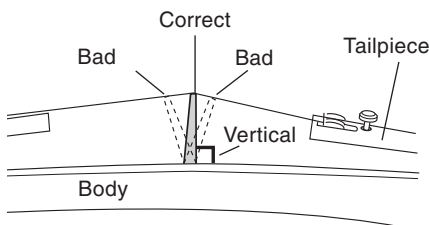

[Bridge is placed vertically]

NOTICE

Make sure that the strings are resting in their appropriate grooves in the bridge when playing the instrument.

Strings may come out of their grooves when adjusting the bridge or changing strings. Since the 1st (E) and 4th (G)/5th (C) strings tend to come out of their grooves easily, use your fingers to hold the strings gently in place when tuning the instrument.

Also, the 1st (E) string is fitted with a protective tube. Make sure that the tube rests on the bridge.

Always make sure that the bridge is standing vertically, whether the instrument is being played or stored. (see diagram on page 8)

Even if the bridge is standing vertically before tuning, it may tilt during the tuning process. If so, readjust the bridge so it stands vertically.

It is very important that the bridge stands vertically. If it leans in either direction it will impair the sound and risk damaging the instrument.

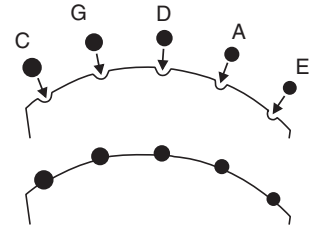

[Make sure that the strings do not come out of their grooves]

Protective tube on the 1st (E) string

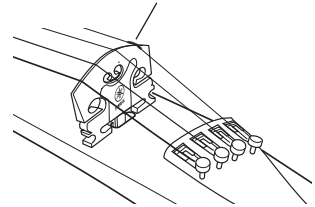

- String tunings are, 1st string E, 2nd string A, 3rd string D, 4th string G, 5th string C (YEV105/YEV105PRO only). Rotate the tuning peg to tune. Use a piano, tuning fork, or tuner to tune the instrument.
- Finally, use the adjuster to fine tune the strings.

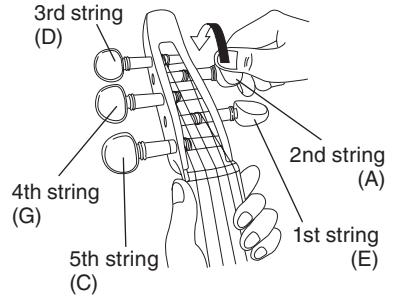
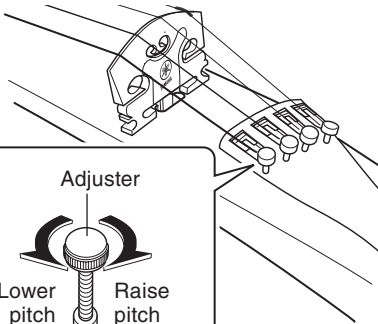

YEV105/
YEV105PRO

NOTICE

If the adjuster is too loose, it could produce noise while playing.

Don't loosen too much.

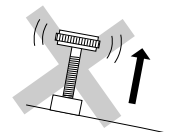

NOTICE

- When the instrument is not going to be used for an extended period of time, loosen the strings until the pitch drops a whole tone.
- Before using the instrument, make sure that the bridge is positioned vertically. Damage to the bridge and poor sound quality may result if the bridge is not properly positioned.

● Winding the Strings

(Please refer to this section when changing the strings)

- 1 Before you string the instrument, set the adjuster so that it is in the middle of its adjustment range. (All adjusters)
- 2 Place the ball (on the end of the string) in the notch on the adjuster. Make sure the ball is properly inserted in the adjuster's notch.

The adjuster should be set to the middle of its adjustment range.

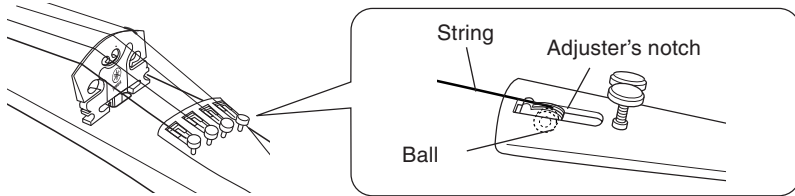
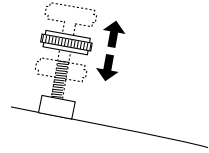

⚠ CAUTION

Do not use loop end E strings. It may damage the strings or fine tuner, and can cause injury.

- 3 After threading the string through the hole in the tuning peg, turn the tuning peg making one wrap on one side of the hole and the remaining wraps on the other side as shown in the diagram on the right.

Winding the 3rd,
4th and 5th strings

Winding the 1st and
2nd strings

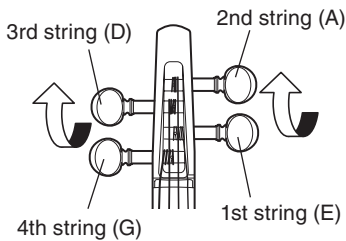
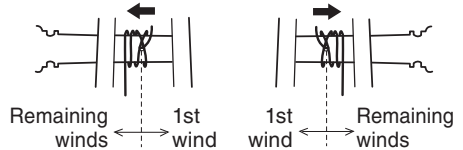

YEV104/
YEV104PRO

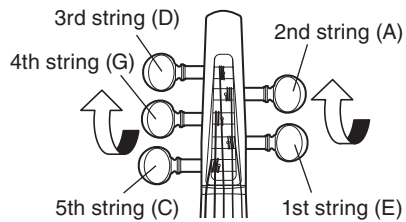

YEV105/
YEV105PRO

NOTICE

- The YEV104PRO and YEV105PRO feature Wittner Finetune-Pegs. When threading the string through the hole in the tuning peg, insert the string in such a direction so that it will not bend sharply.
- Do not pull the tuning peg knobs forcefully. Doing so might cause damage.

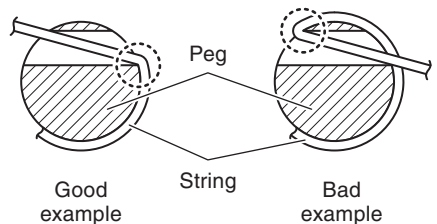

■ The Shoulder Rest

A commercially available violin shoulder rest (4/4 size) can be attached to the instrument.

* Some shoulder rests are incompatible (air cushion type, etc.).

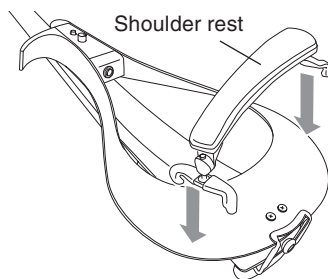

Specifications

Neck	Maple
Body	Spruce + Mahogany + Maple (YEV104/YEV105) Spruce + Maple (YEV104PRO/YEV105PRO)
Tuning Pegs	Ebony (YEV104/YEV105) Wittner Finetune-Peg (YEV104PRO/YEV105PRO)
Bridge	Maple (Built-in Pickup Type)
Frame	Walnut
Tailpiece	Synthetic Resin (equipped with adjusters)
Strings	Ball-end type violin strings (D'Addario Zyex) * D'Addario Helicore on the 5-string YEV105/YEV105PRO only
Pickup	Bridge w/ Built-in Piezo-electric Pickup
Controls	• Volume Control • Selector Switch (Volume Control activation switch)
Output Jack	Passive Output (Φ6.3 Standard Monaural)
String Length	328 mm (12-15/16")
Dimensions	YEV104/YEV104PRO : 592 (L) x 204 (W) x 111 (H) mm 23-5/16" (L) x 8-1/16" (W) x 4-3/8" (H) YEV105/YEV105PRO : 607 (L) x 204 (W) x 120 (H) mm 23-7/8" (L) x 8-1/16" (W) x 4-3/4" (H)
Weight	YEV104 : approximately 560 g (1 lbs. 4 oz.) YEV105 : approximately 590 g (1 lbs. 5 oz.) YEV104PRO : approximately 510 g (1 lbs. 2 oz.) YEV105PRO : approximately 550 g (1 lbs. 3 oz.)
Accessory	Owner's Manual (this booklet)

* The contents of this manual apply to the latest specifications as of the publishing date.
To obtain the latest manual, access the Yamaha website then download the manual file.

雅马哈乐器音响（中国）投资有限公司
上海市静安区新闸路1818号云和大厦2楼
客户服务热线：4000517700
公司网址：<http://www.yamaha.com.cn>

厂名：萧山雅马哈乐器有限公司
厂址：浙江省杭州市萧山经济技术开发区红泰六路777号

YAMAHA CORPORATION

10-1 Nakazawa-cho, Chuo-ku, Hamamatsu, 430-8650 Japan

© 2016 Yamaha Corporation

Published 03/2024 改版 IP-D1



VGZ9010 版次 2403 R7