

MCR-750

(BRX-750 + NS-BP150)

Micro Component System



OWNER'S MANUAL
MANUAL DE INSTRUCCIONES
使用说明书

Made for

 iPod  iPhone  iPad

CAUTION

Use of controls or adjustments or performance of procedures other than those specified herein may result in hazardous radiation exposure.

PRECAUCIÓN

El uso de los controles, los ajustes o los procedimientos que no se especifican en este manual pueden causar una exposición peligrosa a la radiación.

注意

使用此处指定外的控制或调节以及进行指定外的操作都有可能引起有害的辐射暴露。

LASER Specification:

Class 1 LASER Product

Wave length: 790 nm (CDs)/658 nm (DVDs)/405 nm (BDs)

Laser output: max. 1 mW

Especificaciones LÁSER:

Producto LÁSER de Clase 1

Longitud de onda: 790 nm (CD)/658 nm (DVD)/405 nm (BD)

Salida de láser: máxima de 1 mW

激光

波长: 790 nm (CDs)/658nm (DVDs)/405nm (BDs)

输出功率: 最大 1mW

The laser component in this product is capable of emitting radiation exceeding the limit for Class 1.

El componente láser de este producto es capaz de emitir radiación que sobrepasa el límite establecido para la clase 1.

本机激光部件的辐射级别大于 1 级限度。

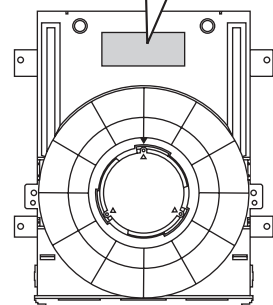
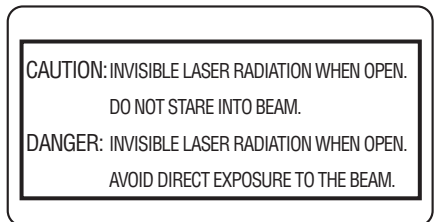
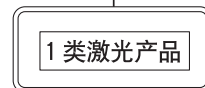
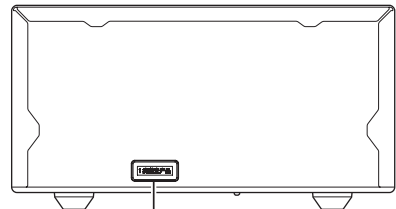
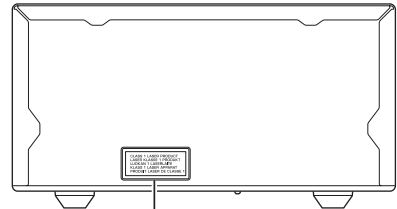

CAUTION: READ THIS BEFORE OPERATING YOUR UNIT.

- 1 To assure the finest performance, please read this manual carefully. Keep it in a safe place for future reference.
- 2 Install this sound system in a well ventilated, cool, dry, clean place - away from direct sunlight, heat sources, vibration, dust, moisture, and/or cold. For proper ventilation, allow the following minimum clearances.
Top: 10 cm
Rear: 10 cm
Sides: 10 cm
- 3 Locate this unit away from other electrical appliances, motors, or transformers to avoid humming sounds.
- 4 Do not expose this unit to sudden temperature changes from cold to hot, and do not locate this unit in an environment with high humidity (i.e. a room with a humidifier) to prevent condensation inside this unit, which may cause an electrical shock, fire, damage to this unit, and/or personal injury.
- 5 Avoid installing this unit where foreign object may fall onto this unit and/or this unit may be exposed to liquid dripping or splashing. On the top of this unit, do not place:
 - Other components, as they may cause damage and/or discoloration on the surface of this unit.
 - Burning objects (i.e. candles), as they may cause fire, damage to this unit, and/or personal injury.
 - Containers with liquid in them, as they may fall and liquid may cause electrical shock to the user and/or damage to this unit.
- 6 Do not cover this unit with a newspaper, tablecloth, curtain, etc. in order not to obstruct heat radiation. If the temperature inside this unit rises, it may cause fire, damage to this unit, and/or personal injury.
- 7 Do not plug in this unit to a wall outlet until all connections are complete.
- 8 Do not operate this unit upside-down. It may overheat, possibly causing damage.
- 9 Do not use force on switches, knobs and/or cords.
- 10 When disconnecting the power cable from the wall outlet, grasp the plug; do not pull the cable.
- 11 Do not clean this unit with chemical solvents; this might damage the finish. Use a clean, dry cloth.
- 12 Only voltage specified on this unit must be used. Using this unit with a higher voltage than specified is dangerous and may cause fire, damage to this unit, and/or personal injury. Yamaha will not be held responsible for any damage resulting from use of this unit with a voltage other than specified.
- 13 To prevent damage by lightning, keep the power cable and outdoor antennas disconnected from a wall outlet or this unit during a lightning storm.
- 14 Do not attempt to modify or fix this unit. Contact qualified Yamaha service personnel when any service is needed. The cabinet should never be opened for any reasons.
- 15 When not planning to use this unit for long periods of time (i.e. vacation), disconnect the AC power plug from the wall outlet.
- 16 Be sure to read the “TROUBLESHOOTING” section on common operating errors before concluding that this unit is faulty.
- 17 Before moving this unit, press \odot to set this unit to the standby mode, and disconnect the AC power plug from the wall outlet.
- 18 Condensation will form when the surrounding temperature changes suddenly. Disconnect the power cable from the outlet, then leave this unit alone.
- 19 When using this unit for a long time, this unit may become warm. Turn the power off, then leave this unit alone for cooling.
- 20 Install this unit near the AC outlet and where the AC power plug can be reached easily.
- 21 The batteries shall not be exposed to excessive heat such as sunshine, fire or the like.
- 22 Excessive sound pressure from earphones and headphones can cause hearing loss.

This unit is not disconnected from the AC power source as long as it is connected to the wall outlet, even if this unit itself is turned off by \odot . This state is called the standby mode. In this state, this unit is designed to consume a very small quantity of power.

WARNING

TO REDUCE THE RISK OF FIRE OR ELECTRIC SHOCK, DO NOT EXPOSE THIS UNIT TO RAIN OR MOISTURE.

LASER SAFETY

This unit employs a laser. Due to possible eye injury, only a qualified service person should remove the cover or attempt to service this device.

DANGER

This unit emits visible laser radiation when open. Avoid direct eye exposure to beam. When this unit is plugged into the wall outlet, do not place your eyes close to the opening of the disc tray and other openings to look into inside.

WARNING

DO NOT TOUCH THIS UNIT WHEN IT IS USED CONTINUOUSLY AT HIGH VOLUME BECAUSE THE BOTTOM OF THIS UNIT MAY BECOME HOT. IT MAY LEAD TO INJURIES SUCH AS BURNS, ETC.

CONTENTS

INTRODUCTION

WHAT YOU CAN DO WITH THIS UNIT	2
SUPPLIED PARTS	2
ABOUT DISCS AND FILES	3
Types of discs/files that can be used with this unit ...	3
Loading a disc	4
Disc precautions	4
Notice for watching 3D video images	4
FRONT PANEL AND BASIC OPERATION	5
REMOTE CONTROL	6
Installing the batteries in the remote control	9
Using the remote control	9

PREPARATIONS

CONNECTION	10
Connecting component system to this unit	10
Other connection	11
Connecting to a TV	12
HDMI connection	12
Video connection	12
NETWORK AND USB CONNECTION	13
Connecting to the NETWORK terminal	13
Connecting to the USB port	13

OPERATIONS

INITIAL WIZARD/EASY SETUP	14
Setting with the Initial Wizard/Easy Setup	14
BASIC OPERATION	15
Basic operation using HOME/MEDIA menu	15
Playing back photo/music/video	16
Using network content	18
Playing videos from YouTube™ (Asia and Central/South America models only)	18
Basic operation without HOME/MEDIA menu	19
Operation for iPod	20
Operation for CDs	20
ADVANCED PLAYBACK OPERATION	21
On Screen menu	21
Status menu	22
Using Bookmark	23
Program play	23
Using search	24
Enjoying BONUSVIEW™ and BD-Live™	24
LISTENING TO FM RADIO STATIONS	26
Tuning to radio stations	26
Presetting radio stations	26
Selecting preset radio stations (Preset tuning)	26
USING USEFUL FUNCTIONS	27
Using option menu on the front panel display	27
Setting the clock/timer and sleep timer	28
Operating this unit by TV remote control (the HDMI control function)	29

SETTINGS

SETUP MENU	31
Operation for SETUP menu	33
General Setting	34
Display Setting	36
Audio Setting	38
About the video output formats	39
SOFTWARE UPGRADE	40
Upgrading the software	40

ADDITIONAL INFORMATION

TROUBLESHOOTING	41
General	41
Radio reception	42
iPod	43
USB	44
Disc playback	44
Remote control	46
Network	46
Messages on the screen	47
Others	47
GLOSSARY	48
SPECIFICATIONS	50

■ About this manual

- This manual describes how to operate this unit using a remote control except when it is not available. Some of these operations are also available using the front panel buttons.
- Notes contain important information about safety and operating instructions. ☞ indicates a tip for your operation.
- “iPod” described in this manual may also refer to “iPhone” or “iPad”.
- This manual is printed prior to production. Design and specifications are subject to change in part as a result of improvements, etc. In case of differences between the manual and the product, the product has priority.

The icons used in this manual

Icons are used to indicate available buttons/functions for a particular format.

BD : BD-Video

DVD : DVD-Video, DVD-VR, DVD+VR

CD : Audio CD

VIDEO : AVCHD, WMV

MUSIC : MP3, WMA, WAV

PHOTO : JPEG

WHAT YOU CAN DO WITH THIS UNIT

Play back a commercially-released Blu-ray Disc™/DVD/CD*1 → p. 21

In addition to a Blu-ray Disc™ (BD disc), this unit also supports playback of a variety of other discs.

Play back BONUSVIEW™, BD-Live™, etc.*1 → p. 24

You can enjoy additional movies on the latest BD discs.

Play back Video, Music, Photo files on a disc/USB memory device/ iPod/iPhone/iPad*1 → p. 15

Files recorded on discs/USB memory devices/iPod/iPhone/iPad can be played back with this unit.

Play back Video, Music, Photo files on a Home Network Server*1,2 → p. 18

PC contents can be played back with TV by connecting this unit to a network server.

Play back YouTube™ contents on the Internet (Asia and Central/South America models only)*2 → p. 18

You can instantly enjoy YouTube™ contents on the Internet with this unit.

Receive FM Radio stations → p. 26

You can enjoy listening to FM radio stations with this unit.

Perform the Initial Wizard/Easy Setup → p. 14

You can easily set for language, resolution, screen aspect ratio with the Initial Wizard/Easy Setup screen.

Operate with the TV remote control → p. 29

Connecting devices with an HDMI cable, you can control devices with a single remote control using the HDMI control function.

Play back high-quality virtual surround sounds by AIR SURROUND XTREME → p. 16

You can enjoy Yamaha's exclusive AIR SURROUND XTREME that reproduces high-quality virtual surround sounds.

*1 For details on playable discs and files, refer to page 3.

*2 Network setting is needed to use this function.

SUPPLIED PARTS

Make sure you have all of the following items.

Remote control



Batteries (x2)
(AAA, R03, UM-4)

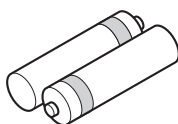

Indoor FM antenna*3

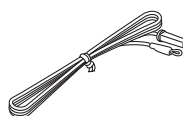

Composite video cable (1.5m)

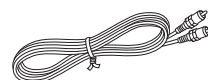







*3 The supplied indoor FM antenna differs depending on your model.









ABOUT DISCS AND FILES

Types of discs/files that can be used with this unit

- 12 cm and 8 cm discs can be played back in this unit. Do not use an 8 cm to 12 cm adapter.
- Use discs that conform to compatible standards as indicated by the presence of official logos on the disc label. Playback of discs not complying with these standards is not guaranteed. In addition, the image quality or sound quality is not guaranteed even if the discs can be played back.

Disc Type	Recording Format	Data Format
BD-ROM/BD-R/ BD-RE	BD-Video	--
DVD-ROM	DVD-Video	--
DVD-R/DVD-R DL/ DVD-RW	DVD-Video/DVD- VR/AVCHD/Data Disc	WMV/MP3/WAV/ WMA/JPEG
DVD+R/DVD+R DL/DVD+RW	DVD-Video/ DVD+VR/AVCHD/ Data Disc	WMV/MP3/WAV/ WMA/JPEG
CD-ROM	CDDA/HDCD	--
CD-R/CD-RW	CDDA/Data Disc	WMV/MP3/WAV/ WMA/JPEG
USB	--	WMV/MP3/WAV/ WMA/JPEG
Network	--	WMV/MP3/WMA/ WAV/JPEG

Region management information		
Destination	BD-Video	DVD-Video
Asia	Region code "A" or "ALL" 	Region number "3" or "ALL" 
Central and South America	Region code "A" or "ALL" 	Region number "4" or "ALL" 
Korea	Region code "A" or "ALL" 	Region number "3" or "ALL" 

Region management information		
Destination	BD-Video	DVD-Video
Europe	Region code "B" or "ALL" 	Region number "2" or "ALL" 
Australia	Region code "B" or "ALL" 	Region number "4" or "ALL" 
Russia	Region code "C" or "ALL" 	Region number "5" or "ALL" 
China	Region code "C" or "ALL" 	Region number "6" or "ALL" 

- BD/DVD video players and discs have region codes, which dictate the regions in which a disc can be played.
- BD/DVD Video operations and functions may be different from the explanations in this manual and some operations may be prohibited due to disc manufacturer's settings.
- If a menu screen or operating instructions are displayed during playback of a disc, follow the operating procedure displayed.

Notes

- Playback for some of the discs in the left side column tables may not be possible depending on the disc.
- Finalize all recording media that is played back in this unit.
- "Finalize" refers to a recorder processing a recorded disc so that it will play in other players/recorders as well as this unit. Only finalized discs will play back in this unit. (This unit does not have a function to finalize discs.)
- Playback of all files on the disc, USB memory device and network is not guaranteed.
- A copyright protected file cannot be played back via a USB memory device and network.

MP3/WMA audio file requirement

- Sampling frequency: within 32 - 48 kHz (MP3/WMA), LPCM 44.1 kHz/16 bit/Stereo (WAV)
- Bitrate: within 8 - 320 kbps (MP3), 32 - 192 kbps (WMA)

WMV file requirement

- WMV9, maximum resolution is 1,920 × 1,080.

Loading a disc

- Insert the disc with the label facing up.
- In case of the disc recorded on both sides, face down the side you want to play back.

Notes

- Playback may begin automatically, depending on the disc and setting of this unit.
- The menu may be displayed first, depending on the disc.
- The disc load time may vary depending on the disc.

Disc precautions

- Do not touch the surface of the disc. Hold a disc by its edge (and the center hole).
- Do not use a pencil or pointed marker to write on the disc.
- Do not put a tape, seal, glue, etc., on a disc.
- Do not use a protective cover to prevent scratches.
- Do not load more than one disc into this unit at one time. This can cause damage to both this unit and the discs.
- Do not insert any foreign objects into the disc slot.
- Do not load a cracked, warped, or glued disc.



- Do not expose a disc to direct sunlight, high temperature, high humidity, or a lot of dust.

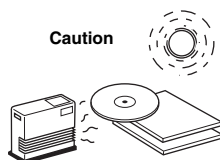

- If a disc becomes dirty, wipe it with a clean, dry cloth from the center out to the edge. Do not use record cleaner or paint thinner.
- To avoid malfunction, do not use a commercially available lens cleaner.

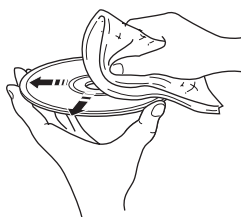

Notice for watching 3D video images

- Some people may experience discomfort (such as eye strain, fatigue, or nausea) while watching 3D video images. We recommend that all viewers take regular breaks while watching 3D video images.
- If you experience any discomfort, stop watching the 3D video images until the discomfort subsides. Consult a doctor if you experience severe discomfort.
- Read the owner's manuals (BD disc and TV) and/or the caution messages that appear on the TV carefully.
- The vision of young children (especially those under six years old) is still under development. Consult your doctor (such as a pediatrician or eye doctor) before allowing young children to watch 3D video images.
- Adults should supervise young children to ensure they follow the recommendations described above.

FRONT PANEL AND BASIC OPERATION

- This unit has an automatic standby function.
- When the source is set to Disc/USB/Network, this unit automatically switches to standby mode if it is left turned on for 1 hour without playback or any other operation being performed.
 - When the source is NOT set to Disc/USB/Network, this unit automatically switches to standby mode if it is left turned on for between 1 to 8 hours without playback or any other operation being performed according to the setting in SETUP menu (p. 34).

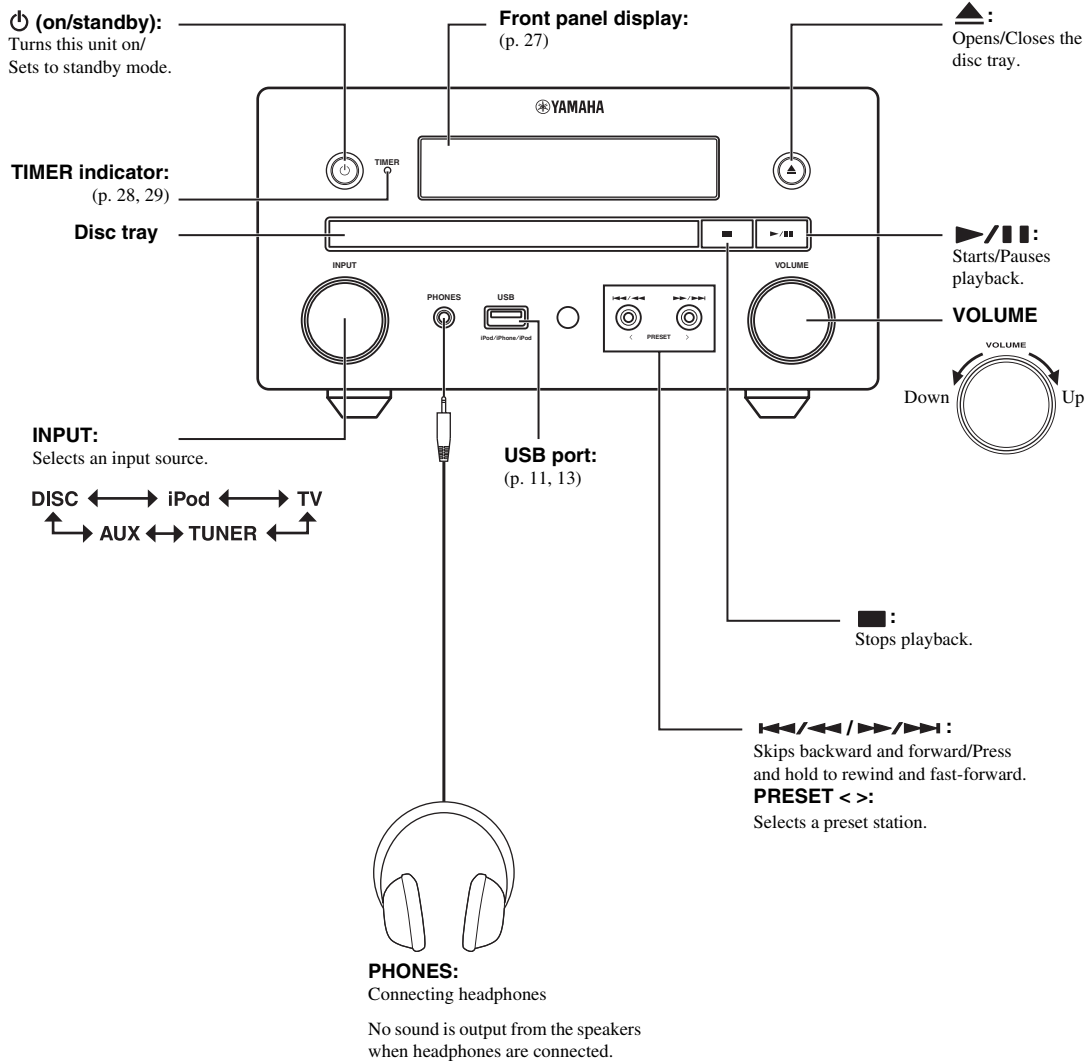





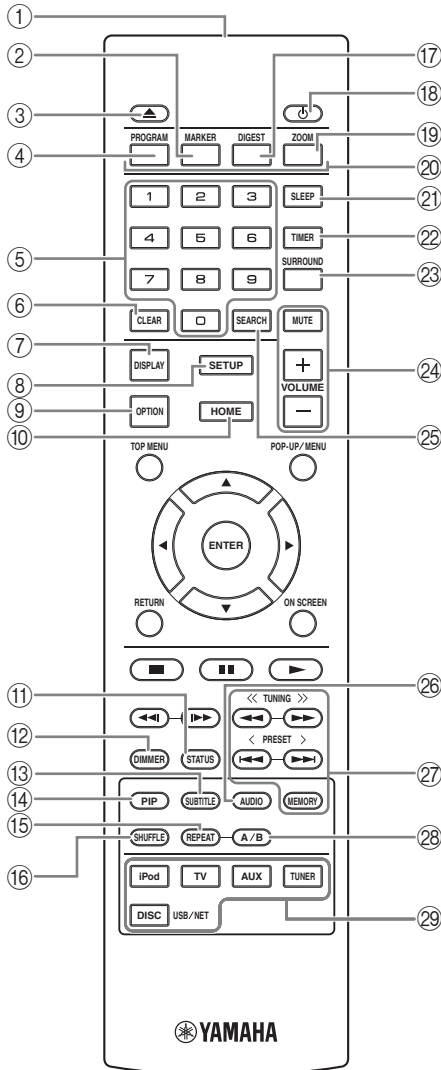

REMOTE CONTROL

Note

⊗ will appear on the top left corner of the screen when the pressed button is not available.



- ① **Infrared signal transmitter** (p. 9)
 - ② **MARKER [DVD VIDEO]**: Sets Bookmark at a specified point of a movie (p. 23). After Bookmark is set, press **DIGEST** to select the set point you want to jump to. You can set up to 12 Bookmarks.
 - ③ **▲**: Opens/Closes the disc tray.
 - ④ **PROGRAM [DVD CD]**: Sets the order of playback (p. 23). You can set up to 15 tracks of an audio disc or titles/chapters of a DVD-Video disc.
 - ⑤ **Numeric buttons**: Enters numbers, or during playback, jumps to the track/chapter corresponding to the number you input. These buttons may not be available depending on the disc type and playback condition.
 - ⑥ **CLEAR**: Clears entered number/set item.
 - ⑦ **DISPLAY**: Switches the information shown on the front panel display (p. 20).
 - ⑧ **SETUP**: Displays SETUP menu screen (p. 31).
 - ⑨ **OPTION**: Enters option menu mode (p. 27).
 - ⑩ **HOME**: Displays HOME menu screen (p. 16).
 - ⑪ **STATUS**: Displays the playback information on the screen (p. 22).
 - ⑫ **DIMMER**: Changes brightness of the front panel display. Choose brightness between bright or dim by pressing this button repeatedly.
 - ⑬ **SUBTITLE [BD DVD VIDEO]**: Changes subtitle languages (p. 49) if available. You can also select this item from On Screen menu (p. 21).
 - ⑭ **PIP [BD]**: Turns on/off the Picture in Picture (p. 24). PIP Mark () is displayed on the screen when this function is available. You can also select this item from On Screen menu (p. 21).
- Note**
- PIP Mark is displayed only when [PIP Mark] is set to [On] (p. 35).
- ⑮ **REPEAT [BD DVD CD VIDEO MUSIC PHOTO]**: Selects repeat mode. Repeat mode shown below will change each time you press the button (p. 20, 22).
 - : Repeats the title being played back.
 - : Repeats the chapter being played back.
 - : Repeats the folder being played back.
 - : Repeats all tracks/files on the disc/folder.
 - : Repeats the track/file being played back.
 - ⑯ **SHUFFLE [DVD CD VIDEO MUSIC PHOTO]**: Selects shuffle play mode (p. 20, 21).
 - ⑰ **DIGEST [PHOTO]**: Shows 12 photo thumbnails. When thumbnails are displayed, you can proceed to the next/previous page with **◀◀ / ▶▶**.
 - [DVD VIDEO]**: Displays Bookmark select bar (p. 23).
 - ⑱ **⏻**: Turns this unit on or sets it to standby mode.

- ⑲ **ZOOM** **DVD** **VIDEO** **PHOTO**: Zooms in/out. The size of the screen will change each time you press the button (zoom in/out: 3 steps each).
- ⑳ **Color buttons** **BD**: Use these buttons according to on-screen instructions.
- ㉑ **SLEEP**: Sets to sleep mode (p. 29).
- ㉒ **TIMER**: Sets to timer mode (p. 28).
- ㉓ **SURROUND**: Turns on/off surround playback mode for the speakers (p. 16). (Does not affect headphone sound.)
- ㉔ **Volume control buttons**: Controls the volume level (p. 16).
Press **MUTE** to turn off the volume. Press again to resume the volume.
- ㉕ **SEARCH** **BD** **DVD** **CD** **VIDEO** **MUSIC**: Jumps to a specified point during playback. For details on this function, refer to “Using search” (p. 24). You can also select this item from Status menu (p. 22).
- ㉖ **AUDIO** **BD** **DVD**: Changes the audio language or format. You can also select from On Screen menu (p. 21).
- ㉗ **FM control buttons**
TUNING **<< / >>**: Starts manual tuning. Press and hold to start automatic tuning (p. 26).
PRESET **< / >**: Selects preset station (p. 26).
MEMORY: Starts preset tuning and stores preset stations (p. 26).
- ㉘ **A/B** **BD** **DVD** **CD** **VIDEO** **MUSIC**: Plays back a specific part you want to repeat.
1 Press **A/B** at the scene where you want to set the start point. [A-] is displayed on the screen.
2 Press **A/B** again at the scene where you want to set the end point. [A-B] is displayed on the screen.
Repeat playback starts.
3 To cancel the repeat playback, press **A/B**. [A-B] disappears and the repeat playback is finished.
- Note**
This function cannot be performed depending on the specifications of the disc.
- ㉙ **Input select buttons**: Selects the input source (p. 15, 19, 26).

Continued to the next page. ➔

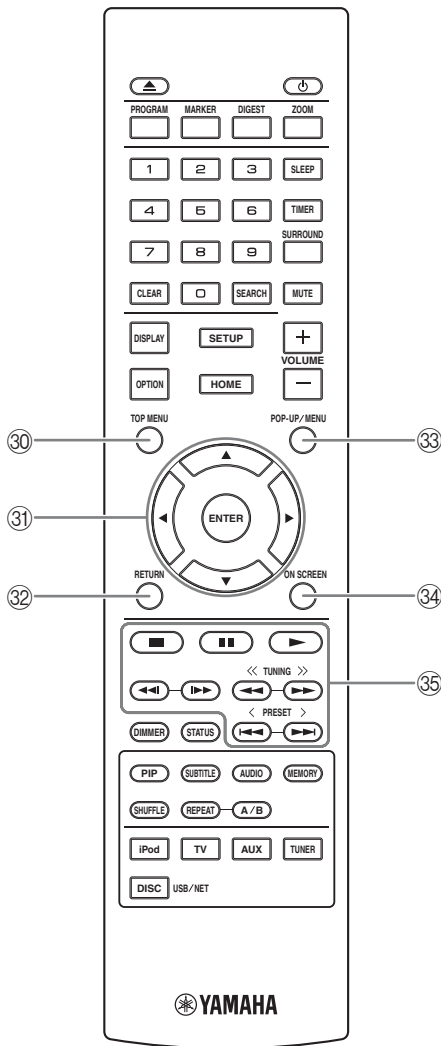

- 30 **TOP MENU** **BD** **DVD** : Displays the top menu screen (p. 49) if the disc contains a menu. Select the desired item using **▲/▼/◀/▶** and **ENTER**.

Note

Specific operations may be different depending on the disc. Follow the instructions of each menu screen.

- 31 **Cursor buttons (▲/▼/◀/▶)**: Moves to select the focused item.
ENTER: Confirms the focused menu/item.
- 32 **RETURN**: Returns to the previous menu or screen, etc.
- 33 **POP-UP/MENU** **BD** **DVD** : Displays pop-up menu. The menu contents displayed vary depending on the disc. For details on how to see and operate the pop-up menu, refer to the manual for the disc. The top menu screen may be displayed by pressing **POP-UP/MENU** depending on the disc.
- 34 **ON SCREEN**: Displays On Screen menu (p. 21).

35 **Control buttons**

BD **DVD** **CD** **VIDEO** **MUSIC** **PHOTO** :

▶ : Plays back contents.

■ : Stops playback. To stop playback completely, press this button twice.

⏸ : Pauses playback.

BD **DVD** **CD** **VIDEO** **MUSIC** :

⏮ / ⏭ : Skips backward/forward.

◀◀ / ▶▶ : Press for instant search/replay. Instant search skips the content 30 seconds. Instant replay replays the content from 10 seconds before.

BD **DVD** **CD** **VIDEO** **MUSIC** :

◀◀ / ▶▶ : Searches backward/forward. The search speed will change each time you press the button (search backward/forward: 5 steps each). Press ▶ to resume normal playback.

PHOTO :

◀◀ / ▶▶ : Changes the speed of a slide show (slower/faster: 3 steps).

Note

Depending on the disc, this unit resumes playback from the point where the unit was previously stopped. To play back from the beginning, press ■ and then press ▶.

Installing the batteries in the remote control

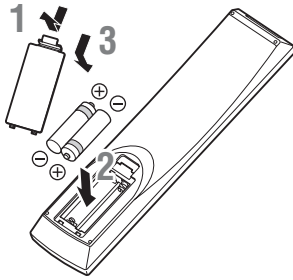

Notes on batteries

- Change both batteries when the operation range of the remote control decreases.
- Use AAA, R03, UM-4 batteries.
- Make sure that the polarities are correct. Refer to the illustration inside the battery compartment.
- Remove the batteries if the remote control is not to be used for an extended period of time.
- Do not use old batteries together with new ones.
- Do not use different types of batteries (such as alkaline and manganese batteries) together. Read the packaging carefully as these different types of batteries may have the same shape and color.
- If the batteries have leaked, dispose of them immediately. Avoid touching the leaked material or letting it come into contact with clothing, etc. Clean the battery compartment thoroughly before installing new batteries.
- Do not throw away batteries with general house waste; dispose of them correctly in accordance with your local regulations.
- Keep batteries away from children. If a battery is accidentally swallowed, contact your doctor immediately.
- When not planning to use the remote control for long periods of time, remove the batteries from the remote control.
- Do not charge or disassemble the supplied batteries.

Using the remote control

The remote control transmits a directional infrared beam. Be sure to aim the remote control directly at the remote control sensor on the front panel of this unit during operation.

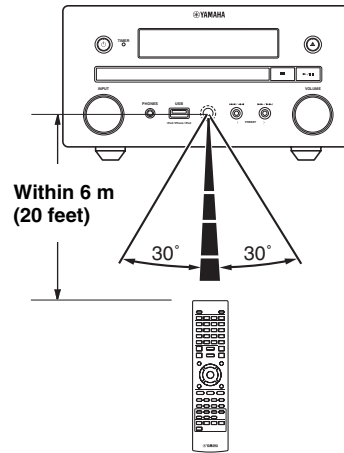

Notes

- The area between the remote control and this unit must be clear of large obstacles.
- Do not spill water or other liquids on this remote control.
- Do not drop the remote control.
- Do not leave or store the remote control in the following types of conditions:
 - high humidity, such as near a bath
 - high temperature, such as near a heater or a stove
 - extremely low temperatures
 - dusty places.
- Do not expose the remote control sensor to strong lighting, in particular, an inverter type fluorescent lamp; otherwise, the remote control may not work properly. If necessary, position the system away from direct lighting.

CONNECTION

Connecting component system to this unit

Make sure you read the following procedure and note carefully before connecting the system.

■ Connecting the system

- 1 Connect the speaker terminals (L) of this unit to the speaker terminals of the left speaker and the speaker terminals (R) of this unit to the speaker terminals of the right speaker using the speaker cables supplied with the speaker set (NS-BP150).
- 2 Connect the supplied FM antenna to the FM jack.

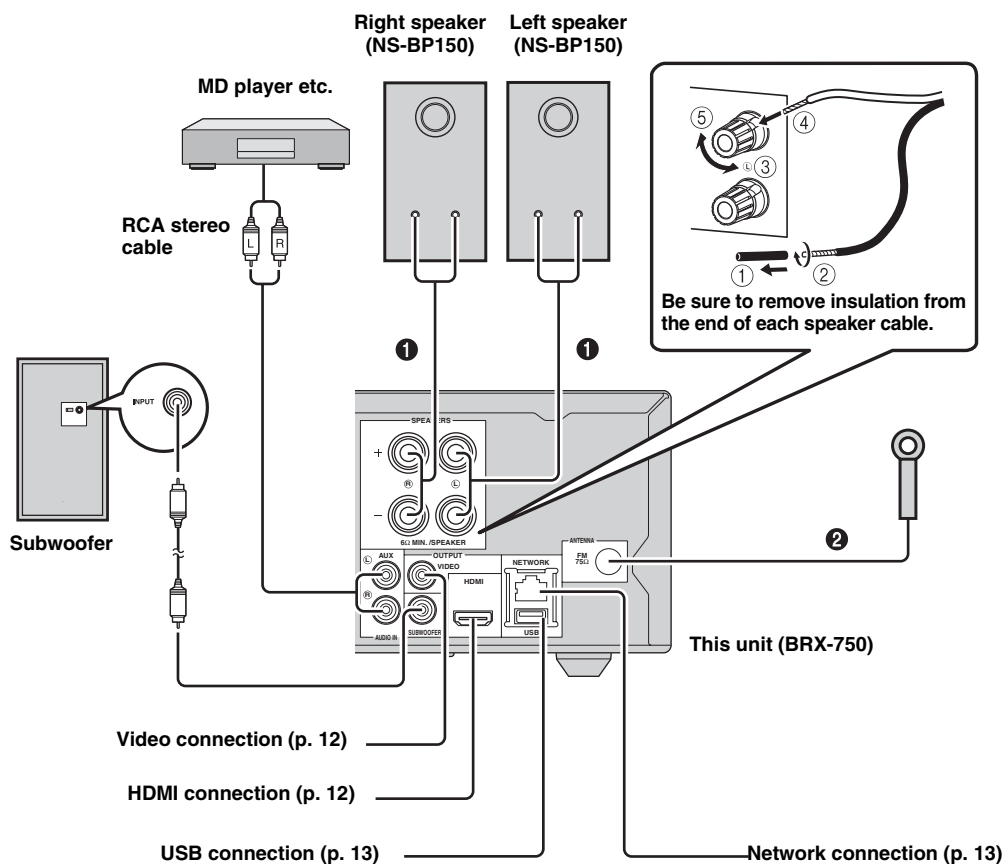

CAUTION

- Do not connect this unit or other components to the main power until all connections between components are complete.
- Do not let the bare speaker wires touch each other or any metal part of this unit. This could damage the unit and/or the speakers.
- All connections must be correct: L (left) to L, R (right) to R, “+” to “+” and “-” to “-”. If the connections are faulty, no sound will be heard from the speakers, and if the polarity of the speaker connections is incorrect, the sound will be unnatural and lack bass. Also, refer to the owner’s manual for each of your components.

Notes

- When connecting speakers other than NS-BP150, use speakers having more than 6Ω impedance.
- If there is a problem of weak radio wave reception in your area or you want to improve radio reception, we recommend that you use commercially available outdoor antennas. For details, consult the nearest authorized Yamaha dealer or service center.

Other connection

■ **Connecting iPod**

You can enjoy music stored in your iPod by connecting it to this unit.

Note

This unit is compatible with iPod classic, iPod nano (2nd, 3rd, 4th, 5th and 6th generation), iPod touch (1st, 2nd, 3rd, and 4th generation), iPhone, iPhone 3G/3GS, iPhone 4, and iPad.

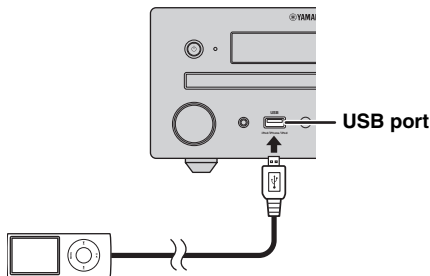

Notes

- Make sure the USB cable is connected securely between your iPod and this unit.
- Connect your iPod to the front USB port of this unit. The rear USB port is not compatible with your iPod.

■ **Connecting the power cable**

After you made all connections, connect the power cables of this unit.

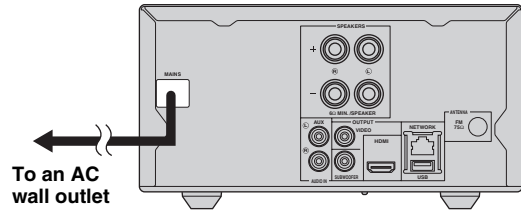

Connecting to a TV

Make sure you refer the following illustration carefully so that connections between this unit and your TV are properly made.

CAUTION

Do not connect the power cable of this unit until all connections are completed.

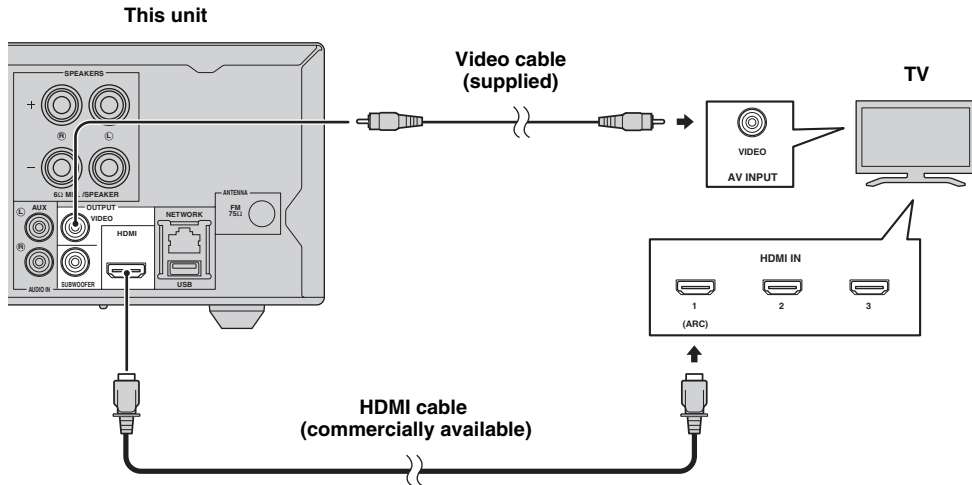

HDMI connection

- You can enjoy high quality digital picture and sound through the HDMI terminals.
- Firmly connect an HDMI cable (commercially available) to the HDMI terminal of this unit.
- Use HIGH SPEED HDMI cables that have the HDMI logo (p. 51).



- When you use the HDMI control function, refer to “Operating this unit by TV remote control (the HDMI control function)” (p. 29) and “[HDMI Control]” (p. 34).
- For information on the output mode of the HDMI terminal, refer to “[HDMI]” (p. 38).
- When no picture is displayed, refer to “TROUBLESHOOTING” (p. 41).

■ Connection for the playback of Blu-ray 3D discs

You need the following equipment and connections to enjoy BD 3D discs on this unit:

- a TV that has 3D functionality.
- a TV and this unit must be connected with HDMI cables.
- a BD disc should contain 3D images.

■ About audio return channel (ARC) supported TV

- You can connect an HDMI cable to the audio return channel supported terminal (the terminal with “ARC” indicated) on the TV.
- You need to activate the HDMI control function of this unit so as to activate audio return channel (ARC) (p. 34).

What is audio return channel (ARC)?

This function allows digital audio signal to be output from a TV to this unit through an HDMI cable, without using a digital audio pin cable.



If your TV is not ARC supported, connect the TV and this unit via the AUX jacks on the unit.

Video connection

- Firmly connect the composite video cable (supplied) to the VIDEO jack.
- Refer to page 39 for information on the video output formats.

Notes

- If you play back the image via VCR, the image may deteriorate due to the copy guard function.
- To enjoy BD 3D discs on this unit, you need to connect a TV and this unit using HDMI cables (commercially available).

NETWORK AND USB CONNECTION

Connecting to the NETWORK terminal

- PC contents can be played back by connecting this unit to the network.
- You can enjoy a variety of contents with interactive functions by connecting to the internet when playing BD-Live compatible discs. Refer to page 24 for information on BD-Live functions.

Notes

- Firmly connect a network cable (commercially available) to the NETWORK terminal.
- Use only an STP (shielded twisted pair) network cable.
- When using the internet, a broadband internet connection as shown below is required.
- Connect the other connector of the network cable to the hub/broadband router.
- When using a broadband internet connection, a contract with an internet service provider is required. For more details, contact your nearest internet service provider.
- Refer to the operation manual of the equipment you have as the connected equipment and connection method may differ depending on your internet environment.
- Use a network cable/router supporting 10BASE-T/100BASE-TX.

Connecting to the USB port

- You can connect a USB memory device (2 GB or greater and formatted with FAT 32/16) for BD Local Storage to the USB port on the rear panel (or front panel) of this unit to save the BD-Live data (p. 25) or to upgrade the software of this unit (p. 40).
- Firmly connect a USB memory device (commercially available) to the USB port.

CAUTION

- Do not remove the USB memory device or unplug the power cable while the operations for BD-Live or software upgrade are being performed.
- Do not use a USB extension cable when connecting a USB memory device to the USB port of this unit. Using a USB extension cable may prevent the unit from performing correctly.

Notes

- Yamaha cannot guarantee that all brands' USB memory devices will operate with this unit.
- For more notes on using USB memory devices, refer to page 15.

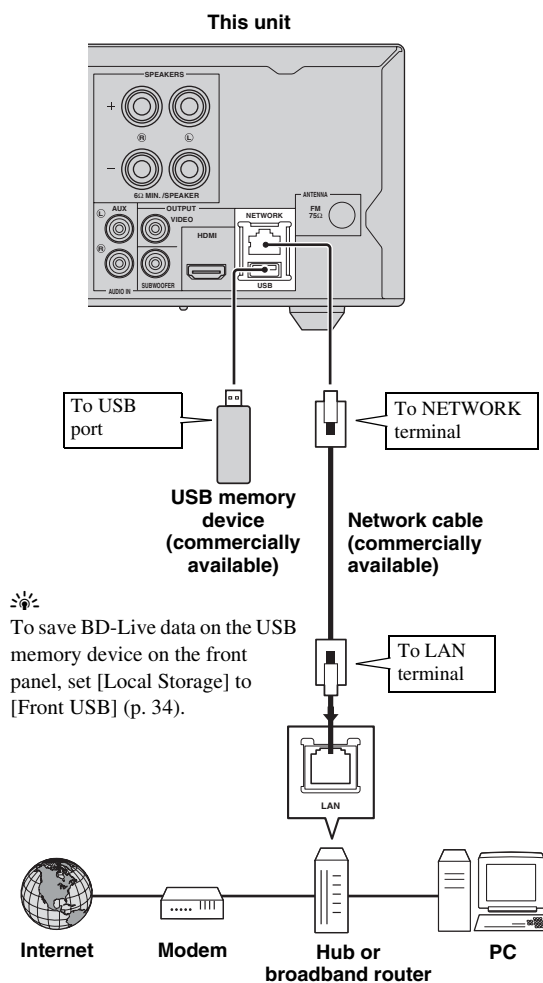

■ After connecting

- When you set the Network setting manually, refer to “Network” (p. 35).
- To play back the PC contents on your network, refer to “Using network content” (p. 18).

INITIAL WIZARD/EASY SETUP

Setting with the Initial Wizard/Easy Setup

Initial Wizard/Easy Setup allows you to set language, resolution, and screen aspect ratio easily. Initial Wizard screen is displayed when you turn this unit on for the first time after purchase or upgrade. Same setting can be performed from SETUP menu → [System] → [Easy Setup] (p. 31).

- 1 When Easy Setup screen is displayed, press **ENTER** to start Easy Setup.

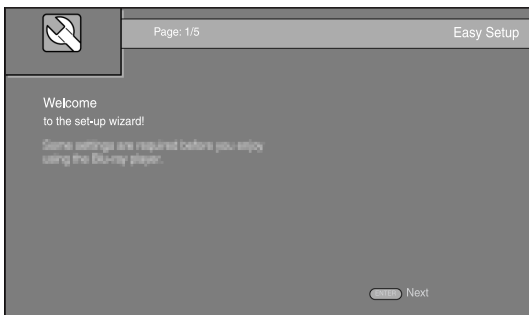

- 2 Press **▲/▼** to select the language you want to display on the screen, then press **ENTER**.

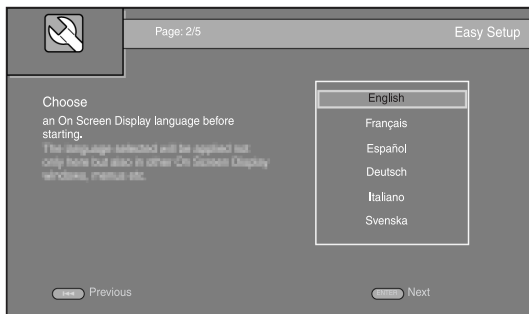

- 3 Press **▲/▼** to select the resolution, then press **ENTER**. For details on setting items, refer to “[Video Out Select]” (p. 36).

Note

When you connect your TV and this unit via the VIDEO jack, select [Composite].

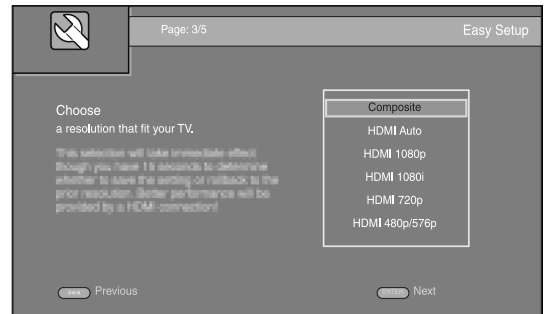

- 4 Press **▲/▼** to select the screen aspect ratio, then press **ENTER**. For details on setting items, refer to “[TV Screen]” (p. 36). Easy Setup is completed.

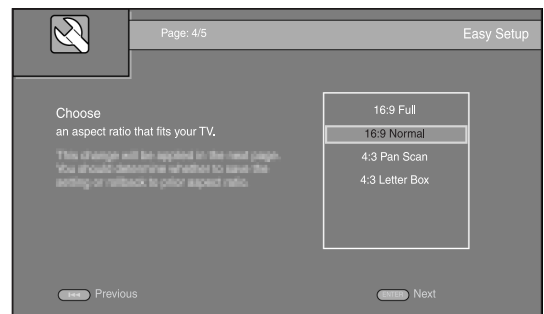

- 5 Press **ENTER** to exit Easy Setup.

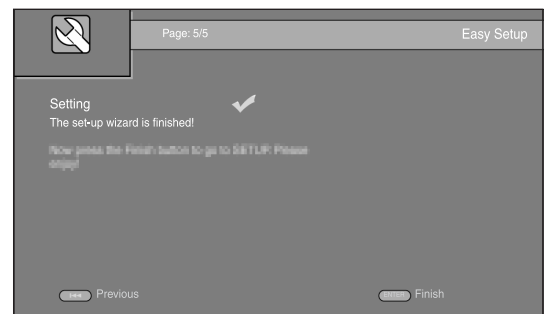

Notes

- When no picture is displayed after Initial Wizard/Easy Setup is completed, refer to “TROUBLESHOOTING” (p. 41).
- A warning message concerning 3D video playback appears when this unit is turned on. Press **ENTER** to dismiss the message or **CLEAR** to disable it (p. 34).







BASIC OPERATION

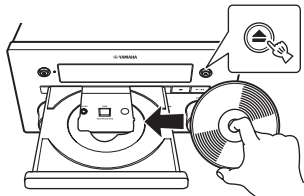

When the source is a CD/iPod/FM/TV, refer to “Basic operation without HOME/MEDIA menu” (p. 19). When the source is a BD/DVD/USB/Network, read the following (a CD can also be played back with HOME/MEDIA menu).

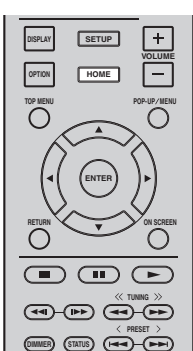
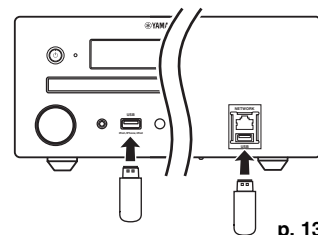
Basic operation using HOME/MEDIA menu

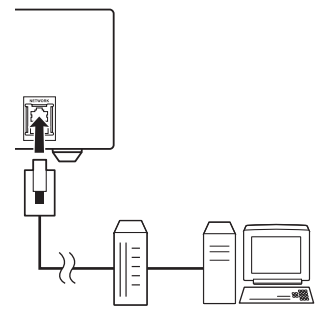
Follow the procedures below to play back the source.

	1 Set the source	2 Switch the input	3 Refer to the following pages for more operations
Disc	 <p>p. 16</p>		
USB*1	<p>Front Rear</p>  <p>p. 13, 16</p>		
Network (PC contents and YouTube*2)	 <p>p. 13, 18</p>		

- *1 • Some devices may not work properly even if they meet the requirements.
- Playability of and power supply to all kind of USB devices are not guaranteed.
- The reading time may exceed 30 seconds depending on the number of files/folders.
- Yamaha and suppliers accept no liability for the loss of data saved on the USB devices connected to this unit.
- As a precaution, it is recommended that the files are made backup copies.
- *2 Available for Asia and Central/South America models only.

Controlling the volume level

- 1 Press the **Volume control buttons** (+/-) on the remote control to increase/decrease the volume level (p. 7).

Turning on/off surround playback mode

- 1 Press **SURROUND** to turn on/off surround playback mode (p. 7).

When it is set to on:

- plays back surround sounds using Yamaha's exclusive AIR SURROUND XTREME (p. 48) if the sources is a surround playback source such as a BD.
- reproduces wider stereo sounds if the source is a stereo playback source such as an audio CD.

Playing back photo/music/video

HOME and MEDIA menus allow you to browse and play multi-media files on data discs, USB memory devices and your network.

Note

For details on playable discs and files, refer to page 3.

Basic operation

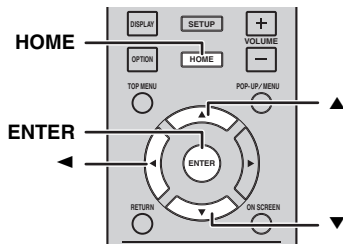

- ▲/▼: Moves the focus.
- ◀: Returns to the parent folder.
- HOME**: Moves to/exits HOME menu screen.
- ENTER**: Confirms the folder/file.

Icons on the top of MEDIA menu

- : Plays back the disc on the tray, or displays contents in the data disc.
- : Displays contents in the USB memory device connected to the USB port.
- : Searches for a DLNA (p. 18) server on the network.
- : Displays contents on the connected DLNA server.

Common operations for playing back files in a selected folder

Example: Selecting a movie file on a USB memory device

Note

Stop the playback of the video before you move to MEDIA menu screen.

- 1 Press **HOME** to move to HOME menu screen.

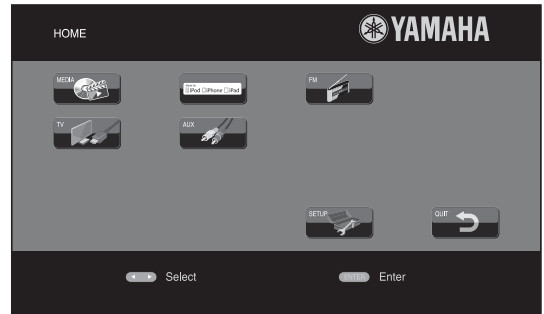

HOME menu screen may differ depending on the model.

- 2 Press ◀/▶/▲ to select [MEDIA], then press **ENTER**.
MEDIA screen appears.

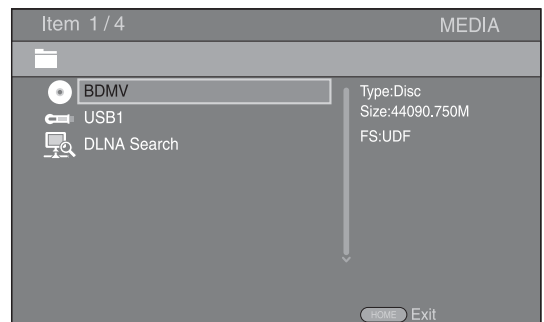

- 3 Select the item which contains the file you want to play back, then press **ENTER**.

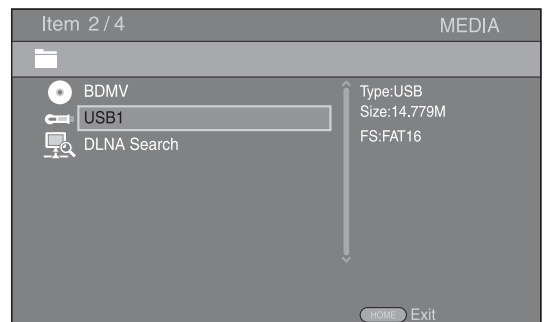

- 4 Select the Photo, Music, Video or AVCHD folder you want to play back, then press **ENTER**.
To return to the parent folder, press **◀** or select **⏪**.

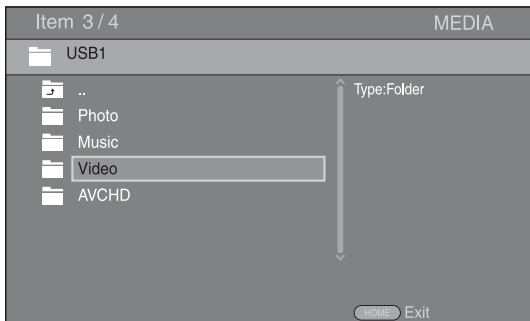

Note

Note that the only file type selected on this step will be displayed in the following step. For example, if you selected the Photo folder in this step, only photo files are displayed after this step. When you want to play back other than photo, return to this step and select file type again.

- 5 Select the folder(s) containing the file you want to play back.

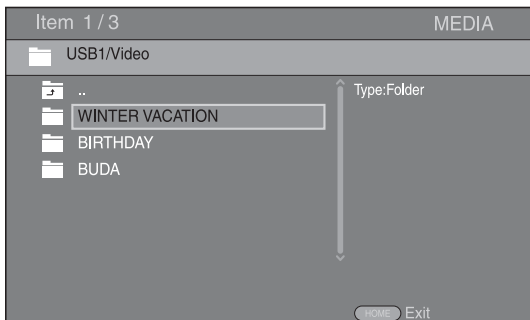

- 6 Select the file you want to play back, then press **ENTER**.

When a video file is selected, playback starts.

When a music file is selected, Status menu is displayed and playback starts.

When a photo file is selected, slide show starts.

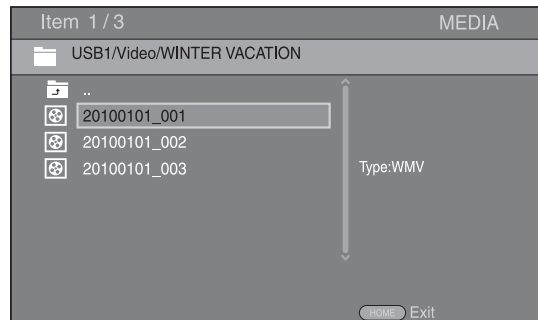

To enjoy a slide show with music, press **HOME** to return to HOME menu screen while music is played back, and select the photo file.

Note

The displayed file may not be played back depending on the content.

Operations for viewing photos

While viewing photos, the buttons on the remote control work as shown below.

- : Stops a slide show and returns to the file browser.
- ■ : Pauses a slide show.
- ▶ : Plays a slide show.
- ▶▶ : Moves to a next photo.
- ◀◀ : Moves to a previous photo.
- ▶▶▶ : Makes a slide show faster in 3 steps.
- ◀◀◀ : Makes a slide show slower in 3 steps.
- ▲ : Inverts a photo.
- ▼ : Reflects a photo.
- ◀ : Rotates a photo counterclockwise.
- ▶ : Rotates a photo clockwise.

ZOOM: Zooms in/out a photo (zoom in/out: 3 steps each).

▲/▼/◀/▶ : Pans in zoom mode when a photo is larger than the screen.

DIGEST: Switches to thumbnail mode (p. 6). When thumbnails are displayed, you can proceed to the next/previous page with ◀◀◀/▶▶▶.

Using network content

About DLNA

This unit is a DLNA certified digital media player. You can manage photo, music and video contents stored on DLNA servers on your home network. DLNA (Digital Living Network Alliance) provides easy sharing of digital media through network in the home, and you can enjoy digital contents stored on your DLNA-server-software-installed PC or other DLNA compatible device with your TV via this unit. To connect this unit to your DLNA servers, some settings for the DLNA server or device are required. For details, refer to your DLNA server software or DLNA device.

Playing back shared contents

Note

To play back files on your PC, install a DLNA server software, such as Windows Media Player 12, and share files you want to play back.

- 1 Turn on the PC with DLNA server software installed or the DLNA device connected to your home network.
- 2 Press **HOME** to display HOME menu screen, then select [MEDIA] to move to MEDIA menu. The DLNA servers connected to the network are listed on the screen.

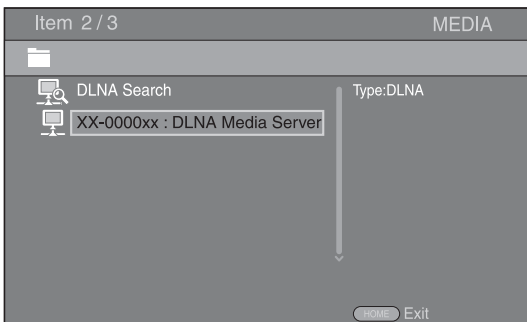

Notes

- If your DLNA server is not listed, select [DLNA Search] to find it.
- Depending on the DLNA server, this unit may need to be permitted from the server.
- To play the file on the DLNA server, this unit and the server must be connected to the same access point.
- The file requirements may not always be compatible. There may be some restrictions depending on file features and DLNA sever capability.

- 3 Select the file you want to play back.

Notes

- The playback and operating quality may be affected by your home network condition.
- The files from removable media, such as USB memory devices or DVD-drive on your media server, may not be shared properly.

Playing videos from YouTube™ (Asia and Central/South America models only)

You can watch movies from YouTube over the internet using this unit.

The services may be changed without notice.

- 1 Press **HOME** to display HOME menu screen.

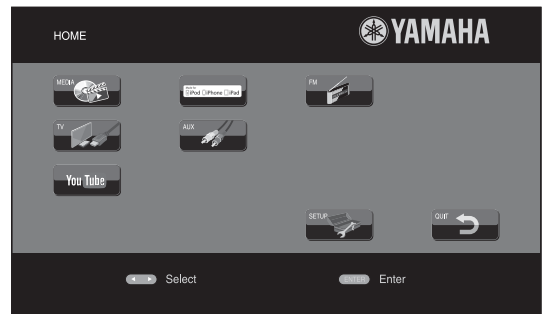

HOME menu screen may differ depending on the model.

- 2 Press **▲/▼/◀/▶** to select [YouTube], then press **ENTER**.









To return to HOME menu screen, press **RETURN**.

Notices for network services

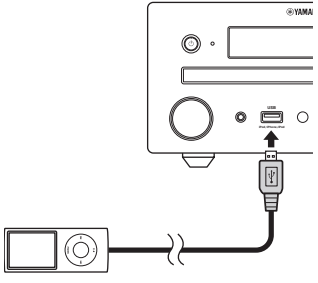
- Access to content provided by third parties requires a high speed internet connection and may also require account registration and a paid subscription.
- Third party content services may be changed, suspended, interrupted, or discontinued at any time without notice, and Yamaha disclaims any liability in connection with such occurrences.
- Some content may only be available for specific countries and may be presented in specific languages.
- Yamaha does not represent or warrant that content services will continue to be provided or available for a particular period of time, and any such warranty, express or implied, is disclaimed.

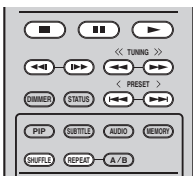
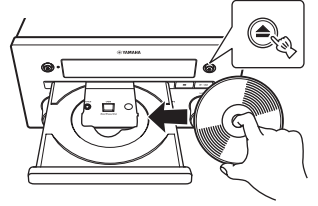
Basic operation without HOME/MEDIA menu

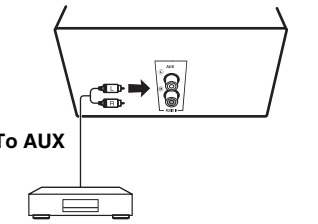
Follow the procedures below to play back the source.

	1 Set the source	2 Switch the input	3 Select music and start playback
iPod*1	 <p>p. 11, 20</p>		
CD	 <p>p. 20</p>		
AUX			<p>For details on operation, refer to the instruction manual supplied with the device connected such as a MD player, etc.</p>
FM	To receive FM radio stations, refer to page 26.		
TV	To output TV sounds, refer to page 12 for connection and select the input source to TV (p. 7).		

*1 • Some features may not be available depending on the model or the software version of your iPod.

• When you play back your iPod, Music Enhancer feature is enabled to enhance the sound for compressed music by regenerating musical elements that are lost through compression. (Available only for iPod.)

■ Controlling the volume level

- 1 Press the **Volume control buttons** (+/-) on the remote control to increase/decrease the volume level (p. 7).

■ Turning on/off surround playback mode

- 1 Press **SURROUND** to turn on/off surround playback mode (p. 7).

When it is set to on:

- plays back surround sounds using Yamaha's exclusive AIR SURROUND XTREME (p. 48) if the source is a surround playback source such as a BD.
- reproduces wider stereo sounds if the source is a stereo playback source such as an audio CD.

Operation for iPod

You can operate playback of your iPod by using the buttons on the remote control.

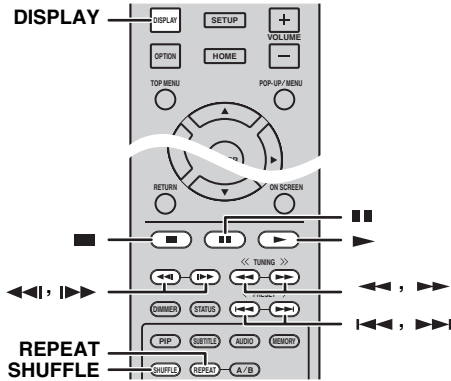

Note

Some features may not be compatible depending on the model or the software version of your iPod.

■ Playback controls

1 Press any buttons below during playback.

- : Stops playback.
 - ■ : Pauses playback.
 - ▶▶▶ : Skips forward.
 - ◀◀◀ : Skips backward.
- To start/resume playback, press ▶ .



Press **DISPLAY** to display information below on the front panel display during playback.

- Song name
- Artist name
- Album name

Note

There are some characters that cannot be displayed on the front panel display of this unit.

■ Shuffle play

You can play back in random sequence.

1 Press **SHUFFLE** repeatedly for shuffle play. Each press cycles as follows:



*1 You cannot set ALBUMS when you use an iPod touch, iPhone, and iPad.

■ Repeat play

You can repeat playback as you want.

1 Press **REPEAT** repeatedly for repeat play. Each press cycles as follows:



Operation for CDs

You can also operate playback of music for CDs.

■ Playback controls

1 Press any buttons below during playback.

- : Stops playback.
 - ■ : Pauses playback.
 - ▶▶▶ : Skips forward.
 - ◀◀◀ : Skips backward.
 - ▶▶ : Searches forward.
 - ◀◀ : Searches backward.
 - ▶▶▶▶ : Press for instant search. Instant search skips the music 30 seconds.
 - ◀◀◀◀ : Press for instant replay. Instant replay replays the music from 10 seconds before.
- To start/resume playback, press ▶ .



You can also use the **Numeric buttons** to enter the number of the song directly. To clear the entry, press **CLEAR**.

■ Shuffle play

You can play back in random sequence.

1 Press **SHUFFLE** repeatedly for shuffle play. Each press toggles as follows:



■ Repeat play

You can repeat playback as you want.

1 Press **REPEAT** repeatedly for repeat play. Each press cycles as follows:



ADVANCED PLAYBACK OPERATION

This chapter explains playback of commercially available BD/DVD/CD discs, and recorded DVD-RW/R discs.

Note

For the basic playback operation, refer to page 6.

On Screen menu

To display On Screen menu, press **ON SCREEN**. After that, press **▲/▼/◀/▶** to select an item, then press **ENTER** to operate the desired function.

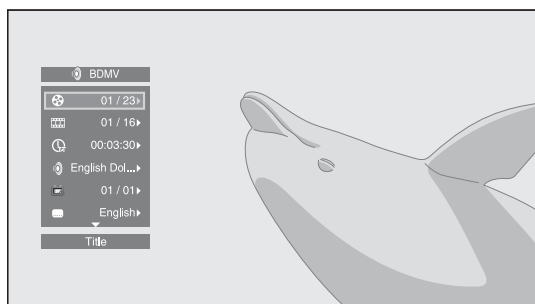

On Screen menu contains following items.

Title **BD** **DVD** **VIDEO** : Shows the title number being played back. You can skip to the desired title by selecting it from this item.

Chapter **BD** **DVD** **VIDEO** : Shows the chapter number being played back. You can skip to the desired chapter by selecting it from this item.

Track/File **CD** **VIDEO** **MUSIC** **PHOTO** : Shows track/file number being played back. You can skip to the desired track/file by selecting it from this item.

Time **BD** **DVD** **CD** **VIDEO** **MUSIC** : Shows the playback time. Select display type from the following:

- Elapsed playback time of the title, chapter, disc, track or file.
- Remaining playback time of the title, chapter, disc, track or file.

Mode/Play Mode

DVD **CD** **VIDEO** **MUSIC** **PHOTO** : Shows current playback mode. You can select playback mode from the following:

- CD**
 - Normal: Normal playback.
 - Shuffle: Random playback without repetition.
 - Random: Random playback with repetition.

DVD

- Normal
- Shuffle CH (chapter)
- Shuffle TT (title)
- Shuffle All
- Random CH (chapter)
- Random TT (title)
- Random All



VIDEO MUSIC PHOTO

- Normal
- Shuffle F (folder)
- Random F (folder)

Audio **BD** **DVD** **VIDEO** : Shows audio language/signal of a BD/DVD disc currently selected. You can select the desired type of audio.

Angle **BD** **DVD** : Shows the currently-selected angle number. If the video is recorded with multiple angles, you can change the angle.



When the Angle Mark () is set to [On] (p. 35),  is displayed on the screen when this function is available.

Subtitle **BD** **DVD** **VIDEO** : Shows the currently-selected subtitle language when the subtitle is provided.

Subtitle Style **BD** : Shows the currently-selected subtitle style. This function is available only for Video-file external subtitle. You can select the desired text style of subtitle.

Bitrate **BD** **DVD** **CD** **VIDEO** **MUSIC** : Shows bitrate of the audio/video signal.

Second Video **BD** : Turns the PIP on/off (p. 6).

Second Audio **BD** : Turns the secondary audio on/off.

Ins Search

BD **DVD** **CD** **VIDEO** **MUSIC** : Skips 30 seconds.

Ins Replay

BD **DVD** **CD** **VIDEO** **MUSIC** : Replays the content from 10 seconds before.

Slide Show

PHOTO :

Shows slide show speed. You can select the slide show speed from Slow/Medium/Fast.

Transition **PHOTO** : Shows how photo appears on the screen. You can select the transition type.

Status menu

This shows various settings, such as subtitles, angle settings and the title/chapter/track number currently played back. To display Status menu, press **STATUS**. Status menu contains following menus.

BD DVD VIDEO

Example: Icons when playing a BD disc

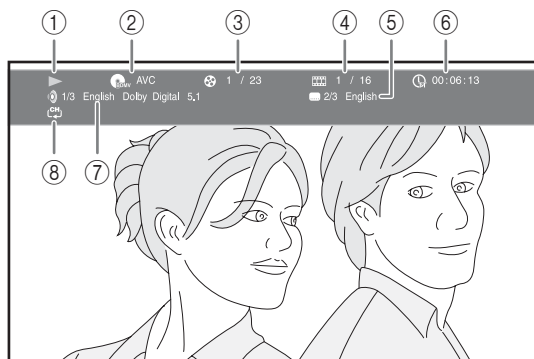

- ① **(Playback status)**
- ② **(Disc type/video file icon)**
- ③ **(Title number being played):** You can jump to specified title with **SEARCH** button (p. 7).
- ④ **(Chapter number being played):** You can jump to specified chapter with **SEARCH** button (p. 7).
- ⑤ **(Subtitle currently selected):** You can change the subtitle language with **SUBTITLE** button (p. 6).
- ⑥ **(Elapsed playback time):** You can jump to specified point with **SEARCH** button (p. 7).
- ⑦ **(Audio currently selected):** You can change the audio language or format with **AUDIO** button (p. 7).
- ⑧ **(Repeat mode):** Shows current repeat mode (p. 6).

CD MUSIC

Example: Icons when playing a music file

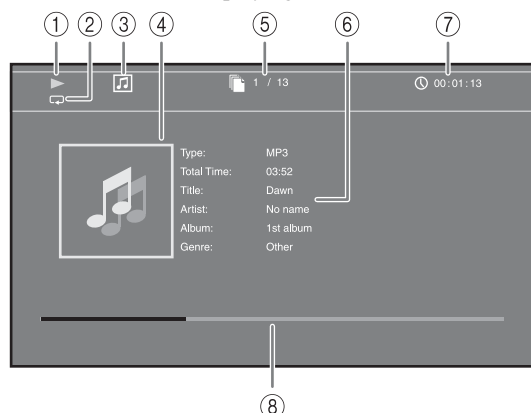

- ① **(Playback status)**
- ② **(Repeat mode):** Shows current repeat mode (p. 6).
- ③ **(Disc type/music file icon)**
- ④ **(Artwork) MUSIC:** Displays artwork if the file contains it.
- ⑤ **(Track/file number being played):** You can jump to specified track with **SEARCH** button (p. 7).
- ⑥ **(Information) MUSIC:** Displays music information if the file contains them.
- ⑦ **(Elapsed playback time):** You can jump to specified point with **SEARCH** button (p. 7).
- ⑧ **(Progress bar) MUSIC:** Shows progress status of current song.

PHOTO

Example: Icons when viewing a photo file



- ① **(Playback status)**
- ② **(Photo file icon)**
- ③ **(File number being displayed)**
- ④ **(Repeat mode):** Shows current repeat mode (p. 6).
- ⑤ **(Slide show speed)**

Using Bookmark

This allows you to set Bookmark at the specified point of the video. After Bookmark is set, you can move to the point you set using this function. You can set up to 12 Bookmarks.

DVD VIDEO

Example: Setting Bookmark when playing back a movie.

- 1 Press **MARKER** during playing back the movie to set Bookmark. Bookmark number and the status are displayed.

Bookmark: 1/12 Title: 1 Chapter: 1 Time: 00:01:26

- 2 After Bookmark is set, press **DIGEST** to display Bookmark select bar.

Title:01 Chapter:01 Time:00:01:26 **Bookmark**
 01 02 03 04 05 06 07 08 09 10 11 12 **Clear**

- 3 Press **◀▶** to select the Bookmark you want to play back, then press **ENTER**.
 Press **CLEAR** to delete the selected Bookmark.

Note

When playback is finished (e.g., ejecting the disc, pressing **■** twice), Bookmarks are automatically deleted.

Program play

This allows you to program playback order of audio disc tracks or DVD chapters. You can program up to 15 tracks/chapters.

DVD CD

Example: Programming the playback order of CD tracks

- 1 Press **PROGRAM** during playback to display PROGRAM screen.

PROGRAM
 CD Track Total: 13
 1 --- 6 --- 11 ---
 2 --- 7 --- 12 ---
 3 --- 8 --- 13 ---
 4 --- 9 --- 14 ---
 5 --- 10 --- 15 ---
Play **Clear** **Clear** **Return** **Stop**

- 2 Press **ENTER** to program playback order.
 For audio disc, press **▲/▼** to select a desired track, then press **ENTER**.
 For DVD-Video discs, select a desired title (shown as TT) and chapter (shown as CH) instead of a track.
 To clear a set track, select the track you want to clear, then press **CLEAR**.
 Press **RETURN** to cancel the Program play.

PROGRAM
 CD Track Total: 13
 1 Track: 12 6 --- 11 ---
 2 Track: 05 7 --- 12 ---
 3 Track: 00 8 --- 13 ---
 4 --- 9 --- 14 ---
 5 --- 10 --- 15 ---
Play **Clear** **Clear** **Return** **Stop**

- 3 After programming is finished, press **▶** to set and start program playback.
- 4 To cancel program play, stop playback completely by pressing **■** twice.

Using search

This allows you to jump to the specified point during playback.





BD DVD CD VIDEO MUSIC

Example: Searching to the specified point



1 Press **SEARCH** during playback. Status bar appears.

2 Press **▲/▼/◀/▶** to select one of the item below, then press **ENTER**.



BD DVD :

- Title number (shown as )
- Chapter number (shown as )
- Elapsed title time (shown as )
- Elapsed chapter time (shown as )

CD :

- Track number (shown as )
- Elapsed track time (shown as )
- Elapsed disc time (shown as )

VIDEO MUSIC :

- File number (shown as )
- Elapsed file time (shown as )

3 Press **▲/▼** or number buttons to set/adjust the value of the focused item, and press **ENTER** to jump to the specified point.

4 To close the status bar, press **STATUS**.

Enjoying BONUSVIEW™ and BD-Live™

This unit supports BONUSVIEW (p. 48) (BD-ROM Profile 1 Version 1.1) and BD-Live (p. 48) (BD-ROM Profile 2) playback functions.



Note

Functions and playback method vary depending on the disc. Refer to the guidance on the disc or the supplied user's manual.

■ Using Picture in Picture function (secondary audio/video playback)

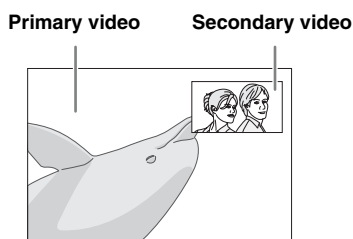
BD-Video that includes secondary audio and video compatible with Picture in Picture can be played back with secondary audio and video simultaneously as a small video in the corner.



1 While PIP Mark () or Secondary Audio Mark () is displayed, press **PIP** to turn the Picture in Picture function on/off.

Notes

- To listen to secondary audio from a TV connected with an HDMI cable, make sure that the Audio Output setting (HDMI) is set to [PCM] (p. 38).
- Depending on the disc, to listen to secondary audio, you may need to set secondary audio to on from the top menu of the disc (p. 8).
- The secondary audio and video for Picture in Picture may automatically play back and be removed depending on the content. Also, playable areas may be restricted.

■ Using the feature of BD-Live™

- 1 Set the Network setting (p. 35).

- 2 Connect the USB memory device to this unit (p. 13).
 - BD-Live data is saved in a USB memory device connected to this unit.
 - Connect a USB memory device (2 GB or greater and formatted with FAT 32/16) supporting USB 2.0 High Speed (480 Mbit/s) to the USB port that you select on Local Storage (p. 34). The default setting is the USB port on the rear panel.
 - A “BUDA” folder is created automatically in the USB memory device when necessary.
 - If there is insufficient storage space, the data will not be copied/downloaded. Delete unneeded data or use a new USB memory device.
 - Some time may be required for the data to load (read/write).

- 3 Play back the disc.

- 4 Run BD-Live according to the instructions on the disc.

Notes

- Regarding playback method of BD-Live contents, etc., perform the operations in accordance with the instructions in the BD disc manual.
- To enjoy BD-Live functions, perform the network connection (p. 13) and Network settings (p. 35).
- Refer to “[BD-Live Connection]” (p. 35) regarding the setup to restrict access to BD-Live contents.
- The time required to download the provided programs into the USB memory device connected to this unit varies depending on the internet connection speeds and the data volume of the programs.
- BD-Live programs provided through the internet may not be able to display the connection depending on the status (upgrading) of the provider. In such cases, take out the disc and try again.
- If the BD-Live screen does not appear for a while after you select the BD-Live function in the BD disc menu, the USB memory device may not have enough free space. In such cases, eject the disc from this unit, and then erase the data in the USB memory device selecting [Format] in [Local Storage] (p. 34).

LISTENING TO FM RADIO STATIONS

Tuning to radio stations

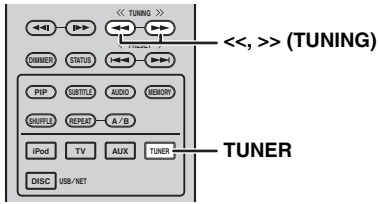

- 1 Press **TUNER**.
- 2 Press and hold **<</> (TUNING)**.
Automatic tuning starts.

☀️
If the signal received from the station you want to select is weak, you can also tune into radio stations manually by pressing **<</> (TUNING)** repeatedly. In this case, the sound will be monaural.

Presetting radio stations

You can store your favorite FM stations with the preset function.

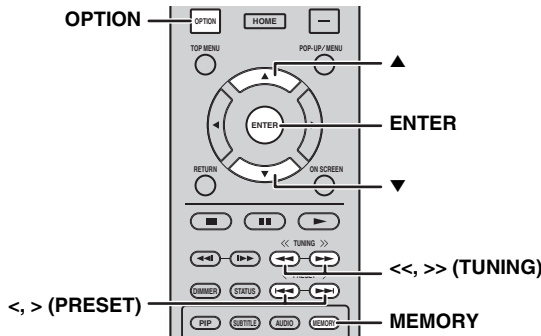

Automatic preset tuning

- 1 Press and hold **MEMORY** for more than 3 seconds in FM mode.
- 2 Press **ENTER**.
Start the automatic preset.

Note

When you perform the automatic preset, all stored stations are cleared and the new stations are stored.

Manual preset tuning

- 1 Select a favorite radio station by pressing **<</> (TUNING)**.
- 2 Press **MEMORY**.
- 3 Select the preset number you want to store to by pressing **▲/▼** or **</> (PRESET)**.
- 4 Press **ENTER**.
The manual preset is complete.

- ☀️
- You can preset up to 30 FM stations.
 - To cancel the manual preset while choosing a preset number, press **MEMORY** again.
 - You can delete a preset station by pressing **OPTION** → **▲/▼** → **ENTER** to select [PRESET DEL] (p. 27).

Selecting preset radio stations (Preset tuning)

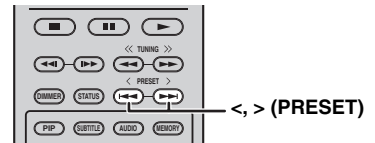

- 1 Select the preset radio station in FM mode by pressing **</> (PRESET)**.

☀️
You can also use the **Numeric buttons** on the remote control or **</> (PRESET)** on the front panel of this unit to select the preset radio station.

USING USEFUL FUNCTIONS

Using option menu on the front panel display

The option menu appears on the front panel display by pressing **OPTION**. You can set various useful functions with option menu.

Option menu	Parameter or control range	Reference page
PRESET DEL	(Displays only when the input source is set to FM.)	26
TREBLE	-10 dB to +10 dB	below
BASS	-10 dB to +10 dB	below
BALANCE	L+5 - CENTER - R+5	below
BASS BOOST	ON/OFF	below

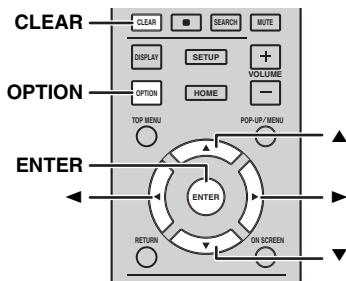

■ Setting tone/balance

[TREBLE]*2: Adjusts the high frequency response.

[BASS]*2: Adjusts the low frequency response.

[BALANCE]: Adjusts the volume level of each left and right speaker channel.

[BASS BOOST]: Boosts the low frequency response when set to [ON].

*2 Also effective when you are using headphones.

- 1 Press **OPTION**.
- 2 Select desired option menu by pressing **▲/▼**.
- 3 Press **ENTER** to confirm.
- 4 Change the settings by pressing **▲(▶)/▼(◀)**.
- 5 Press **ENTER** to complete the setting. *1
- 6 Press **OPTION** to exit option menu.

*1 To set additional items, repeat steps 2 to 5.

Setting the clock/timer and sleep timer

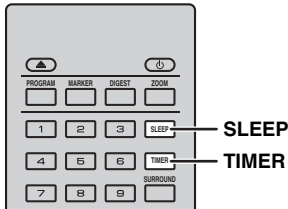

■ Setting the clock

You can set the clock by using the remote control directly. The clock appears on the front panel display.

- 1 Press **TIMER**.
- 2 Press **ENTER**.
- 3 Set hour and minute by pressing **▲/▼**. Press **◀/▶** to switch the hour or minute setting.
- 4 Press **ENTER** to complete the setting.



When setting the clock, you can also use the **Numeric buttons** to enter the hour and minute. To confirm the entry, press **ENTER**. To clear the entry, press **CLEAR**.

Note

The time setting will be lost if you disconnect the power cable from the wall outlet.

■ Setting the timer

The timer sets this unit to play back the source at the time you set.

- 1 Press **TIMER**.
- 2 Select desired setting items (OnTime/Period/Source/Volume) by pressing **▲/▼**.
- 3 Press **ENTER** to confirm the item.

- 4 Change the settings by pressing **▲/▼** or **Numeric buttons**.
- 5 Press **ENTER** to confirm the setting.
- 6 Repeat steps 2 through 5 to set each setting item.



- To clear the entry, press **CLEAR**.
- The settings of the timer are retained.

The following describes the flow of timer setting.

(Clock)

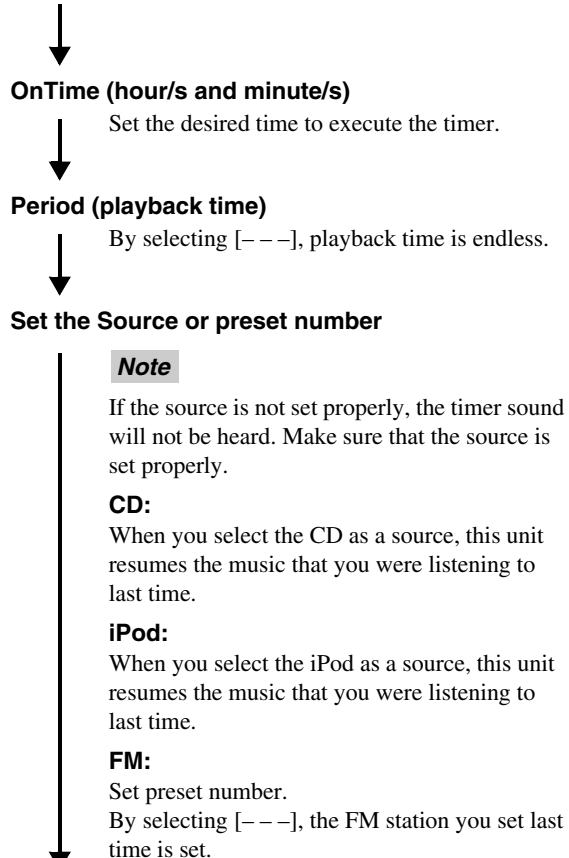

Note

If the source is not set properly, the timer sound will not be heard. Make sure that the source is set properly.

CD:

When you select the CD as a source, this unit resumes the music that you were listening to last time.

iPod:

When you select the iPod as a source, this unit resumes the music that you were listening to last time.

FM:

Set preset number.

By selecting [---], the FM station you set last time is set.

Volume

The volume level can be set between [1] - [MAX] and [--]*1. When the timer is executed while this unit is in standby mode, the volume level you set at this point is applied. When the timer is executed while the unit is on, the volume level remains the same as the current volume level.

*1 If you set your volume level to [--] and the timer is executed while this unit is in standby mode, the volume level is applied at the same level as input source.

Timer setting is complete.

Switch the timer to [OFF]/[ONCE]/[EVERY] by pressing ◀/▶. When the timer is set to [ONCE] or [EVERY], the TIMER indicator lights up on the front panel.

Notes

- The clock has to be set in advance.
- When the timer is set, the TIMER indicator lights up on the front panel. While the power is on, the TIMER indicator flashes as the set time of the timer becomes closer.

■ Setting the sleep timer

The sleep timer sets this unit to standby mode after the specified time elapses.

1 Press **SLEEP** repeatedly.



Operating this unit by TV remote control (the HDMI control function)

You can use the TV remote control to operate this unit if your TV supports the HDMI control function and is connected to this unit's HDMI terminal.

Remote control of TV (Example)

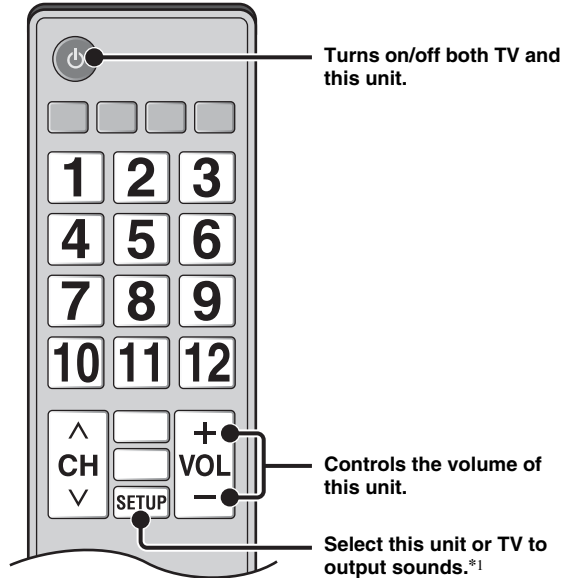

You can also enjoy the following function.

- When you start playback of DVD/BD discs other than CD discs on this unit or display HOME/SETUP menu screen, the input selector of the TV is switched to this unit automatically (One Touch Play).

*1 When you select this unit to output TV sounds by using the TV remote control, the unit automatically selects TV as the input source, and sound can be enjoyed from either the speakers or headphones connected to the unit.

Notes

- The TV needs to be an ARC supported TV.
- This unit may be operated by using cursor buttons of TV remote control for some TVs.
- Even if your TV supports the HDMI control function, some functions may not be available. For details, refer to the manual supplied with your TV.
- HDMI control function may not work properly depending on the TV.
- Functions other than ones shown above may work depending on the TV.

Continued to the next page. ➔

- In order to make the HDMI control function available, set up settings for the HDMI control function on ALL components (this unit, TV, and other components). Certain operation may also be required.
- Each function may be set independently to activate/deactivate depending on the TV.
- Refer to the operation manuals supplied with the TV for details regarding setup.

■ Setting the HDMI control function

1 Turn on all components connected to the TV with HDMI.

2 Check all components connected with HDMI and enable the HDMI control function on each component.

For this unit, set [HDMI Control] to [On] (p. 34).
For external components, refer to the manual supplied with each component.



- The default setting of [HDMI Control] is set to [Off] for this unit.
- The example of TV settings
 - From a setup menu on your TV, select “Link setting” → “HDMI control setting” (example), then set a setting such as “HDMI control function” to “ON” (example).
 - Setting such as “Speaker priority” should be set to “AV amplifier”.

3 Turn off the TV and then turn on it again.

■ Registering HDMI components to TV

1 Select this unit as the input source of the TV.

2 Select Disc/USB/Network as the input source of this unit.

3 Check that the image from this unit is correctly displayed on the TV.

4 Check that the HDMI control function works (turn on this unit or adjust the volume level using the TV remote control).



For some HDMI components, you only need to set the HDMI control function. Registering HDMI components to TV is not required in this case.

If the HDMI control function is not working

Check the following:

- The TV is connected to the HDMI terminal of this unit. The HDMI control function is set to [On] in SETUP menu (p. 34).
- The HDMI control function is enabled on the TV. (Also check the relative settings such as power interlock function or speaker priority.)

The HDMI control function is not working even checking the above

- Turn off this unit and the TV, and then turn them back on again.
- Unplug the AC power supply cable of this unit, the TV and external components connected to the TV with HDMI. Plug them in again after about 30 seconds.

■ Changing the connection method and connected components

When the connected components and jacks are changed, reset this unit with following procedures.



1 Turn off the HDMI control function of the TV and this unit, turn off all connected devices, and change the connections.

2 Perform the step 1 to 3 of “Setting the HDMI control function” (p. 30).

SETUP MENU

The SETUP menu enables various audio/visual settings and adjustments for functions using the remote control unit.

Menu/Submenu	Item	Function	Page		
 General Setting	System	Screen Saver	Sets screen saver to On/Off.	34	
		Auto Power Off	Disc/USB/Net: Sets auto power off mode to On/Off. Other Inputs: Sets auto power off mode to on by hours or Off.	34	
		Disc Auto Playback	Sets this unit to start disc playback automatically.	34	
		HDMI Control	Sets this unit to receive control signal from the remote control of your TV.	34	
		Load Default	Resets all settings to the default setting except Security setting.	34	
		Upgrade	Performs upgrade of this unit.	34	
		Easy Setup	Sets language, resolution, screen aspect ratio.	34	
		Local Storage	Displays status of Local Storage, formats Local Storage and selects the front/rear USB port for Local Storage.	34	
		3D Playback Message	Displays a warning message concerning 3D video playback when this unit is turned on.	34	
		Language	OSD	Selects the language for On Screen Display.	34
			Menu	Prioritizes the language for disc menu.	34
			Audio	Prioritizes the language for audio.	34
			Subtitle	Prioritizes the language for subtitle.	34
		Playback	Closed Caption	Sets the closed caption to On/Off.	35
			Angle Mark	Sets to display the Angle Mark when a BD/DVD disc with multiple angles is played back.	35
			PIP Mark	Sets to display the PIP Mark when a BD/DVD disc with Picture in Picture is played back.	35
			Secondary Audio Mark	Sets to display the Secondary Audio Mark when a BD/DVD disc with secondary audio is played back.	35
			Last Memory	Sets this unit to remember the last playback position of a disc when it is set to standby mode or the disc tray is opened.	35
		Security	Change Password	Changes password for Parental Control and Country Code.	35
			Parental Control	Sets the Parental Control depending on the disc content.	35
			Country Code	Sets your Country Code.	35
		Network	Internet Connection	Sets the internet connection to Enable/Disable.	35
			Information	Displays network information screen.	35
			Connection Test	Performs the network connection test.	35
			IP Setting	Sets the IP setting to Auto/Manual.	35
			BD-Live Connection	Sets the BD-Live connection to Permitted/Partial Permitted/Prohibited.	35
			DLNA	Sets the DLNA to Enable/Disable.	35
			Proxy Setting	Sets the proxy setting.	35

Menu/Submenu	Item	Function	Page		
 Display Setting	TV	3D Output	Selects 3D or 2D videos.	36	
		TV Screen	Sets the screen aspect ratio of the connected TV, and adjust the video output.	36	
		Video Out Select	Selects the resolution of video output.	36	
		TV System	Selects the TV System from NTSC/PAL/Multi.	36	
		Color Space	Selects Color Space from YCbCr 4:4:4/YCbCr 4:2:2/ Full RGB/RGB.	36	
		HDMI Deep Color	Selects HDMI Deep Color from 30 bits/36 bits/Off.	36	
		HDMI 1080p 24Hz	Sets HDMI 1080p 24Hz to Auto/Off.	37	
		Lip Sync	Adjusts the lag between video and audio, such as when the mouth movement is out of sync with the voice.	37	
	Video Process	Video Mode	Adjusts the visual image.	37	
		Color Adjust	Adjusts Brightness/Saturation/Hue for each color.	37	
		Noise Reduction	Sets the level of Noise Reduction.	37	
		De-interlacing Mode	Sets how to detect the video signal.	37	
	 Audio Setting	Audio Output	HDMI	Selects the output mode of HDMI terminal from Bitstream/PCM/Off.	38
			DRC	Sets the DRC (Dynamic Range Compression).	38
Post Process		UpMix	Multi-channelizes the 2-channel audio signal.	38	
 System Information		Displays software version and MAC address (p. 49).	38		

Operation for SETUP menu

You need to display SETUP menu screen to perform settings for this unit. The following is the explanation for basic operations of SETUP menu.

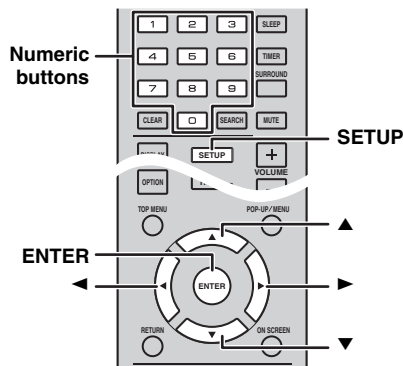

Example: Setting [Parental Control]

Notes

- Some items cannot be set when the input source is set to other than Disc/USB/Network. In this case, set the input source to Disc/USB/Network.
- Some items cannot be set during playback. In this case, press **■** twice to stop playback completely before setting.

- 1 Press **SETUP** to display SETUP menu screen. Press **◀/▶** to select [General Setting], then press **ENTER** or **▼**.

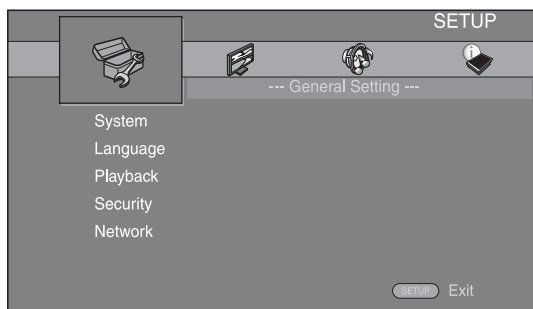

- 2 Select a Submenu. Press **▲/▼** to select [Security], then press **ENTER** or cursor **▶**.

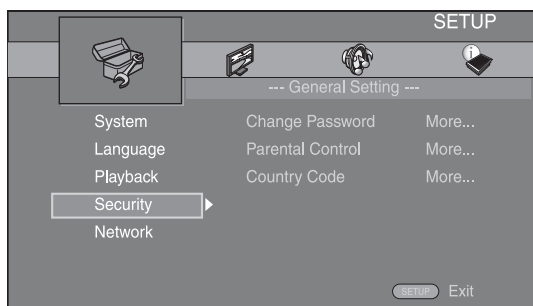

- 3 Select a menu item. Press **▲/▼** to select [Parental Control], then press **ENTER** or cursor **▶**.

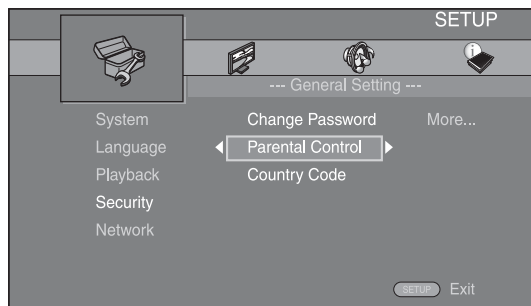

- 4 Enter your password with **Numeric buttons**.
 - The default password is 0000.
 - You cannot move to the next setting screen until you have input the correct password.
 - To change the password, refer to “[Change Password]” (p. 35).

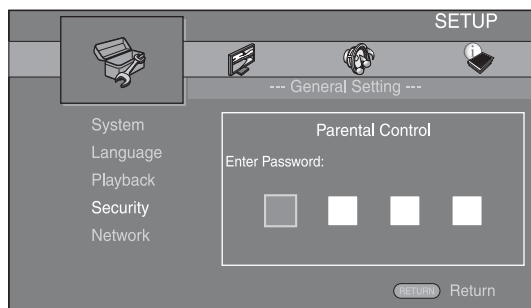

- 5 Select a next item. Press **▲/▼** to select the Parental Control Level for BD/DVD discs, then press **ENTER**.

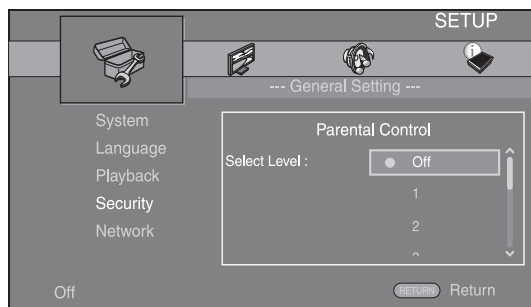

- 6 Exit the menu screen. Press **◀** to return to the previous menu.

General Setting

The default settings are marked with “*”.

■ System

[Screen Saver]

You can set the screen saver to [On]/[Off].
When set to [On], this unit will switch to screen saver mode if there is no operation for 3 minutes.

On*, Off

[Auto Power Off]

You can set auto power off mode to [On]/[Off] when the input is selected to Disc/USB/Network. When other inputs are selected, auto power off mode can be set by hours or to [Off].

Disc/USB/Net: On*, Off

Other Inputs: 1 hour, 2 hours, 4 hours, 8 hours*, Off

[Disc Auto Playback]

You can set [Disc Auto Playback] to [On]/[Off]. When set to [On], a disc will play back automatically after loading.

On*, Off

[HDMI Control]

You can set this unit to receive control signal from a TV compatible with the HDMI control function via an HDMI cable (p. 12).

On, Off*



For details on the HDMI control function, refer to page 29.

Note

When set to [On], power consumption during standby mode increases due to the HDMI control function.

[Load Default]

You can reset all settings of this unit to default setting except Security setting (p. 35). For details on default settings, refer to pages 31-38.

[Upgrade]

You can upgrade the software manually from [USB Storage] or [Network]. For details on software upgrade, refer to “SOFTWARE UPGRADE” (p. 40).

[Easy Setup]

You can perform Easy Setup (p. 14).

[Local Storage]

You can display Local Storage information, format Local Storage, and select [Front USB]/[Rear USB] to save the BD-Live data.

To format (empty) the “BUDA” folder in the USB memory device, select [Information] and press **ENTER** when [Format] is focused on the screen.

Front USB, Rear USB*



Local Storage is used as an auxiliary memory when a BD disc is played back.

[3D Playback Message]

You can turn on or off a warning message concerning 3D video playback that appears on the TV when this unit is turned on.

On*, Off

■ Language

[OSD]

You can select the language for On Screen Display which is the messages or menu displayed on the screen such as SETUP menu.

English, Français, Español, Deutsch, Italiano, Svenska, Nederlandse, Русский, 中文

[Menu]

You can prioritize the language for disc menu.

English, Français, 中文, Español, Deutsch, Italiano, Nederlandse, Portuguese, Danish, Svenska, Finnish, Norwegian, Русский, Korean, Japanese, More

[Audio]

You can prioritize the audio language for BD/DVD playback. For details on setting items, refer to “[Menu]” (p. 34).

[Subtitle]

You can prioritize the language for Subtitle.

English, Français, 中文, Español, Deutsch, Italiano, Nederlandse, Portuguese, Danish, Svenska, Finnish, Norwegian, Русский, Korean, Japanese, More, Off

The default settings in [Language] differ depending on your model.

■ Playback

[Closed Caption]

You can set to display the closed caption (p. 48) when a BD/DVD disc with closed caption is played back.

On, Off*

[Angle Mark]

You can set to display the Angle Mark () when a BD/DVD disc with multiple angles is played back.

On*, Off

[PIP Mark]

You can set to display the PIP Mark () when a BD disc with picture in picture (p. 24) is played back.

On*, Off

[Secondary Audio Mark]

You can set to display the Secondary Audio Mark () when a BD disc with secondary audio is played back.

On*, Off

[Last Memory]

You can set whether this unit remembers the last playback position of a disc when it is set to standby mode or the disc tray is opened.

On*, Off

Note

Some discs are not compatible with this function.

■ Security

[Change Password]

You can set the password for changing the Parental Control Level and Country Code. Refer to “[Parental Control]” (p. 35) and “[Country Code]” (p. 35).

Notes

- The default password is 0000.
- If you forget the password, refer to “TROUBLESHOOTING” (p. 41) and set all the Security settings to their default settings.

[Parental Control]

In some BD/DVD discs, a control level for disc viewing is set depending on the age of the viewer. You can set the Parental Control shown on the screen depending on the disc content.

The password (refer to “[Change Password]” on page 35) needs to be entered before the Parental Control Levels is set.

After you set the Parental Control, when you play back a disc with level higher than current Parental Control Level, or you want to change the Parental Control Level, a dialog box will pop up to ask you to enter the password.

Off*, 1 to 8

[Country Code]

You can set the Country Code you live in. The password (refer to “[Change Password]” on page 35) needs to be entered before the Country Code is set. This setting may be used for rating of the Parental Control and disc playback.

■ Network

[Internet Connection]

You can set to [Enable] when you use BD-Live (p. 24), DLNA (p. 18) and software upgrade from the network (p. 40).

Enable*, Disable

[Information]

You can display network information screen. On this screen, you can view the information of Interface (Ethernet), Address Type, IP Address, Subnet Mask, Default Gateway, and DNS.

[Connection Test]

You can perform an internet connection test. If the test is failed, please check [IP Setting] (p. 35) and perform the test again.

[IP Setting]

You can configure the network settings.

Auto*

Select to automatically configure the network settings of this unit with the DHCP server.

Manual

Select to configure the network settings (IP Address, Subnet Mask, Default Gateway, and DNS) manually.



- **Numeric buttons** Enters characters.
- **◀/▶** Moves the highlight.
- **CLEAR** Deletes a character.
- **ENTER** Saves the settings and exits from the menu.

[BD-Live Connection]

You can set access restriction to BD-Live contents.

Permitted

Allows all BD-Live discs to connect the network.

Partial Permitted*

Allows only discs with owner certification.

Prohibited

Prohibits all BD-Live discs to connect the network.

[DLNA]

You can set the DLNA (p. 18) to [Enable]/[Disable].

When you do not use the DLNA function, set to [Disable].

Enable*, Disable

[Proxy Setting]

You can set Proxy Setting. Set to [Disable] for normal use. Set to [Enable] to set the proxy setting.

Enable

Enables proxy host and proxy port setting.

Disable*

Sets proxy server to disable. Select this item when proxy server is not used.

Proxy Host

Sets proxy host.

Proxy Port

Sets proxy port.

Display Setting

The default settings are marked with “*”.

■ TV

[3D Output]

You can select 3D or 2D video output from this unit.

Auto* This unit automatically selects 3D or 2D videos.

Off This unit always selects 2D videos.

Note

Even if you set [3D Output] to [Auto] and play back a BD 3D disc, this unit selects 2D images depending on the connection and the setting of TV, etc (p. 12).

[TV Screen]

You can set the screen aspect ratio of the connected TV, and adjust the video output.

If you switch your TV (i.e. because you have bought a new one) and the screen aspect ratio of the connected TV changes, you will have to change the TV Screen setting.



16:9 Full Select this when this unit is connected to a TV with a 16:9 screen. When a 4:3 aspect ratio video is played back, the video is displayed as shown below.

16:9 Normal* Select this when this unit is connected to a TV with a 16:9 screen. When a 4:3 aspect ratio video is played back, the video is displayed as shown below.

4:3 Pan Scan Select this when this unit is connected to a TV with a 4:3 screen. When a 16:9 aspect ratio video is played back, the video is displayed as shown below.

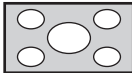
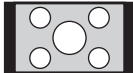
4:3 Letterbox Select this when this unit is connected to a TV with a 4:3 screen. When a 16:9 aspect ratio video is played back, the video is displayed as shown below.

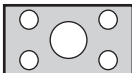
Original image size	On 16:9 (wide screen) TV	
	16:9 Full	16:9 Normal
 <p>4:3</p>		

Original image size	On 4:3 TV	
	4:3 Pan Scan	4:3 Letterbox
 <p>16:9</p>		

[Video Out Select]

You can select the video output resolution from [Composite], [HDMI Auto], [HDMI 1080p], [HDMI 1080i], [HDMI 720p], [HDMI 480p/576p], and [HDMI 480i/576i]. When set to [HDMI Auto], resolution is set to the maximum resolution according to the connected TV. For more details on output formats, refer to “About the video output formats” (p. 39).

Composite, HDMI Auto*, HDMI 1080p, HDMI 1080i, HDMI 720p, HDMI 480p/576p, HDMI 480i/576i

Notes

- When you connect your TV and this unit via the VIDEO jack, select [Composite], [HDMI 480p/576p], or [HDMI 480i/576i].
- To output HD audio (such as Dolby TrueHD or DTS-HD) from the HDMI terminal, set [Video Out Select] to [HDMI Auto] or more than [HDMI 720p].

[TV System]

You can select [TV System] from [PAL], [NTSC] and [Multi]. Set the same TV System as your TV set. For more details on output formats, refer to “About the video output formats” (p. 39).

NTSC, PAL*, Multi (Australia, Asia, China, U.K., Europe and Russia models)

NTSC*, PAL, Multi (Central and South America models)

[Color Space]

You can select the Color Space (p. 48) output from HDMI. This function is available when this unit is connected with an HDMI cable.

YCbCr 4:4:4* Sets Color Space to YCbCr 4:4:4.

YCbCr 4:2:2 Sets Color Space to YCbCr 4:2:2.

Full RGB When RGB is set and white and black on the screen are too faint, select this item. This setting is effective when a connected component supports RGB 0-255 range.

RGB Outputs video signal at normal signal range.

Note

This function is only available on TVs that support this function.

[HDMI Deep Color]

When your TV is compatible with Deep Color (p. 48), set this item according to your TV. This function is available when this unit is connected with an HDMI cable.

30 bits, 36 bits, Off*

[HDMI 1080p 24Hz]

This outputs the BD-Video encoded in 24Hz frame rate in HDMI 1080p 24Hz. Smoother video playback may be available with this function. This function is available when your TV supports this function, and this unit is connected with an HDMI cable. For more details on output formats, refer to “About the video output formats” (p. 39).

Auto*, Off

Note

This setting is disabled when output resolution is other than 1080p.

[Lip Sync]

You can set/adjust the Lip Sync (p. 49) function.

- Auto*** This unit adjusts the Lip Sync function automatically.
- Manual** You can adjust the Lip Sync function manually. You can set the delay of the audio for 2D and 3D contents independently.
 - 2D**
 - 3D**
- Off** This unit does not adjust the Lip Sync function.

■ Video Process

[Video Mode]

You can select [Video Mode] below.

- Standard*** The image is most natural and well-balanced. This mode suits for normal use.
- Vivid** The image is more vivid and sharp.
- Cinema** The image suits for watching movie in dark room.
- Custom** You can adjust the visual image manually. Press ▲/▼ to select the parameter, then press ◀/▶ to adjust the figure.

Brightness
Adjusts the overall brightness of the image.

Saturation
Adjusts the richness of the color in the projected image.

Hue
Adjusts the tint of the projected image.

Contrast
Adjusts the bright areas (white levels) in the image.

Sharpness
Adjusts the sharpness of objects in the video.

CTI
Smooths out the edges of color images. Color images are rendered more distinct.

The default settings are 0.

[Color Adjust]

You can adjust Brightness/Saturation/Hue for each color (Red/Green/Blue/Yellow/Cyan/Magenta). To use this function, set [Video Mode] to [Custom]. For details on the setting items, refer to “[Video Mode]” (p. 37).

The default settings are 0.

[Noise Reduction]

You can set the Noise Reduction to a level of 0 to 3. 0 is off, and 3 is the maximum level.

0*, 1, 2, 3

[De-interlacing Mode]

You can select how to detect the video signal. Set to [Auto] for normal use. When horizontal stripping noise appears on the screen, set this to [Film]/[Video] to remove the noise.

Auto*, Film, Video

Audio Setting

The default settings are marked with “*”.

■ Audio Output

[HDMI]

You can select the output mode of the HDMI terminal.

Bitstream, PCM, Off*

Notes

- To output sound from the speakers or headphones, select [Off].
- No sound of your iPod can be output from this unit to the TV through the HDMI cable.
- To output HD audio (such as Dolby TrueHD or DTS-HD) from the HDMI terminal, set [Video Out Select] to [HDMI Auto] or more than [HDMI 720p] (p. 36).

[DRC]

You can set the DRC (Dynamic Range Compression) (p. 49) to [On]/[Off]/[Auto]. When set to [Auto], DRC is automatically turned on for a source with DRC information in Dolby TrueHD format. DRC makes the strong sound such as plosive sound lower, and conversations more audible. It is useful when you watch movies in the night.

Off*, On, Auto

■ Post Process

[UpMix]

You can multi-channelize the 2-channel audio signal (effective on HDMI output). To multi-channelize, select [DTS NEO:6], then select [Cinema] or [Music].

Off*, DTS NEO:6

■ System Information

Software version and MAC address (p. 49) are displayed.

About the video output formats

When [TV System] is set to [NTSC]

	Resolution	Composite	HDMI Auto	HDMI 480i/576i	HDMI 480p/576p	HDMI 720p	HDMI 1080i	HDMI 1080p	
								24Hz	Others
HDMI	Playback BD	480p	Max	480i	480p	720p 60 Hz	1080i 60 Hz	1080p 24 Hz	1080p 60 Hz
	others							1080p 60 Hz	
VIDEO	Playback BD	480i	OFF	480i	480i	OFF			
	others								

When [TV System] is set to [PAL]

	Resolution	Composite	HDMI Auto	HDMI 480i/576i	HDMI 480p/576p	HDMI 720p	HDMI 1080i	HDMI 1080p	
								24Hz	Others
HDMI	Playback BD	576p	Max	576i	576p	720p 50 Hz	1080i 50 Hz	1080p 24 Hz	1080p 50 Hz
	others							1080p 50 Hz	
VIDEO	Playback BD	576i	OFF	576i	576i	OFF			
	others								

When [TV System] is set to [Multi]

When [TV System] is set to [Multi], video signal is output at the same frequency as the source. Refer to the tables above for details on the frequency setting of the TV and resolution of the output video signal.

While a menu screen such as SETUP menu is displayed, video signal is output at the same frequency as the source.

Notes

- “Max” in the table means that resolution is set to the maximum resolution supported by the connected TV.
- [HDMI 1080p 24Hz] setting is disabled when output resolution is other than [HDMI 1080p].
- No signals are output from the VIDEO jack when output resolution is set to [HDMI Auto], [HDMI 720p], [HDMI 1080i], or [HDMI 1080p].
- When [TV System] is set to [NTSC] and video source is not 60 Hz, the video output signal is converted to 60 Hz.
- When [TV System] is set to [PAL] and video source is not 50 Hz, the video output signal is converted to 50 Hz.

SOFTWARE UPGRADE

Some of the newly released BD discs cannot be played back unless you upgrade this unit software to the latest version. We recommend upgrading the software of this unit with software upgrade so that the unit is operated based on the latest software.

To check for the availability of a software upgrade, visit

<http://download.yamaha.com/>

Note

Do not remove the USB memory device, set this unit to standby mode or unplug the power cable/LAN cable while the software upgrade is being performed.

Upgrading the software

- 1 Prepare for the software upgrade.
When you upgrade the software from [Network]:
Confirm that this unit is connected to the network.
When you upgrade the software from [USB Storage]:
 - ① Save the upgrade file package to the appropriate folder on the USB memory device. For more details, refer to the procedure document attached with the upgrade file package.
 - ② Connect the USB memory device.
If the software upgrade is started automatically when the USB memory is connected, skip step 2 below.
- 2 Select the upgrade method and start upgrade from SETUP menu.
 - ① Press **SETUP** to display SETUP menu screen.
 - ② Select [General Setting] → [System] → [Upgrade].
 - ③ Select the item which contains the upgrade file package from [USB Storage]/[Network].

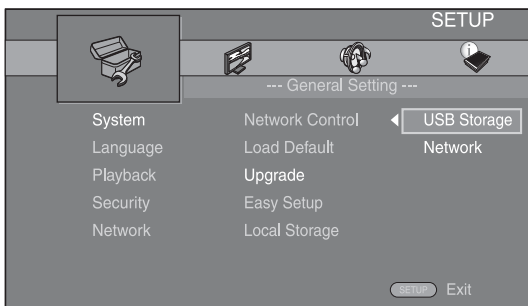







- 3 Start upgrade by following the on-screen messages.

TROUBLESHOOTING

Refer to the table below when this unit does not function properly. If the problem you are experiencing is not listed below or if the instruction below does not help, turn off this unit, disconnect the power cable, and contact the nearest authorized Yamaha dealer or service center.

General

Problem	Cause	Remedy	Page
No power.		Press  on the front panel to turn on the power.	5
This unit fails to turn on or enters standby mode soon after the power is turned on.	The power cable is not connected or the plug is not completely inserted.	Connect the power cable firmly.	11
	This unit has been exposed to a strong external electric shock (such as lightning or strong static electricity).	Set this unit to standby mode, disconnect the power cable, plug it back in after 30 seconds and then use it normally.	—
This unit does not operate properly.	This unit needs to be restarted.	Press and hold  on the front panel for around 5 seconds to restart this unit. To completely restart, unplug the power cable from the AC outlet for 5 to 10 seconds, plug the power cable to the AC outlet again, and then turn on this unit.	5
The disc cannot be played back.	The Initial Wizard is not set.	Set the Initial Wizard when you turn this unit on for the first time after purchase or upgrade.	14
No sound.	No appropriate input source has been selected.	Select an appropriate input source with INPUT on the front panel (or the Input select buttons on the remote control).	5
	Speaker connections are not secure.	Secure the connections.	10
	The mute function is on.	Cancel the mute function.	7
	The volume is turned down.	Turn up the volume.	7
	Signals this unit cannot reproduce are being input from a source component, such as a CD-ROM.	Play a source whose signals can be reproduced by this unit.	3
	[HDMI Control] is set to [Off].	When connecting ARC (Audio Return Channel) supported TV and this unit using an HDMI cable only, set [HDMI Control] to [On].	34
No sound from the speakers or headphones.	[HDMI] for audio output in SETUP menu is not set to [Off].	Set [HDMI] to [Off].	38
No picture.	Incorrect cable connections.	Make sure that the cables are connected correctly.	12
		Make sure that the connected TV is set to the correct input.	12
		Connect this unit to the TV with VIDEO jack using the supplied video pin cable. – If picture is still not displayed with this unit connected to the VIDEO jack, press and hold  and  on the front panel simultaneously for around 5 seconds when no disc is inserted and playback is stopped to switch NTSC/PAL.	12
	TV system is set incorrectly.	Press and hold  and  on the front panel simultaneously for around 5 seconds when no disc is inserted and playback is stopped to switch NTSC/PAL. Set resolution properly again when connecting through HDMI (p. 36).	—

Problem	Cause	Remedy	Page
The power is suddenly turned off.	The sleep timer is set.	This is not malfunction. Turn on this unit and play the source again.	29
	[Auto Power Off] is set to [On].	Set [Auto Power Off] to [Off].	34
The clock setting has been cleared.	The power cable has been disconnected.	Connect the power cable, and set the clock again.	—
Sound is heard from the speaker on one side only.	Incorrect cable connections.	Connect the cables properly. If the problem persists, the cables may be defective.	10
There is noise interference from digital or radio frequency equipment.	This unit is too close to the digital or high-frequency equipment.	Move this unit farther away from such equipment.	—
This unit makes a snapping sound when starting playback or loading a disc.		These sounds are not malfunctions of this unit but are normal operating conditions.	—
No sound from the subwoofer.	The subwoofer is not connected properly.	Check that the subwoofer is connected properly.	10
The system settings change automatically.	When [HDMI Control] is set to [On], operations of the TV (for example, changing channels, etc.) changes the system settings.	Set [HDMI Control] to [Off] or set the system again by using its remote control.	34
The HDMI control function does not work properly.	[HDMI Control] is set to [Off].	Set [HDMI Control] to [On].	34
	The HDMI control function is disabled on your TV.	Refer to the manual supplied with your TV and check the setting.	—
The automatic lipsync is not effective even [Lip Sync] is set to [Auto].	The TV does not support the automatic lipsync.	Set [Lip Sync] to [Manual] and then manually adjust the audio output delay.	37

Radio reception

Problem	Cause	Remedy	Page
FM stereo reception is noisy.	The antenna is connected improperly.	Check the antenna connections.	10
	The characteristics of FM stereo broadcasts cause this problem when the transmitter is too far away or the antenna input is poor.	Try using a high-quality directional FM antenna.	—
		Switch to monaural mode.	26
The desired station cannot be tuned into with the automatic tuning method.	The signal is too weak.	Use a high-quality directional FM antenna.	—
		Use the manual tuning method.	26
The preset selecting function does not work.	The preset (memory) has been erased.	Preset radio stations again.	26
There is distortion, and clear reception cannot be obtained even with a good FM antenna or an outdoor antenna.	Multipath reflection or other radio interference has occurred.	Change the height, direction, or placement of the antenna.	—

iPod

Note

In case of a transmission error without a status message appearing on the front panel display of this unit, check the connection to your iPod (refer to page 11).

Status message	Cause	Remedy	Page
READING	This unit is in the middle of recognizing the connection with the iPod.	If the message continues to appear on the front panel display and playback does not start, connect the iPod again.	—
UNKNOWN	There is a problem with the signal path from the iPod to this unit.	Connect the iPod again.	11
	The iPod being used is not supported by this unit.	Only iPod classic, iPod nano (2nd, 3rd, 4th, 5th and 6th generation), iPod touch (1st, 2nd, 3rd, and 4th generation), iPhone, iPhone 3G/3GS, iPhone 4, and iPad are supported.	11
	The iPod software is out of date.	Update the iPod software version to the latest.	—
STOP	The play back of the iPod is finished. For example, all the songs in the selected album have finished being played back.		
NO iPod	The iPod was disconnected from this unit.	Connect the iPod and this unit by a USB cable correctly.	11

Problem	Cause	Remedy	Page
No sound.	The power of this unit is off.	Connect the power cable correctly.	11
	The iPod software version has not been updated.	Download the latest iTunes software to update the iPod software version to the latest.	—
	The iPod is in the process of connecting with this unit.	Please wait for a while.	—
No sound.	The iPod is not connected correctly.	Connect the iPod and this unit by a USB cable correctly.	11
The iPod sounds, but you cannot operate it with this unit or the remote control.			
No sound of your iPod from the TV.	No sound of your iPod can be output from this unit to the TV through the HDMI cable.	Use the speakers of this unit.	—
This unit cannot be operated by the remote control.	The iPod is not supported by this unit.	Only iPod classic, iPod nano (2nd, 3rd, 4th, 5th and 6th generation), iPod touch (1st, 2nd, 3rd, and 4th generation), iPhone, iPhone 3G/3GS, iPhone 4, and iPad are supported.	11
	The iPod is not connected correctly.	Connect the iPod and this unit by a USB cable correctly.	11
	The iPod software version is out of date.	Update the iPod software version to the latest. If the problem cannot be solved, even with the latest software, reset the iPod.	—
You cannot operate from the iPod.	The iPod is not connected correctly.	Connect the iPod and this unit by a USB cable correctly.	11
The playback information is not displayed on the front panel display.	The iPod you set is not compatible with the playback information display.	Only iPod classic, iPod nano (2nd, 3rd, 4th, 5th and 6th generation), iPod touch (1st, 2nd, 3rd, and 4th generation), iPhone, iPhone 3G/3GS, iPhone 4, and iPad are supported.	11

Problem	Cause	Remedy	Page
The iPod does not charge up.	The iPod is not connected correctly.	Connect the iPod and this unit by a USB cable correctly.	11
	The iPod is not supported by this unit.	Only iPod classic, iPod nano (2nd, 3rd, 4th, 5th and 6th generation), iPod touch (1st, 2nd, 3rd, and 4th generation), iPhone, iPhone 3G/3GS, iPhone 4, and iPad are supported.	11

USB

Note

In case of a transmission error without a status message appearing on the front panel of this unit, check the connection to the USB device (refer to page 13).



Status message	Cause	Remedy	Page
USB ERROR	The connected USB device is not playable on this unit.	Disconnect the USB device. Change input source other than USB and select USB as input source again. Then connect playable USB device again.	13
	The USB device is connected at an angle.		

Problem	Cause	Remedy	Page
The file in the USB device does not play.	The USB device is not recognized.	Connect the USB device again.	13
		Connect an AC adapter if supplied with the device.	—
	Incorrect USB device connections.	Connect the USB device again.	13
	The file format is not compatible with this unit.	Replace the file with a correctly recorded file playable with this unit.	3
	If the solutions above do not resolve the problem, the USB device is not playable on this unit.	Try another USB device.	—



Disc playback

■ General

Problem	Cause	Remedy	Page
No sound or distorted sound.	The sampling rate of an audio or video file is not compatible with this unit.	Check that the sampling rate and bit rate of an audio or video file are compatible with this unit.	3
		Audio may not be output depending on the audio recording status, such as when audio other than an audio signal or non-standard audio is recorded for the audio content.	3
		There is no sound during still mode, slow motion playback, fast forward and fast reverse.	—

Problem	Cause	Remedy	Page
Disc playback does not start.	The disc is not finalized.	The CD-R/RW, DVD+R/RW/R DL, and DVD-R/RW/R DL must be finalized.	3
	Disc is loaded upside-down.	Remove the disc and then load the disc with the labeled side facing up.	—
	The disc is defective.	Try playing back another disc. If this solves the problem, the disc you want to play back is defective.	—
	The format of the file is not compatible with this unit.	Check that the format of the file is compatible with this unit.	3
Some button operations do not work.	The disc loaded into this unit is not compatible.	Use a disc supported by this unit.	3
Playback does not start immediately after pressing  on this unit or  on the remote control.	The disc is dirty.	Remove the disc and then wipe the disc clean.	4
	The disc loaded into this unit is not compatible.	Use a disc supported by this unit.	3
	If this unit was moved from a cold to warm place, condensation has formed on the disc reading lens.	Wait for an hour or two until this unit adjusts to the room temperature, and try again.	—
[No Disc] appears in the display even though a disc is in the disc tray.	The disc loaded into this unit is not compatible.	Use a disc supported by this unit.	3
	The disc is dirty.	Remove the disc and then wipe the disc clean.	4
	Disc is loaded upside-down.	Remove the disc and then load the disc with the labeled side facing up.	—
Audio is not output, or images are not played back properly.	The disc is a copyright-protected disc.	The audio may not be output or the images may not be played back properly for some discs in which copyright-protected contents are recorded.	—

Picture

Problem	Cause	Remedy	Page
Screen freezes and operation buttons do not work.		Press  , then restart playback.	—
	This unit needs to be restarted.	Turn off the power and turn on the power again.	—
		Press and hold  on the front panel for around 5 seconds to restart this unit.	—
Video is not output with the desired resolution.	Resolution is set incorrectly.	Set to the desired resolution.	36
Wide-screen video appears vertically stretched, or black bands appear at the top and bottom of the screen. Or 4:3 video appears horizontally stretched.	Aspect ratio of your TV is set incorrectly.	Change the aspect ratio of your TV.	36
Square noise (mosaic) appears on the screen.		Blocks in images may be visible in scenes with rapid movement due to the characteristics of digital image compression technology.	—
The playback screen will be disturbed if DVD video is recorded to a VCR, or played back through a VCR.	The disc is a copyright-protected disc.	This unit complies with analog copy protection. Some discs contain a copy prohibiting signal. If you try to play back such discs through a VCR, or record to a VCR and play back the signal, the copy protection will prevent normal playback.	—

Remote control

Problem	Cause	Remedy	Page
The remote control does not work nor function properly.	The remote control is operated outside its operation range.	For information on the remote control operation range, refer to "Using the remote control".	9
	The remote control sensor on this unit is exposed to direct sunlight or lighting.	Change the lighting or orientation of this unit.	—
	The battery is worn out.	Replace the battery with new one.	9
	There are obstacles between the sensor of this unit and the remote control.	Remove the obstacles.	—

Network

Problem	Cause	Remedy	Page
Cannot connect to the Internet.	Incorrect cable connections.	Connect the Network cable properly.	13
	The connected equipment is turned off.	Turn on the connected equipment, such as the broadband router or modem.	—
	Connections of the broadband router and/or modem are incorrect.	Connect the broadband router and/or modem correctly.	—
	The network setting is incorrect.	Set the proper value(s) in the network setting. Refer to "Network".	35
Cannot download BD-Live contents.	Incorrect cable connections.	Connect the Network cable properly.	13
	Incorrect USB device connections.	Connect the USB memory device properly. Check that the USB memory device is connected to the USB port of this unit.	13
	The BD disc does not support BD-Live.	Check if the BD disc supports BD-Live.	—
	The network setting is incorrect.	Check the setting for [Internet Connection].	35
	The USB memory device is not compatible.	Connect the USB memory device formatted in FAT16 or FAT32.	13
	There is insufficient free space on the USB memory device.	It is recommended to connect the USB memory device with at least 2 GB of free space. If there is not enough free space, format the USB memory device.	34
	Refer to the supplied user's manual of the disc or consult the disc manufacturer.	—	
Cannot detect the DLNA server.	Incorrect cable connections.	Connect the network cable properly.	13
	The connected equipment is turned off.	Turn on the connected equipment, such as the broadband router or the server.	—
	The access point of this unit and the server are not the same.	Confirm this unit and the server are connected to the same access point.	—
	The network setting is incorrect.	Set the proper value(s) in the network setting. Refer to "Network".	35
	The DLNA server does not permit this unit.	Depending on the DLNA server, this unit may need to be permitted from the server.	—
Cannot play the file on the home network server.	The file is not supported by this unit.	Make sure the file is playable.	3
	The DLNA setting is incorrect.	Check your DLNA server's setting.	35
		The playback and operating quality may be affected by your home network condition.	—

Messages on the screen

The following messages appear on the TV screen in case the disc you tried to play back is not appropriate or the operation is not correct.

Error message	Cause	Remedy	Page
Unsupported File	The file is not supported by this unit.	Refer to “Types of discs/files that can be used with this unit”.	3
Wrong region code!	The disc is an incompatible region code.	Refer to “Region management information”.	3
Network has FAILED.	This unit cannot be connected to the network.	Check connection and Network setting.	13 35
Network is OK, proxy has FAILED.	This unit cannot be connected to the proxy server.	Refer to “[Proxy Setting]”.	35
BD-Live connection is prohibited in SETUP menu.	BD-Live connection is prohibited.	Refer to “[BD-Live Connection]”.	35
No valid upgrade file is found!	The upgrade file cannot be found.	Check if the upgrade file is in the appropriate folder.	—
Upgrade has failed for some reason!	Upgrade is failed.	Check if the upgrade file is corrupted or unreadable.	—

Others

Problem	Cause	Remedy	Page
Password is forgotten.		When no disc is inserted and playback is stopped, press and hold ■ and ▲ on the front panel simultaneously for around 5 seconds to set all the Security settings (p. 35) of this unit to their default settings. After the power is turned off automatically, press ⏻ to turn on the power again.	—

GLOSSARY

AIR SURROUND XTREME

This unit employs new technologies and algorithms that make it possible to achieve 5-channel surround sound with only front speakers, and without using wall reflections.

Ordinarily, two front speakers, a center speaker, two surround speakers, and a subwoofer are necessary for enjoying 5.1 channel surround sound.

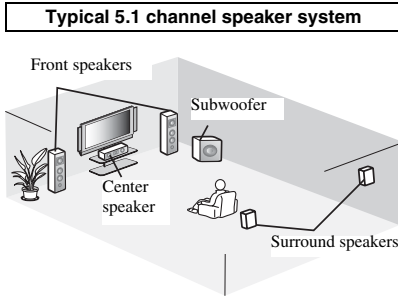

Virtual 5.1 channel

The AIR SURROUND XTREME technology, using only front speakers, enables you to enjoy a realistic 5.1 channel sound by simulating sound from virtual speakers at center and surround.

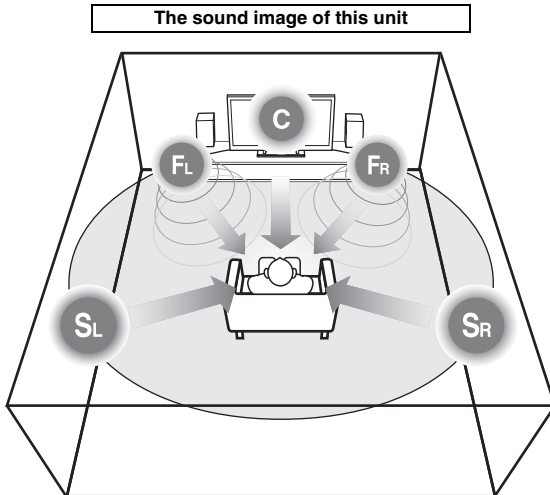

The system creates the virtual 5.1 channel surround sound with the speakers.

C: Center speaker

FR, FL: Front speakers

SR, SL: Surround virtual speakers

AVCHD

AVCHD is a new format (standard) for high definition video cameras that can be used to record and play high-resolution HD images.

BD-Live™

BD-Live is a BD standard that utilizes a network connection, enabling this unit to go online to download promotional videos and other data.

BDMV

BDMV (Blu-ray Disc Movie, BD-MV) refers to one of the application formats used for BD-ROM which is one of the Blu-ray Disc specifications. BDMV is a recording format equivalent to DVD-Video of the DVD specification.

Blu-ray 3D™

Blu-ray 3D enables you to view full high definition 3D images.

BONUSVIEW™

BONUSVIEW compatible discs let you simultaneously enjoy video sub-channel for two screens, audio sub-channel and sub-titles. A small screen appears within the main screen during playback (Picture in Picture).

Closed caption

Closed captions are kind of subtitle, and the difference between subtitles and captions is that subtitles are intended for hearing persons and captions are for the hearing impaired. Subtitles rarely show all of the audio. For example, captions show sound effects (e.g., “phone ringing” and “footsteps”), while subtitles do not. Before you select this setting, please ensure that the disc contains closed caption information.

Color Space

Color Space is a color range that can be represented. RGB is a color space based on the RGB color model (red, green and blue) and is typically used for PC monitors. YCbCr is a color space based on a luminance signal (Y) and two color difference signals (Cb and Cr).

Deep Color

Deep Color refers to the use of various color depths in displays, up from the 24-bit depths in previous versions of the HDMI specification. This extra bit depth allows HDTVs and other displays go from millions of colors to billions of colors and eliminate on-screen color banding for smooth tonal transitions and subtle gradations between colors. The increased contrast ratio can represent many times more shades of gray between black and white. Also Deep Color increases the number of available colors within the boundaries defined by the RGB or YCbCr color space.

Dolby Digital

A sound system developed by Dolby Laboratories Inc. that gives movie theater ambience to audio output when the product is connected to a Dolby Digital processor or amplifier.

Dolby Digital Plus

A sound system developed as an extension to Dolby Digital. This audio coding technology supports 7.1 multi-channel surround sound.

Dolby TrueHD

Dolby TrueHD is a lossless coding technology that supports up to 8 channels of multi-channel surround sound for the next generation optical discs. The reproduced sound is true to the original source bit-for-bit.

DRC (Dynamic Range Control)

DRC lets you adjust the range between the loudest and softest sounds (dynamic range) for playback at average volume. Use this when it is hard to hear dialog, or during times when playback may disturb neighbors.

DTS

This is a digital sound system developed by DTS, Inc. for use in cinemas.

DTS-HD High Resolution Audio

DTS-HD High Resolution Audio is a new technology developed for the next generation high definition optical disc format.

HDMI

HDMI (High-Definition Multimedia Interface) is an interface that supports both video and audio on a single digital connection. The HDMI connection carries standard to high definition video signals and multi-channel audio signals to AV components such as HDMI equipped TVs, in digital form without degradation.

Letterbox (LB 4:3)

A screen size with black bars on the top and bottom of the image to allow viewing of wide-screen (16:9) material on a connected 4:3 TV.

Linear PCM Sound

Linear PCM is a signal recording format used for Audio CDs and on some DVD and Blu-ray discs. The sound on Audio CDs is recorded at 44.1 kHz with 16 bits. (Sound is recorded between 48 kHz with 16 bits and 96 kHz with 24 bits on DVD discs and between 48 kHz with 16 bits and 192 kHz with 24 bits on BD discs.)

Lip Sync

Lip Sync, an abbreviation for lip synchronization, is a technical term that involves both a problem and a capability of maintaining audio and video signals synchronized during post-production and transmission. Whereas the audio and video latency requires complex end-user adjustments, HDMI incorporates an automatic audio and video syncing capability that allows devices to perform this synchronization automatically and accurately without user interaction.

Mac address

The Mac address is a unique value assigned to a network device for identification purposes.

Pan Scan (PS 4:3)

A screen size that cuts off the sides of the image to allow viewing of wide-screen (16:9) material on a connected 4:3 TV.

Subtitles

These are the lines of text appearing at the bottom of the screen which translate or transcribe the dialog. They are recorded on many DVD and BD discs.

Top menu

In a BD-Video/DVD-Video, this is the menu for selecting things like the chapter to be played back and the subtitle language. In some DVD-Videos, the top menu may be called the "Title Menu".

x.v.Color

x.v.Color reproduces a greater range of color than before, showing almost all of the colors that the human eye can detect.

SPECIFICATIONS

PLAYER SECTION

iPod/iPhone/iPad

- Supported iPod/iPhone/iPad iPod classic, iPod nano (2nd, 3rd, 4th, 5th and 6th generation), iPod touch (1st, 2nd, 3rd, and 4th generation), iPhone, iPhone 3G/3GS, iPhone 4, iPad

disc and file formats

- For supported disc and file formats, refer to page 3.

AUX

- Input connector
AUX RCA

AMPLIFIER SECTION

- Maximum output power 30 W + 30 W
(1 kHz, 10% THD, 6 Ω)
- Input sensitivity/Input impedance
AUX 400 mV/47 k Ω
- Total harmonic distortion
AUX 1 kHz/10 W 0.05 %

TUNER SECTION

- Tuning range 87.50 to 108.00 MHz

INPUT/OUTPUT

- HDMI output Type A connector \times 1
480i/576i, 480p/576p, 720p, 1080i, 1080p, 1080p/24Hz,
Deep Color, x.v.Color, 3D,
ARC(Audio Return Channel) support
- Video output 1 Vp-p (75 Ω)
- USB Type A connector \times 2
- Other equipment Ethernet \times 1

GENERAL

- Power Supply
[Europe model] AC 220-240 V, 50/60 Hz
[Asia model] AC 220-240 V, 50/60 Hz
[Australia model] AC 240 V, 50 Hz
[U.K. model] AC 230 V, 50 Hz
[China model] AC 220-240 V, 50/60 Hz
[Korea model] AC 220 V, 60 Hz
[Russia model] AC 220-240 V, 50/60 Hz
[Central and South America model] AC 100-120 V, 50/60 Hz
- Power consumption 56 W
- Standby Power consumption 0.5 W or less
- Dimensions (W \times H \times D, including protrusions)
..... 215 \times 114.5 \times 306.3 mm
(8 1/2 \times 4 5/8 \times 12 1/8 in)
- Weight 3.0 kg (6.6 lbs.)

Specifications are subject to change without notice.

■ Copyright

- iPad, iPhone, iPod, iPod classic, iPod nano, and iPod touch are trademarks of Apple Inc., registered in the U.S. and other countries.

“Made for iPod,” “Made for iPhone,” and “Made for iPad” mean that an electronic accessory has been designed to connect specifically to iPod, iPhone, or iPad, respectively, and has been certified by the developer to meet Apple performance standards. Apple is not responsible for the operation of this device or its compliance with safety and regulatory standards. Please note that the use of this accessory with iPod, iPhone, or iPad may affect wireless performance.

- Audio-visual material may consist of copyrighted works which must not be recorded without the authority of the owner of the copyright. Refer to relevant laws in your country.
- This product incorporates copyright protection technology that is protected by U.S. patents and other intellectual property rights. Use of this copyright protection technology must be authorized by Rovi Corporation, and is intended for home and other limited viewing uses only unless otherwise authorized by Rovi Corporation. Reverse engineering or disassembly is prohibited.
- This product is licensed under the AVC patent portfolio license and VC-1 patent portfolio license for the personal and non-commercial use of a consumer to (i) encode video in compliance with the AVC Standard and VC-1 Standard (“AVC/VC-1 Video”) and/or (ii) decode AVC/VC-1 Video that was encoded by a consumer engaged in a personal and non-commercial activity and/or was obtained from a video provider licensed to provide AVC/VC-1 Video. No license is granted or shall be implied for any other use. Additional information may be obtained from MPEG LA, LLC. See <http://www.mpegla.com>.

- Windows Media Player is a registered trademark or trademark of Microsoft corporation in the United States and/or other countries.

- YouTube and the YouTube logo are trademarks of Google, Inc.

-  is a trademark of DVD Format/Logo Licensing Corporation.



- Manufactured under license from Dolby Laboratories. Dolby and the double-D symbol are trademarks of Dolby Laboratories.



- Manufactured under license under U.S. Patent Nos: 5,956,674; 5,974,380; 6,226,616; 6,487,535; 7,212,872; 7,333,929; 7,392,195; 7,272,567 & other U.S. and worldwide patents issued & pending. DTS-HD, the Symbol, & DTS-HD and the Symbol together are registered trademarks of DTS, Inc. Product includes software. © DTS, Inc. All Rights Reserved.



- Blu-ray Disc™, Blu-ray™, Blu-ray 3D™, BD-Live™, BONUSVIEW™, and the logos are trademarks of the Blu-ray Disc Association.



BONUS VIEW™

- HDMI, the HDMI logo and High-Definition Multimedia Interface are trademarks or registered trademarks of HDMI Licensing LLC.



- “x.v.Color” and “x.v.Color” logo are trademarks.

x.v.Color

- “AVCHD” and the “AVCHD” logo are trademarks of Panasonic Corporation and Sony Corporation.



- Java and all Java-based trademarks and logos are trademarks or registered trademarks of Sun Microsystems, Inc. in the United States and/or other countries.



- DLNA and DLNA CERTIFIED are trademarks and/or service marks of Digital Living Network Alliance.



- This unit employs new technologies and algorithms that make it possible to achieve 5-channel surround sound with only front speakers, and without using wall reflections.



ADDITIONAL INFORMATION

English

PRECAUCIÓN: LEA LAS INDICACIONES SIGUIENTES ANTES DE UTILIZAR ESTE APARATO

- 1 Para asegurar el mejor rendimiento de este aparato, lea atentamente este manual. Y luego guárdelo en un lugar seguro para poder consultarlo en el futuro en caso de ser necesario.
- 2 Instale esta unidad en un lugar bien ventilado, fresco, seco y limpio, alejado de la luz directa del sol, fuentes de calor, vibración, polvo, humedad y/o frío. Para una adecuada ventilación, permita que el equipo tenga el siguiente espacio libre mínimo:
Arriba: 10 cm
Atrás: 10 cm
A los lados: 10 cm
- 3 Coloque este aparato lejos de otros aparatos eléctricos, motores o transformadores, para evitar así los ruidos de zumbido.
- 4 No exponga este aparato a cambios bruscos de temperaturas, del frío al calor, ni lo coloque en lugares muy húmedos (una habitación con deshumidificador, por ejemplo), para impedir así que se forme condensación en su interior, lo que podría causar una descarga eléctrica, un incendio, daños en el aparato y/o lesiones a las personas.
- 5 Evite instalar este aparato en un lugar donde puedan caerle encima objetos extraños y/o donde quede expuesto al goteo o a la salpicadura de líquidos. Encima de este aparato no ponga:
 - Otros componentes, porque pueden causar daños y/o decoloración en la superficie de este aparato.
 - Objetos con fuego (velas, por ejemplo), porque pueden causar un incendio, daños en el aparato y/o lesiones a las personas.
 - Recipientes con líquidos, porque pueden caerse y derramar el líquido, causando descargas eléctricas al usuario y/o dañando el aparato.
- 6 No tape este aparato con un periódico, mantel, cortina, etc. para no impedir el escape del calor. Si aumenta la temperatura en el interior del aparato, esto puede causar un incendio, daños en el aparato y/o lesiones a las personas.
- 7 No enchufe este aparato a una toma de corriente hasta después de haber terminado todas las conexiones.
- 8 No ponga el aparato al revés. Podría recalentarse y posiblemente causar daños.
- 9 No utilice una fuerza excesiva con los conmutadores, los controles y/o los cables.
- 10 Cuando desconecte el cable de alimentación de la toma de corriente, sujete la clavija y tire de ella; no tire del propio cable.
- 11 No limpie este aparato con disolventes químicos porque podría estropear el acabado. Utilice un paño limpio y seco para limpiar el aparato.
- 12 Utilice solamente la tensión especificada en este aparato. Utilizar el aparato con una tensión superior a la especificada resulta peligroso y puede producir un incendio, daños en el aparato y/o lesiones a las personas. Yamaha no se hará responsable de ningún daño debido al uso de este aparato con una tensión diferente de la especificada.
- 13 Para impedir daños debidos a relámpagos, desconecte el cable de alimentación y antenas externas de la toma de corriente durante una tormenta eléctrica.
- 14 No intente modificar ni arreglar este aparato. Póngase en contacto con el personal de servicio Yamaha cualificado cuando necesite realizar alguna reparación. La caja no deberá abrirse nunca por ninguna razón.
- 15 Cuando no piense utilizar este aparato durante mucho tiempo (cuando se ausente de casa por vacaciones, por ejemplo) desconecte el cable de alimentación de la toma de corriente.
- 16 Asegúrese de leer la sección “SOLUCIÓN DE PROBLEMAS” antes de dar por concluido que su aparato está averiado.
- 17 Antes de trasladar este aparato, pulse  para ponerlo en el modo de espera, y luego desconecte el cable de alimentación de CA de la toma de corriente.
- 18 La condensación se formará cuando cambie de repente la temperatura ambiental. Desconecte en este caso el cable de alimentación de la toma de corriente y no utilice el aparato.
- 19 El aparato se calentará cuando la utilice durante mucho tiempo. Desconecte en este caso la alimentación y luego no utilice el aparato para permitir que se enfríe.
- 20 Instale este aparato cerca de la toma de CA y donde se pueda alcanzar fácilmente la clavija de alimentación.
- 21 Las baterías no deberán exponerse a un calor excesivo como, por ejemplo, el que producen los rayos del sol, el fuego y similares.
- 22 La presión acústica excesiva de los auriculares puede causar pérdida auditiva.

Este aparato no se desconecta de la fuente de alimentación de CA si está conectada a una toma de corriente, aunque la propia aparato esté apagada con . A este estado se le llama modo de espera. En este estado, este aparato ha sido diseñada para que consuma una cantidad de corriente muy pequeña.

ADVERTENCIA

PARA REDUCIR EL RIESGO DE INCENDIO O DESCARGA ELÉCTRICA, NO EXPONGA ESTE APARATO A LA LLUVIA NI A LA HUMEDAD.

SEGURIDAD CONTRA LA RADIACIÓN LÁSER

Este aparato utiliza rayos láser. Debido a la posibilidad de que se produzcan daños en los ojos, la extracción de la cubierta del aparato o las reparaciones solamente deberán ser realizadas por un técnico cualificado.

PELIGRO

Este aparato emite radiación láser visible cuando se abre. Evite la exposición directa a los rayos láser. Cuando se conecte este aparato a una toma de corriente no acerque sus ojos a la abertura de la bandeja del disco ni a otras aberturas para mirar al interior.

ADVERTENCIA

NO TOQUE ESTA UNIDAD SI SE UTILIZA DE FORMA CONTINUA A UN VOLUMEN ELEVADO, YA QUE SU PARTE INFERIOR PODRÍA ACUMULAR MUCHO CALOR Y PODRÍA SUFRIR LESIONES O QUEMADURAS.

CONTENIDO

INTRODUCCIÓN

FUNCIONES DE ESTA UNIDAD	2
PIEZAS INCLUIDAS	2
INFORMACIÓN SOBRE DISCOS Y ARCHIVOS	3
Tipos de discos/archivos que se pueden utilizar con esta unidad	3
Para cargar un disco.....	4
Precauciones con los discos.....	4
Aviso para ver imágenes de vídeo en 3D	4
PANEL DELANTERO Y FUNCIONAMIENTO BÁSICO	5
MANDO A DISTANCIA	6
Colocación de las pilas en el mando a distancia.....	9
Utilización del mando a distancia.....	9

PREPARACIÓN

CONEXIÓN	10
Conexión de un sistema con distintos componentes a esta unidad	10
Otra conexión.....	11
Conexión de un televisor	12
Conexión HDMI.....	12
Conexión de vídeo	12
CONEXIÓN DE RED Y USB	13
Conexión con el terminal NETWORK.....	13
Conexión al puerto USB.....	13

FUNCIONAMIENTO

ASISTENTE INICIAL/CONFIGURACIÓN SENCILLA	14
Configuración con el Asistente inicial/Configuración Sencilla.....	14
FUNCIONAMIENTO BÁSICO	15
Funcionamiento básico con el menú HOME/MEDIA	15
Reproducción de Foto/Música/Vídeo	16
Uso del contenido de red	18
Reproducción de vídeos desde YouTube™ (Solo modelos de Asia y América Central y del Sur)	18
Funcionamiento básico sin el menú HOME/MEDIA	19
Funcionamiento para iPod.....	20
Operaciones con un CD	20
FUNCIONAMIENTO DE REPRODUCCIÓN AVANZADO	21
Menú en pantalla.....	21
Menú de estado.....	22
Uso de Marcador.....	23
Reproducción de programa.....	23
Uso de la búsqueda.....	24
Disfrutar de BONUSVIEW™ y BD-Live™	24
ESCUCHAR EMISORAS DE RADIO FM	26
Sintonización de emisoras de radio	26
Preajuste de emisoras de radio.....	26
Selección de emisoras de radio presintonizadas (Sintonización de presintonías)	26
UTILIZACIÓN DE FUNCIONES ÚTILES	27
Utilización del menú de opciones del visor del panel delantero.....	27
Ajuste del reloj/temporizador y del temporizador de apagado	28
Control de esta unidad con el mando a distancia del televisor (función de control HDMI).....	29

AJUSTES

MENÚ SETUP	31
Utilización del menú SETUP	33
Configuración General.....	34
Configuración de pantalla.....	36
Configuración de audio	38
Acerca de los formatos de salida de vídeo.....	39
ACTUALIZACIÓN DE SOFTWARE	40
Actualización del software	40

INFORMACIÓN ADICIONAL







SOLUCIÓN DE PROBLEMAS	41
Problemas generales	41
Recepción de la radio.....	42
iPod	43
USB	44
Reproducción de disco.....	44
Mando a distancia	46
Red	46
Mensajes en pantalla.....	47
Otros	47
GLOSARIO	48
ESPECIFICACIONES	50

■ Acerca de este manual

- Este manual describe cómo utilizar esta unidad con un mando a distancia, excepto cuando éste no se encuentre disponible. También se puede acceder a algunas de estas operaciones mediante los botones del panel delantero.
- Las notas contienen información importante acerca de las instrucciones de seguridad y funcionamiento.  indica una sugerencia de funcionamiento.
- “iPod” puede hacer referencia también a “iPhone” o “iPad” en este manual.
- Este manual se ha impreso antes de la fabricación. El diseño y las especificaciones están sujetos a cambios en parte como resultado de mejoras, etc. En caso de diferencias entre el manual y el producto, este último tiene prioridad.

Iconos utilizados en este manual

Los iconos se utilizan para indicar botones/funciones disponibles para un formato en concreto.

-  : Vídeo BD
-  : Vídeo DVD, DVD-VR, DVD+VR
-  : CD de audio
-  : AVCHD, WMV
-  : MP3, WMA, WAV
-  : JPEG

FUNCIONES DE ESTA UNIDAD

Reproducir un Blu-ray Disc™/DVD/CD*1 comercializado en el mercado → **pág. 21**

Además de un Blu-ray Disc™ (disco BD), esta unidad también admite la reproducción de muchos otros discos.

Reproducir BONUSVIEW™, BD-Live™, etc.*1 → **pág. 24**

Puede disfrutar de películas adicionales en los discos BD más recientes.

Reproducir archivos de vídeo, música o fotos de un disco/ dispositivos de memoria USB/iPod/iPhone/iPad*1 → **pág. 15**

Con esta unidad se pueden reproducir archivos grabados en discos/dispositivos de memoria USB/iPod/iPhone/iPad.

Reproducir archivos de vídeo, música y fotos de un servidor doméstico de red*1, 2 → **pág. 18**

El contenido del PC se puede reproducir en el televisor conectando esta unidad a un servidor de red.

Reproducir contenidos de YouTube™ publicados en Internet (Solo modelos de Asia y América Central y del Sur)*2 → **pág. 18**

Con esta unidad puede disfrutar al instante de contenidos de YouTube™ publicados en Internet.

Sintonizar emisoras de radio FM → **pág. 26**

Con esta unidad puede sintonizar emisoras de radio FM.

Utilizar las opciones Asistente inicial/Configuración Sencilla → **pág. 14**

Puede configurar fácilmente el idioma, la resolución y la relación de aspecto de la pantalla con la pantalla Asistente inicial/Configuración Sencilla.

Usar el mando a distancia del televisor → **pág. 29**

Puede conectar dispositivos con un cable HDMI y controlarlos con un único mando a distancia utilizando la función de control HDMI.

Reproducir sonidos envolventes virtuales de alta calidad con AIR SURROUND XTREME → **pág. 16**

Puede disfrutar del exclusivo sistema AIR SURROUND XTREME de Yamaha, que reproduce sonidos envolventes virtuales de alta calidad.

*1 Para obtener información sobre los discos y archivos que se pueden reproducir, consulte la página 3.

*2 Para utilizar esta función es necesaria la configuración de red.

PIEZAS INCLUIDAS

Asegúrese de que dispone de todos los elementos siguientes.

Mando a distancia

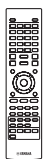

Pilas (x2) (AAA, R03, UM-4)

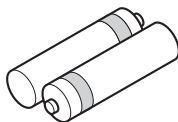

Antena de FM para interior*3

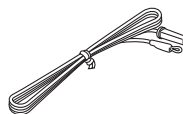

Cable de vídeo compuesto (1,5 m)

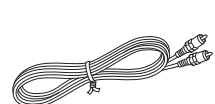







*3 La antena de FM para interior suministrada es diferente en función del modelo.









INFORMACIÓN SOBRE DISCOS Y ARCHIVOS

Tipos de discos/archivos que se pueden utilizar con esta unidad

- En esta unidad se pueden reproducir discos de 12 cm y 8 cm. No utilice un adaptador de 8 cm a 12 cm.
- Utilice discos que sean compatibles con los estándares que se indican con la presencia de logotipos oficiales marcados en la etiqueta del disco. La reproducción de discos que no cumplan con estos estándares no está garantizada. Además, la calidad de imagen o sonido no está garantizada incluso si tales discos se pueden reproducir.

Tipo de disco	Formato de grabación	Formato de datos
BD-ROM/BD-R/ BD-RE	Vídeo BD	--
DVD-ROM	Vídeo DVD	--
DVD-R/DVD-R DL/ DVD-RW	Vídeo DVD/DVD- VR/AVCHD/disco de datos	WMV/MP3/WAV/ WMA/JPEG
DVD+R/DVD+R DL/DVD+RW	Vídeo DVD/ DVD+VR/AVCHD/ disco de datos	WMV/MP3/WAV/ WMA/JPEG
CD-ROM	CDDA/HDCD	--
CD-R/CD-RW	CDDA/disco de datos	WMV/MP3/WAV/ WMA/JPEG
USB	--	WMV/MP3/WAV/ WMA/JPEG
Red	--	WMV/MP3/WMA/ WAV/JPEG

Información de gestión de la región		
Destino	Vídeo BD	Vídeo DVD
Asia	Código de región "A" o "ALL" 	Número de región "3" o "ALL" 
América Central y del Sur	Código de región "A" o "ALL" 	Número de región "4" o "ALL" 
Corea	Código de región "A" o "ALL" 	Número de región "3" o "ALL" 

Información de gestión de la región		
Destino	Vídeo BD	Vídeo DVD
Europa	Código de región "B" o "ALL" 	Número de región "2" o "ALL" 
Australia	Código de región "B" o "ALL" 	Número de región "4" o "ALL" 
Rusia	Código de región "C" o "ALL" 	Número de región "5" o "ALL" 
China	Código de región "C" o "ALL" 	Número de región "6" o "ALL" 

- Los discos y los reproductores de vídeo BD/DVD tienen códigos de región, que dictan las regiones en las que se puede reproducir un disco.
- Las operaciones y funciones de vídeo BD/DVD pueden ser diferentes de las explicaciones que aparecen en este manual y algunas operaciones pueden estar prohibidas debido a las configuraciones del fabricante del disco.
- Si se visualiza una pantalla de menú o instrucciones de funcionamiento durante la reproducción de un disco, siga el procedimiento de funcionamiento visualizado.

Notas

- Según el disco, puede que no sea posible la reproducción de algunos de los discos de las tablas de la columna izquierda.
- Finalice todos los soportes de grabación que se reproduzcan en esta unidad.
- "Finalizar" hace referencia a un procesamiento del grabador sobre un disco grabado para que se pueda reproducir en otros reproductores/grabadores, así como en esta unidad. Solo se podrán reproducir en la unidad los discos que se hayan finalizado. (Esta unidad no dispone de una función para finalizar discos.)
- No se garantiza la reproducción de todos los archivos del disco, dispositivo de memoria USB y red.
- Un archivo con propiedad intelectual protegida no se puede reproducir a través de un dispositivo de memoria USB o red.

Requisitos de archivos de audio MP3/WMA

- Frecuencia de muestreo: entre 32 – 48 kHz (MP3/WMA), LPCM 44,1 kHz/16 bits/estéreo (WAV)
- Bitrate: entre 8 – 320 kbps (MP3), 32 – 192 kbps (WMA)

Requisitos de archivos WMV

- WMV9, la resolución máxima es 1.920 × 1.080.

Para cargar un disco

- Inserte el disco con la etiqueta hacia arriba.
- En el caso de un disco grabado por ambas caras, ponga boca abajo el lado que desea reproducir.

Notas

- La reproducción puede iniciarse automáticamente, dependiendo del disco y la configuración de la unidad.
- Es posible que el menú aparezca primero según el disco.
- El tiempo necesario para cargar el disco puede variar dependiendo del disco.

Precauciones con los discos

- No toque la superficie del disco. Sujételo por el borde (y por el orificio del centro).
- No utilice lápices ni rotuladores de punta fina para escribir en el disco.
- No ponga cinta, productos sellantes, pegamento ni otros materiales similares en un disco.
- No utilice una funda protectora para evitar los arañazos.
- No cargue más de un disco en la unidad al mismo tiempo. Si lo hace, esta unidad y los discos pueden sufrir daños.
- No introduzca cuerpos extraños en la ranura del disco.
- No cargue discos rotos, deformados ni con pegamento.
- No exponga los discos a la luz solar directa, altas temperaturas, niveles altos de humedad ni entornos con mucho polvo.

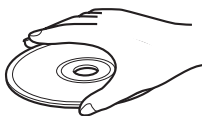

Precaución



- Si un disco se ensucia, límpielo con un paño limpio y seco empezando por el centro y terminando en el borde. No utilice productos de limpieza para discos de vinilo ni diluyentes.
- Para evitar problemas de funcionamiento, recomendamos no utilizar productos de limpieza de lentes comercializados en tiendas.

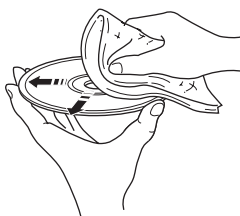

Aviso para ver imágenes de vídeo en 3D

- Algunas personas pueden sufrir molestias (como vista cansada, fatiga o náuseas) al ver imágenes de vídeo en 3D. Se recomienda a todos los espectadores realizar pausas periódicas durante la visualización de imágenes de vídeo en 3D.
- Si sufre alguna molestia, deje de ver las imágenes de vídeo en 3D hasta que ésta desaparezca. Consulte con un médico si sufre molestias agudas.
- Lea atentamente los manuales de instrucciones (televisor y disco BD) y los mensajes de precaución que aparecen en el televisor.
- La vista de los niños pequeños (especialmente de los menores de seis años) todavía está en proceso de desarrollo. Consulte con su médico (como un pediatra o un oftalmólogo) antes de permitir a niños pequeños ver imágenes de vídeo en 3D.
- Los niños pequeños deben estar bajo la supervisión de un adulto para garantizar que siguen las recomendaciones descritas anteriormente.

PANEL DELANTERO Y FUNCIONAMIENTO BÁSICO

- ☀️
Esta unidad cuenta con una función de espera automática.
- Al utilizar Disco/USB/Red como fuente, se activa automáticamente el modo de espera si la unidad está encendida durante 1 hora sin reproducir contenidos ni realizar ninguna otra operación.
 - Si NO utiliza Disco/USB/Red como fuente, se activa automáticamente el modo de espera si la unidad está encendida durante entre 1 y 8 horas sin reproducir contenidos ni realizar ninguna otra operación, en función del ajuste configurado en el menú SETUP (pág. 34).

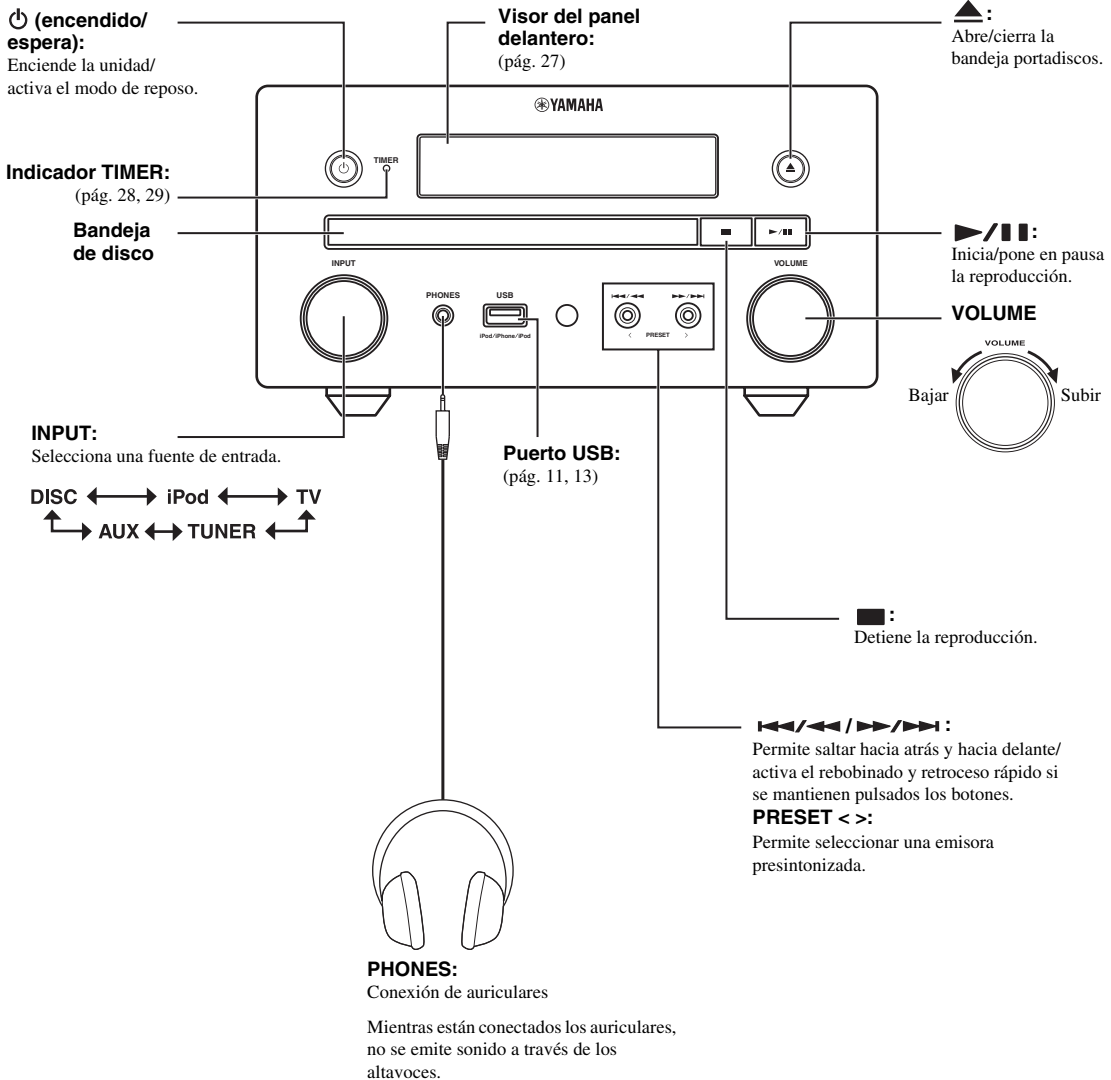

MANDO A DISTANCIA

Nota



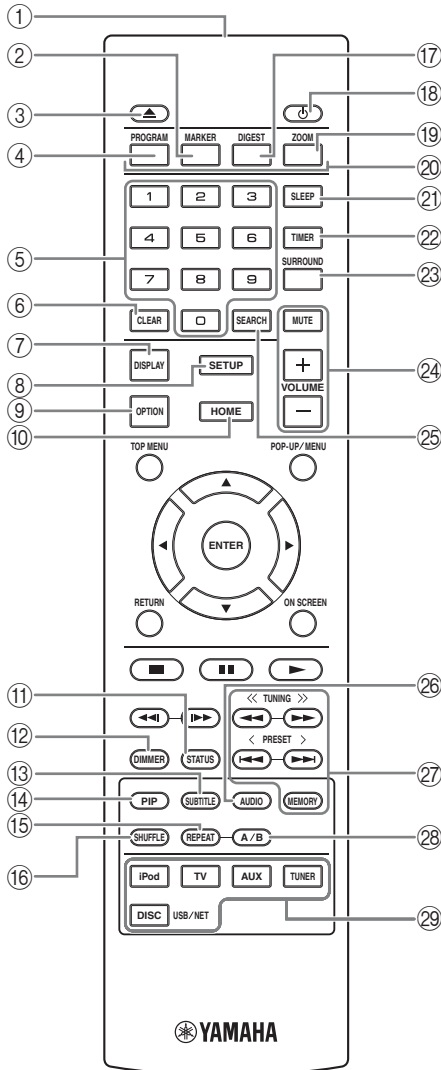

En la esquina superior izquierda de la pantalla aparecerá  cuando la tecla pulsada no esté disponible.



- ① **Transmisor de señal infrarroja** (pág. 9)
- ② **MARKER [DVD VIDEO]**: crea un Marcador en un punto especificado de una película (pág. 23). Tras definir un Marcador, pulse **DIGEST** para seleccionar el punto de ajuste al que desea saltar. Puede definir hasta 12 marcadores.
- ③ **▲**: abre/cierra la bandeja portadiscos.
- ④ **PROGRAM [DVD CD]**: establece el orden de reproducción (pág. 23). Puede configurar hasta 15 pistas de un disco de audio o títulos/capítulos de un DVD de vídeo.
- ⑤ **Botones numéricos**: permiten introducir números o, durante la reproducción, saltar a la pista/capítulo correspondiente al número introducido. Es posible que estos botones no estén disponibles en función del tipo de disco y la situación de reproducción.
- ⑥ **CLEAR**: borra el número introducido o elemento configurado.
- ⑦ **DISPLAY**: cambia la información mostrada en el visor del panel delantero (pág. 20).
- ⑧ **SETUP**: muestra la pantalla de menú SETUP (pág. 31).
- ⑨ **OPTION**: activa el modo del menú de opciones (pág. 27).
- ⑩ **HOME**: muestra la pantalla de menú HOME (pág. 16).
- ⑪ **STATUS**: muestra la información de reproducción en la pantalla (pág. 22).
- ⑫ **DIMMER**: cambia el brillo del visor del panel delantero. Puede elegir el nivel de brillo entre brillante o apagado pulsando este botón varias veces.
- ⑬ **SUBTITLE [BD DVD VIDEO]**: permite cambiar el idioma de los subtítulos (pág. 49) si está disponible. También puede seleccionar este elemento desde el menú en pantalla (pág. 21).
- ⑭ **PIP [BD]**: permite encender/apagar la función Imagen en imagen (pág. 24). Marca PIP () se muestra en pantalla cuando esta función está disponible. También puede seleccionar este elemento desde el menú en pantalla (pág. 21).

Nota

Marca PIP se muestra solo cuando la opción [Marca PIP] está ajustada en [Activar] (pág. 35).

- ⑮ **REPEAT [BD DVD CD VIDEO MUSIC PHOTO]**: permite seleccionar el modo de repetición. El modo de repetición mostrado a continuación cambiará cada vez que pulse el botón (pág. 20, 22).
 - : repite el título que se está reproduciendo.
 - : repite el capítulo que se está reproduciendo.
 - : repite la carpeta que se está reproduciendo.
 - : repite todas las pistas/archivos del disco/carpeta.
 - : repite la pista/archivo que se está reproduciendo.
- ⑯ **SHUFFLE [DVD CD VIDEO MUSIC PHOTO]**: permite seleccionar el modo de reproducción aleatoria (pág. 20, 21).

- ⑰ **DIGEST PHOTO** : muestra 12 fotografías en miniatura. Cuando se muestran las miniaturas, puede ir a la página siguiente o anterior con **◀◀ / ▶▶** .
- DVD VIDEO** : muestra la barra de selección Marcador (pág. 23).
- ⑱ **⏻** : enciende la unidad o activa el modo de reposo.
- ⑲ **ZOOM DVD VIDEO PHOTO** : amplía/reduce la imagen. El tamaño de la pantalla cambiará cada vez que pulse la tecla (ampliar/reducir imagen: 3 pasos cada uno).
- ⑳ **Botones de colores BD** : utilice estos botones siguiendo las instrucciones en pantalla.
- ㉑ **SLEEP** : activa el modo de reposo (pág. 29).
- ㉒ **TIMER** : activa el modo de temporizador (pág. 28).
- ㉓ **SURROUND** : activa o desactiva el modo de reproducción envolvente de los altavoces (pág. 16). (No afecta el sonido de los auriculares.)
- ㉔ **Botones de control del volumen** : controlan el nivel del volumen (pág. 16).
Pulse **MUTE** para desactivar el volumen. Púlselo de nuevo para reanudar el volumen.
- ㉕ **SEARCH BD DVD CD VIDEO MUSIC** : permite saltar a un punto especificado durante la reproducción. Para obtener más información sobre esta función, consulte "Uso de la búsqueda" (pág. 24). También puede seleccionar esta opción desde el menú Estado (pág. 22).
- ㉖ **AUDIO BD DVD** : permite cambiar el idioma o formato de audio. También puede seleccionar esta opción desde el menú en pantalla (pág. 21).
- ㉗ **FM Botones de control**
TUNING << / >> : inicia la sintonización manual. Mantenga pulsado este botón para iniciar la sintonización automática (pág. 26).
PRESET < / > : permite seleccionar las emisoras presintonizadas (pág. 26).
MEMORY : inicia la sintonización de presintonías y memoriza emisoras presintonizadas (pág. 26).
- ㉘ **A/B BD DVD CD VIDEO MUSIC** : permite reproducir una parte específica que desee repetir.
- 1 Pulse **A/B** en la escena donde desee definir el punto de inicio. [A-] aparecerá en la pantalla.
 - 2 Pulse **A/B** de nuevo en la escena donde desee definir el punto final. [A-B] aparecerá en la pantalla.
Se inicia la reproducción de repetición.
 - 3 Para cancelar la reproducción de repetición, pulse **A/B**. [A-B] desaparecerá y se detendrá la reproducción de repetición.
- Nota**
- Es posible que esta función no se pueda utilizar dependiendo de las especificaciones del disco.
- ㉙ **Botones de selección de entrada** : permiten seleccionar la fuente de entrada (pág. 15, 19, 26).

Continúa en la página siguiente. ➔

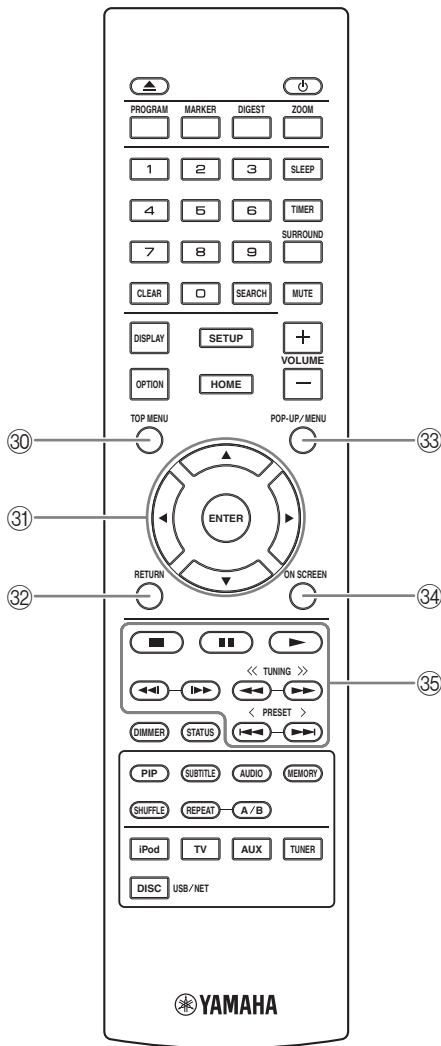

- ③① **TOP MENU** **[BD DVD]** : muestra la pantalla del menú principal (pág. 49) si el disco contiene un menú. Seleccione la opción deseada con **▲/▼/◀/▶** y **ENTER**.

Nota

Las operaciones concretas pueden diferir dependiendo del disco. Siga las instrucciones de cada pantalla de menú.

- ③② **Botones de cursor** (**▲/▼/◀/▶**): permiten desplazarse hasta la opción deseada.
ENTER: confirma el menú o la opción señalado.
- ③③ **RETURN**: permite volver al menú o pantalla anterior, etc.
- ③④ **POP-UP/MENU** **[BD DVD]** : muestra el menú emergente. Los contenidos del menú que se visualiza varían en función del disco. Para obtener más información sobre cómo ver y controlar el menú emergente, consulte el manual del disco. La pantalla del menú principal se puede mostrar pulsando **POP-UP/MENU**, dependiendo del disco.
- ③⑤ **ON SCREEN**: muestra el menú en pantalla (pág. 21).

Botones de control

[BD DVD CD VIDEO MUSIC PHOTO] :

▶ : reproduce el contenido.

■ : detiene la reproducción. Para detener totalmente la reproducción, pulse dos veces este botón.

⏸ : sitúa la reproducción en pausa.

[BD DVD CD VIDEO MUSIC] :

⏮ / ⏭ : permite saltar hacia atrás/hacia adelante.

⏮ / ⏭ : pulse este botón para realizar una búsqueda o una repetición instantánea. La búsqueda instantánea salta 30 segundos en el contenido. La repetición instantánea reproduce el contenido desde 10 segundos antes.

[BD DVD CD VIDEO MUSIC] :

⏮ / ⏭ : permite realizar búsquedas hacia atrás/hacia adelante. La velocidad de búsqueda cambiará cada vez que pulse el botón (buscar hacia atrás/adelante: 5 pasos cada opción). Pulse **▶** para reanudar la reproducción normal.

[PHOTO] :

⏮ / ⏭ : permite cambiar la velocidad de un pase de diapositivas (más lento/más rápido: 3 pasos).

Nota

En función del disco, la unidad reanuda la reproducción desde el punto en el que se paró anteriormente. Para reproducir desde el principio, pulse **■** y, después, pulse **▶** .

Colocación de las pilas en el mando a distancia

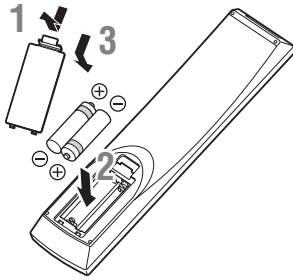

■ Notas acerca de las pilas

- Cambie las dos pilas cuando la distancia de funcionamiento del mando a distancia disminuya.
- Utilice pilas AAA, R03 o UM-4.
- Asegúrese de que las polaridades son correctas. Consulte la ilustración del interior del compartimento de las pilas.
- Retire las pilas si no va a utilizar el mando a distancia durante un período prolongado.
- No mezcle pilas usadas con pilas nuevas.
- No utilice diferentes tipos de pilas juntas (como, por ejemplo, pilas alcalinas y de manganeso). Fíjese bien en el embalaje, ya que estos diferentes tipos de pilas a menudo tienen el mismo tamaño y color.
- Si una pila tiene fugas, tírela inmediatamente siguiendo las regulaciones. Nunca toque el líquido que salga de la pila ni permita que entre en contacto con la ropa. Limpie a conciencia el compartimento de las pilas antes de colocar pilas nuevas.
- No tire las pilas con los residuos domésticos habituales. Deséchelas de acuerdo con las normativas de su país.
- Mantenga las pilas fuera del alcance de los niños. Si alguien ingiere una pila de forma accidental, póngase en contacto inmediatamente con un médico.
- Si sabe que no va a utilizar el mando a distancia durante un largo período de tiempo, retire las pilas del mando a distancia.
- No cargue ni desmonte las pilas suministradas.

Utilización del mando a distancia

El mando a distancia transmite una señal mediante un haz infrarrojo. Oriente siempre el mando a distancia hacia el sensor del mando a distancia del panel delantero de esta unidad cuando lo utilice.

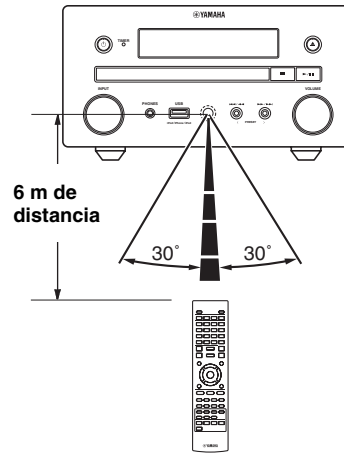

Notas

- El espacio entre el mando a distancia y esta unidad debe estar despejado de obstáculos.
- No vierta agua ni otros líquidos en este mando a distancia.
- No deje caer el mando a distancia.
- No guarde ni deje el mando a distancia en lugares con:
 - elevada humedad, como por ejemplo un baño;
 - elevada temperatura, como por ejemplo un radiador;
 - temperaturas extremadamente bajas;
 - mucho polvo.
- No exponga el mando a distancia a una iluminación excesiva, como una lámpara fluorescente de inversor, ya que podría averiarse. Si es necesario, coloque el sistema lejos de fuentes de iluminación directa.

CONEXIÓN

Conexión de un sistema con distintos componentes a esta unidad

Asegúrese de leer el siguiente procedimiento y la nota con atención antes de conectar el sistema.

■ Conexión del sistema

- 1 Conecte los terminales de los altavoces (L) de esta unidad a los terminales de los altavoces del altavoz izquierdo y los terminales de los altavoces (R) de esta unidad a los terminales de los altavoces del altavoz derecho con los cables de altavoz suministrados con el juego de altavoces (NS-BP150).
- 2 Conecte la antena FM suministrada a la toma FM.

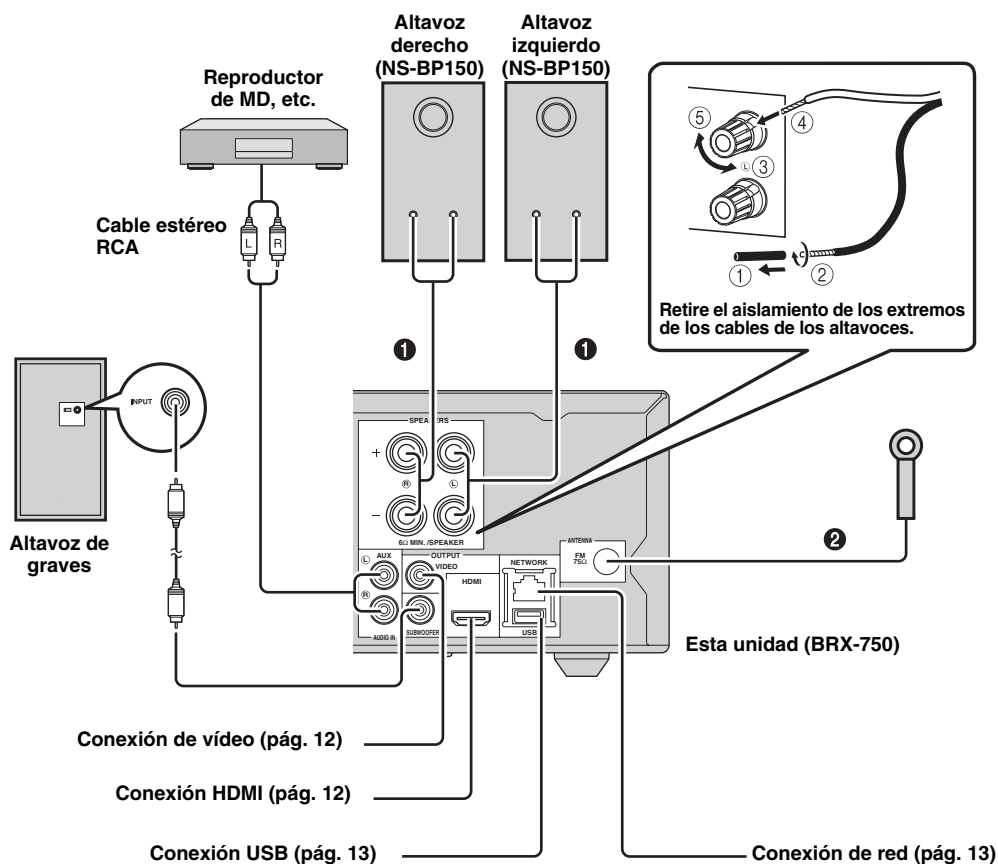

PRECAUCIÓN

- No conecte esta unidad ni los demás componentes a la alimentación hasta que todas las conexiones entre los componentes estén a punto.
- No deje que los cables de altavoces desnudos entren en contacto entre sí ni toquen partes metálicas de esta unidad, ya que podrían dañar la unidad y/o los altavoces.
- Todas las conexiones deben realizarse correctamente: L (izquierdo) con L, R (derecho) con R, “+” con “+” y “-” con “-”. Si las conexiones están mal, los altavoces no reproducirán sonido, y si la polaridad de las conexiones de los altavoces no es correcta, el sonido no será natural y faltarán los graves. Consulte también el manual del propietario de cada uno de sus componentes.

Notas

- Si conecta altavoces que no sean del modelo NS-BP150, procure que tengan una impedancia superior a 6 Ω.
- Si la recepción de las ondas de radio es débil en su zona o desea mejorar la recepción, le recomendamos usar antenas exteriores comercializadas en tiendas. Para obtener más información, consulte al concesionario Yamaha o centro de servicio autorizado más cercano.

Otra conexión

■ Conexión del iPod

Puede disfrutar de la música que tiene en su iPod conectándolo a esta unidad.

Nota

Esta unidad es compatible con iPod classic, iPod nano (2ª, 3ª, 4ª, 5ª y 6ª generación), iPod touch (1ª, 2ª, 3ª y 4ª generación), iPhone, iPhone 3G/3GS, iPhone 4 y iPad.

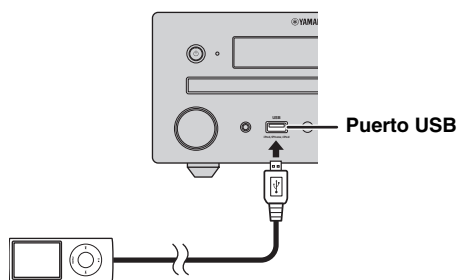

Notas

- Compruebe que el cable USB que une el iPod con esta unidad esté bien conectado.
- Conecte el iPod al puerto USB frontal de esta unidad. El puerto USB posterior no es compatible con el iPod.

■ Conexión del cable de alimentación

Tras realizar todas las conexiones, conecte los cables de alimentación de esta unidad.

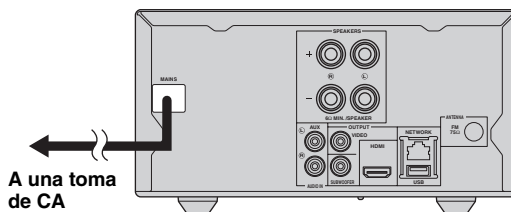

Conexión de un televisor

Es importante que tome nota de las indicaciones de esta ilustración para realizar correctamente las conexiones entre esta unidad y el televisor.

PRECAUCIÓN

No conecte el cable de alimentación de esta unidad hasta que haya realizado todas las conexiones.

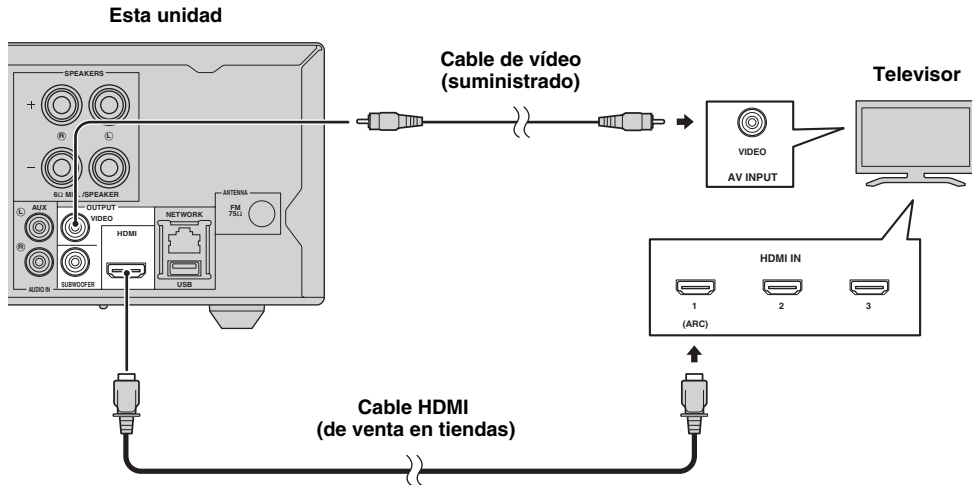

Conexión HDMI

- Puede disfrutar de imagen y sonido digital de alta calidad a través de los terminales HDMI.
- Conecte con firmeza un cable HDMI (de venta en tiendas) al terminal HDMI de esta unidad.
- Utilice cables HIGH SPEED HDMI que tengan el logotipo HDMI (pág. 51).



- Cuando utilice la función de control HDMI, consulte “Control de esta unidad con el mando a distancia del televisor (función de control HDMI)” (pág. 29) y “[Control HDMI]” (pág. 34).
- Para más información sobre el modo de salida del terminal HDMI, consulte “[HDMI]” (pág. 38).
- Si no se muestra la imagen, consulte “SOLUCIÓN DE PROBLEMAS” (pág. 41).

■ Conexión para la reproducción de discos 3D de Blu-ray

Debe disponer de los siguientes equipos y conexiones para disfrutar de discos 3D BD en esta unidad:

- Un televisor con tecnología 3D
- Conexión del televisor y esta unidad mediante cables HDMI
- Un disco BD con imágenes en 3D

■ Acerca de los televisores con canal de retorno de audio (ARC)

- Puede conectar un cable HDMI al terminal compatible con el canal de retorno de audio (el terminal con la indicación “ARC”) del televisor.
- Deberá activar la función de control HDMI de esta unidad para activar el canal de retorno de audio (ARC) (pág. 34).

¿Qué es el canal de retorno de audio (ARC)?

Esta función permite reproducir la señal de audio digital de un televisor a través de esta unidad mediante un cable HDMI, sin necesidad de utilizar un cable de clavijas de audio digital.



Si su televisor no es compatible con ARC, conecte el televisor y esta unidad mediante las tomas AUX de esta unidad.

Conexión de vídeo

- Conecte con firmeza el cable de vídeo compuesto (suministrado) al terminal VIDEO.
- Consulte página 39 para obtener información sobre los formatos de salida de vídeo.

Notas

- Si reproduce la imagen mediante una videgrabadora, la imagen puede deteriorarse debido a la función de protección contra copia.
- Para disfrutar de discos 3D BD en esta unidad, deberá conectar un televisor y esta unidad con cables HDMI (de venta en tiendas).

CONEXIÓN DE RED Y USB

Conexión con el terminal NETWORK

- El contenido del PC se puede reproducir conectando esta unidad a la red.
- Puede disfrutar de numerosos contenidos con funciones interactivas gracias a la conexión a Internet al reproducir discos compatibles con BD-Live. Consulte página 24 para obtener más información sobre las funciones BD-Live.

Notas

- Conecte con firmeza un cable de red (de venta en tiendas) al terminal NETWORK.
- Utilice únicamente un cable de red STP (par trenzado blindado).
- Al utilizar Internet, se necesita una conexión a Internet de banda ancha como se muestra más abajo.
- Conecte el otro conector del cable de red al nodo/enrutador de banda ancha.
- Cuando utilice una conexión a Internet de banda ancha, es necesario un contrato con un proveedor de servicios de Internet. Para más información, póngase en contacto con su proveedor de servicios de Internet más cercano.
- Consulte el manual de instrucciones del equipo, ya que el equipo conectado y el método de conexión pueden variar dependiendo de su entorno de Internet.
- Emplee un cable de red/enrutador compatible con 10BASE-T/100BASE-TX.

Conexión al puerto USB

- Puede conectar un dispositivo de memoria USB (2 GB o más con formato FAT 32/16) para Almacenamiento Local BD al puerto USB del panel posterior (o delantero) de esta unidad para guardar los datos BD-Live (pág. 25) o para actualizar el software de esta unidad (pág. 40).
- Conecte un dispositivo de memoria USB (de venta en tiendas) al puerto USB.

PRECAUCIÓN

- No desconecte el dispositivo de memoria USB ni desenchufe el cable de alimentación mientras se estén realizando las operaciones de BD-Live o se esté llevando a cabo la actualización del software.
- No utilice un cable de extensión USB cuando conecte un dispositivo de memoria USB al puerto USB de esta unidad. El uso de un cable de extensión USB puede impedir que la unidad funcione correctamente.

Notas

- Yamaha no puede garantizar que todas las marcas de dispositivos de memoria USB funcionen con esta unidad.
- Para obtener más información sobre el uso de dispositivos de memoria USB, consulte página 15.

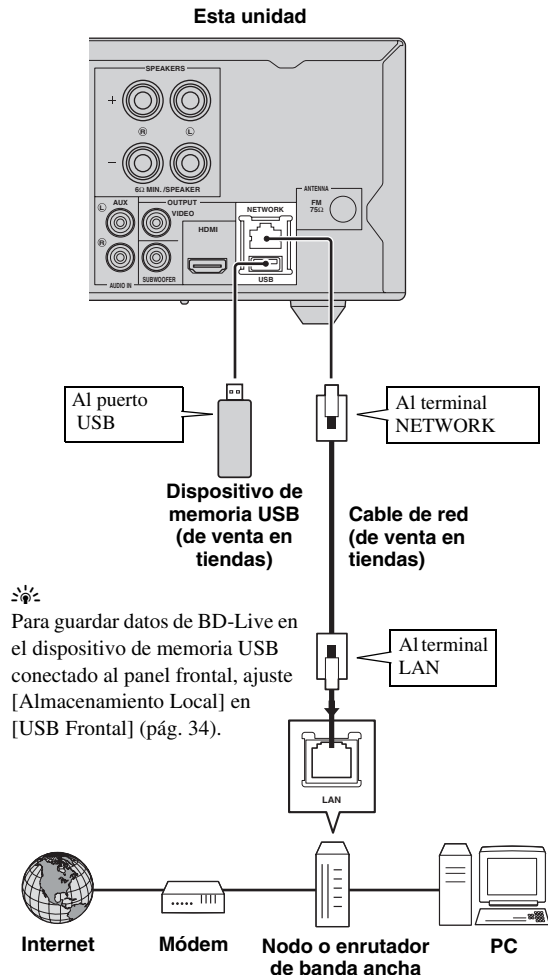

Después de la conexión

- Para configurar el parámetro Red manualmente, consulte “Red” (pág. 35).
- Para reproducir el contenido del PC en su red, consulte “Uso del contenido de red” (pág. 18).

ASISTENTE INICIAL/CONFIGURACIÓN SENCILLA

Configuración con el Asistente inicial/Configuración Sencilla

Asistente inicial/Configuración Sencilla le permite definir con facilidad el idioma, la resolución y la relación de aspecto de pantalla. La pantalla Asistente inicial se muestra cuando enciende la unidad por primera vez después de la compra o actualización. El mismo ajuste se puede realizar desde el menú SETUP → [Sistema] → [Configuración Sencilla] (pág. 31).

- 1 Cuando se muestre la pantalla Configuración Sencilla, pulse **ENTER** para iniciar Configuración Sencilla.



- 2 Pulse ▲/▼ para seleccionar el idioma que desea ver en la pantalla y, después, pulse **ENTER**.

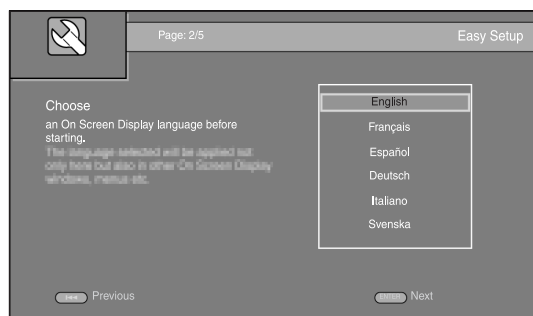

- 3 Pulse ▲/▼ para seleccionar la resolución y, a continuación, pulse **ENTER**. Para obtener más información sobre la configuración de las opciones, consulte “[Seleccionar Salida de Vídeo]” (pág. 36).

Nota

Si conecta el televisor y esta unidad a través de la toma VIDEO, seleccione [Compuesta].

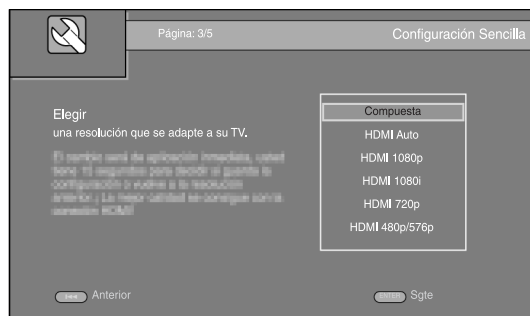

- 4 Pulse ▲/▼ para seleccionar la relación de aspecto de pantalla y, a continuación, pulse **ENTER**. Para obtener más información sobre la configuración de las opciones, consulte “[Pantalla de TV]” (pág. 36). La Configuración Sencilla habrá finalizado.

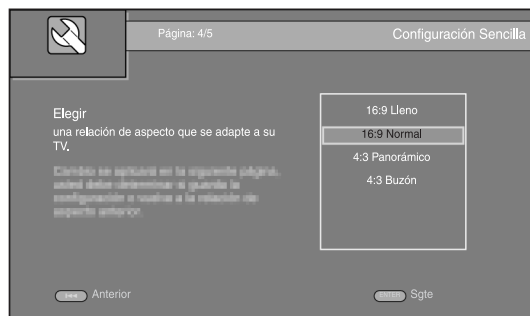

- 5 Pulse **ENTER** para salir de Configuración Sencilla.

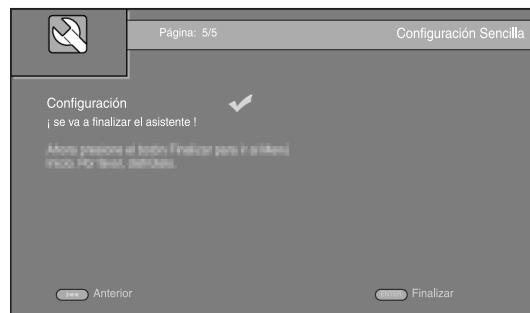

Notas







- Si no se muestra la imagen tras completar Asistente inicial/Configuración Sencilla, consulte “SOLUCIÓN DE PROBLEMAS” (pág. 41).
- Aparecerá un mensaje de advertencia acerca de la reproducción de vídeo en 3D cuando esta unidad esté encendida. Pulse **ENTER** para descartar el mensaje o **CLEAR** para desactivarlo (pág. 34).

FUNCIONAMIENTO BÁSICO

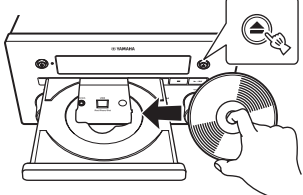
☀️
Si la fuente es CD/iPod/FM/TV, consulte “Funcionamiento básico sin el menú HOME/MEDIA” (pág. 19). Si la fuente es BD/DVD/USB/Red, lea el apartado siguiente (también es posible reproducir un CD con el menú HOME/MEDIA).

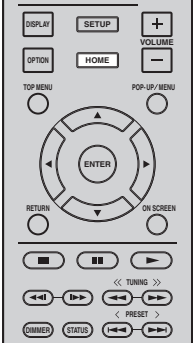
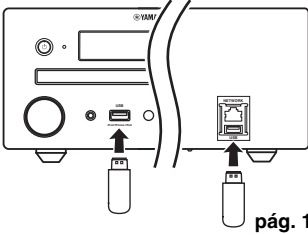
Funcionamiento básico con el menú HOME/MEDIA

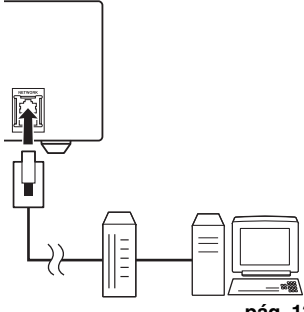
Siga los procedimientos que se indican a continuación para reproducir la fuente.

	1 Ajustar la fuente	2 Cambiar la entrada	3 Consulte las siguientes páginas para obtener información sobre más operaciones
Disco	 <p>pág. 16</p>		
USB*1	<p>Delante Detrás</p>  <p>pág. 13, 16</p>		
Red (Contenidos de PC y YouTube*2)	 <p>pág. 13, 18</p>		

- *1 • Es posible que algunos dispositivos no funcionen correctamente aunque cumplan con los requisitos.
- No se garantizan la reproducción y alimentación de todos los tipos de dispositivos USB.
- El tiempo de lectura puede superar los 30 segundos en función del número de archivos/carpetas.
- Yamaha y los distribuidores no se harán responsables de las pérdidas de datos almacenados en dispositivos USB conectados a esta unidad.
Como medida de precaución, se recomienda realizar copias de seguridad de los archivos.
- *2 Disponible solo en modelos de Asia y América Central y del Sur.

■ Control del nivel de volumen

- 1 Pulse los **botones de control del volumen (+/-)** en el mando a distancia para subir/bajar el nivel de volumen (pág. 7).

■ Activar/desactivar el modo de reproducción envolvente

- 1 Pulse **SURROUND** para activar o desactivar el modo de reproducción envolvente (pág. 7).

Si está activado:

- Se reproducen sonidos envolventes gracias a la tecnología AIR SURROUND XTREME exclusiva de Yamaha (pág. 48) si la fuente es una fuente de reproducción envolvente, como por ejemplo BD.
- Se reproducen sonidos estéreo más anchos si la fuente es una fuente de reproducción estéreo, como un CD de audio.

Reproducción de Foto/Música/Vídeo

Los menús HOME y MEDIA le permiten examinar y reproducir archivos multimedia en discos de datos, dispositivos de memoria USB y su red.

Nota

Para obtener información sobre los discos y archivos que se pueden reproducir, consulte la página 3.

■ Funcionamiento básico

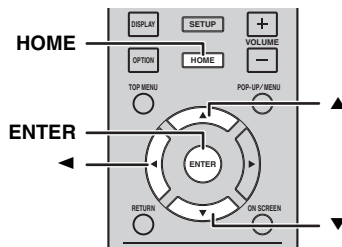

▲/▼: mueve la selección.

◀: vuelve a la carpeta principal.

HOME: permite entrar/salir de la pantalla de menú HOME.

ENTER: confirma la carpeta/archivo.

■ Iconos sobre el menú MEDIA

: reproduce el disco que hay en la bandeja o muestra el contenido del disco de datos.

: muestra el contenido del dispositivo de memoria USB conectado al puerto USB.

: busca un servidor DLNA (pág. 18) en la red.

: muestra el contenido del servidor DLNA conectado.

■ Operaciones comunes para la reproducción de archivos en una carpeta seleccionada

Ejemplo: selección de un archivo de película en un dispositivo de memoria USB

Nota

Detenga la reproducción del vídeo antes de desplazarse a la pantalla de menú MEDIA.

- 1 Pulse **HOME** para pasar a la pantalla de menú HOME.

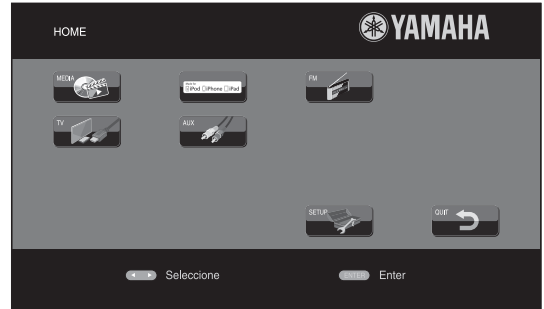

La pantalla de menú HOME puede variar en función del modelo.

- 2 Pulse ◀/▶/▲ para seleccionar [MEDIA] y, a continuación pulse **ENTER**. Aparece la pantalla MEDIA.

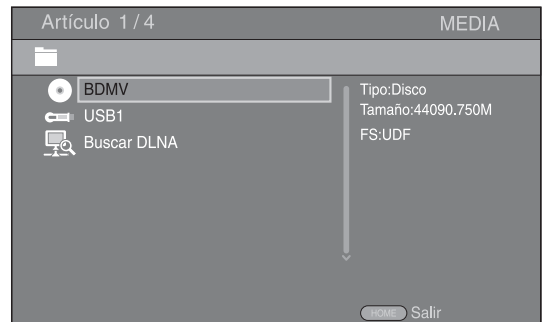

- 3 Seleccione el elemento que contiene el archivo que desea reproducir y, a continuación, pulse **ENTER**.

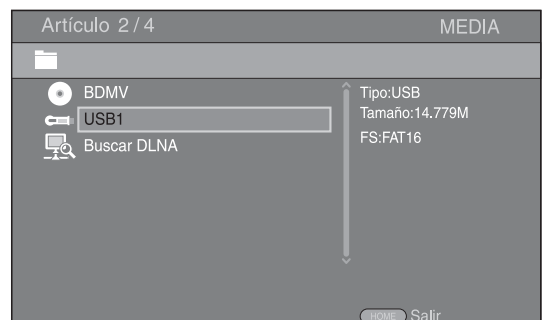

- 4** Seleccione la carpeta de Foto, Música, Vídeo o AVCHD que desea reproducir y, a continuación, pulse **ENTER**.
Para volver a la carpeta principal, pulse **◀** o seleccione **↑**.

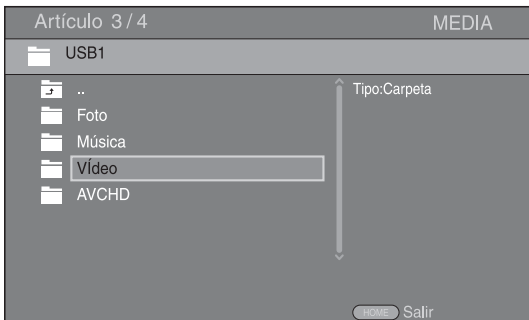

Nota

Tenga en cuenta que en el siguiente paso solo se mostrarán los archivos del tipo que seleccione en este paso. Por ejemplo, si selecciona la carpeta Foto en este paso, solo se mostrarán archivos de fotos después de este paso. Si desea reproducir un tipo de archivo distinto a foto, vuelva a este paso y seleccione de nuevo el tipo de archivo.

- 5** Seleccione las carpetas que contienen el archivo que desea reproducir.

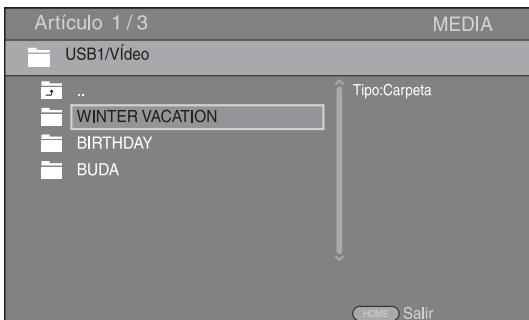

- 6** Seleccione el archivo que desea reproducir y, a continuación, pulse **ENTER**.
Cuando se selecciona un archivo de vídeo se inicia la reproducción.
Cuando se selecciona un archivo de música, se muestra la pantalla de estado y se inicia la reproducción.
Cuando se selecciona un archivo de fotografía se inicia el pase de diapositivas.

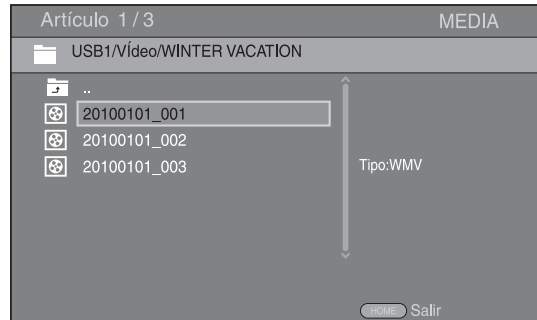

Para disfrutar del pase de diapositivas con música, pulse **HOME** para volver a la pantalla de menú HOME mientras se reproduce la música y seleccione archivo de fotos.

Nota

Es posible que el archivo mostrado no se reproduzca dependiendo del contenido.

Operaciones para visualización de fotos

Mientras se ven fotos, los botones del mando a distancia funcionan como se indica a continuación.

- : detiene un pase de diapositivas y vuelve al explorador de archivos.
- ■ : sitúa en pausa un pase de diapositivas.
- ▶ : reproduce un pase de diapositivas.
- ▶▶ : pasa a la fotografía siguiente.
- ◀◀ : pasa a la fotografía anterior.
- ▶▶▶ : acelera un pase de diapositivas en 3 pasos.
- ◀◀◀ : ralentiza un pase de diapositivas en 3 pasos.
- ▲ : invierte una foto.
- ▼ : muestra la foto reflejada.
- ◀ : gira una foto en sentido contrario a las agujas del reloj.
- ▶ : gira una foto en el sentido de las agujas del reloj.
- ZOOM:** amplía/reduce una foto (ampliar/reducir zoom: 3 pasos cada uno).
 - ▲/▼/◀/▶ : permite desplazarse en modo de zoom cuando la foto es mayor que la pantalla.
- DIGEST:** cambia a modo de miniaturas (pág. 7). Cuando se muestran las miniaturas, puede ir a la página siguiente o anterior con ◀◀◀/▶▶▶.

Uso del contenido de red

■ Acerca de DLNA

Esta unidad es un reproductor multimedia digital certificado para DLNA. Puede administrar contenido de fotos, música y vídeo almacenado en servidores DLNA en su red doméstica.

DLNA (Digital Living Network Alliance) permite compartir de forma sencilla medios digitales a través de una red doméstica y puede disfrutar del contenido digital almacenado en su software, PC instalado, servidor DLNA u otro dispositivo compatible con DLNA con su televisor a través de esta unidad. Para conectar esta unidad a sus servidores DLNA se requieren algunos ajustes del dispositivo o del servidor DLNA. Para obtener más información, consulte el software del servidor DLNA o el dispositivo DLNA.

■ Reproducción de contenido compartido

Nota

Para reproducir archivos en el PC, instale un software de servidor DLNA, como por ejemplo Windows Media Player 12, y comparta los archivos que desee reproducir.

1 Encienda el PC con el software de servidor DLNA instalado o el dispositivo DLNA conectado a su red doméstica.

2 Pulse **HOME** para mostrar la pantalla del menú HOME y, seguidamente, seleccione [MEDIA] para ir al menú MEDIA.
Los servidores DLNA conectados a la red aparecen en pantalla.

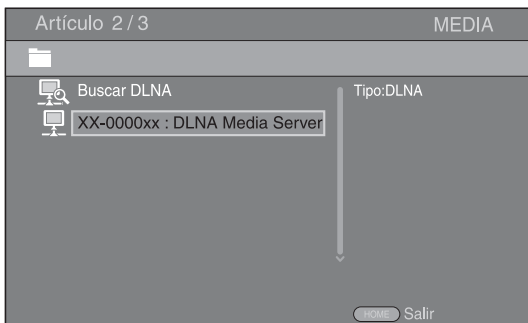

Notas

- Si su servidor DLNA no aparece en la lista, seleccione [Buscar DLNA] para buscarlo.
- Dependiendo del servidor DLNA, es posible que sea necesario autorizar la unidad desde el servidor.
- Para reproducir el archivo en el servidor DLNA, la unidad y el servidor deben estar conectados al mismo punto de acceso.
- Es posible que los requisitos de archivo no siempre sean compatibles. Podría haber algunas restricciones dependiendo de las características de los archivos y de la capacidad del servidor DLNA.

3 Seleccione el archivo que desee reproducir.

Notas

- La calidad de funcionamiento y reproducción podría verse afectada por las condiciones de la red doméstica.
- Es posible que los archivos de medios extraíbles, como dispositivos de memoria USB o unidades de DVD del servidor de medios, no se compartan correctamente.

Reproducción de vídeos desde YouTube™ (Solo modelos de Asia y América Central y del Sur)

Puede ver películas desde YouTube a través de Internet mediante esta unidad.

Los servicios pueden modificarse sin previo aviso.

1 Pulse **HOME** para mostrar la pantalla del menú HOME.

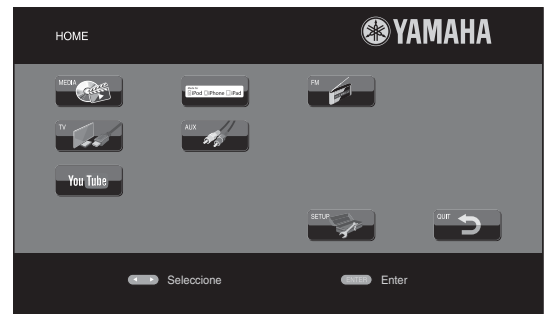

La pantalla de menú HOME puede variar en función del modelo.

2 Pulse **▲/▼/◀/▶** para seleccionar [YouTube] y, a continuación, pulse **ENTER**.









Para volver a la pantalla de menú HOME, pulse **RETURN**.

■ Avisos sobre los servicios de red

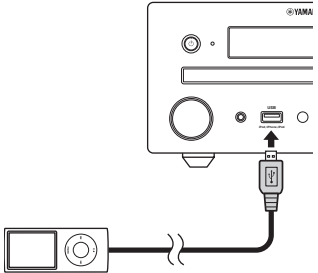
- El acceso a contenido suministrado por terceros requiere una conexión a Internet de alta velocidad y también un registro de cuenta y una suscripción de pago.
- Los servicios de contenido de terceros pueden modificarse, suspenderse, interrumpirse o dejar de proporcionarse en cualquier momento sin previo aviso, y Yamaha no asume ninguna responsabilidad en relación con dichos sucesos.
- Es posible que parte del contenido solo esté disponible para países específicos y que se presente en idiomas específicos.
- Yamaha no manifiesta ni garantiza que los servicios de contenido se seguirán proporcionando o estarán disponibles durante un periodo de tiempo concreto, y declina ofrecer cualquier garantía de este tipo, ya sea expresa o implícita.

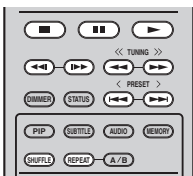
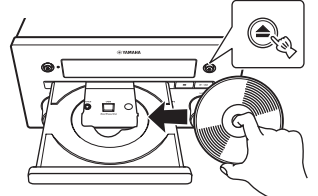
Funcionamiento básico sin el menú HOME/MEDIA

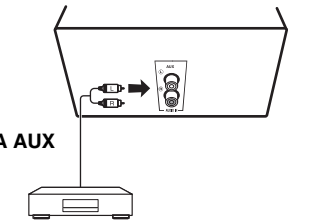
Siga los procedimientos que se indican a continuación para reproducir la fuente.

	1 Ajustar la fuente	2 Cambiar la entrada	3 Seleccionar la música e iniciar la reproducción
iPod*1	 <p>pág. 11, 20</p>		
CD	 <p>pág. 20</p>		
AUX	 <p>A AUX</p>		<p>Para obtener más información sobre el funcionamiento, consulte el manual de instrucciones suministrado con el dispositivo conectado, como un reproductor MD.</p>
FM	Para sintonizar emisoras de radio FM, consulte página 26.		
Televisor	Para emitir sonidos de TV, consulte la página 12, en relación con las conexiones y la selección de la fuente de entrada a TV (pág. 7)		

*1 · Es posible que algunas funciones no estén disponibles en función del modelo o de la versión del software de su iPod.

· Al reproducir un iPod, se activa la función Music Enhancer, que potencia el sonido de la música comprimida regenerando los elementos musicales perdidos en el proceso de compresión. (Disponible solo para iPod.)

■ Control del nivel de volumen

- 1 Pulse los **botones de control del volumen (+/-)** en el mando a distancia para subir/bajar el nivel de volumen (pág. 7).

■ Activar/desactivar el modo de reproducción envolvente

- 1 Pulse **SURROUND** para activar o desactivar el modo de reproducción envolvente (pág. 7).

Si está activado:

- Se reproducen sonidos envolventes gracias a la tecnología AIR SURROUND XTREME exclusiva de Yamaha (pág. 48) si la fuente es una fuente de reproducción envolvente, como por ejemplo BD.
- Se reproducen sonidos estéreo más anchos si la fuente es una fuente de reproducción estéreo, como un CD de audio.

Funcionamiento para iPod

Puede controlar la reproducción de un iPod a través de los botones del mando a distancia.

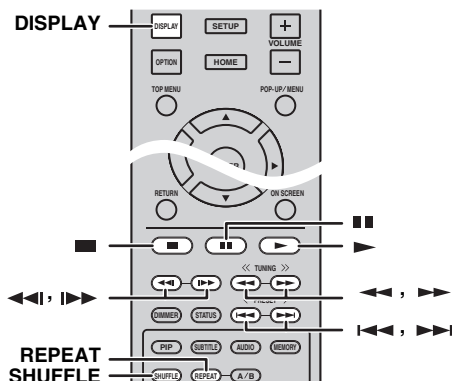

Nota

Es posible que algunas funciones no sean compatibles dependiendo del modelo o de la versión del software de su iPod.

■ Controles de la reproducción

1 Pulse cualquiera de los botones siguientes durante la reproducción.

- : detiene la reproducción.
- ■ : sitúa la reproducción en pausa.
- ▶▶ : saltar hacia adelante.
- ◀◀ : saltar hacia atrás.

Para iniciar o reanudar la reproducción, pulse ▶.



Pulse **DISPLAY** para mostrar la siguiente información en el visor del panel delantero durante la reproducción.

- Nombre de canción
- Nombre de artista
- Nombre de álbum

Nota

Hay algunos caracteres que no se pueden visualizar en el visor del panel delantero de esta unidad.

■ Reproducción aleatoria

Es posible reproducir en una secuencia aleatoria.

1 Pulse varias veces **SHUFFLE** para la reproducción aleatoria.
Con cada pulsación se avanza en la siguiente secuencia:

SHUFFLE SONGS → (SHUFFLE ALBUMS)*1 → SHUFFLE OFF

*1 No es posible ajustar ALBUMS si se utiliza un iPod touch, iPhone o iPad.

■ Repetición de reproducción

Puede repetir la reproducción como desee.

1 Pulse varias veces **REPEAT** para la repetición de reproducción.
Con cada pulsación se avanza en la siguiente secuencia:

REPEAT ONE → REPEAT ALL → REPEAT OFF

Operaciones con un CD

También puede controlar la reproducción de los CD.

■ Controles de la reproducción

1 Pulse cualquiera de los botones siguientes durante la reproducción.

- : detiene la reproducción.
 - ■ : sitúa la reproducción en pausa.
 - ▶▶ : saltar hacia adelante.
 - ◀◀ : saltar hacia atrás.
 - ▶▶ : buscar hacia adelante.
 - ◀◀ : buscar hacia atrás.
 - ▶▶ : púlselo para realizar una búsqueda instantánea. La búsqueda instantánea salta 30 segundos en la música.
 - ◀◀ : púlselo para realizar una repetición instantánea. La repetición instantánea reproduce la música desde 10 segundos antes.
- Para iniciar o reanudar la reproducción, pulse ▶.



También puede usar los **botones numéricos** para introducir directamente el número de la canción. Para borrar la entrada, pulse **CLEAR**.

■ Reproducción aleatoria

Es posible reproducir en una secuencia aleatoria.

1 Pulse varias veces **SHUFFLE** para la reproducción aleatoria.
Con cada pulsación se cambia en la siguiente secuencia:

SHUFFLE → NORMAL

■ Repetición de reproducción

Puede repetir la reproducción como desee.

1 Pulse varias veces **REPEAT** para la repetición de reproducción.
Con cada pulsación se avanza en la siguiente secuencia:

REPEAT ONE → REPEAT ALL → REPEAT OFF

FUNCIONAMIENTO DE REPRODUCCIÓN AVANZADO

En este capítulo se explica la reproducción de discos BD/DVD/CD comercializados en tiendas y discos DVD-RW/R grabados.

Nota

Para conocer el funcionamiento básico de reproducción, consulte la página 6.

Menú en pantalla

Para mostrar el menú en pantalla, pulse **ON SCREEN**. A continuación, pulse **▲/▼/◀/▶** para seleccionar un elemento, después pulse **ENTER** para utilizar la función deseada.

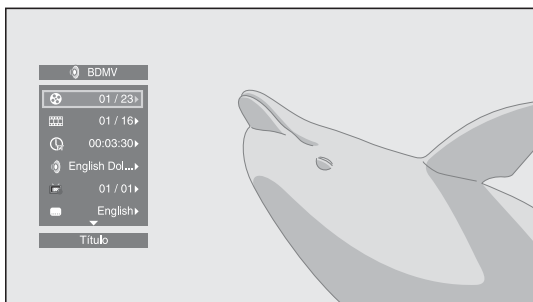

El menú en pantalla consta de los siguientes elementos.

Título **BD** **DVD** **VIDEO**: muestra el número del título que se está reproduciendo. Puede saltar al título deseado seleccionándolo desde este elemento.

Capítulo **BD** **DVD** **VIDEO**: muestra el número del capítulo que se está reproduciendo. Puede saltar al capítulo deseado seleccionándolo desde este elemento.

Pista/Archivo **CD** **VIDEO** **MUSIC** **PHOTO**: muestra el número de la pista o archivo que se está reproduciendo. Puede saltar a la pista o al archivo deseado seleccionándolo desde este elemento.

Hora **BD** **DVD** **CD** **VIDEO** **MUSIC**: muestra el tiempo de reproducción. Seleccione el tipo de visualización entre los siguientes:

- Tiempo de reproducción transcurrido del título, capítulo, disco, pista o archivo.
- Tiempo de reproducción restante del título, capítulo, disco, pista o archivo.

Modo/Modo de reproducción

DVD **CD** **VIDEO** **MUSIC** **PHOTO**: muestra el modo de reproducción actual. Puede seleccionar uno de los modos de reproducción siguientes:

CD

- Normal: reproducción normal.
- Shuffle: reproducción aleatoria sin repetición.
- Aleatorio: reproducción aleatoria con repetición.

DVD

- Normal
- Shuffle CH (capítulo)
- Shuffle TT (título)
- Shuffle All
- Aleatorio CH (capítulo)
- Aleatorio TT (título)
- Aleatorio All



VIDEO MUSIC PHOTO

- Normal
- Shuffle F (carpeta)
- Aleatorio F (carpeta)

Audio **BD** **DVD** **VIDEO**: muestra el idioma/señal de audio del disco BD/DVD seleccionado actualmente. Puede seleccionar el tipo de audio deseado.

Ángulo **BD** **DVD**: muestra el número del ángulo seleccionado actualmente. Si el vídeo se ha grabado con varios ángulos, puede cambiar el ángulo.



Cuando Marca de Ángulo () está ajustado en [Activar] (pág. 35),  se muestra en pantalla cuando la función está disponible.

Subtítulo **BD** **DVD** **VIDEO**: muestra el idioma de los subtítulos seleccionados actualmente si hay subtítulos.

Estilo subtítulos **BD**: muestra el estilo de los subtítulos seleccionados actualmente. Esta función solo está disponible para subtítulos externos de archivo de vídeo. Puede seleccionar el estilo de texto deseado de los subtítulos.

Bitrate **BD** **DVD** **CD** **VIDEO** **MUSIC**: muestra la velocidad de bits de la señal de audio/vídeo.

Video secundario **BD**: activa o desactiva PIP (pág. 6).

Audio secundario **BD**: activa o desactiva el audio secundario.

Búsqueda Ins

BD **DVD** **CD** **VIDEO** **MUSIC**: salta 30 segundos.

Repetición Ins

BD **DVD** **CD** **VIDEO** **MUSIC**: reproduce el contenido desde 10 segundos antes.

Pase de diapositivas **PHOTO**: muestra la velocidad del pase de diapositivas. Puede seleccionar la velocidad del pase de diapositivas entre Lento/Medio/Rápido.

Transición **PHOTO**: muestra cómo aparece la foto en la pantalla. Puede seleccionar el tipo de transición.

Menú de estado

Muestra varios ajustes, cómo los subtítulos, el ángulo y el número de título/capítulo/pista reproducido actualmente. Para mostrar el menú de estado, pulse **STATUS**. El menú de estado consta de los siguientes menús.

BD DVD VIDEO

Ejemplo: iconos cuando se reproduce un disco BD

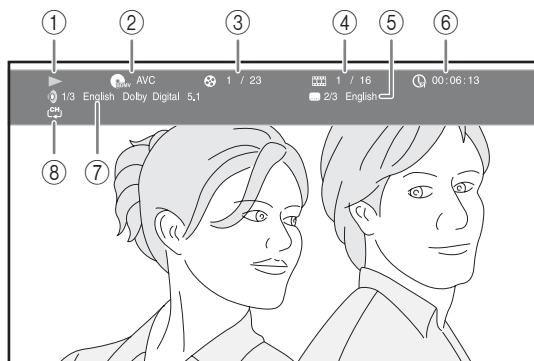

- ① ▶ (Estado de reproducción)
- ② (Icono de tipo de disco/archivo de vídeo)
- ③ (Número de título que se reproduce): puede saltar al título especificado con la tecla **SEARCH** (pág. 7).
- ④ (Número de capítulo que se reproduce): puede saltar al capítulo especificado con la tecla **SEARCH** (pág. 7).
- ⑤ (Subtítulos seleccionados actualmente): puede cambiar el idioma de los subtítulos con la tecla **SUBTITLE** (pág. 6).
- ⑥ (Tiempo de reproducción transcurrido): puede saltar al punto especificado con la tecla **SEARCH** (pág. 7).
- ⑦ (Audio seleccionado actualmente): puede cambiar el formato o idioma de audio con la tecla **AUDIO** (pág. 7).
- ⑧ (Modo repetición): muestra el modo de repetición actual (pág. 6).

CD MUSIC

Ejemplo: iconos cuando se reproduce un archivo de música

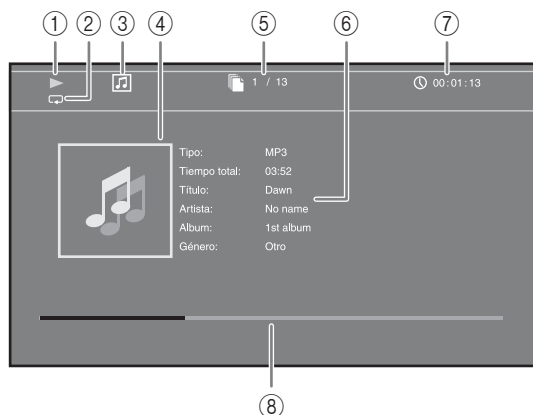

- ① ▶ (Estado de reproducción)
- ② (Modo repetición): muestra el modo de repetición actual (pág. 6).
- ③ (Icono de tipo de disco/archivo de música)
- ④ (Gráficos) **MUSIC**: muestra gráficos, si hay en el archivo.
- ⑤ (Número de pista/archivo que se reproduce): puede saltar a la pista especificada con la tecla **SEARCH** (pág. 7).
- ⑥ (Información) **MUSIC**: muestra información musical, si hay en el archivo.
- ⑦ (Tiempo de reproducción transcurrido): puede saltar al punto especificado con la tecla **SEARCH** (pág. 7).
- ⑧ (Barra de progreso) **MUSIC**: muestra el estado de progreso de la canción actual.

PHOTO

Ejemplo: iconos cuando se visualiza un archivo de fotografía



- ① ▶ (Estado de reproducción)
- ② (Icono de archivo de fotos)
- ③ (Número de archivo que se muestra)
- ④ (Modo repetición): muestra el modo de repetición actual (pág. 6).
- ⑤ (Velocidad de pase de diapositivas)

Uso de Marcador

Le permite establecer un Marcador en un punto especificado del vídeo. Después de establecer el Marcador, puede saltar al punto utilizando esta función. Puede definir hasta 12 marcadores.

DVD VIDEO

Ejemplo: establecer un Marcador al reproducir una película.

- 1 Pulse **MARKER** durante la reproducción de la película para definir el Marcador. Se muestran el número de Marcador y el estado.

Marcador: 1/12 Título: 1 Capítulo: 1 Hora: 00:01:26

- 2 Después de establecer el Marcador, pulse **DIGEST** para mostrar la barra de selección de Marcador.

Título:01 Capítulo:01 Hora: 00:01:26 Marcador
 01 02 03 04 05 06 07 08 09 10 11 12 **Claro**

- 3 Pulse **◀/▶** para seleccionar el Marcador que desea reproducir y, a continuación, pulse **ENTER**. Pulse **CLEAR** para borrar el Marcador seleccionado.

Nota

Cuando finaliza la reproducción (por ejemplo, al expulsar el disco o al presionar **■** dos veces), los marcadores se eliminan automáticamente.

Reproducción de programa

Esta opción le permite programar el orden de reproducción de las pistas de un disco de audio o de los capítulos de DVD. Puede programar hasta 15 pistas/capítulos.

DVD CD

Ejemplo: programación del orden de reproducción de pistas de CD

- 1 Pulse **PROGRAM** durante la reproducción para ver la pantalla PROGRAMA.

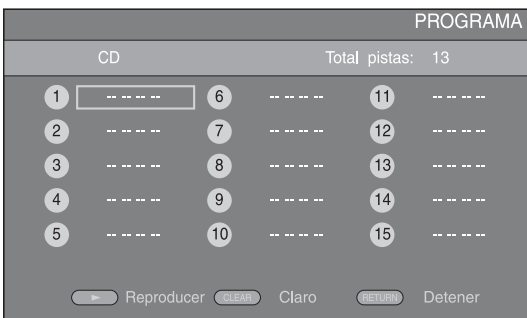

- 2 Pulse **ENTER** para programar el orden de reproducción. Para un disco de audio, pulse **▲/▼** para seleccionar una pista deseada y, a continuación, pulse **ENTER**. Para un disco DVD-Vídeo, seleccione un título deseado (mostrado como TT) y capítulo (mostrado como CH) en lugar de una pista. Para borrar una pista establecida, seleccione la pista que desea borrar y, a continuación, pulse **CLEAR**. Pulse **RETURN** para cancelar la reproducción del programa.



- 3 Una vez finalizada la programación, pulse **▶** para definir e iniciar la reproducción del programa.
- 4 Para cancelar la reproducción del programa, detenga la reproducción por completo pulsando **■** dos veces.

Uso de la búsqueda

Esta opción le permite saltar a un punto específico durante la reproducción.





BD DVD CD VIDEO MUSIC

Ejemplo: buscar hasta el punto especificado



1 Pulse **SEARCH** durante la reproducción. Aparece la barra de estado.

2 Pulse **▲/▼/◀/▶** para seleccionar uno de los elementos siguientes y, a continuación, pulse **ENTER**.



BD DVD :

- Número de título (mostrado como )
- Número de capítulo (mostrado como )
- Tiempo de título transcurrido (mostrado como )
- Tiempo de capítulo transcurrido (mostrado como )

CD :

- Número de pista (mostrado como )
- Tiempo de pista transcurrido (mostrado como  TRACK)
- Tiempo de disco transcurrido (mostrado como  DISC)

VIDEO MUSIC :

- Número de archivo (mostrado como )
- Tiempo de archivo transcurrido (mostrado como )

3 Pulse **▲/▼** o las teclas de número para definir o ajustar el valor del elemento seleccionado y pulse **ENTER** para saltar al punto especificado.

4 Para cerrar la barra de estado, pulse **STATUS**.

Disfrutar de BONUSVIEW™ y BD-Live™

Esta unidad admite las funciones de reproducción de BONUSVIEW (pág. 48) (BD-ROM Perfil 1 Versión 1.1) y BD-Live (pág. 48) (BD-ROM Perfil 2).



Nota

Las funciones y el método de reproducción varían según el disco. Siga las indicaciones del disco o del manual de usuario suministrado.

■ Utilización de la función Imagen en Imagen (reproducción de audio/vídeo secundario)

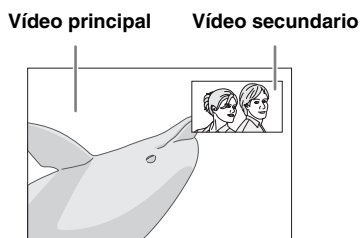
Un Vídeo BD con audio y vídeo secundario compatible con Imagen en Imagen se puede reproducir con audio y vídeo secundario simultáneamente como un vídeo pequeño en la esquina.



1 Mientras se muestra Marca PIP () o Marca Audio Secundario () , pulse **PIP** para activar o desactivar la función Imagen en imagen.

Notas

- Para escuchar audio secundario de un televisor conectado con un cable HDMI, asegúrese de que la salida de audio (HDMI) está ajustada en [PCM] (pág. 38).
- Dependiendo del disco, para escuchar audio secundario es posible que tenga que activar el audio secundario en el menú principal del disco (pág. 8).
- Dependiendo del contenido, el audio y el vídeo secundario para Imagen en Imagen podría reproducirse y desaparecer automáticamente. Además, podrían existir restricciones respecto a las áreas que pueden reproducirse.

■ Utilización de la función BD-Live™

- 1 Ajuste la configuración de Red (pág. 35).
- 2 Conecte el dispositivo de memoria USB a la unidad (pág. 13).
 - Los datos BD-Live se guardan en un dispositivo de memoria USB conectado a esta unidad.
 - Conecte un dispositivo de memoria USB (2 GB o superior y formateado con FAT 32/16) compatible con USB 2.0 de alta velocidad (480 Mbit/s) al puerto USB seleccionado en Almacenamiento Local (pág. 34). La configuración predeterminada es el puerto USB del panel trasero.
 - La carpeta “BUDA” se crea automáticamente en el dispositivo de memoria USB, si es necesario.
 - Si el espacio de almacenamiento es insuficiente, los datos no se copiarán/descargarán. Elimine datos innecesarios o utilice un nuevo dispositivo de memoria USB.
 - Puede que sea necesario algún tiempo para que se carguen (lectura/escritura) los datos.
- 3 Reproducción del disco.
- 4 Ejecute BD-Live siguiendo las instrucciones del disco.

Notas

- En relación con el método de reproducción de contenidos BD-Live, etc., lleve a cabo las operaciones de acuerdo con las instrucciones del manual del disco BD.
- Para disfrutar de las funciones de BD-Live, realice la conexión de red (pág. 13) y los ajustes de Red (pág. 35).
- Consulte “[Conexión BD-Live]” (pág. 35) en relación con la configuración para restringir el acceso a contenidos BD-Live.
- El tiempo que se necesita para descargar los programas que se ofrecen al dispositivo de memoria USB conectado en esta unidad depende de las velocidades de conexión a Internet y del volumen de datos de los programas.
- Los programas BD-Live suministrados a través de Internet podrían no ser capaces de mostrar la conexión, en función del estado (actualización) del proveedor. En tal caso, extraiga el disco y vuelva a intentarlo.
- Si la pantalla BD-Live no aparece durante un rato después de seleccionar la función BD-Live en el menú del disco BD, es posible que el dispositivo de memoria USB no tenga suficiente espacio libre. En tal caso, expulse el disco de la unidad y, a continuación, borre los datos del dispositivo de memoria USB seleccionando [Formato] en [Almacenamiento Local] (pág. 34).

ESCUCHAR EMISORAS DE RADIO FM

Sintonización de emisoras de radio

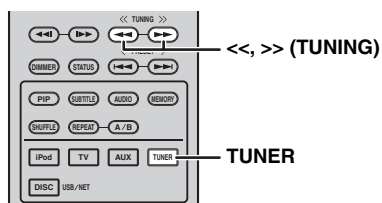

1 Pulse **TUNER**.

2 Mantener pulsado << / >> (**TUNING**).
Comenzará el proceso de sintonización automática.



Si la señal recibida de la emisora que desea seleccionar es débil, también es posible sintonizar emisoras de radio de forma manual pulsando << / >> (**TUNING**) varias veces. En este caso, el sonido será monoaural.

Preajuste de emisoras de radio

Es posible almacenar sus emisoras FM favoritas con la función de presintonía.

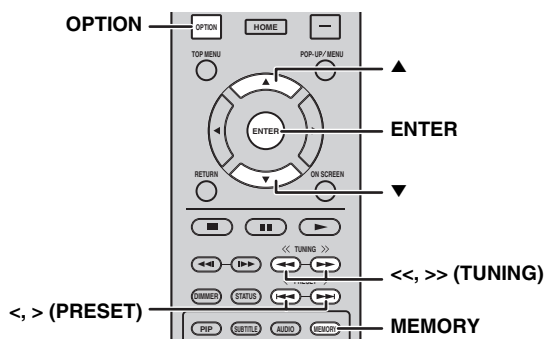

Presintonización automática

1 Mantenga pulsado el botón **MEMORY** durante más de 3 segundos en el modo FM.

2 Pulse **ENTER**.
Comenzará la presintonización automática.

Nota

Al realizar la presintonización automática, se borran todas las emisoras almacenadas y se almacenan emisoras nuevas.

Presintonización manual

1 Seleccione una emisora de radio que le guste pulsando << / >> (**TUNING**).

2 Pulse **MEMORY**.

3 Seleccione el número de presintonía en la que desea guardarla pulsando ▲ / ▼ o < / > (**PRESET**).

4 Pulse **ENTER**.
El proceso de presintonización manual ha terminado.



- Es posible presintonizar un máximo de 30 emisoras FM.
- Para cancelar la presintonización manual mientras escoge un número de presintonía, pulse **MEMORY** de nuevo.
- Es posible eliminar una emisora presintonizada pulsando **OPTION** → ▲ / ▼ → **ENTER** para seleccionar [PRESET DEL] (pág. 27).

Selección de emisoras de radio presintonizadas (Sintonización de presintonías)

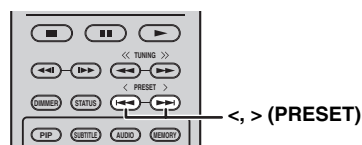

1 Seleccione la emisora de radio presintonizada en el modo FM pulsando < / > (**PRESET**).



Puede utilizar también los **botones numéricos** del mando distancia o < / > (**PRESET**) en el panel delantero de esta unidad para seleccionar la emisora de radio presintonizada.

UTILIZACIÓN DE FUNCIONES ÚTILES

Utilización del menú de opciones del visor del panel delantero

El menú de opciones aparece en el visor del panel delantero al pulsar **OPTION**. Desde el menú de opciones puede ajustar diversas funciones útiles.

Menú de opciones	Parámetro o rango de control	Página de referencia
PRESET DEL	(Aparece únicamente cuando la fuente de entrada está ajustada en FM.)	26
TREBLE	-10 dB a +10 dB	a continuación
BASS	-10 dB a +10 dB	a continuación
BALANCE	L+5 - CENTER - R+5	a continuación
BASS BOOST	ON/OFF	a continuación

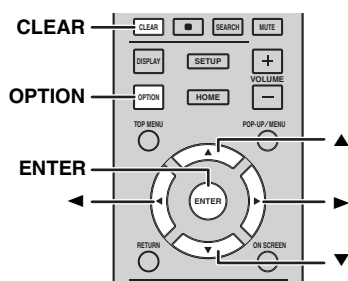

■ Ajuste del tono/balance

[TREBLE]*2: ajusta la respuesta de alta frecuencia.

[BASS]*2: ajusta la respuesta de baja frecuencia.

[BALANCE]: ajusta el nivel del sonido de cada canal de altavoz derecho e izquierdo.

[BASS BOOST]: aumenta la respuesta de baja frecuencia cuando está ajustado en la posición [ON].

*2 Activo también mientras utiliza los auriculares.

- 1 Pulse **OPTION**.
- 2 Seleccione el menú de opciones deseado pulsando ▲/▼.
- 3 Pulse **ENTER** para confirmar.
- 4 Modifique los ajustes pulsando ▲(▶)/▼(◀).
- 5 Pulse **ENTER** para guardar el ajuste.*1
- 6 Pulse **OPTION** para salir del menú de opciones.

*1 Para configurar otras opciones, repita los pasos del 2 al 5.

Ajuste del reloj/temporizador y del temporizador de apagado

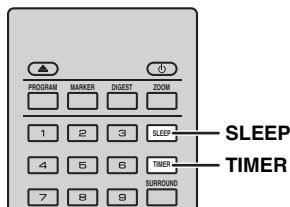

■ Configuración del reloj

Puede ajustar el reloj directamente con el mando a distancia. El reloj aparece en el visor del panel delantero.

- 1 Pulse **TIMER**.
- 2 Pulse **ENTER**.
- 3 Ajuste la hora y los minutos pulsando ▲/▼. Pulse ◀/▶ para pasar del ajuste de las horas a los minutos.
- 4 Pulse **ENTER** para guardar el ajuste.



Al ajustar el reloj, puede usar los **botones numéricos** para seleccionar la hora y los minutos. Para confirmar la entrada, pulse **ENTER**. Para borrar la entrada, pulse **CLEAR**.

Nota

Los ajustes de la hora se perderán si desconecta el cable de alimentación de la toma de pared.

■ Ajuste del temporizador

El temporizador permite ajustar la reproducción de una fuente a la hora configurada en esta unidad.

- 1 Pulse **TIMER**.
- 2 Seleccione las opciones de ajuste deseadas (OnTime/Period/Source/Volume) pulsando ▲/▼.
- 3 Pulse **ENTER** para confirmar la opción.

- 4 Modifique los ajustes pulsando ▲/▼ o los **botones numéricos**.
- 5 Pulse **ENTER** para confirmar el ajuste.
- 6 Repita los pasos del 2 al 5 para ajustar todas las opciones.



- Para borrar la entrada, pulse **CLEAR**.
- Los ajustes del temporizador se guardan.

A continuación, explicamos el procedimiento de ajuste del temporizador.

(Reloj)



OnTime (hora/s y minuto/s)

Ajuste la hora deseada de ejecución de la alarma.



Period (tiempo de reproducción)

Si selecciona [---], el tiempo de reproducción no tiene fin.



Ajuste la Source o el número de memorización

Nota

Si la fuente no está ajustada correctamente no se escuchará el sonido del temporizador. Asegúrese de que la fuente esté fijada correctamente.

CD:

Al seleccionar el CD como fuente, esta unidad reanuda la música que estaba escuchando la última vez que lo utilizó.

iPod:

Al seleccionar el iPod como fuente, esta unidad reanuda la música que estaba escuchando la última vez que lo utilizó.

FM:

Ajuste el número de presintonía. Al seleccionar [---], se seleccionará la última emisora FM ajustada.

Volume

El nivel de volumen puede ajustarse entre [1] – [MAX] y [---]*1. Si el temporizador se activa con esta unidad en modo de espera, se aplica el nivel de volumen definido en este punto. Si se activa el temporizador mientras la unidad está encendida, el nivel de volumen no cambia.

*1 Si ajusta el nivel de volumen en [---] y el temporizador se activa con la unidad en modo de espera, el nivel de volumen se aplica en el mismo nivel que la fuente de entrada.

El proceso de ajuste del temporizador ha terminado.

Ajuste el temporizador en la posición [OFF]/[ONCE]/[EVERY] pulsando ◀/▶. Cuando el temporizador está en la posición [ONCE] o [EVERY], se enciende el indicador TIMER en el panel delantero.

Notas

- Deberá ajustar antes el reloj.
- Cuando el temporizador está activado, se enciende el indicador TIMER en el panel delantero. Cuando la unidad está encendida, el indicador TIMER parpadea a medida que se aproxima la hora ajustada.

■ Ajuste del temporizador de apagado

El temporizador de apagado pone esta unidad en modo de espera una vez transcurrido un tiempo especificado.

1 Pulse **SLEEP** varias veces.

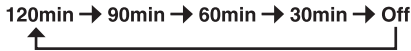

Control de esta unidad con el mando a distancia del televisor (función de control HDMI)

Puede utilizar el mando a distancia del televisor para controlar esta unidad si el televisor es compatible con la función de control HDMI y si está conectado al terminal HDMI de esta unidad.

Mando a distancia de un televisor (ejemplo)

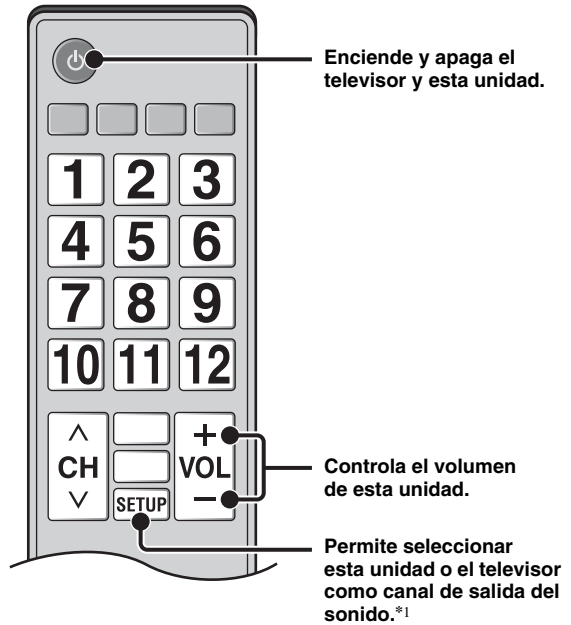

También puede utilizar la siguiente función.

- Al iniciar la reproducción de discos DVD/BD distintos de CD en esta unidad o acceder a la pantalla del menú HOME/SETUP, el selector de entrada del televisor pasa automáticamente a esta unidad (One Touch Play).

*1 Al seleccionar esta unidad como canal de salida del sonido del televisor con el mando a distancia del televisor, la unidad selecciona automáticamente el televisor como fuente de entrada y el sonido puede escucharse a través de los altavoces o los auriculares conectados a la unidad.

Notas

- El televisor debe ser compatible con la tecnología ARC.
- Esta unidad puede controlarse con los botones de cursor del mando a distancia del televisor en algunos televisores.
- Aunque el televisor sea compatible con la función de control HDMI, es posible que algunas funciones no estén disponibles. Para obtener más información, consulte el manual entregado con el televisor.
- Es posible que la función de control HDMI no funcione correctamente dependiendo del televisor.
- Otras funciones, aparte de las que se han mencionado anteriormente, pueden funcionar según el televisor.

Continúa en la página siguiente. ➔

- Para que la función de control HDMI esté disponible, configure los ajustes de la función de control HDMI en **TODOS** los componentes (esta unidad, el televisor y otros componentes). Es posible que también sean necesarias determinadas operaciones.
- Cada función se puede configurar de forma independiente para activar o desactivar según el televisor.
- Consulte los detalles relacionados con la configuración en los manuales de instrucciones entregados con el televisor.

■ Ajuste de la función de control HDMI

1 Encienda todos los componentes conectados al televisor con HDMI.

2 Compruebe todos los componentes conectados con HDMI y active la función de control HDMI en todos los componentes.

En esta unidad, ajuste [Control HDMI] en [Activar] (pág. 34).

En el caso de los componentes externos, consulte el manual entregado con cada componente.



- El ajuste predeterminado de [Control HDMI] es [Desactivar] en esta unidad.
- Ejemplo de configuración de un televisor
 - En el menú de configuración del televisor, seleccione “Ajuste de enlace” → “Ajuste de control HDMI” (ejemplo) y, a continuación, ponga un ajuste como “Función de control HDMI” en la posición “ACTIVADO” (ejemplo).
 - En un ajuste del tipo “Prioridad altavoz” debe seleccionarse una opción como “Amplificador AV”.

3 Apague el televisor y después vuelva a encenderlo.

■ Registro de componentes HDMI en el televisor

1 Seleccione esta unidad como fuente de entrada del televisor.

2 Seleccione Disco/USB/Red como fuente de entrada de esta unidad.

3 Compruebe que la imagen de esta unidad aparezca correctamente en el televisor.

4 Verifique que la función de control HDMI esté activada (encienda esta unidad o ajuste el nivel de volumen con el mando a distancia del televisor).



Con algunos componentes HDMI, basta con ajustar la función de control HDMI. En este caso, no es necesario registrar los componentes HDMI en el televisor.

Si la función de control HDMI no funciona

Realice las siguientes comprobaciones:

- El televisor debe estar conectado al terminal HDMI de esta unidad. La función de control HDMI debe estar ajustada en [Activar] en el menú SETUP (pág. 34).
- La función de control HDMI debe estar activada en el televisor. (Compruebe también los ajustes relativos, como la función de bloqueo de la alimentación o la prioridad del altavoz.)

La función de control HDMI sigue sin funcionar tras realizar las comprobaciones

- Apague esta unidad y el televisor y, después, vuelva a encenderlos.
- Desconecte el cable de alimentación de CA de esta unidad, el televisor y los componentes externos conectados al televisor con HDMI. Espere unos 30 segundos y vuelva a conectarlo.

■ Cambio del método de conexión y los componentes conectados

Cuando cambie los componentes conectados y las tomas, reinicie esta unidad siguiendo los pasos indicados a continuación.



1 Apague la función de control HDMI del televisor y de esta unidad, apague todos los dispositivos conectados y cambie las conexiones.

2 Realice los pasos del 1 al 3 del apartado “Ajuste de la función de control HDMI” (pág. 30).

MENÚ SETUP

El menú SETUP permite realizar diversos ajustes y configuraciones audiovisuales en las funciones utilizando el mando a distancia.

Menú/submenú	Elemento	Función	Página	
 Configuración General	Sistema	Protector de pantalla	Ajusta el protector de pantalla en Activar/Desactivar.	34
	Apagado Automático	Disc/USB/Net: ajusta el modo de apagado automático en Activar/Desactivar. Otras Entradas: ajusta el modo de apagado automático por horas o en Desactivar.	34	
	Reproducción Automática Disco	Ajusta esta unidad para que inicie automáticamente la reproducción del disco.	34	
	Control HDMI	Configura esta unidad para que reciba la señal de control desde el mando a distancia del televisor.	34	
	Cargar configuración por defecto	Restablece todos los ajustes a los valores predeterminados, excepto el ajuste Seguridad.	34	
	Actualizar	Aplica la actualización de esta unidad.	34	
	Configuración Sencilla	Ajusta el idioma, la resolución y la relación de aspecto de la pantalla.	34	
	Almacenamiento Local	Muestra el estado de Almacenamiento Local, formatea Almacenamiento Local y selecciona el puerto USB delantero o posterior de Almacenamiento Local.	34	
	Mensaje Reproducción 3D	Muestra un mensaje de advertencia acerca de la reproducción de vídeo en 3D cuando esta unidad esté encendida.	34	
	Idioma	OSD	Selecciona el idioma del menú en pantalla.	34
	Menú	Permite dar prioridad al idioma del menú del disco.	34	
	Audio	Permite dar prioridad al idioma del audio.	34	
	Subtítulo	Permite dar prioridad al idioma de los subtítulos.	34	
	Reproducción	Subtítulos	Ajusta los subtítulos en Activar/Desactivar.	35
	Marca de Angulo	Permite mostrar la Marca de Angulo cuando se reproduce un disco BD/DVD con varios ángulos.	35	
	Marca PIP	Permite mostrar la Marca PIP cuando se reproduce un disco BD/DVD con Imagen en imagen.	35	
	Marca Audio Secundario	Permite mostrar la Marca Audio Secundario cuando se reproduce un disco BD/DVD con audio secundario.	35	
	Memoria última	Configura esta unidad para que recuerde la posición de la última reproducción de un disco cuando se pone en modo de espera o se abre la bandeja portadiscos.	35	
	Seguridad	Cambiar Contraseña	Permite cambiar la contraseña de Control Paterno y Código de país.	35
	Control Paterno	Establece el Control Paterno en función del contenido del disco.	35	
	Código de país	Establece el Código de país.	35	
	Red	Conexión a Internet	Permite definir la conexión a Internet en Permitir/Desactivar.	35
	Información	Muestra la pantalla de información de red.	35	
	Prueba de conexión	Realiza la prueba de conexión de red.	35	
	Configuración IP	Permite definir la configuración IP en Auto/Manual.	35	
	Conexión BD-Live	Permite definir la conexión a BD-Live en Autorizada/Permitida Parcialmente/Prohibido.	35	
	DLNA	Permite definir la conexión a DLNA en Permitir/Desactivar.	35	
	Configuración Proxy	Permite definir la configuración proxy.	35	

Menú/submenú	Elemento	Función	Página	
 Configuración de pantalla	TV	Salida 3D	Selecciona vídeos en 3D o 2D.	36
		Pantalla de TV	Ajusta la relación de aspecto de la pantalla del televisor conectado y ajusta la salida de vídeo.	36
		Seleccionar Salida de Vídeo	Selecciona la resolución de la salida de vídeo.	36
		Sistema de TV	Permite seleccionar el Sistema de TV entre NTSC/PAL/Multi.	36
		Color Space	Permite seleccionar Color Space entre YCbCr 4:4:4/ YCbCr 4:2:2/Full RGB/RGB.	36
		HDMI Deep Color	Permite seleccionar HDMI Deep Color entre 30 bits/36 bits/Desactivar.	36
		HDMI 1080p 24Hz	Permite definir HDMI 1080p 24Hz en Auto/Desactivar.	37
		Sincronismo de labios	Ajusta el retardo entre vídeo y audio, como por ejemplo cuando el movimiento de la boca no se corresponde con la voz.	37
	Procesamiento de Video	Modo de vídeo	Ajusta la imagen visual.	37
		Ajuste de color	Ajusta Brillo/Saturación/Tonalidad para cada color.	37
		Reducción de ruido	Ajusta el nivel de Reducción de ruido.	37
		Modo desentrelazado	Ajusta la forma de detectar la señal de vídeo.	37
	 Configuración de audio	Salida de audio	HDMI	Permite seleccionar el modo de salida del terminal HDMI entre Bitstream/PCM/Desactivar.
DRC			Define el DRC (Control de gama dinámica).	38
Post-procesamiento		Mezcla ascendente	Convierte la señal de audio de 2 canales en multicanal.	38
 Sistema de Información		Muestra la versión del software y la dirección MAC (pág. 49).	38	

Utilización del menú SETUP

Debe acceder a la pantalla de menú SETUP para realizar los ajustes en esta unidad. A continuación se explican las operaciones básicas del menú SETUP.

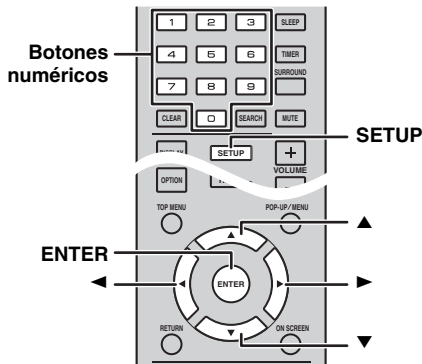

Ejemplo: ajuste de [Control Paterno]

Notas

- Algunas opciones no pueden seleccionarse cuando la fuente de entrada no está ajustada en Disco/USB/Red. En este caso, ajuste la fuente de entrada en Disco/USB/Red.
- Algunos elementos no se pueden ajustar durante la reproducción. En este caso, pulse dos veces **■** para detener la reproducción completamente antes de realizar el ajuste.

- 1 Pulse **SETUP** para mostrar la pantalla del menú SETUP.
Pulse **◀/▶** para seleccionar [Configuración General] y, a continuación, pulse **ENTER** o **▼**.

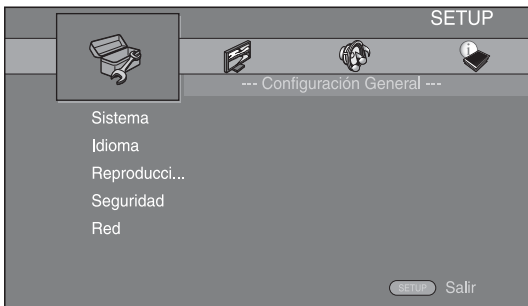

- 2 Seleccione un submenú.
Pulse **▲/▼** para seleccionar [Seguridad] y, a continuación, pulse **ENTER** o el cursor **▶**.

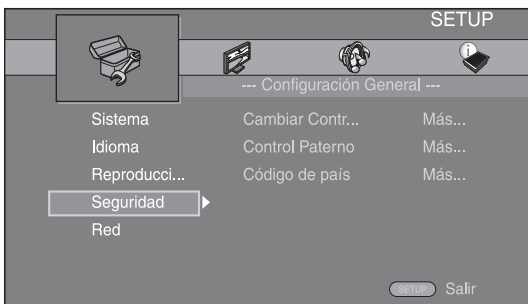

- 3 Seleccione un elemento del menú.
Pulse **▲/▼** para seleccionar [Control Paterno] y, a continuación, pulse **ENTER** o el cursor **▶**.

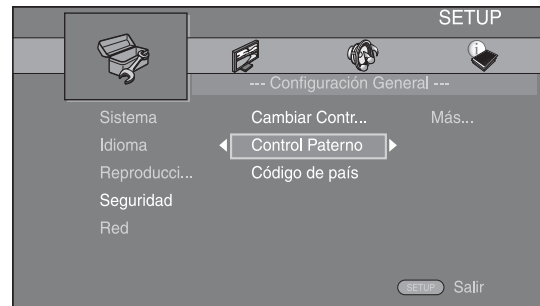

- 4 Introduzca la contraseña con los **botones numéricos**.
 - La contraseña predeterminada es 0000.
 - No puede ir a la siguiente pantalla de configuración hasta que no haya introducido la contraseña correcta.
 - Para cambiar la contraseña, consulte “[Cambiar Contraseña]” (pág. 35).

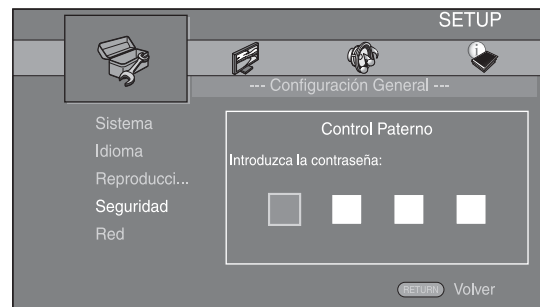

- 5 Seleccione otro elemento.
Pulse **▲/▼** para seleccionar el nivel de Control Paterno para discos BD/DVD. A continuación, pulse **ENTER**.



- 6 Salga de la pantalla del menú.
Pulse **◀** para volver al menú anterior.

Configuración General

Los ajustes predeterminados están marcados con “*”.

■ Sistema

[Protector de pantalla]

Puede definir el protector de pantalla en [Activar]/[Desactivar].

Cuando la opción [Activar] está seleccionada, esta unidad pasa al modo de protector de pantalla si no se utiliza durante 3 minutos.

Activar*, Desactivar

[Apagado Automático]

Tiene la opción de configurar el modo de apagado automático en [Activar]/[Desactivar] cuando la entrada seleccionada es Disco/USB/Red. Si hay otras entradas seleccionadas, el modo de apagado automático puede ajustarse por horas o en [Desactivar].

Disc/USB/Net: Activar*, Desactivar

Otras Entradas: 1 hora, 2 horas, 4 horas, 8 horas*, Desactivar

[Reproducción Automática Disco]

Puede ajustar [Reproducción Automática Disco] en [Activar]/[Desactivar]. Cuando está seleccionada la opción [Activar], el disco se reproducirá automáticamente después de cargarlo.

Activar*, Desactivar

[Control HDMI]

Puede ajustar esta unidad para que reciba una señal de control desde un televisor compatible con la función HDMI a través de un cable HDMI (pág. 12).

Activar, Desactivar*



Para obtener más información sobre la función de control HDMI, consulte página 29.

Nota

Cuando está seleccionada la opción [Activar], el consumo de energía durante el modo de espera aumenta por la función de control HDMI.

[Cargar configuración por defecto]

Puede restablecer todos los ajustes de esta unidad a la configuración predeterminada, excepto el ajuste Seguridad (pág. 35). Para obtener información sobre los ajustes predeterminados, consulte las páginas 31 – 38.

[Actualizar]

Puede actualizar el software de forma manual desde [Almacenamiento USB] o [Red]. Para obtener información sobre la actualización de software, consulte “ACTUALIZACIÓN DE SOFTWARE” (pág. 40).

[Configuración Sencilla]

Puede realizar la Configuración Sencilla (pág. 14).

[Almacenamiento Local]

Puede mostrar información de Almacenamiento Local, formatear Almacenamiento Local y seleccionar [USB Frontal]/[USB Trasera] para guardar los datos de BD-Live.

Para formatear (vaciar) la carpeta “BUDA” en el dispositivo de memoria USB, seleccione [Información] y pulse **ENTER** mientras [Formato] está seleccionado en la pantalla.

USB Frontal, USB Trasera*



Almacenamiento Local se utiliza como memoria auxiliar cuando se reproduce un disco BD.

[Mensaje Reproducción 3D]

Puede activar o desactivar un mensaje de advertencia acerca de la reproducción de vídeo en 3D que aparezca en el televisor cuando esta unidad está activada.

Activar*, Desactivar

■ Idioma

[OSD]

Puede seleccionar el idioma de pantalla, es decir, del menú o los mensajes mostrados en pantalla como, por ejemplo, el menú SETUP.

English, Français, Español, Deutsch, Italiano, Svenska, Nederlandse, Русский, 中文

[Menú]

Puede dar prioridad al idioma del menú del disco.

English, Français, 中文, Español, Deutsch, Italiano, Nederlandse, Portugués, Danés, Svenska, Finlandés, Noruego, Русский, Corea, Japonés, Más

[Audio]

Puede dar prioridad al idioma del audio para la reproducción de BD/DVD. Para obtener más información sobre la configuración de las opciones, consulte “[Menú]” (pág. 34).

[Subtítulo]

Puede dar prioridad al idioma del Subtítulo.

English, Français, 中文, Español, Deutsch, Italiano, Nederlandse, Portugués, Danés, Svenska, Finlandés, Noruego, Русский, Corea, Japonés, Más, Desactivar

Los ajustes predeterminados de [Idioma] son diferentes en función del modelo.

■ Reproducción

[Subtítulos]

Puede ajustar que se visualicen los subtítulos (pág. 48) cuando se reproduce un disco BD/DVD con subtítulos.

Activar, Desactivar*

[Marca de Angulo]

Puede ajustar la visualización de la Marca de Angulo () cuando se reproduce un disco BD/DVD con ángulos múltiples.

Activar*, Desactivar

[Marca PIP]

Puede ajustar la visualización de la Marca PIP () cuando se reproduce un disco BD (pág. 24) con Imagen en imagen.

Activar*, Desactivar

[Marca Audio Secundario]

Puede ajustar la visualización de la Marca Audio Secundario () cuando se reproduce un disco BD con audio secundario.

Activar*, Desactivar

[Memoria última]

Puede establecer si esta unidad recuerda la posición de la última reproducción de un disco cuando se pone en modo de espera o se abre la bandeja portadiscos.

Activar*, Desactivar

Nota

Algunos discos no son compatibles con esta función.

■ Seguridad

[Cambiar Contraseña]

Puede ajustar la contraseña para cambiar el nivel de Control Paterno y Código de país. Consulte “[Control Paterno]” (pág. 35) y “[Código de país]” (pág. 35).

Notas

- La contraseña predeterminada es 0000.
- Si olvida la contraseña, consulte “SOLUCIÓN DE PROBLEMAS” (pág. 41) y configure todos los ajustes de Seguridad en sus valores predeterminados.

[Control Paterno]

En algunos discos de BD/DVD, existe un nivel de control para la visualización del disco en función de la edad del espectador. Puede ajustar el Control Paterno mostrado en pantalla en función del contenido del disco.

Es necesario introducir la contraseña (consulte “[Cambiar Contraseña]” en página 35) antes de ajustar los niveles de Control Paterno.

Después de ajustar el Control Paterno, si reproduce un disco con un nivel más alto del nivel de Control Paterno actual o si desea cambiar el nivel de Control Paterno, aparecerá un cuadro de diálogo solicitando que introduzca la contraseña.

Desactivar*, 1 a 8

[Código de país]

Puede ajustar el Código de país en el que vive. Es necesario introducir la contraseña (consulte “[Cambiar Contraseña]” en página 35) antes de ajustar el Código de país. Este parámetro puede utilizarse para la calificación de Control Paterno y reproducción de discos.

■ Red

[Conexión a Internet]

Puede definir este elemento en [Permitir] cuando utilice BD-Live (pág. 24), DLNA (pág. 18) y actualizar el software desde la red (pág. 40).

Permitir*, Desactivar

[Información]

Puede mostrar la pantalla de información de red. En esta pantalla puede ver información de Interfaz (Ethernet), Tipo de dirección, Dirección IP, Máscara de subred, Default Gateway y DNS.

[Prueba de conexión]

Puede realizar una prueba de conexión a Internet. Si la prueba falla, compruebe la [Configuración IP] (pág. 35) y vuelva a realizar la prueba.

[Configuración IP]

Puede configurar los ajustes de red.

- Auto*** Seleccione este valor para configurar automáticamente los ajustes de red de esta unidad con el servidor DHCP.
- Manual** Seleccione este valor para configurar los ajustes de red (Dirección IP, Máscara de subred, Default Gateway y DNS) manualmente.



- **Botones numéricos** Permiten introducir caracteres.
- **◀▶** Permiten desplazar el elemento resaltado.
- **CLEAR** Permite eliminar un carácter.
- **ENTER** Permite guardar los valores y salir del menú.

[Conexión BD-Live]

Puede definir la restricción de acceso al contenido de BD-Live.

- Autorizada** Permite que todos los discos de BD-Live se conecten a la red.
- Permitida Parcialmente*** Permite únicamente los discos con certificación de propietario.
- Prohibido** Prohíbe que todos los discos de BD-Live se conecten a la red.

[DLNA]

Puede definir la función DLNA (pág. 18) en [Permitir]/[Desactivar]. Cuando no utilice la función DLNA, defínala en [Desactivar].

Permitir*, Desactivar

[Configuración Proxy]

Puede definir Configuración Proxy. Defínalo en [Desactivar] para un uso normal. Seleccione [Permitir] para definir la configuración del proxy.

- Permitir** Activa los ajustes del host y el puerto proxy.
- Desactivar*** Desactiva el servidor proxy. Seleccione esta opción cuando no utilice el servidor proxy.
- Host Proxy** Define el host proxy.
- Puerto proxy** Define el puerto proxy.

Configuración de pantalla

Los ajustes predeterminados están marcados con “* ”.

■ TV

[Salida 3D]

Puede seleccionar salida de vídeo en 3D o 2D desde esta unidad.

Auto* Esta unidad selecciona automáticamente vídeos en 3D o 2D.

Desactivar Esta unidad siempre selecciona vídeos en 2D.

Nota

Aunque establezca [Salida 3D] en [Auto] y reproduzca un disco 3D de BD, este reproductor selecciona imágenes en 2D en función de la conexión y del ajuste del televisor, etc. (pág. 12).

[Pantalla de TV]

Puede ajustar la relación de aspecto de la pantalla del televisor conectado, y ajustar la salida de vídeo.

Si cambia de televisor, por ejemplo porque ha adquirido uno nuevo, y la relación de aspecto de la pantalla del televisor conectado cambia, también tendrá que cambiar el ajuste Pantalla de TV.

16:9 Lleno Seleccionélo cuando conecte la unidad a un televisor con pantalla 16:9. Cuando se reproduce vídeo con una relación de aspecto 4:3, el vídeo se muestra como aparece en la ilustración.

16:9 Normal* Seleccionélo cuando conecte la unidad a un televisor con pantalla 16:9. Cuando se reproduce vídeo con una relación de aspecto 4:3, el vídeo se muestra como aparece en la ilustración.

4:3 Panorámico Seleccionélo cuando conecte la unidad a un televisor con pantalla 4:3. Cuando se reproduce vídeo con una relación de aspecto 16:9, el vídeo se muestra como aparece en la ilustración.

4:3 Buzón Seleccionélo cuando conecte la unidad a un televisor con pantalla 4:3. Cuando se reproduce vídeo con una relación de aspecto 16:9, el vídeo se muestra como aparece en la ilustración.

Tamaño de imagen original	En televisor 16:9 (pantalla panorámica)	
	16:9 Lleno	16:9 Normal
 4:3		

Tamaño de imagen original	En televisor 4:3	
	4:3 Panorámico	4:3 Buzón
 16:9		

[Seleccionar Salida de Vídeo]

Puede seleccionar la resolución de salida de vídeo entre [Compuesta], [HDMI Auto], [HDMI 1080p], [HDMI 1080i], [HDMI 720p], [HDMI 480p/576p] y [HDMI 480i/576i]. Cuando se define en [HDMI Auto], la resolución se ajusta a la resolución máxima según el televisor conectado. Para obtener más información sobre los formatos de salida, consulte “Acerca de los formatos de salida de vídeo” (pág. 39).

Compuesta, HDMI Auto*, HDMI 1080p, HDMI 1080i, HDMI 720p, HDMI 480p/576p, HDMI 480i/576i

Notas

- Si conecta el televisor y esta unidad a través de la toma VIDEO, seleccione [Compuesta], [HDMI 480p/576p] o [HDMI 480i/576i].
- Para emitir audio HD (como Dolby TrueHD o DTS-HD) desde un terminal HDMI, configure [Seleccionar Salida de Vídeo] como [HDMI Auto] o un ajuste superior a [HDMI 720p].

[Sistema de TV]

Puede seleccionar el valor de [Sistema de TV] entre [PAL], [NTSC] y [Multi]. Ajuste el mismo valor de Sistema de TV que su televisor. Para obtener más información sobre los formatos de salida, consulte “Acerca de los formatos de salida de vídeo” (pág. 39).

NTSC, PAL*, Multi (Modelos de Australia, Asia, China, Reino Unido, Europa y Rusia)

NTSC*, PAL, Multi (Modelos de América Central y del Sur)

[Color Space]

Puede seleccionar la salida Color Space (pág. 48) desde HDMI. Esta función está disponible cuando la unidad se conecta con un cable HDMI.

YCbCr 4:4:4* Permite definir Color Space en YCbCr 4:4:4.

YCbCr 4:2:2 Permite definir Color Space en YCbCr 4:2:2.

Full RGB Si se ha configurado RGB y el blanco y negro de la pantalla está demasiado difuminado, seleccione este elemento. Esta opción se aplica si un componente conectado admite el intervalo RGB 0-255.

RGB Permite la salida de la señal de vídeo con el rango normal de señal.

Nota

Esta función solo está disponible en televisores que admitan dicha función.

[HDMI Deep Color]

Si su televisor es compatible con Deep Color (pág. 48), configure esta opción en función de su televisor. Esta función está disponible cuando la unidad se conecta con un cable HDMI.

30 bits, 36 bits, Desactivar*

[HDMI 1080p 24Hz]

Permite la salida del Vídeo BD codificado con una velocidad de fotogramas de 24 Hz en HDMI 1080p 24Hz. Con esta función es posible que disponga de una reproducción de vídeo más suave. Esta función está disponible si el televisor admite esta función y la unidad está conectada con un cable HDMI. Para obtener más información sobre los formatos de salida, consulte “Acerca de los formatos de salida de vídeo” (pág. 39).

Auto*, Desactivar**Nota**

Este parámetro está desactivado cuando la resolución de salida es diferente de 1080p.

[Sincronismo de labios]

Puede definir o ajustar la función Sincronismo de labios (pág. 49).

Auto*	Esta unidad ajusta automáticamente la función Sincronismo de labios.
Manual	Puede ajustar la función Sincronismo de labios manualmente. Puede establecer el retraso del audio para contenido 2D y 3D de forma independiente.
	2D
	3D
Desactivar	Esta unidad no ajusta la función Sincronismo de labios.

■ Procesamiento de Vídeo**[Modo de vídeo]**

Puede seleccionar [Modo de vídeo] más abajo.

Estándar*	La imagen es más natural y equilibrada. Este modo es adecuado para usos normales.
Rico	La imagen es más viva e intensa.
Cine	La imagen es adecuada para ver películas en una habitación a oscuras.
Particularizado	Puede ajustar la imagen visual manualmente. Pulse ▲/▼ para seleccionar el parámetro y, a continuación, pulse ◀/▶ para ajustar la cifra.

Brillo

Ajusta el brillo global de la imagen.

Saturación

Ajusta la riqueza de color de la imagen proyectada.

Tonalidad

Ajusta el tono de la imagen proyectada.

Contraste

Ajusta las áreas claras (niveles blancos) de la imagen.

Nitidez

Ajusta la nitidez de los elementos del vídeo.

CTI

Suaviza los bordes de las imágenes en color. De este modo, las imágenes en color se distinguen más.

Los valores predeterminados son 0.

[Ajuste de color]

Ajusta Brillo/Saturación/Tonalidad para cada color (Rojo/Verde/Azul/Amarillo/Cian/Magenta). Para utilizar esta función, configure [Modo de vídeo] como [Particularizado]. Para obtener más información sobre la configuración de las opciones, consulte “[Modo de vídeo]” (pág. 37).

Los valores predeterminados son 0.

[Reducción de ruido]

Puede configurar la Reducción de ruido a un nivel entre 0 y 3. 0 equivale a desactivado y 3 es el nivel máximo.

0*, 1, 2, 3

[Modo desentrelazado]

Puede seleccionar cómo detectar la señal de vídeo.

Defínalo en [Auto] para un uso normal. Cuando aparece en la pantalla un ruido de desgarro horizontal, configure esta opción en [Película]/[Vídeo] para eliminar el ruido.

Auto*, Película, Vídeo

Configuración de audio

Los ajustes predeterminados están marcados con “*”.

■ Salida de audio

[HDMI]

Puede seleccionar el modo de salida del terminal HDMI.

Bitstream, PCM, Desactivar*

Notas

- Para emitir sonido desde los altavoces o auriculares, seleccione [Desactivar].
- No se puede escuchar sonido del iPod en un televisor conectado a esta unidad a través del cable HDMI.
- Para emitir audio HD (como Dolby TrueHD o DTS-HD) desde un terminal HDMI, configure [Seleccionar Salida de Vídeo] como [HDMI Auto] o un ajuste superior a [HDMI 720p] (pág. 36).

[DRC]

Puede definir la función DRC (Control de gama dinámica) (pág. 49) en [Activar]/[Desactivar]/[Auto]. Cuando se define en [Auto], DRC se enciende automáticamente para una fuente con información DRC en formato Dolby TrueHD. DRC hace que los sonidos fuertes, como los oclusivos, suenen más bajo y que las conversaciones sean más audibles. Resulta útil cuando se ven películas de noche.

Desactivar*, Activar, Auto

■ Post-procesamiento

[Mezcla ascendente]

Permite convertir la señal de audio de 2 canales en multicanal (eficaz en la salida HDMI). Para convertir la señal en señal multicanal, seleccione [DTS NEO:6] y, seguidamente, seleccione [Cine] o [Música].

Desactivar*, DTS NEO:6

■ Sistema de Información

Se muestran la versión de software y la dirección MAC (pág. 49).

Acerca de los formatos de salida de vídeo

Si [Sistema de TV] se define en [NTSC]

	Resolución	Compuesta	HDMI Auto	HDMI 480i/576i	HDMI 480p/576p	HDMI 720p	HDMI 1080i	HDMI 1080p	
								24 Hz	Otros
HDMI	Reproducción de BD	480p	Máx.	480i	480p	720p 60 Hz	1080i 60 Hz	1080p 24 Hz	1080p 60 Hz
	otros							1080p 60 Hz	
VIDEO	Reproducción de BD	480i	OFF	480i	480i	OFF			
	otros								

Si [Sistema de TV] se define en [PAL]

	Resolución	Compuesta	HDMI Auto	HDMI 480i/576i	HDMI 480p/576p	HDMI 720p	HDMI 1080i	HDMI 1080p	
								24 Hz	Otros
HDMI	Reproducción de BD	576p	Máx.	576i	576p	720p 50 Hz	1080i 50 Hz	1080p 24 Hz	1080p 50 Hz
	otros							1080p 50 Hz	
VIDEO	Reproducción de BD	576i	OFF	576i	576i	OFF			
	otros								

Si [Sistema de TV] se define en [Multi]

Si [Sistema de TV] está configurado como [Multi], la salida de la señal de vídeo tiene la misma frecuencia que la fuente. Consulte las tablas anteriores para obtener información sobre la configuración de frecuencia del televisor y la resolución de la señal de vídeo de salida.

Si se muestra una pantalla de menú, como por ejemplo SETUP, la salida de la señal de vídeo tiene la misma frecuencia que el origen.

Notas

- “Máx.” en la tabla significa que la resolución se ha definido en la resolución máxima admitida por el televisor conectado.
- El parámetro [HDMI 1080p 24Hz] está desactivado cuando la resolución de salida es diferente de [HDMI 1080p].
- No se emiten señales desde la toma VIDEO si la resolución de salida está definida en [HDMI Auto], [HDMI 720p], [HDMI 1080i] o [HDMI 1080p].
- Cuando [Sistema de TV] se define en [NTSC] y el origen de vídeo no es 60 Hz, la salida de vídeo se convierte a 60 Hz.
- Cuando [Sistema de TV] se define en [PAL] y el origen de vídeo no es 50 Hz, la salida de vídeo se convierte a 50 Hz.

ACTUALIZACIÓN DE SOFTWARE

Algunos de los discos BD recién lanzados no se pueden reproducir a menos que actualice el software de la unidad a la versión más reciente. Le recomendamos la actualización para que la unidad funcione con el software más actual.

Para comprobar la disponibilidad de una actualización de software, visite

<http://download.yamaha.com/>

Nota

No saque el dispositivo de memoria USB, no ponga la unidad en modo de espera ni desenchufe el cable de alimentación o el cable LAN mientras se lleva a cabo la actualización de software.

Actualización del software

- 1 Prepare la actualización de software.
Si actualiza el software desde [Red]:
Confirme que la unidad está conectada a la red.
Si actualiza el software desde [Almacenamiento USB]:
 - ① Guarde el paquete de archivos de actualización en la carpeta correspondiente en el dispositivo de memoria USB. Para obtener más información, consulte el documento de procedimientos adjunto con el paquete de archivos de actualización.
 - ② Conecte el dispositivo de memoria USB.
Si la actualización de software se inicia automáticamente cuando se conecta la memoria USB, vaya al paso 2 siguiente.
- 2 Seleccione el método de actualización e inicie la actualización desde el menú SETUP.
 - ① Pulse **SETUP** para mostrar la pantalla del menú SETUP.
 - ② Seleccione [Configuración General] → [Sistema] → [Actualizar].
 - ③ Seleccione el elemento que contiene el paquete de archivos de actualización desde [Almacenamiento USB]/[Red].

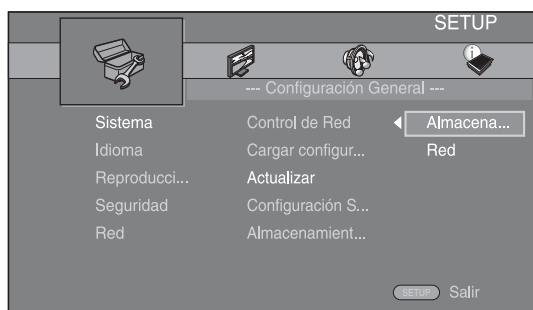







- 3 Inicie la actualización siguiendo los mensajes en pantalla.

SOLUCIÓN DE PROBLEMAS

Consulte la tabla de abajo cuando esta unidad no funcione correctamente. Si el problema no está en la lista de abajo o las instrucciones no sirven de ayuda, apague esta unidad, desconecte el cable de alimentación y póngase en contacto con el centro de servicio o concesionario autorizado de Yamaha más cercano.

Problemas generales

Problema	Causa	Remedio	Página
No hay alimentación.		Pulse  en el panel delantero para encender la alimentación.	5
Esta unidad no se enciende o entra en el modo de espera poco después de conectar la alimentación.	El cable de alimentación no está conectado o la clavija no está bien insertada.	Conecte firmemente el cable de alimentación.	11
	Esta unidad ha sido expuesta a una descarga eléctrica externa fuerte (rayo o electricidad estática intensa).	Ponga la unidad en el modo de espera, desconecte el cable de alimentación, vuelva a conectarlo después de 30 segundos y, a continuación, utilícela normalmente.	—
Esta unidad no funciona correctamente.	Esta unidad debe reiniciarse.	Mantenga pulsado  en el panel delantero durante unos 5 segundos para reiniciar esta unidad. Para reiniciarla completamente, desenchufe el cable de alimentación de la toma de CA durante entre 5 y 10 segundos, vuelva a enchufarlo y, a continuación, encienda la unidad.	5
El disco no puede reproducirse.	No se ha configurado el Asistente inicial.	Configure el Asistente inicial cuando encienda esta unidad por primera vez tras realizar una compra o actualización.	14
No hay sonido.	No se ha seleccionado una fuente de entrada apropiada.	Seleccione una fuente de entrada apropiada con el selector INPUT del panel delantero (o los botones de selección de fuente del mando a distancia).	5
	Las conexiones de los altavoces están flojas.	Asegure las conexiones.	10
	La función de silencio está activada.	Cancele la función de silencio.	7
	El volumen está bajo.	Suba el volumen.	7
	Hay señales que la unidad no puede reproducir y que recibe de un componente, como por ejemplo un CD-ROM.	Reproduzca una fuente cuyas señales pueda reproducir esta unidad.	3
	[Control HDMI] está ajustado en [Desactivar].	Al conectar un televisor compatible con ARC (canal de retorno de audio) y esta unidad con un cable HDMI, ajuste [Control HDMI] en [Activar].	34
Los altavoces o los auriculares no emiten sonido.	[HDMI] para salida de audio en el menú SETUP no está ajustado en [Desactivar].	Ajuste [HDMI] en [Desactivar].	38
No hay imagen.	Los cables están mal conectados.	Asegúrese de que los cables están conectados correctamente.	12
		Compruebe que el televisor conectado tiene seleccionada la entrada correcta.	12
		Conecte esta unidad al televisor con la toma VIDEO mediante el cable de clavijas de vídeo suministrado. – Si la imagen sigue sin mostrarse con esta unidad conectada al terminal VIDEO, mantenga pulsado  y  en el panel frontal unos 5 segundos sin ningún disco insertado y con la reproducción parada para ir a NTSC/PAL	12
	El sistema del televisor no está configurado correctamente.	Mantenga pulsado  y  simultáneamente en el panel frontal durante unos 5 segundos sin ningún disco insertado y con la reproducción parada para ir a NTSC/PAL. Vuelva a configurar la resolución correcta al conectarse a través de HDMI (pág. 36).	—

Problema	Causa	Remedio	Página
La unidad se apaga de forma repentina.	Está configurado el temporizador de apagado.	No se trata de ningún error. Encienda esta unidad y reproduzca la fuente de nuevo.	29
	[Apagado Automático] está ajustado en [Activar].	Ajuste [Apagado Automático] en [Desactivar].	34
Se ha borrado el ajuste del reloj.	Se ha desconectado el cable de alimentación.	Conecte el cable de alimentación y, a continuación, ajuste el reloj de nuevo.	—
Solo se oye sonido del altavoz de un lado.	Los cables están mal conectados.	Conecte los cables correctamente. Si el problema persiste, los cables podrían estar defectuosos.	10
Hay interferencia de ruido procedente de un equipo digital o de radiofrecuencia.	La unidad está demasiado cerca de un equipo digital o de alta frecuencia.	Separe más la unidad de dicho equipo.	—
Esta unidad hace un sonido de chasquido cuando comienza la reproducción o al cargar un disco.		Estos sonidos no indican una avería, sino que son condiciones normales de funcionamiento de esta unidad.	—
El altavoz de graves no emite sonido.	El altavoz de graves no está conectado correctamente.	Compruebe que el altavoz de graves esté conectado correctamente.	10
Los ajustes del sistema se cambian automáticamente.	Cuando [Control HDMI] está ajustado en [Activar], al utilizar el televisor (por ejemplo, al cambiar de canal, etc.) se cambian los ajustes del sistema.	Ajuste [Control HDMI] en [Desactivar] o vuelva a configurar el sistema con el mando a distancia.	34
La función de control HDMI no funciona correctamente.	[Control HDMI] está ajustado en [Desactivar].	Ajuste [Control HDMI] en [Activar].	34
	La función de control HDMI está desactivada en el televisor.	Consulte el manual entregado con el televisor y compruebe la configuración.	—
El sincronismo de labios automático no funciona aunque [Sincronismo de labios] esté ajustado en [Auto].	El televisor no es compatible con el sincronismo de labios automático.	Ajuste [Sincronismo de labios] en [Manual] y, a continuación, ajuste el retardo de la salida de audio manualmente.	37

Recepción de la radio

Problema	Causa	Remedio	Página
La recepción estéreo por FM es mala.	La antena no está conectada correctamente.	Verifique las conexiones de la antena.	10
	Las características de las emisiones estéreo de FM pueden causar este problema si el transmisor está demasiado lejos o la entrada de la antena es mala.	Intente utilizar una antena de FM direccional de alta calidad.	—
		Active el modo monoaural.	26
La emisora deseada no se puede sintonizar con el método de sintonización automática.	La señal es demasiado débil.	Utilice una antena de FM direccional de alta calidad.	—
		Utilice el método de sintonización manual.	26
La función de selección de presintonía no funciona.	Es posible que se haya borrado la presintonía (memoria).	Presintonice las emisoras de radio de nuevo.	26
Hay distorsión y no se puede obtener una buena recepción a pesar de utilizar una buena antena de FM o una antena exterior.	Se está produciendo reflexión multirruta o algún otro tipo de interferencia de radio.	Cambie la altura, la dirección o la posición de la antena.	—

iPod

Nota

En caso de producirse un error de transmisión sin que aparezca un mensaje de estado en el visor del panel delantero de esta unidad, compruebe la conexión de su iPod (consulte la 11).

Mensaje de estado	Causa	Remedio	Página
READING	La unidad está reconociendo la conexión con el iPod.	Si el mensaje sigue apareciendo en el visor del panel delantero y no comienza la reproducción, vuelva a conectar el iPod.	—
UNKNOWN	Hay un problema con la trayectoria de la señal del iPod a esta unidad.	Vuelva a conectar el iPod.	11
	El iPod utilizado no es compatible con esta unidad.	Esta unidad solo es compatible con el iPod classic, iPod nano (2ª, 3ª, 4ª, 5ª y 6ª generación), iPod touch (1ª, 2ª, 3ª y 4ª generación), iPhone, iPhone 3G/3GS, iPhone 4 y iPad.	11
	El software del iPod no está actualizado.	Actualice el software del iPod para obtener la versión más reciente.	—
STOP	La reproducción del iPod ha terminado. Por ejemplo, todas las canciones del álbum seleccionado han terminado de reproducirse.		
NO iPod	El iPod está desconectado de esta unidad.	Conecte el iPod con esta unidad mediante un cable USB.	11

Problema	Causa	Remedio	Página
No hay sonido.	La unidad está apagada.	Conecte correctamente el cable de alimentación.	11
	No se ha actualizado la versión del software del iPod.	Descargue la versión de iTunes más reciente para actualizar la versión del software del iPod.	—
	El iPod está en proceso de conexión con esta unidad.	Espere un momento.	—
No hay sonido.	El iPod no está conectado correctamente.	Conecte el iPod con esta unidad mediante un cable USB.	11
El iPod emite sonido, pero no puede controlarlo con esta unidad ni con el mando a distancia.			
No se escucha sonido del iPod en el televisor.	No se puede escuchar sonido del iPod en un televisor conectado a esta unidad a través del cable HDMI.	Utilice los altavoces de esta unidad.	—
Esta unidad no puede controlarse con el mando a distancia.	El iPod no es compatible con esta unidad.	Esta unidad solo es compatible con el iPod classic, iPod nano (2ª, 3ª, 4ª, 5ª y 6ª generación), iPod touch (1ª, 2ª, 3ª y 4ª generación), iPhone, iPhone 3G/3GS, iPhone 4 y iPad.	11
	El iPod no está conectado correctamente.	Conecte el iPod con esta unidad mediante un cable USB.	11
	La versión del software del iPod no se ha actualizado.	Actualice el software del iPod para obtener la versión más reciente. Si no es posible resolver el problema, ni siquiera con el software más reciente, restablezca el iPod.	—
No es posible realizar funciones de control desde el iPod.	El iPod no está conectado correctamente.	Conecte el iPod con esta unidad mediante un cable USB.	11
La información de reproducción no se muestra en el visor del panel delantero.	El iPod utilizado no es compatible con la visualización de información de reproducción.	Esta unidad solo es compatible con el iPod classic, iPod nano (2ª, 3ª, 4ª, 5ª y 6ª generación), iPod touch (1ª, 2ª, 3ª y 4ª generación), iPhone, iPhone 3G/3GS, iPhone 4 y iPad.	11

Problema	Causa	Remedio	Página
La batería del iPod no se carga.	El iPod no está conectado correctamente.	Conecte el iPod con esta unidad mediante un cable USB.	11
	El iPod no es compatible con esta unidad.	Esta unidad solo es compatible con el iPod classic, iPod nano (2ª, 3ª, 4ª, 5ª y 6ª generación), iPod touch (1ª, 2ª, 3ª y 4ª generación), iPhone, iPhone 3G/3GS, iPhone 4 y iPad.	11

USB

Nota

En caso de producirse un error de transmisión sin que aparezca un mensaje de estado en el panel delantero de esta unidad, compruebe la conexión del dispositivo USB (consulte la página 13).

Mensaje de estado	Causa	Remedio	Página
USB ERROR	El dispositivo USB conectado no puede reproducirse en esta unidad.	Desconecte el dispositivo USB. Cambie a otra fuente de entrada que no sea USB y vuelva a seleccionar USB como fuente de entrada. Vuelva a conectar un dispositivo USB que se pueda reproducir.	13
	El dispositivo USB está conectado en ángulo.		

Problema	Causa	Remedio	Página
El archivo del dispositivo USB no puede reproducirse.	No se reconoce el dispositivo USB.	Vuelva a conectar el dispositivo USB.	13
		Si se suministra un adaptador de CA con el dispositivo, conéctelo.	—
	Las conexiones del dispositivo USB son incorrectas.	Vuelva a conectar el dispositivo USB.	13
	El formato del archivo no es compatible con esta unidad.	Cambie el archivo por un archivo grabado correctamente que se pueda reproducir con esta unidad.	3
	Si las soluciones anteriores no resuelven el problema, el dispositivo USB no puede reproducirse en esta unidad.	Pruebe con otro dispositivo USB.	—

Reproducción de disco

■ Problemas generales

Problema	Causa	Remedio	Página
No se escucha sonido o está distorsionado.	La frecuencia de muestreo de un archivo de audio o vídeo no es compatible con esta unidad.	Compruebe que la frecuencia de muestreo y la velocidad de transferencia de bits de un archivo de audio o vídeo sean compatibles con esta unidad.	3
		El audio puede no emitirse dependiendo del estado de grabación del audio, por ejemplo, cuando se haya grabado audio que no sea una señal de audio o audio no estándar.	3
		No hay sonido durante el modo de reproducción fija, cámara lenta, avance rápido y retroceso rápido.	—

Problema	Causa	Remedio	Página
El disco no se reproduce.	El disco no está finalizado.	Los discos CD-R/RW, DVD+R/RW/R DL y DVD-R/RW/R DL deben estar finalizados.	3
	El disco está cargado al revés.	Extraiga el disco y, a continuación, cárguelo con la cara de la etiqueta hacia arriba.	—
	El disco es defectuoso.	Intente reproducir otro disco. Si de esta forma se resuelve el problema, el disco que desea reproducir está defectuoso.	—
	El formato del archivo no es compatible con esta unidad.	Compruebe que el formato del archivo es compatible con esta unidad.	3
Algunas operaciones con botones no funcionan.	El disco cargado en esta unidad no es compatible.	Utilice un disco compatible con esta unidad.	3
La reproducción no comienza inmediatamente después de pulsar ►/■ en esta unidad o ► en el mando a distancia.	El disco está sucio.	Extraiga el disco y límpielo.	4
	El disco cargado en esta unidad no es compatible.	Utilice un disco compatible con esta unidad.	3
	Si esta unidad se ha trasladado desde un lugar frío hasta un lugar cálido, podría haberse formado condensación en la lente de lectura de disco.	Espere una hora o dos, hasta que la unidad se adapte a la temperatura de la habitación e inténtelo de nuevo.	—
[No Disc] aparece en pantalla, aunque hay un disco en la bandeja del disco.	El disco cargado en esta unidad no es compatible.	Utilice un disco compatible con esta unidad.	3
	El disco está sucio.	Extraiga el disco y límpielo.	4
	El disco está cargado al revés.	Extraiga el disco y, a continuación, cárguelo con la cara de la etiqueta hacia arriba.	—
No se escucha el audio o las imágenes no se reproducen correctamente.	El disco tiene protección por derechos de autor.	En algunos discos en los que se ha grabado contenido protegido por derechos de autor es posible que no se emita el audio o que las imágenes no se reproduzcan adecuadamente.	—

■ Imagen

Problema	Causa	Remedio	Página
La pantalla se congela y las teclas de operación no responden.		Pulse ■ y, después, reinicie la reproducción.	—
	Esta unidad debe reiniciarse.	Desconecte la alimentación y conéctela de nuevo.	—
		Mantenga pulsado ⏻ en el panel delantero durante unos 5 segundos para reiniciar esta unidad.	—
La salida de vídeo no tiene la resolución deseada.	La resolución no está bien configurada.	Ajuste la resolución deseada.	36
El vídeo de ancho horizontal aparece estirado verticalmente o aparecen bandas negras en las partes superior e inferior de la pantalla. O el vídeo 4:3 aparece estirado horizontalmente.	La relación de aspecto del televisor no está bien configurada.	Cambie la relación de aspecto del televisor.	36
Aparece ruido cuadrado (mosaicos) en la pantalla.		Se pueden ver bloques en las imágenes en escenas que contengan movimientos rápidos debido a las características de la tecnología de compresión de imagen digital.	—
La pantalla de reproducción se alterará si se graba vídeo DVD en una videgrabadora o se reproduce a través de una videgrabadora.	El disco tiene protección por derechos de autor.	Esta unidad cumple la normativa de protección contra copias analógicas. Algunos discos contienen una señal de prohibición de copia. Si intenta reproducir tales discos a través de una videgrabadora o grabar en una videgrabadora y reproducir la señal, la protección contra copia impedirá la reproducción normal.	—

Mando a distancia

Problema	Causa	Remedio	Página
El mando a distancia no funciona bien.	Está utilizando el mando a distancia fuera de la distancia de funcionamiento.	Para obtener más información sobre la distancia de funcionamiento del mando a distancia, consulte "Utilización del mando a distancia".	9
	El sensor del mando a distancia de esta unidad está expuesto a la luz solar o iluminación directa.	Cambie la iluminación u orientación de esta unidad.	—
	La batería está agotada.	Cambie la pila por una nueva.	9
	Hay obstáculos entre el sensor de esta unidad y el mando a distancia.	Aparte los obstáculos.	—

Red



Problema	Causa	Remedio	Página
No se puede conectar a Internet.	Los cables están mal conectados.	Conecte correctamente el cable de red.	13
	El equipo conectado está apagado.	Encienda el equipo conectado como, por ejemplo, un módem o enrutador de banda ancha.	—
	La conexión del módem y/o del enrutador de banda ancha es incorrecta.	Conecte correctamente el módem y/o el enrutador de banda ancha.	—
	La configuración de la red no es correcta.	Configure correctamente el valor o valores de la red. Consulte "Red".	35
No se pueden descargar contenidos BD-Live.	Los cables están mal conectados.	Conecte correctamente el cable de red.	13
	Las conexiones del dispositivo USB son incorrectas.	Conecte el dispositivo de memoria USB correctamente. Compruebe que el dispositivo de memoria USB está conectado al puerto USB de esta unidad.	13
	El disco BD no es compatible con BD-Live.	Compruebe si el disco BD es compatible con BD-Live.	—
	La configuración de la red no es correcta.	Compruebe el ajuste de [Conexión a Internet].	35
	El dispositivo de memoria USB no es compatible.	Conecte el dispositivo de memoria USB formateado en FAT16 o FAT32.	13
	No hay suficiente espacio libre en el dispositivo de memoria USB.	Se recomienda conectar el dispositivo de memoria USB con al menos 2 GB de espacio libre. Si no hay suficiente espacio libre, formatee el dispositivo de memoria USB.	34
	Consulte el manual del usuario suministrado del disco o póngase en contacto con el fabricante del disco.	—	
No se puede detectar el servidor DLNA.	Los cables están mal conectados.	Conecte correctamente el cable de red.	13
	El equipo conectado está apagado.	Encienda el equipo conectado como, por ejemplo, un enrutador de banda ancha o el servidor.	—
	El punto de acceso de esta unidad y del servidor no son los mismos.	Asegúrese de que esta unidad y el servidor están conectados al mismo punto de acceso.	—
	La configuración de la red no es correcta.	Configure correctamente el valor o valores de la red. Consulte "Red".	35
	El servidor DLNA no autoriza esta unidad.	Dependiendo del servidor DLNA, es posible que sea necesario autorizar la unidad desde el servidor.	—
No se puede reproducir el archivo en el servidor doméstico de red.	El archivo no es compatible con esta unidad.	Asegúrese de que el archivo se puede reproducir.	3
	La configuración de DLNA no es correcta.	Compruebe la configuración del servidor DLNA.	35
		La calidad de funcionamiento y reproducción podría verse afectada por las condiciones de la red doméstica.	—

Mensajes en pantalla

Los mensajes siguientes aparecerán en la pantalla del televisor si el disco que intenta reproducir no es apropiado o la operación no es correcta.

Mensaje de error	Causa	Remedio	Página
Fichero no compatible	El archivo no es compatible con esta unidad.	Consulte “Tipos de discos/archivos que se pueden utilizar con esta unidad”.	3
¡Código de región erróneo!	El disco tiene un código de región incompatible.	Consulte “Información de gestión de la región”.	3
La red ha fallado.	Esta unidad no se puede conectar a la red.	Compruebe la conexión y los ajustes de la red.	13 35
Red está bien, proxy ha fallado.	Esta unidad no se puede conectar al servidor proxy.	Consulte “[Configuración Proxy]”.	35
La conexión BD-Live está prohibida en el menú SETUP.	La conexión de BD-Live está prohibida.	Consulte “[Conexión BD-Live]”.	35
¡Ningún archivo de actualización válido!	No se encuentra el archivo de actualización.	Compruebe si el archivo de actualización está en la carpeta apropiada.	—
¡La actualización ha fallado por alguna razón!	La actualización ha fallado.	Compruebe si el archivo de actualización está dañado o es ilegible.	—

Otros

Problema	Causa	Remedio	Página
He olvidado la contraseña.		Cuando no haya ningún disco en la bandeja y la reproducción esté detenida, mantenga pulsados simultáneamente los botones  y  en el panel delantero durante unos 5 segundos para restaurar todos los ajustes de seguridad predeterminados de esta unidad (pág. 35) Una vez que la alimentación se desconecte automáticamente, pulse  para volver a conectarla.	—

GLOSARIO

AIR SURROUND XTREME

Esta unidad utiliza nuevas tecnologías y algoritmos que permiten obtener un sonido envolvente de cinco canales con solo altavoces frontales y sin necesidad de reflejar los haces en las paredes.

Normalmente hacen falta dos altavoces frontales, un altavoz central, dos altavoces envolventes y un altavoz de graves para disfrutar de sonido envolvente de 5.1 canales.

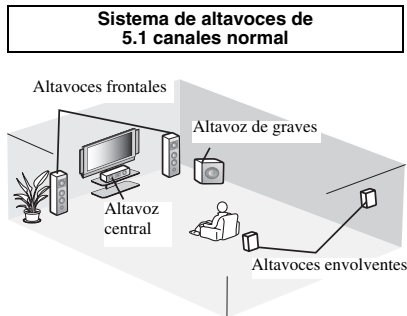

Sistema de 5.1 canales virtual

La tecnología AIR SURROUND XTREME permite disfrutar de un realista sonido de 5.1 canales con solo altavoces frontales gracias a la simulación de altavoces virtuales en sustitución del altavoz central y los altavoces envolventes.

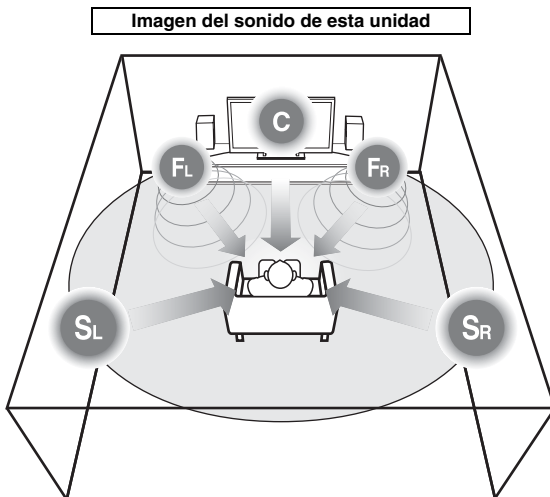

El sistema crea un sonido envolvente de 5.1 canales virtuales con los altavoces.

C: altavoz central

FR, FL: altavoces frontales

SR, SL: altavoces virtuales envolventes

AVCHD

AVCHD es un nuevo formato (estándar) para cámaras de vídeo de alta definición que se puede utilizar para grabar y reproducir imágenes de alta definición (HD).

BD-Live™

BD-Live es un estándar de BD que utiliza una conexión de red y permite a esta unidad conectarse a Internet para descargar vídeos promocionales y otros datos.

BDMV

BDMV (Blu-ray Disc Movie, BD-MV) se refiere a uno de los formatos de aplicación utilizados para BD-ROM, que constituye una de las especificaciones de Blu-ray Disc. BDMV es un formato de grabación equivalente al Vídeo DVD de la especificación DVD.

Blu-ray 3D™

Blu-ray 3D le permite ver imágenes 3D de alta definición completa.

BONUSVIEW™

Los discos compatibles con BONUSVIEW le permiten disfrutar simultáneamente de subcanal de vídeo para dos pantallas, subcanal de audio y subtítulos. Aparece una pequeña pantalla dentro de la pantalla principal durante la reproducción (Imagen en imagen).

Closed Caption (Subtítulos)

La audiodescripción es un tipo de subtítulo y la diferencia entre los subtítulos y la audiodescripción es que los primeros están diseñados para personas sin problemas auditivos, mientras que los segundos lo están para personas que no oyen. Los subtítulos no suelen mostrar todo el audio. La audiodescripción muestra efectos de sonido (por ejemplo, "suena el teléfono" y "ruido de pasos"), mientras que los subtítulos no lo hacen. Antes de seleccionar este ajuste, asegúrese de que el disco contiene información de audiodescripción.

Color Space

Color Space es una gama de colores que se puede representar. RGB es un espacio de color basado en el modelo de color RGB (rojo, verde y azul) y se utiliza normalmente para monitores de PC. YCbCr es un espacio de color basado en una señal de luminancia (Y) y dos señales de diferencia de color (Cb y Cr).

Deep Color

Deep Color se refiere al uso de diversas profundidades de color en pantallas, a partir de las profundidades de 24 bits de versiones anteriores de la especificación HDMI. Esta profundidad de bits adicional permite que las pantallas HDTV y otros tipos de pantallas pasen de millones a miles de millones de colores y eliminan la aparición de bandas de color en pantallas y permite unas transiciones tonales suaves y una gradación ligera entre colores. La mayor relación de contraste permite representar muchos más tonos de gris entre blanco y negro. Además, Deep Color aumenta el número de colores disponibles dentro de los límites definidos por el espacio de color RGB o YCbCr.

Dolby Digital

Un sistema de sonido desarrollado por Dolby Laboratories Inc. que da un ambiente de sala de cine a la salida de audio cuando el producto está conectado con un amplificador o procesador Dolby Digital.

Dolby Digital Plus

Un sistema de sonido desarrollado como una extensión de Dolby Digital. Esta tecnología de codificación de audio soporta sonido envolvente de 7.1 multicanales.

Dolby TrueHD

Dolby TrueHD es una tecnología de codificación sin pérdidas que soporta hasta 8 canales de sonido envolvente multicanal para los discos ópticos de próxima generación. El sonido reproducido es totalmente fiel a la fuente original, bit a bit.

DRC (Control de gama dinámica)

DRC le permite ajustar la gama entre los sonidos más alto y más bajo (gama dinámica) para reproducir a un volumen intermedio. Utilícela cuando sea difícil escuchar los diálogos o durante las horas en que la reproducción pueda molestar a los vecinos.

DTS

Un sistema de sonido digital desarrollado por DTS, Inc. para su uso en salas de cine.

DTS-HD High Resolution Audio

DTS-HD High Resolution Audio es una nueva tecnología desarrollada para el formato de disco óptico de alta definición de próxima generación.

HDMI

HDMI (High-Definition Multimedia Interface, Interfaz Multimedia de Alta Definición) es una interfaz que permite disponer de vídeo y audio en una sola conexión digital. La conexión HDMI lleva señales de vídeo, tanto estándar como de alta definición, y señales de audio en multicanal a componentes A/V, como por ejemplo televisores equipados con HDMI en forma digital y sin degradación.

Buzón (LB 4:3)

Un tamaño de pantalla con barras negras en las partes superior e inferior de la imagen para permitir la visualización de material en pantalla ancha (16:9) en un televisor 4:3 conectado.

Sonido PCM lineal

PCM lineal es un formato de grabación de señales utilizado para CD de audio y en algunos discos DVD y Blu-ray. El sonido de CD de audio se graba a 44,1 kHz con 16 bits. (El sonido se graba entre 48 kHz con 16 bits y 96 kHz con 24 bits en discos DVD y entre 48 kHz con 16 bits y 192 kHz con 24 bits en discos BD.)

Sincronismo de labios

Sincronismo de labios, una abreviatura de "lip synchronization", o sincronización de labios, es un término que hace referencia tanto a un problema habitual como a la posibilidad de mantener sincronizadas las señales de audio y vídeo durante la postproducción y la transmisión. La latencia de audio y vídeo requiere complejos ajustes por parte del usuario, pero HDMI incorpora una función de sincronización automática de audio y vídeo que permite a los dispositivos sincronizarse de forma automática y precisa y sin la intervención del usuario.

Dirección MAC

La dirección MAC es un valor único asignado a un dispositivo de red para fines identificativos.

Panorámico (PS 4:3)

Un tamaño de pantalla que recorta los lados de la imagen para permitir la visualización de material de pantalla ancha (16:9) en un televisor 4:3 conectado.

Subtítulos

Son las líneas de texto que aparecen en la parte inferior de la pantalla y que traducen o transcriben el diálogo. Están grabadas en muchos discos de vídeo DVD y BD.

Menú principal

En un Vídeo BD/Vídeo DVD es el menú para seleccionar elementos como el capítulo que se va a reproducir y el idioma de los subtítulos. En algunos vídeos DVD, al menú principal también se le denomina "Menú de títulos".

x.v.Color

x.v.Color reproduce una gama de colores más amplia que antes y muestra casi todos los colores que puede detectar el ojo humano.

ESPECIFICACIONES

SECCIÓN DEL REPRODUCTOR

iPod/iPhone/iPad

- Modelos de iPod/iPhone/iPad iPod classic compatibles, iPod nano (2ª, 3ª, 4ª, 5ª y 6ª generación), iPod touch (1ª, 2ª, 3ª y 4ª generación), iPhone, iPhone 3G/3GS, iPhone 4, iPad

Formatos de disco y archivo

- Para obtener más información sobre los formatos de disco y archivo compatibles, consulte página 3.

AUX

- Conector de entrada
AUX RCA

SECCIÓN DEL AMPLIFICADOR

- Potencia de salida máxima 30 W + 30 W
(1 kHz, 10% THD, 6 Ω)
- Sensibilidad de entrada/Impedancia de entrada
AUX 400 mV/47 k Ω
- Distorsión armónica total
AUX 1 kHz/10 W 0,05%

SECCIÓN DEL SINTONIZADOR

- Rango de sintonización 87,50 a 108,00 MHz

ENTRADA/SALIDA

- Salida HDMI Conector tipo A \times 1
480i/576i, 480p/576p, 720p, 1080i, 1080p, 1080p/24 Hz,
Compatibilidad con Deep Color, x.v.Color, 3D,
ARC (canal de retorno de audio)
- Salida de vídeo 1 Vp-p (75 Ω)
- Conector USB tipo A \times 2
- Otros equipos Ethernet \times 1

GENERALIDADES

- Fuente de alimentación
[Modelo para Europa] CA 220 – 240 V, 50/60 Hz
[Modelo para Asia] CA 220 – 240 V, 50/60 Hz
[Modelo para Australia] CA 240 V, 50 Hz
[Modelo para Reino Unido] CA 230 V, 50 Hz
[Modelo para China] CA 220 – 240 V, 50/60 Hz
[Modelo para Corea] CA 220 V, 60 Hz
[Modelo para Rusia] CA 220 – 240 V, 50/60 Hz
[Modelo para América Central
y del Sur] CA 100 – 120 V, 50/60 Hz
- Consumo 56 W
- Consumo en estado de espera 0,5 W o menos
- Dimensiones (Ancho \times Alto \times Largo, partes salientes incluidas)
..... 215 \times 114,5 \times 306,3 mm
- Peso 3,0 kg

Las especificaciones están sujetas a cambio sin previo aviso.

■ Propiedad intelectual

- iPad, iPhone, iPod, iPod classic, iPod nano y iPod touch son marcas comerciales de Apple Inc., registradas en EE.UU. y otros países.

“Made for iPod”, “Made for iPhone” y “Made for iPad” significan que un accesorio electrónico se ha diseñado para conectarse específicamente a un iPod, iPhone o iPad, respectivamente, y que el desarrollador ha certificado que cumple con los estándares de rendimiento de Apple. Apple no se hace responsable del funcionamiento de este dispositivo ni de que cumpla con los estándares legales y de seguridad. El uso de este accesorio con un iPod, iPhone o iPad puede tener influencia en el rendimiento de la conexión inalámbrica.

- El material audiovisual puede consistir en productos con propiedad intelectual que no se deben grabar sin la autorización del titular de dicha propiedad intelectual. Remítase a las leyes aplicables en su país.
- Este producto contiene tecnología de protección de copia que está protegida por patentes de EE.UU. y otros derechos de propiedad intelectual. El uso de esta tecnología de protección de copia debe tener la autorización de Rovi Corporation y está pensada para la visualización en casa o en otros entornos restringidos, salvo si Rovi Corporation autoriza expresamente lo contrario. Se prohíbe la ingeniería inversa o el desarmado de la unidad.
- Este producto se otorga con licencia bajo la licencia de cartera de patentes AVC y la licencia de cartera de patentes VC-1 para su uso personal y no comercial por parte de un consumidor para (i) codificar vídeo que cumpla con las normas AVC y VC-1 (“VídeoAVC/VC-1”) y/o (ii) descodificar vídeo AVC/VC-1 codificado por un consumidor dedicado a una actividad personal y no comercial y/o que se obtuvo de un proveedor de vídeo con licencia para proporcionar vídeo AVC/VC-1. No se otorga ni se da por supuesta licencia alguna para cualquier otro uso. Se puede obtener información adicional de MPEG LA, LLC. Consulte <http://www.mpegla.com>.

- Windows Media Player es una marca comercial o una marca comercial registrada de Microsoft Corporation en Estados Unidos y/o en otros países.
- YouTube y el logotipo YouTube son marcas comerciales de Google, Inc.

- **DVD** es una marca comercial de DVD Format/Logo Licensing Corporation.



- Fabricado bajo licencia de Dolby Laboratories. Dolby y el símbolo de la doble D son marcas comerciales de Dolby Laboratories.



- Fabricado con licencia en virtud de las patentes de EE. UU. número: 5,956,674; 5,974,380; 6,226,616; 6,487,535; 7,212,872; 7,333,929; 7,392,195; 7,272,567 y otras patentes de los EE.UU. e internacionales emitidas o pendientes. DTS-HD, su símbolo y DTS-HD y su símbolo son marcas comerciales registradas de DTS, Inc.. El producto comprende también el software. © DTS, Inc. Todos los derechos reservados.



- Blu-ray Disc™, Blu-ray™, Blu-ray 3D™, BD-Live™, BONUSVIEW™ y los logotipos son marcas comerciales de Blu-ray Disc Association.



BONUS VIEW™

- HDMI, el logotipo HDMI y High-Definition Multimedia Interface son marcas comerciales o marcas comerciales registradas de HDMI Licensing LLC.



- “x.v.Color” y el logotipo “x.v.Color” son marcas comerciales.

x.v.Color

- “AVCHD” y el logotipo “AVCHD” son marcas comerciales de Panasonic Corporation y Sony Corporation.



- Java y todas las marcas comerciales y logotipos basados en Java son marcas comerciales o marcas registradas de Sun Microsystems, Inc. en los Estados Unidos y/u otros países.



- DLNA y DLNA CERTIFIED son marcas comerciales y/o marcas de servicio de Digital Living Network Alliance.



- Esta unidad utiliza nuevas tecnologías y algoritmos que permiten obtener un sonido envolvente de cinco canales con solo altavoces frontales y sin necesidad de reflejar los haces en las paredes.



INFORMACIÓN ADICIONAL

Español

注意：在操作本机之前请阅读此部分。

- 1 要确保最好的性能，请仔细阅读此手册。请将它保存在安全的地方以备将来参考。
- 2 请将本声音系统安装在通风良好，凉爽并且干燥，干净的地方 - 应远离直射阳光，热源，振动，灰尘，潮湿和 / 或寒冷的地方。为了使通风良好，请在周围至少留出以下间隙。
顶部：10 cm
背面：10 cm
侧面：10 cm
- 3 请将本机远离其它电子设备、马达或变压器以避免嗡嗡声。
- 4 请勿使本机经受过于从冷到热的突然温度改变，勿将本机放置于高湿度的环境中（例如有加湿器的房间）以防止本机内部发生结露，否则可能导致触电、火灾，损害本机，和 / 或人体伤害。
- 5 请避免在外部物体可能落入本机的地方或本机可能遭遇液体滴落或飞溅的地方安装本机。在本机的顶部，请勿放置：
 - 其它组件机，因为它们可能对本机表面造成损坏和 / 或导致变色。
 - 燃烧物体（例如蜡烛），因为它们可能导致火灾，对本机造成损害和 / 或造成人体伤害。
 - 内部装有液体的容器，因为它们可能会摔落并且液体可能引起用户触电损坏本机。
- 6 为了不阻断热量散发，请勿使用报纸、桌布、窗帘等遮盖本机。如果本机内的温度升高，可能会引起火灾，损坏本机和 / 或导致人体伤害。
- 7 在所有的连接完成之前请勿将本机插头插入墙上插座。
- 8 请勿上下倒置操作本机。它可能过热，并极有可能导致损坏。
- 9 请勿在开关、旋钮和 / 或导线上用力。
- 10 当将电源线从墙上插座断开时，请抓住插头；请勿拖拉导线。
- 11 请勿使用化学溶剂清洁本机；这可能损坏机壳涂层。请使用洁净的干布。
- 12 只能使用本机规定的电压。在本机上使用比规定值高的电压是危险的并可能导致火灾，损坏本机和 / 或造成人体伤害。Yamaha 将不对由于在本机上使用非规定电压而造成的任何损害负责。
- 13 为了避免雷击造成损坏，在雷电期间，将电源导线从墙壁上的电源插座拔下，也将天线从本机上拔下。
- 14 请勿尝试修改或修理本机。当需要任何维修时请联系专业 Yamaha 维修人员。不能以任何理由打开机壳。
- 15 当准备长时间（例如休假）不使用本机时，请将交流电源线从墙上插座断开。
- 16 对通常的操作错误，在断定本机出故障之前，请务必先阅读“故障排除”一节。
- 17 在搬动本机之前，请按  以将本机设置为待机模式，并将交流电源插头从墙上插座断开。
- 18 如果环境温度剧烈变化，就可能形成结露。从插座上拔下电源插头，将本机搁置一旁。
- 19 长时间使用本机后，本机可能变热。将电源关闭，将本机搁置冷却。
- 20 将本机靠近交流电源插座安装以便交流电源的接插。

- 21 电池不能置于高热环境，比如火或直射日光等。
- 22 来自耳塞式耳机和双耳式耳机的额外声压也许会损害听力。

只要本机连接在墙壁的交流电源插座上，即使按下  按钮后本机自身被关闭，本机也没有从交流电源断开。这种状态被称为待机模式。在此状态下，本机消耗很小一部分电力。

警告

要减少火灾或触电的危险，请勿将本机暴露于雨中或湿气中。

激光安全

本机使用激光。因为可能会伤害眼睛，仅可由具有资格的维修人员拆卸罩盖或试图对本装置进行维修服务。

危险

打开本机时，机器会放出可见激光射线。为了避免光束直接照射到眼睛上，在插上本机的交流电源时，不要将眼睛对着打开的托盘或者其他打开着的装置，并且不要往装置内部窥视。

警告

请勿在本机连续以高音量使用时触摸本机，因为本机底部会变热。可能会导致烫伤等伤害。

目录

简介

本机的功能	2
附件	2
关于碟片和文件	3
本机可使用的碟片 / 文件类型	3
装入碟片	4
碟片注意事项	4
观看 3D 视频图像注意事项	4
前面板和基本操作	5
遥控器	6
安装遥控器电池	9
使用遥控器	9

准备工作

连接	10
将组件系统连接到本机	10
其它连接	11
连接到电视机	12
HDMI 连接	12
视频连接	12
网络和 USB 连接	13
连接到 NETWORK 端子	13
连接到 USB 端口	13

操作

初始向导 / 简易设置	14
用初始向导 / 简易设置进行设置	14
基本操作	15
使用 HOME/MEDIA 菜单的基本操作	15
播放图片 / 音乐 / 视频	16
使用网络内容	18
不使用 HOME/MEDIA 菜单的基本操作	19
iPod 操作	20
CD 操作	20
高级播放操作	21
屏幕菜单	21
状态菜单	22
使用书签	23
编程播放	23
使用搜索	24
欣赏 BONUSVIEW™ 和 BD-Live™	24
聆听 FM 无线电台	26
调到无线电台	26
预设无线电台	26
选择预设无线电台 (预设调谐)	26
使用实用功能	27
使用前面板显示屏上的选项菜单	27
设定时钟 / 定时器和睡眠定时器	28
通过电视机遥控器操作本机 (HDMI 控制功能)	29

设定

设置菜单	31
设置菜单操作	33
通用设置	34
显示设定	36
音频设定	38
关于视频输出格式	39
软件升级	40
升级软件	40

附加信息

故障排除	41
常规	41
无线电接收	42
iPod	43
USB	44
碟片播放	44
遥控器	46
网络	46
画面上的信息	47
其他	47
术语表	48
规格	50

■ 关于本说明书

- 本说明书介绍当遥控器可用时如何使用遥控器操作本机。某些操作也可以使用前面板按钮进行。
- 注意事项中包含有关安全和操作说明的重要信息。
✦ 表示操作提示。
- 本说明书中所述的“iPod”也可能是指“iPhone”或“iPad”。
- 本说明书于产品生产前印刷。设计和规格由于改进等原因会有部分改变。如果说明书和产品之间有差异,则以产品为准。

本手册中使用的图标

图标用于以特殊格式表示可用按钮 / 功能。

- BD**: BD 视频
- DVD**: DVD 视频、DVD-VR、DVD+VR
- CD**: 音频 CD
- VIDEO**: AVCHD, WMV
- MUSIC**: MP3, WMA, WAV
- PHOTO**: JPEG

本机的功能

播放市售 Blu-ray Disc™/DVD/CD*1 → 第 21 页

除 Blu-ray Disc™ (BD 碟片) 之外, 本机还支持其他各种碟片的播放。

播放 BONUSVIEW™、BD-Live™ 等 *1 → 第 24 页

可欣赏最新 BD 碟片上的电影花絮。

播放碟片 /USB 存储设备 /iPod/iPhone/iPad 上的视频、音乐、图片文件 *1 → 第 15 页

用本机可播放碟片 /USB 存储设备 /iPod/iPhone/iPad 上记录的文件。

播放家庭网络服务器上的视频、音乐、图片文件 *1,2 → 第 18 页

通过将本机连接到网络服务器可用电视机播放电脑内容。

接收 FM 无线电台 → 第 26 页

您可以用本机收听 FM 无线电台。

执行初始向导 / 简易设置 → 第 14 页

可通过初始向导 / 简易设置画面轻松设定语言、分辨率和画面纵横比。

用电视机遥控器操作 → 第 29 页

通过用 HDMI 电缆连接设备, 可使用 HDMI 控制功能用一个遥控器控制多个设备。

通过 AIR SURROUND XTREME 播放高质量虚拟环绕声 → 第 16 页

可享受 Yamaha 独有的再现高质量虚拟环绕声的 AIR SURROUND XTREME。

*1 有关可播放碟片和文件的详细说明, 请参阅第 3 页。

*2 使用此功能需要网络设定。

附件

确认以下物品是否齐全。

遥控器



电池 (× 2)
(AAA, R03, UM-4)

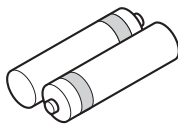

室内 FM 天线 *3

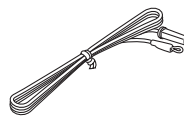

复合视频电缆 (1.5 m)

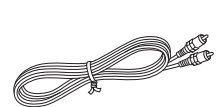









*3 附送的室内 FM 天线因机型而异。

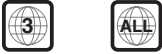

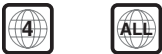

关于碟片和文件

本机可使用的碟片 / 文件类型

- 本机可播放 12 cm 和 8 cm 碟片。请勿使用 8 cm 至 12 cm 适配器。
- 使用符合碟片标签上官方标志所示的兼容标准的碟片。不保证可以播放不符合这些标准的碟片。此外，即使可播放这些碟片，也不保证图像质量或声音质量。

碟片类型	录制格式	数据格式
BD-ROM/BD-R/BD-RE	BD 视频	--
DVD-ROM	DVD 视频	--
DVD-R/DVD-R DL/ DVD-RW	DVD 视频 / DVD-VR/ AVCHD / 数据碟片	WMV/MP3/WAV/WMA/ JPEG
DVD+R/DVD+R DL/ DVD+RW	DVD 视频 / DVD+VR/ AVCHD / 数据碟片	WMV/MP3/WAV/WMA/ JPEG
CD-ROM	CDDA/HDCD	--
CD-R/CD-RW	CDDA / 数据碟片	WMV/MP3/WAV/WMA/ JPEG
USB	--	WMV/MP3/WAV/WMA/ JPEG
网络	--	WMV/MP3/WMA/WAV/ JPEG

区域管理信息		
目的地	BD 视频	DVD 视频
亚洲	区码 "A" 或 "ALL" 	区码 "3" 或 "ALL" 
中美洲和南美洲	区码 "A" 或 "ALL" 	区码 "4" 或 "ALL" 
韩国	区码 "A" 或 "ALL" 	区码 "3" 或 "ALL" 
欧洲	区码 "B" 或 "ALL" 	区码 "2" 或 "ALL" 
澳大利亚	区码 "B" 或 "ALL" 	区码 "4" 或 "ALL" 

区域管理信息		
目的地	BD 视频	DVD 视频
俄罗斯	区码 "C" 或 "ALL" 	区码 "5" 或 "ALL" 
中国	区码 "C" 或 "ALL" 	区码 "6" 或 "ALL" 

- BD/DVD 视频播放器和碟片具有区码，表示碟片可播放的区域。
- BD/DVD 视频操作和功能可能与本说明书中的说明有差异，并且由于碟片制造商的设置，可能禁止某些操作。
- 如果在碟片播放过程中显示菜单画面或操作说明，请遵照所显示的操作步骤。

注意

- 视碟片而定，可能无法播放左侧列表中的某些碟片。
- 最终化本机中播放的所有录制媒体。
- “最终化”是指录像机处理录制的碟片以便能在其他播放器 / 录像机以及本机上播放。只有经最终化的碟片才能在本机上播放。（本机不具有最终化碟片的功能。）
- 不保证可以播放碟片、USB 存储设备和网络上的所有文件。
- 无法通过 USB 存储设备和网络播放受版权保护的文件。

MP3/WMA 音频文件要求

- 采样频率：32 - 48 kHz 以内（MP3/WMA），LPCM 44.1 kHz/16 比特 / 立体声（WAV）
- 比特率：8 - 320 kbps（MP3）、32 - 192 kbps（WMA）以内

WMV 文件要求

- WMV9，最大分辨率为 1920 × 1080。

装入碟片

- 标签面朝上插入碟片。
- 如果碟片为双面录制，则播放面朝下。

注意

- 视碟片和本机的设定而定，可能会自动开始播放。
- 视碟片而定，可能首先显示菜单。
- 视碟片而定，碟片载入时间可能不同。

碟片注意事项

- 请勿触碰碟片表面。持拿碟片边缘（和中心孔）。
- 请勿使用铅笔或记号笔在碟片上书写。
- 请勿将胶带、封条、胶水等粘在碟片上。
- 请勿使用保护盖以防刮伤。
- 请勿一次将一张以上碟片装入本机。否则会造成本机和碟片损坏。
- 请勿将任何异物插入碟片插槽。
- 请勿装入破裂、弯曲或粘有胶水的碟片。
- 请勿将碟片暴露于直射阳光、高温、高湿或多尘环境。

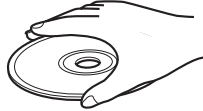

注意

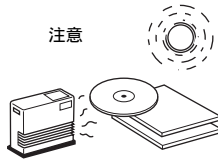

- 如果碟片变脏，请用干净的干布从中心向外缘擦拭。请勿使用唱片清洁剂或油漆稀释剂。
- 为避免故障，请勿使用市售的激光头清洁剂。

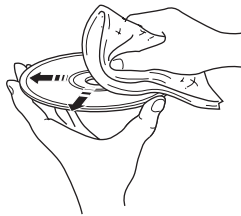

观看 3D 视频图像注意事项

- 有些人观看 3D 视频图像时可能会出现不适（如眼睛疲劳、疲乏或恶心）。建议所有的观众在观看 3D 视频图像期间定时休息。
- 如果您出现任何不适，请停止观看 3D 视频图像，直至不适症状消退。如果出现严重的不适请及时就医。
- 请仔细阅读（BD 碟片和电视机）使用说明书和 / 或电视机上出现的注意信息。
- 儿童（尤其是六岁以下的儿童）的视力仍在发育。让儿童观看 3D 视频图像前，请咨询您的医生（如儿科医生或眼科医生）。
- 成人应监督儿童，确保他们遵循上述建议。

前面板和基本操作

-  本机具有自动待机功能。
- 当源设定为碟片 /USB/ 网络时，在本机处于开机状态下如果 1 小时未进行播放或任何其它操作，本机将自动切换为待机模式。
 - 当源未设定为碟片 /USB/ 网络时，在本机处于开机状态下如果 1 至 8 小时未进行播放或任何其它操作，本机将根据设置菜单（第 34 页）中的设定自动切换为待机模式。

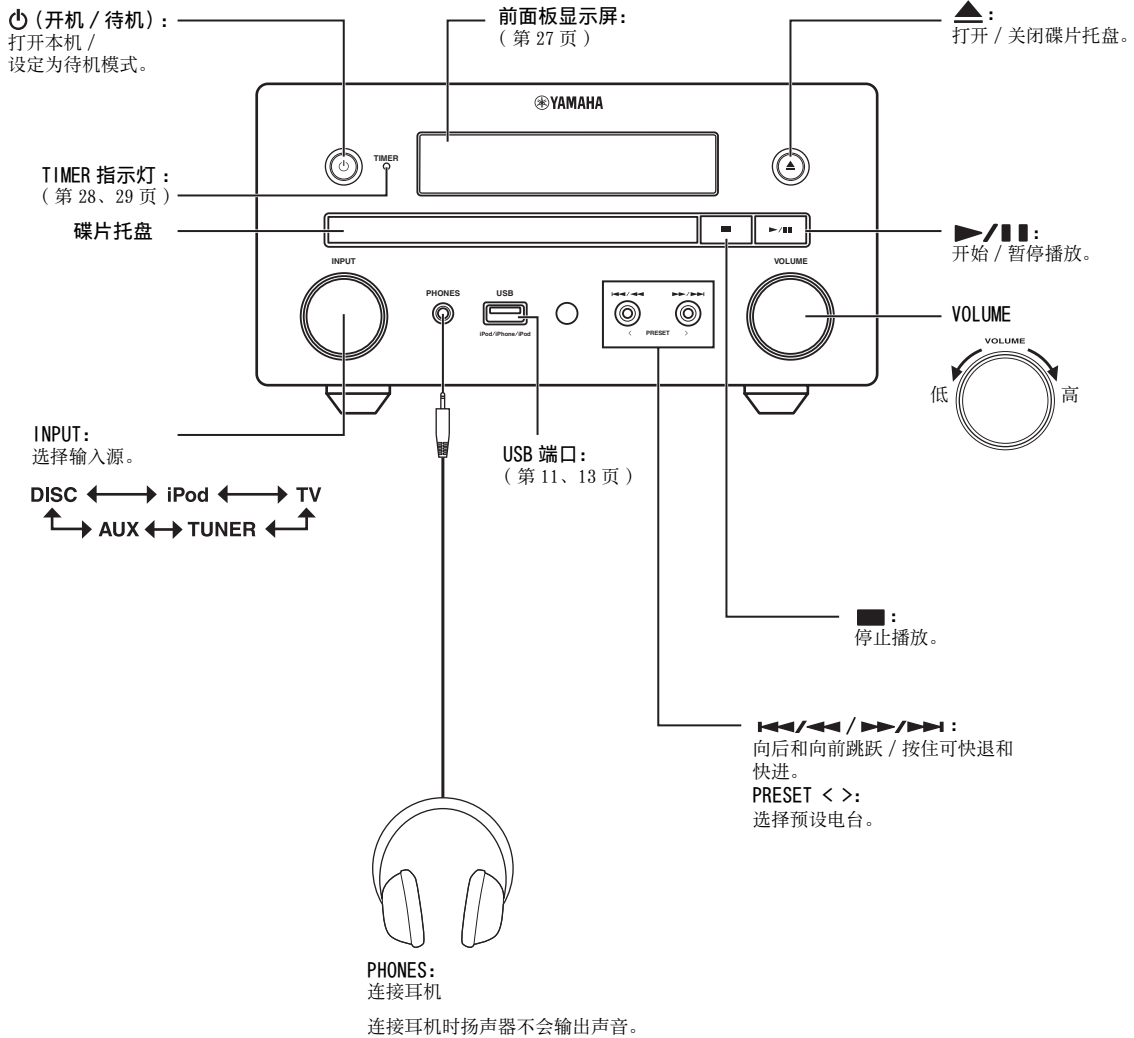







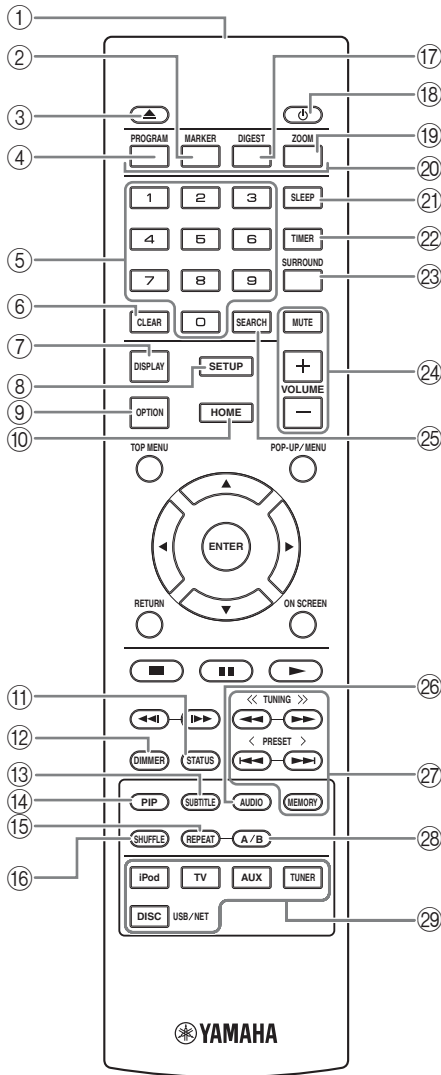



遥控器

注意

如果按下的按钮不可使用，画面的左上角会出现 。



- ① 红外线信号发射器（第 9 页）
 - ② **MARKER DVD VIDEO**：在电影的指定点设定书签（第 23 页）。书签设定后，请按下 **DIGEST** 选择想要跳到的设定点。最多可设定 12 个书签。
 - ③ ：打开 / 关闭碟片托盘。
 - ④ **PROGRAM DVD CD**：设定播放顺序（第 23 页）。最多可设定音频碟片的 15 个曲目或 DVD 视频碟片的 15 个标题 / 章节。
 - ⑤ **数字按钮**：输入数字，或播放时跳到与所输入数字对应的曲目 / 章节。根据碟片类型和播放条件的不同，这些按钮可能不可用。
 - ⑥ **CLEAR**：清除输入的数字 / 设定的项目。
 - ⑦ **DISPLAY**：切换前面板显示屏上显示的信息（第 20 页）。
 - ⑧ **SETUP**：显示设置菜单画面（第 31 页）。
 - ⑨ **OPTION**：进入选项菜单模式（第 27 页）。
 - ⑩ **HOME**：显示 HOME 菜单画面（第 16 页）。
 - ⑪ **STATUS**：显示画面上的播放信息（第 22 页）。
 - ⑫ **DIMMER**：改变前面板显示屏的亮度。通过反复按此按钮，在亮或暗之间选择亮度。
 - ⑬ **SUBTITLE BD DVD VIDEO**：若有多个字幕语言，则可更改（第 49 页）。也可从屏幕菜单选择此项目（第 21 页）。
 - ⑭ **PIP BD**：打开 / 关闭画中画（第 24 页）。当此功能可用时，画面上显示画中画标记（）。也可从屏幕菜单选择此项目（第 21 页）。
- 注意**
- 只有当 [画中画标记] 设定为 [开] 时，才会显示画中画标记（第 35 页）。
- ⑮ **REPEAT BD DVD CD VIDEO MUSIC PHOTO**：选择重复模式。每按一次按钮，将如下更改重复模式（第 20、22 页）。
 - ：重复正在播放的标题。
 - ：重复正在播放的章节。
 - ：重复正在播放的文件夹。
 - ：重复碟片 / 文件夹中的所有曲目 / 文件。
 - ：重复正在播放的曲目 / 文件。
 - ⑯ **SHUFFLE DVD CD VIDEO MUSIC PHOTO**：选择乱序播放模式（第 20、21 页）。
 - ⑰ **DIGEST PHOTO**：显示 12 张图片缩略图。显示缩略图时，可用  /  进入下一 / 上一页面。
DVD VIDEO：显示书签选择条（第 23 页）。
 - ⑱ ：打开本机或将其设定为待机模式。

- ①9 ZOOM **DVD** **VIDEO** **PHOTO**: 放大 / 缩小。每按一次按钮, 画面尺寸将改变 (放大 / 缩小: 各 3 级)。
- ②0 彩色按钮 **BD**: 根据画面上的说明使用这些按钮。
- ②1 SLEEP: 设定为睡眠模式 (第 29 页)。
- ②2 TIMER: 设定为定时器模式 (第 28 页)。
- ②3 SURROUND: 打开 / 关闭扬声器的环绕播放模式 (第 16 页)。(不影响耳机声音。)
- ②4 音量控制按钮: 控制音量 (第 16 页)。按 MUTE 关闭音量。再次按将恢复音量。
- ②5 SEARCH **BD** **DVD** **CD** **VIDEO** **MUSIC**: 播放过程中跳到指定点。有关此功能的详细说明, 请参阅“使用搜索”(第 24 页)。也可从状态菜单选择此项目 (第 22 页)。
- ②6 AUDIO **BD** **DVD**: 更改音频语言或格式。也可从屏幕菜单选择 (第 21 页)。
- ②7 FM 控制按钮
TUNING << / >>: 开始手动调谐。按住将开始自动调谐 (第 26 页)。
PRESET < / >: 选择预设电台 (第 26 页)。
MEMORY: 开始预设调谐和保存预设电台 (第 26 页)。
- ②8 A/B **BD** **DVD** **CD** **VIDEO** **MUSIC**: 播放想要重复的指定部分。
 - 1 在想要设定起点的场景中按 A/B。画面上显示 [A-]。
 - 2 在想要设定终点的场景中再次按 A/B。画面上显示 [A-B]。
开始重复播放。
 - 3 若要取消重复播放, 请按 A/B。[A-B] 消失且重复播放结束。

注意

视碟片的规格而定, 可能无法执行此功能。

- ②9 输入选择按钮: 选择输入源 (第 15、19、26 页)。

接下页。 →

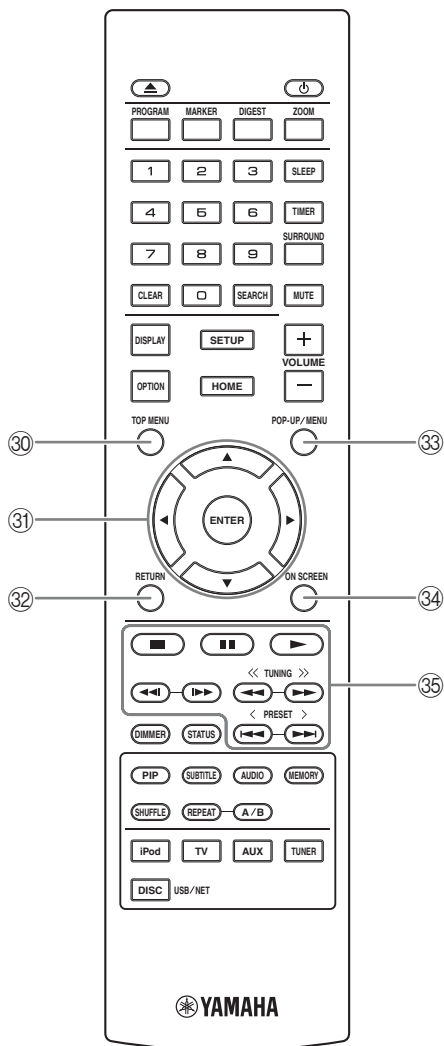

- ③① TOP MENU **BD DVD**: 如果碟片包含菜单，则显示顶部菜单画面（第 49 页）。使用 ▲/▼/◀/▶ 和 ENTER 选择所需项目。

注意

具体操作可能视碟片而异。请按照各菜单画面的说明进行操作。

- ③② 光标按钮 (▲/▼/◀/▶): 移动以选择突出的项目。ENTER: 确认突出的菜单 / 项目。
- ③③ RETURN: 返回上一个菜单或画面等。
- ③④ POP-UP/MENU **BD DVD**: 显示弹出菜单。显示的菜单内容因碟片而异。有关如何查看和操作弹出菜单的详细说明，请参阅碟片的说明书。视碟片而定，通过按 POP-UP/MENU 可能会显示顶部菜单画面。
- ③⑤ ON SCREEN: 显示屏幕菜单（第 21 页）。

控制按钮

BD DVD CD VIDEO MUSIC PHOTO :

- ▶: 播放内容。
- : 停止播放。若要完全停止播放，请按两下此按钮。
- : 暂停播放。

BD DVD CD VIDEO MUSIC :

- ◀◀ / ▶▶: 向后 / 向前跳跃。
- ◀◀ / ▶▶: 按下可即时搜索 / 重播。即时搜索跳过 30 秒内容。即时重播重播 10 秒前的内容。

BD DVD CD VIDEO MUSIC :

- ◀◀ / ▶▶: 向后 / 向前搜索。每按一次按钮，搜索速度将更改（向后 / 向前搜索：各 5 级）。按 ▶ 可恢复正常播放。

PHOTO :

- ◀◀ / ▶▶: 更改幻灯片的的速度（减慢 / 加快：3 级）。

注意

视碟片而定，本机从本机之前停止的点继续播放。若要从头开始播放，请按 ■，然后按 ▶。

安装遥控器电池

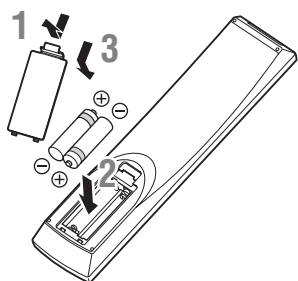

■ 关于电池的注意事项

- 当遥控器的操作范围缩小时，请同时更换 2 节电池。
- 使用 AAA、R03、UM-4 电池。
- 请确保极性正确。请参考电池舱中的图示。
- 如果长时间不使用遥控器，请取出电池。
- 请勿混用新旧电池。
- 请勿混用不同类型的电池（例如碱性电池和锰电池）。因为这些类型不同的电池的形状和颜色可能相同，所以请仔细阅读包装上的说明。
- 如果电池漏液，请立即丢弃。请勿触摸漏出的液体，也不要让其接触衣物等。安装新电池以前，请彻底清洁电池舱。
- 请勿将电池与普通家庭垃圾一起丢弃；请根据当地法规正确丢弃。
- 将电池远离儿童放置。如果误吞电池，请立即就医。
- 长期不打算使用遥控器时，请从遥控器中取出电池。
- 请勿对附送的电池充电或进行拆解。

使用遥控器

遥控器发射具有方向性的红外光束。请务必在操作期间将遥控器直接对着本机前面板上的遥控感应器。

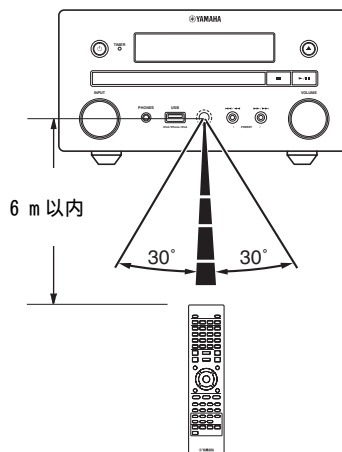

注意

- 遥控器和本机之间不能有任何大型障碍物。
- 切勿将水或其它液体溅到本遥控器上。
- 切勿失手跌落遥控器。
- 切勿在以下场所搁置或存放遥控器：
 - 高湿度，例如浴室附近
 - 高温，例如加热器或炉子附近
 - 极低温度
 - 多尘的地方。
- 切勿让遥控感应器受到强光照射，尤其是变频荧光灯；否则遥控器可能无法正常工作。如果需要，请让系统避免受到直接光照。

连接

将组件系统连接到本机

连接系统以前，请务必阅读以下步骤并仔细记录。

■ 连接系统

- 1 通过扬声器组件（NS-BP150）附送的扬声器电缆，将本机的扬声器端子（L）连接到左扬声器的扬声器端子，将本机的扬声器端子（R）连接到右扬声器的扬声器端子。
- 2 将附送的 FM 天线连接到 FM 插孔。

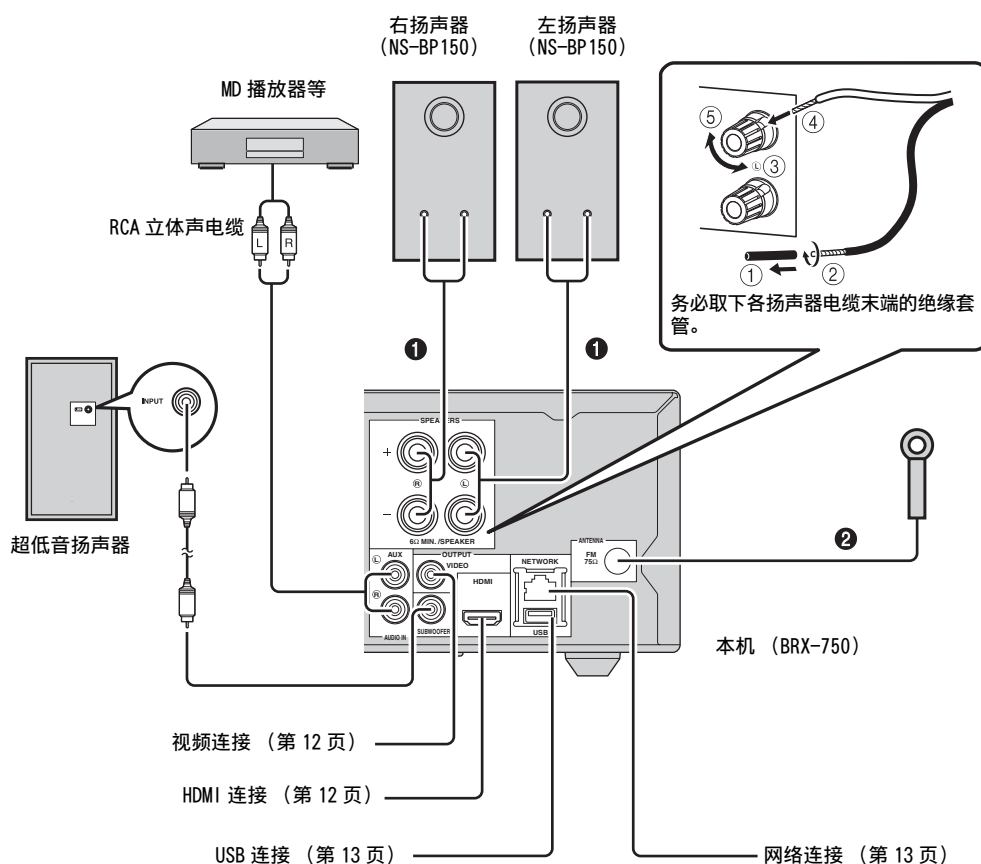

注意

- 完成所有设备之间的连接以前，切勿将本机或其它组件连接到总电源。
- 切勿让裸露的扬声器导线互相接触或接触到本机的任何金属部分。否则可能损坏本机 and / 或扬声器。
- 必须正确进行所有连接：L（左）到 L，R（右）到 R，“+”到“+”，“-”到“-”。如果连接错误，则扬声器将不发出声音，并且如果扬声器连接的极性不正确，则声音将不自然且缺少低音。另外，请参阅各组件的使用说明书。

注意

- 连接 NS-BP150 以外的扬声器时，请使用阻抗大于 6 Ω 的扬声器。
- 如果您所在的地区无线电波接收不佳，或者您想改善无线接收，建议您使用市售的室外天线。详细说明，请咨询附近授权的 Yamaha 经销商或服务中心。

其它连接**■ 连接 iPod**

通过将 iPod 连接到本机，可欣赏存储在其中的音乐。

注意

本机兼容 iPod classic、iPod nano（第 2 代、第 3 代、第 4 代、第 5 代和第 6 代）、iPod touch（第 1 代、第 2 代、第 3 代和第 4 代）、iPhone、iPhone 3G/3GS、iPhone 4 和 iPad。

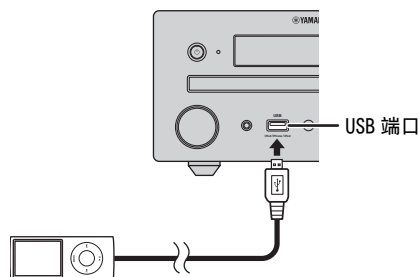
**注意**

- 确保 iPod 和本机之间的 USB 电缆牢固连接。
- 将 iPod 连接到本机的前 USB 端口。后 USB 端口不兼容 iPod。

■ 连接电源线

进行所有连接以后，连接本机的电源线。

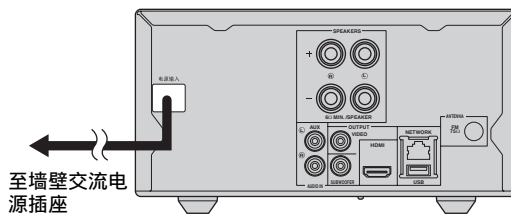

连接到电视机

务必仔细阅读以下图示，以便正确进行本机和电视机之间的连接。

注意

请在所有连接完成之后，再连接本机的电源线。

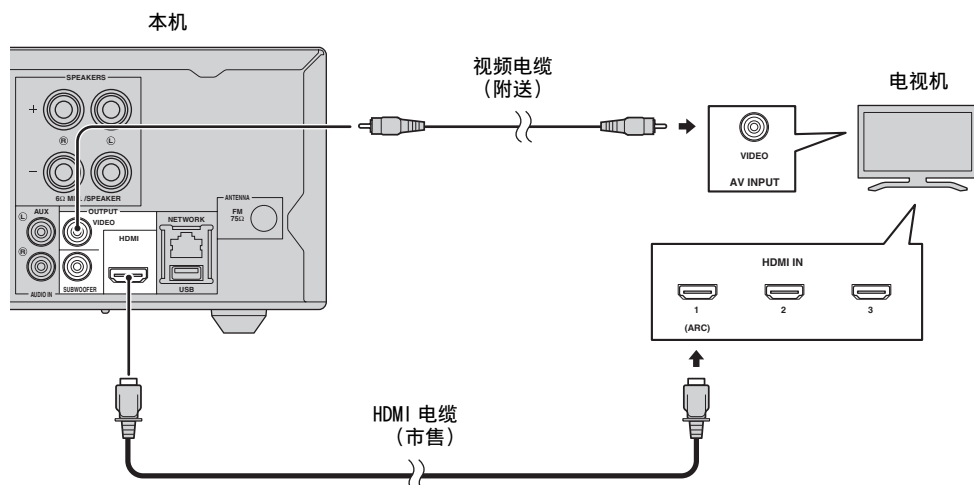

HDMI 连接

- 可通过 HDMI 端子欣赏高质量数字图像和声音。
- 将 HDMI 电缆（市售）牢固连接到本机的 HDMI 端子。
- 使用具有 HDMI 标志的 HIGH SPEED HDMI 电缆（第 51 页）。



- 使用 HDMI 控制功能时，请参阅“通过电视机遥控器操作本机（HDMI 控制功能）”（第 29 页）和“[HDMI 控制]”（第 34 页）。
- 有关 HDMI 端子输出模式的信息，请参阅“[HDMI]”（第 38 页）。
- 如果未显示图像，请参阅“故障排除”（第 41 页）。

■ 播放 Blu-ray 3D 碟片所需的连接

需要以下设备和连接才能在本机上欣赏 BD 3D 碟片：

- 具有 3D 功能的电视机。
- 电视机和本机必须使用 HDMI 电缆连接。
- BD 碟片应包含 3D 图像。

■ 关于支持音频回传通道（ARC）的电视机

- 可将 HDMI 电缆连接到电视机上支持音频回传通道的端子（标有“ARC”的端子）。
- 需要激活本机的 HDMI 控制功能才能激活音频回传通道（ARC）（第 34 页）。

什么是音频回传通道（ARC）？

本功能可通过 HDMI 电缆将数字音频信号从电视机输出到本机，而无需使用数字音频插脚电缆。



如果电视机不支持 ARC，请通过本机的 AUX 插孔连接电视机和本机。

视频连接

- 将复合视频电缆（附送）牢固连接到 VIDEO 插孔。
- 有关视频输出格式的信息，请参阅第 39 页。

注意

- 如果通过录像机播放图像，由于复制保护功能，图像可能会劣化。
- 若要欣赏本机上的 BD 3D 碟片，则需要使用 HDMI 电缆（市售）连接电视机和本机。

网络和 USB 连接

连接到 NETWORK 端子

- 通过将本机连接到网络可播放电脑内容。
- 播放 BD-Live 兼容碟片时，通过连接到互联网可欣赏具有互动功能的各种内容。有关 BD-Live 功能的信息，请参阅第 24 页。

注意

- 将网线（市售）牢固连接到 NETWORK 端子。
- 仅使用 STP（屏蔽双绞线）网线。
- 使用互联网时，需要如下所示进行宽带互联网连接。
- 将网线的其他连接器连接到集线器 / 宽带路由器。
- 使用宽带互联网连接时，需要与互联网服务提供商签订合同。有关更多详情，请联系附近的互联网服务提供商。
- 由于所连接设备和连接方法可能因互联网环境而异，请参阅您设备的使用说明书。
- 使用支持 10BASE-T/100BASE-TX 的网线 / 路由器。

连接到 USB 端口

- 可将 BD 本地存储的 USB 存储设备（2 GB 或更大且以 FAT 32/16 格式化）连接到本机后面板（或前面板）上的 USB 端口，以保存 BD-Live 数据（第 25 页）或升级本机的软件（第 40 页）。
- 将 USB 存储设备（市售）牢固连接到 USB 端口。

注意

- 执行 BD-Live 或软件升级的操作时，请勿取下 USB 存储设备或拔掉电源线。
- 将 USB 存储设备连接到本机的 USB 端口时，请勿使用 USB 延长线。使用 USB 延长线可能会妨碍本机正确工作。

注意

- Yamaha 不保证本机可与所有品牌的 USB 存储设备配合操作。
- 有关使用 USB 存储设备的更多注意事项，请参阅第 15 页。

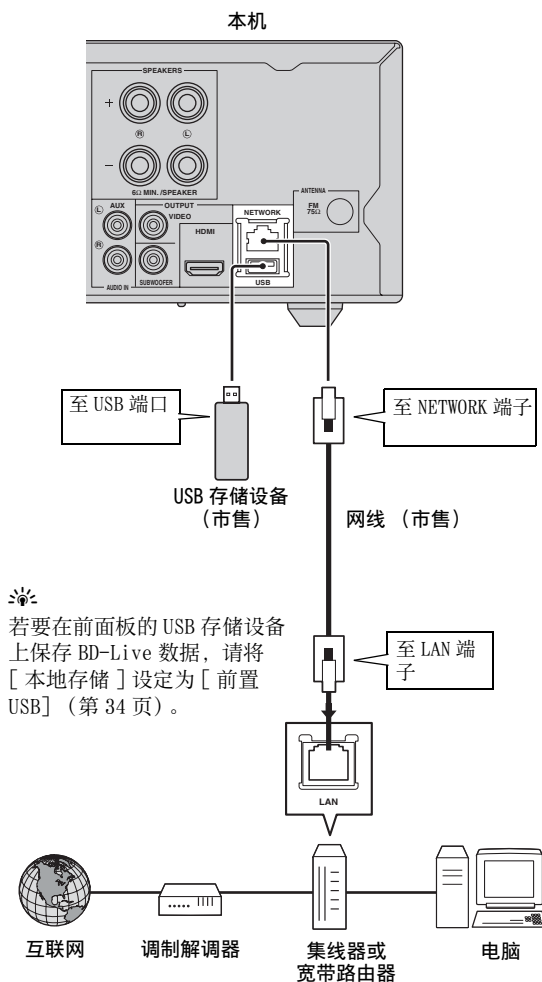

■ 连接后

- 手动设定网络设定时，请参阅“网络”（第 35 页）。
- 若要播放网络上的电脑内容，请参阅“使用网络内容”（第 18 页）。

初始向导 / 简易设置

用初始向导 / 简易设置进行设置

初始向导 / 简易设置可轻松设定语言、分辨率和画面纵横比。购买或升级后首次打开本机时会显示初始向导画面。可从设置菜单 → [系统] → [简易设置] 中执行相同的设定（第 31 页）。

1 显示简易设置画面时，按 ENTER 开始简易设置。



2 按 ▲/▼ 选择想要在画面上显示的语言，然后按 ENTER。



3 按 ▲/▼ 选择分辨率，然后按 ENTER。有关设定项目的详细说明，请参阅“[视频输出选择]”（第 36 页）。

注意

当通过 VIDEO 插孔连接电视机和本机时，请选择 [模拟视频]。



4 按 ▲/▼ 选择画面纵横比，然后按 ENTER。有关设定项目的详细说明，请参阅“[电视屏幕]”（第 36 页）。简易设置完成。



5 按 ENTER 退出简易设置。

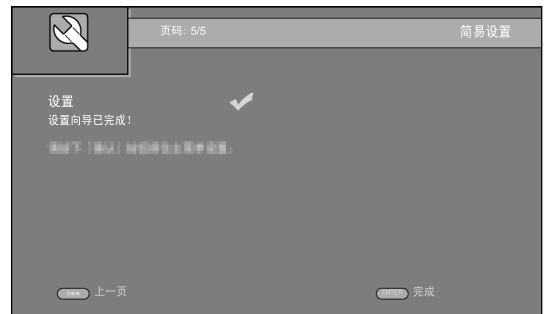

注意







- 初始向导 / 简易设置完成后如果未显示图像，请参阅“故障排除”（第 41 页）。
- 打开本机时，会出现关于 3D 视频播放的警告信息。按 ENTER 取消信息或按 CLEAR 将其停用（第 34 页）。

基本操作

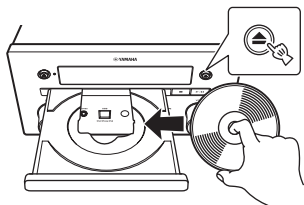
☀
当源为 CD/iPod/FM/ 电视机时，请参阅“不使用 HOME/MEDIA 菜单的基本操作”（第 19 页）。当源为 BD/DVD/USB/ 网络时，请阅读以下内容（也可通过 HOME/MEDIA 菜单播放 CD）。

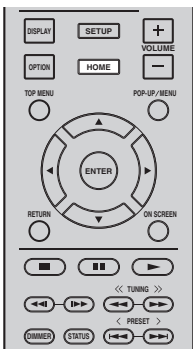
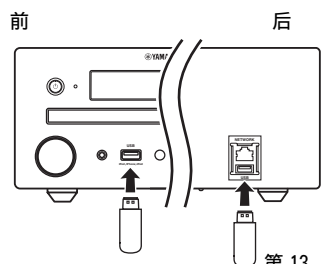
使用 HOME/MEDIA 菜单的基本操作

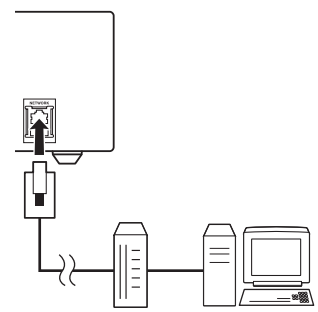
按照以下步骤播放源。

	1 放置源	2 切换输入	3 参阅以下页面获得更多操作信息
碟片	 <p>第 16 页</p>		
USB*1	 <p>第 13、16 页</p>		
网络 (电脑内容)	 <p>第 13、18 页</p>		

- *1
- 某些设备即使符合要求也可能工作不正常。
 - 不保证可以播放所有类型的 USB 设备以及对其进行供电。
 - 视文件 / 文件夹数量而定，读取时间可能超过 30 秒。
 - Yamaha 及其供应商对于连接到本机的 USB 设备上保存数据的丢失不承担任何责任。作为预防措施，建议对文件进行备份。

■ 控制音量

- 1 按遥控器上的音量控制按钮 (+/-) 调高 / 降低音量 (第 7 页)。

■ 打开 / 关闭环绕播放模式

- 1 按 SURROUND 打开 / 关闭环绕播放模式 (第 7 页)。设定为开时:
 - 如果源为 BD 等环绕播放源, 则使用 Yamaha 独有的 AIR SURROUND XTREME (第 48 页) 播放环绕声。
 - 如果源为音频 CD 等立体声播放源, 则再现更加宽广的立体声。

播放图片 / 音乐 / 视频

HOME 和 MEDIA 菜单可浏览和播放数据碟片、USB 存储设备和网络上的多媒体文件。

注意

有关可播放碟片和文件的详细说明, 请参阅第 3 页。

■ 基本操作

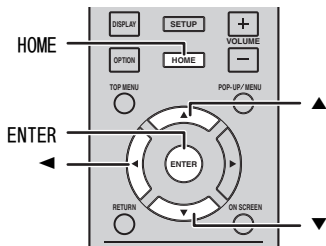

▲ / ▼: 移动突出项目。

◀: 返回父文件夹。

HOME: 移动到 / 退出 HOME 菜单画面。

ENTER: 确认文件夹 / 文件。

■ MEDIA 菜单顶部上的图标

: 播放托盘上的碟片, 或显示数据碟片中的内容。

: 显示连接到 USB 端口的 USB 存储设备中的内容。

: 搜索网络上的 DLNA (第 18 页) 服务器。

: 显示所连接 DLNA 服务器上的内容。

■ 播放所选文件夹中文件的共同操作

示例: 选择 USB 存储设备上的电影文件

注意

移动到 MEDIA 菜单画面之前, 请停止播放视频。

- 1 按 HOME 移动到 HOME 菜单画面。

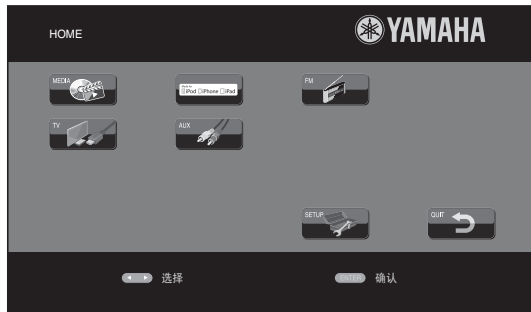

HOME 菜单画面可能因机型而异。

- 2 按 ◀ / ▶ / ▲ 选择 [MEDIA], 然后按 ENTER。MEDIA 画面显示。



- 3 选择包含想要播放的文件的项目, 然后按 ENTER。



- 4 选择想要播放的图片、音乐、视频或 AVCHD 文件夹，然后按 **ENTER**。
若要返回父文件夹，请按 **←** 或选择 。



注意

请注意，以下步骤中仅显示此步骤中所选择的文件类型。例如，如果在此步骤中选择了图片文件夹，则此步骤之后仅显示图片文件。想要播放图片以外的文件时，请返回此步骤并重新选择文件类型。

- 5 选择包含想要播放的文件的文件夹。

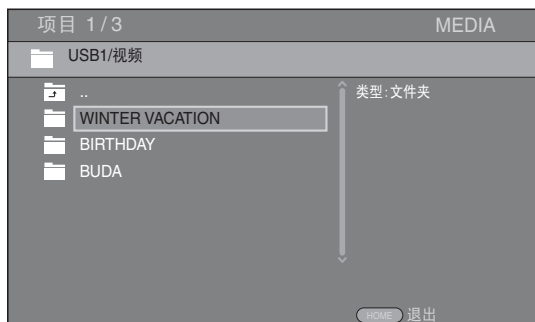

- 6 选择想要播放的文件，然后按 **ENTER**。
选择了视频文件时，播放开始。
选择了音乐文件时，显示状态菜单且播放开始。
选择了图片文件时，开始播放幻灯片。

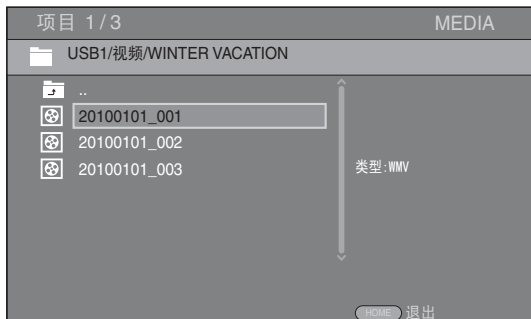

若要带音乐欣赏幻灯片，请在播放音乐的同时按 **HOME** 返回 **HOME** 菜单画面，然后选择图片文件。

注意

视内容而定，可能无法播放显示的文件。

■ 观看图片的操作

观看图片时，遥控器上的按钮如下工作。

- : 停止幻灯片播放并返回文件浏览器。
- ■ : 暂停幻灯片播放。
- ▶ : 播放幻灯片。
- ▶▶: 移动到下一张图片。
- ◀◀: 移动到上一张图片。
- ▶▶▶: 以 3 级速度加快幻灯片播放。
- ◀◀◀: 以 3 级速度减慢幻灯片播放。
- ▲ : 反转图片。
- ▼ : 映出图片。
- ◀ : 逆时针旋转图片。
- ▶ : 顺时针旋转图片。

ZOOM: 放大 / 缩小图片 (放大 / 缩小: 各 3 级)。

▲ / ▼ / ◀ / ▶: 当图片比屏幕大时以变焦模式移镜头。

DIGEST: 切换到缩略图模式 (第 6 页)。显示缩略图时，可用 ◀◀◀ / ▶▶▶ 进入下一 / 上一页面。

使用网络内容

■ 关于 DLNA

本机为 DLNA 认证的数字媒体播放器。可以管理存储在家庭网络的 DLNA 服务器上的图片、音乐和视频内容。

DLNA (Digital Living Network Alliance) 通过家庭网络轻松共享数字媒体，您可以通过本机用电视机欣赏存储在安装 DLNA 服务器软件的电脑或其他 DLNA 兼容设备上的数字内容。若要将本机连接到 DLNA 服务器，需要进行 DLNA 服务器或设备的某些设定。详细说明，请参阅 DLNA 服务器软件或 DLNA 设备。

■ 播放共享的内容

注意

若要在电脑上播放文件，请安装 DLNA 服务器软件，如 Windows Media Player 12，并共享要播放的文件。

1 打开安装有 DLNA 服务器软件的电脑或连接到家庭网络的 DLNA 设备。

2 按 HOME 显示 HOME 菜单画面，然后选择 [MEDIA] 移动到 MEDIA 菜单。
画面上列出连接到网络的 DLNA 服务器。



注意

- 如果未列出 DLNA 服务器，请选择 [DLNA 搜索] 进行查找。
- 视 DLNA 服务器而定，本机可能需要从服务器获得许可。
- 若要播放 DLNA 服务器上的文件，本机和服务器必须连接到相同的存取点。
- 可能无法总是符合文件要求。视文件功能和 DLNA 服务器能力而定，可能有一些限制。







3 选择想要播放的文件。

注意

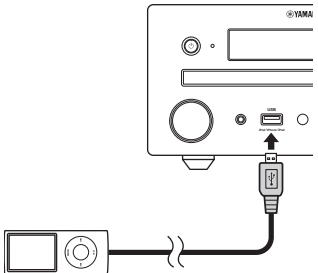
- 播放和操作质量可能会受到家庭网络条件的影响。
- 来自 USB 存储设备等可移动媒体或媒体服务器上的 DVD 驱动器的文件可能无法正确共享。

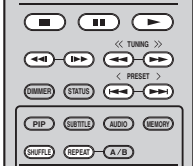
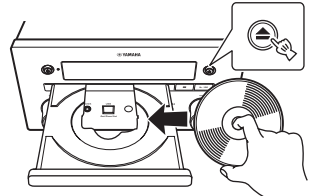
不使用 HOME/MEDIA 菜单的基本操作

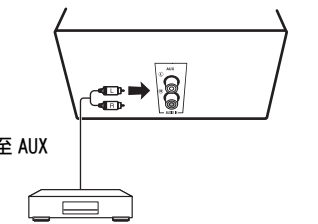
按照以下步骤播放源。

	1 放置源	2 切换输入	3 选择音乐并开始播放
iPod*1	 <p>第 11、20 页</p>		
CD	 <p>第 20 页</p>		
AUX	 <p>至 AUX</p>		有关操作的详细说明，请参阅 MD 播放器等所连接设备附送的使用说明书。
FM	若要接收 FM 无线电台，请参阅第 26 页。		
电视机	若要输出电视机声音，请参阅第 12 页进行连接并将输入源选择为电视机（第 7 页）。		

*1 视 iPod 的型号或软件版本而定，某些功能可能无法使用。

• 播放 iPod 时，会启用 Music Enhancer 功能，通过重新生成压缩时丢失的音乐元素增强压缩音乐的声音。（仅适用于 iPod。）

■ 控制音量

- 1 按遥控器上的音量控制按钮 (+/-) 调高 / 降低音量（第 7 页）。

■ 打开 / 关闭环绕播放模式

- 1 按 SURROUND 打开 / 关闭环绕播放模式（第 7 页）。
设定为开时：
 - 如果源为 BD 等环绕播放源，则使用 Yamaha 独有的 AIR SURROUND XTREME（第 48 页）播放环绕声。
 - 如果源为音频 CD 等立体声播放源，则再现更加宽广的立体声。

iPod 操作

通过使用遥控器上的按钮可以操作 iPod 的播放。

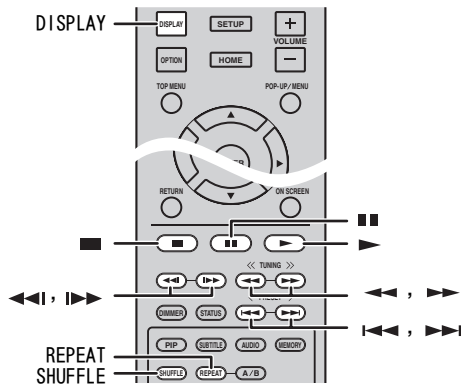

注意

视 iPod 的型号或软件版本而定，某些功能可能不兼容。

■ 播放控制

1 播放时按以下任意按钮。

- : 停止播放。
- ■ : 暂停播放。
- ▶▶: 向前跳跃。
- ◀◀: 向后跳跃。

若要开始 / 恢复播放，请按 ▶。



播放时按 DISPLAY 在前面板显示屏上显示以下信息。

- 歌曲名称
- 艺术家姓名
- 专辑名称

注意

有些字符无法在本机的前面板显示屏上显示。

■ 乱序播放

您可以以随机顺序播放。

1 反复按 SHUFFLE 进行乱序播放。

每按一次，如下循环：

SHUFFLE SONGS → (SHUFFLE ALBUMS)^{*1} → SHUFFLE OFF

*1 当您使用 iPod touch、iPhone 和 iPad 时，无法设定 ALBUMS。

■ 重复播放

可根据需要重复播放。

1 反复按 REPEAT 进行重复播放。

每按一次，如下循环：

REPEAT ONE → REPEAT ALL → REPEAT OFF

CD 操作

您也可以操作 CD 的音乐播放。

■ 播放控制

1 播放时按以下任意按钮。

- : 停止播放。
- ■ : 暂停播放。
- ▶▶: 向前跳跃。
- ◀◀: 向后跳跃。
- ▶▶: 向前搜索。
- ◀◀: 向后搜索。
- ▶▶▶: 按下可即时搜索。即时搜索跳过 30 秒音乐。
- ◀◀◀: 按下可即时重播。即时重播重播 10 秒前的音乐。

若要开始 / 恢复播放，请按 ▶。



您也可以使用数字按钮直接输入歌曲的编号。若要清除输入，请按 CLEAR。

■ 乱序播放

您可以以随机顺序播放。

1 反复按 SHUFFLE 进行乱序播放。

每按一次，如下切换：

SHUFFLE → NORMAL

■ 重复播放

可根据需要重复播放。

1 反复按 REPEAT 进行重复播放。

每按一次，如下循环：

REPEAT ONE → REPEAT ALL → REPEAT OFF

高级播放操作

本章节介绍市售 BD/DVD/CD 碟片和录制的 DVD-RW/R 碟片的播放。

注意

有关基本播放操作的说明，请参阅第 6 页。

屏幕菜单

若要显示屏幕菜单，请按 ON SCREEN。接着，按 ▲/▼/◀/▶ 选择项目，然后按 ENTER 操作所需功能。

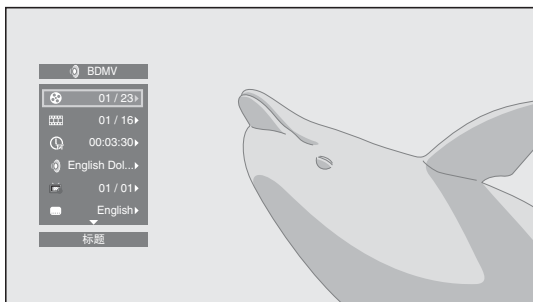

屏幕菜单包含以下项目。

标题 **BD** **DVD** **VIDEO**: 显示正在播放的标题编号。可从此项目选择所需标题而跳到该标题。

章节 **BD** **DVD** **VIDEO**: 显示正在播放的章节编号。可从此项目选择所需章节而跳到该章节。

曲目 / 文件 **CD** **VIDEO** **MUSIC** **PHOTO**: 显示正在播放的曲目 / 文件编号。可从此项目选择所需曲目 / 文件而跳到该曲目 / 文件。

时间 **BD** **DVD** **CD** **VIDEO** **MUSIC**: 显示播放时间。从以下选项选择显示类型：

- 标题、章节、碟片、曲目或文件的已播放时间。
- 标题、章节、碟片、曲目或文件的剩余播放时间。

模式 / 播放模式

DVD **CD** **VIDEO** **MUSIC** **PHOTO**: 显示当前播放模式。可从以下选项选择播放模式：

- **CD**
 - 一般：普通播放。
 - 乱序：随机播放而不重复。
 - 随机：随机重复播放。

DVD

- 一般
- 章节乱序 (章节)
- 标题乱序 (标题)
- 全部随机
- 章节随机 (章节)
- 标题随机 (标题)
- 全部随机

VIDEO MUSIC PHOTO

- 一般
- 乱序 F (文件夹)
- 随机 F (文件夹)

声音 **BD** **DVD** **VIDEO**: 显示当前所选 BD/DVD 碟片的音频语言 / 信号。可选择所需音频类型。

角度 **BD** **DVD**: 显示当前所选的角度编号。如果视频是以多角度录制，则可以更改角度。

角度

如果角度标记 () 设定为 [开] (第 35 页)，当此功能可用时，画面上显示 。

字幕 **BD** **DVD** **VIDEO**: 提供字幕时，显示当前所选的字幕语言。

字幕类型 **BD**: 显示当前所选的字幕类型。此功能仅适用于视频文件外部字幕。可选择所需字幕文本类型。

比特率 **BD** **DVD** **CD** **VIDEO** **MUSIC**: 显示音频 / 视频信号的比特率。

第二视频 **BD**: 打开 / 关闭 PIP (第 6 页)。

第二音频 **BD**: 打开 / 关闭第二音频。

Ins 搜索

BD **DVD** **CD** **VIDEO** **MUSIC**: 跳跃 30 秒。

Ins 重播

BD **DVD** **CD** **VIDEO** **MUSIC**: 重播 10 秒前的内容。

幻灯片 **PHOTO** :

显示幻灯片速度。可在慢 / 中 / 快中选择幻灯片速度。

转换 **PHOTO**: 显示图片显示在画面上的方式。可选择转换类型。

状态菜单

该菜单会显示各种设定，如字幕、角度设定和当前播放的标题 / 章节 / 曲目编号。若要显示状态菜单，请按 **STATUS**。状态菜单包含以下菜单。

BD DVD VIDEO

示例：播放 BD 碟片时的图标

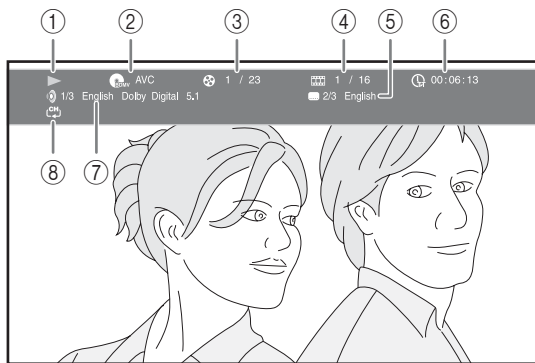

- ① (播放状态)
- ② (碟片类型 / 视频文件图标)
- ③ (正在播放的标题编号)：可用 **SEARCH** 按钮跳到指定标题 (第 7 页)。
- ④ (正在播放的章节编号)：可用 **SEARCH** 按钮跳到指定章节 (第 7 页)。
- ⑤ (当前所选的标题)：可用 **SUBTITLE** 按钮更改字幕语言 (第 6 页)。
- ⑥ (已播放时间)：可用 **SEARCH** 按钮跳到指定点 (第 7 页)。
- ⑦ (当前所选的音频)：可用 **AUDIO** 按钮更改音频语言或格式 (第 7 页)。
- ⑧ (重复模式)：显示当前的重复模式 (第 6 页)。

CD MUSIC

示例：播放音乐文件时的图标

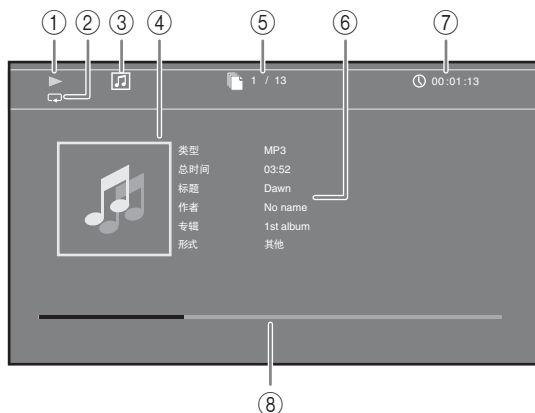

- ① (播放状态)
- ② (重复模式)：显示当前的重复模式 (第 6 页)。
- ③ (碟片类型 / 音乐文件图标)
- ④ (封面) **MUSIC**：如果文件中包含封面，则显示该封面。
- ⑤ (正在播放的曲目 / 文件编号)：可用 **SEARCH** 按钮跳到指定曲目 (第 7 页)。
- ⑥ (信息) **MUSIC**：如果文件中包含音乐信息，则显示该信息。
- ⑦ (已播放时间)：可用 **SEARCH** 按钮跳到指定点 (第 7 页)。
- ⑧ (进度条) **MUSIC**：显示当前歌曲的进度状态。

PHOTO

示例：观看图片文件时的图标



- ① (播放状态)
- ② (图片文件图标)
- ③ (正在显示的文件编号)
- ④ (重复模式)：显示当前的重复模式 (第 6 页)。
- ⑤ (幻灯片速度)

使用书签

可在视频的指定点设定书签。书签设定后，可移动到使用此功能设定的点。最多可设定 12 个书签。

DVD VIDEO

示例：播放电影时设定书签。

- 1 播放电影时按 **MARKER** 设定书签。将显示书签编号和状态。

书签: 1/12 标题: 1 章节: 1 时间: 00:01:26

- 2 书签设定后，按 **DIGEST** 显示书签选择条。

标题:01 章节:01 时间:00:01:26 书签
 01 02 03 04 05 06 07 08 09 10 11 12 清除

- 3 按 **◀/▶** 选择想要播放的书签，然后按 **ENTER**。按 **CLEAR** 删除所选的书签。

注意

播放结束时（例如：弹出碟片，按两次 **■**），书签被自动删除。

编程播放

可编程音频碟片曲目或 DVD 章节的播放顺序。最多可编程 15 个曲目 / 章节。

DVD CD

示例：编程 CD 曲目的播放顺序

- 1 播放时按 **PROGRAM** 显示节目画面。



- 2 按 **ENTER** 编程播放顺序。
 对于音频碟片，按 **▲/▼** 选择所需曲目，然后按 **ENTER**。
 对于 DVD 视频碟片，选择所需标题（显示为 TT）和章节（显示为 CH），而非曲目。
 若要清除设定的曲目，请选择想要清除的曲目，然后按 **CLEAR**。
 按 **RETURN** 取消编程播放。

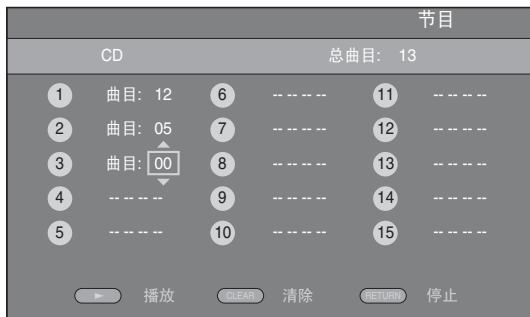

- 3 编程结束后，按 **▶** 设定和开始编程播放。

- 4 若要取消编程播放，请按 **■** 两次完全停止播放。

使用搜索

播放时可跳到指定点。

BD DVD CD VIDEO MUSIC



示例：搜索到指定点

- 1 播放时按 **SEARCH**。出现状态条。
- 2 按 **▲/▼/◀/▶** 选择以下项目之一，然后按 **ENTER**。



BD DVD :

 - 标题编号 (显示为 )
 - 章节编号 (显示为 )
 - 已播放标题时间 (显示为 )
 - 已播放章节时间 (显示为 )

CD :

 - 曲目编号 (显示为 )
 - 已播放曲目时间 (显示为 )
 - 已播放碟片时间 (显示为 )

VIDEO MUSIC :

 - 文件编号 (显示为 )
 - 已播放文件时间 (显示为 )
- 3 按 **▲/▼** 或数字按钮设定 / 调节突出项目的值，并按 **ENTER** 跳到指定点。
- 4 若要关闭状态条，请按 **STATUS**。

欣赏 BONUSVIEW™ 和 BD-Live™

本机支持 BONUSVIEW (第 48 页) (BD-ROM Profile 1 Version 1.1) 和 BD-Live (第 48 页) (BD-ROM Profile 2) 播放功能。

注意

功能和播放方法可能因碟片而异。请参阅碟片的指南或附送的使用说明书。

■ 使用画中画功能 (第二音频 / 视频播放)

可播放包含第二音频和视频且兼容画中画的 BD 视频，第二音频和视频在角落作为一个小视频同时播放。

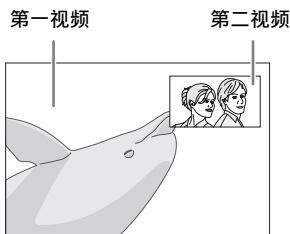

- 1 显示画中画标记 () 或第二音频标记 () 时，按 **PIP** 打开 / 关闭画中画功能。

注意

- 若要聆听来自用 HDMI 电缆连接的电视机的第二音频，请确保音频输出设定 (HDMI) 设定为 [PCM] (第 38 页)。
- 视碟片而定，若要聆听第二音频，可能需要从碟片的顶部菜单将第二音频设定为开 (第 8 页)。
- 视内容而定，可能会自动播放和删除画中画的第二音频和视频。此外，可播放区域可能会受限制。

■ 使用 BD-Live™ 的功能

1 设定网络设定（第 35 页）。

2 将 USB 存储设备连接到本机（第 13 页）。

- BD-Live 数据保存在本机所连接的 USB 存储设备中。
- 将支持 USB 2.0 高速（480 兆比特 / 秒）的 USB 存储设备（2 GB 或更大且以 FAT 32/16 格式化）连接到本地存储（第 34 页）上所选择的 USB 端口。默认设定为后面板上的 USB 端口。
- 必要时，“BUDA”文件夹在 USB 存储设备中自动创建。
- 如果存储空间不足，将不会复制 / 下载数据。删除不需要的数据或使用新的 USB 存储设备。
- 数据加载（读 / 写）可能需要一些时间。

3 播放碟片。

4 按照碟片上的说明运行 BD-Live。

注意

- 有关 BD-Live 内容的播放方法等，请按照 BD 碟片说明书中的说明执行操作。
- 若要享用 BD-Live 功能，请执行网络连接（第 13 页）和网络设定（第 35 页）。
- 关于限制访问 BD-Live 内容的设定，请参阅“[BD-Live 连接]”（第 35 页）。
- 将提供的程序下载到连接到本机的 USB 存储设备所需的时间因互联网连接速度和程序的数据量而异。
- 视提供商的状态（升级）而定，通过互联网提供的 BD-Live 程序可能无法显示连接。在此情况下，请取出碟片并重试。
- 如果在选择 BD 碟片菜单中的 BD-Live 功能后一段时间内不出现 BD-Live 画面，USB 存储设备可能可用空间不足。在此情况下，请从本机中弹出碟片，然后选择 [本地存储]（第 34 页）中的 [格式化] 删除 USB 存储设备中的数据。

聆听 FM 无线电台

调到无线电台

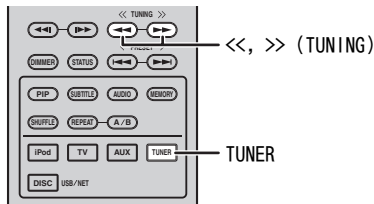

- 1 按 TUNER。
- 2 按住 <</>> (TUNING)。开始自动调谐。

如果从想要选择的电台接收到的信号微弱，您也可以反复按 <</>> (TUNING) 手动调入无线电台。在此情况下，声音将为单声道。

预设无线电台

您可以通过预设功能存储喜欢的 FM 电台。

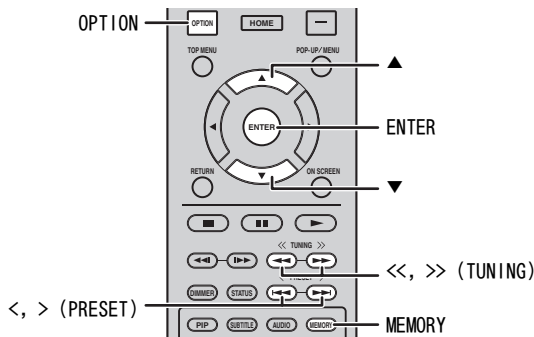

■ 自动预设调谐

- 1 在 FM 模式中按住 MEMORY 超过 3 秒。
- 2 按 ENTER。开始自动预设。

注意

当您执行自动预设时，所有存储的电台将被清除并存储新的电台。

■ 手动预设调谐

- 1 通过按 <</>> (TUNING) 选择某个喜欢的无线电台。
- 2 按 MEMORY。
- 3 通过按 ▲/▼ 或 </> (PRESET) 选择想要存储的预设编号。
- 4 按 ENTER。手动预设完成。



- 最多可以预设 30 个 FM 电台。
- 若要在选择预设编号时取消手动预设，请再次按 MEMORY。
- 您可以通过按 OPTION → ▲/▼ → ENTER 选择 [PRESET DEL] 来删除预设电台（第 27 页）。

选择预设无线电台 (预设调谐)

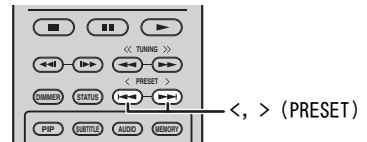

- 1 通过按 </> (PRESET) 在 FM 模式中选择预设无线电台。



也可以使用遥控器上的数字按钮或本机前面板上的 </> (PRESET) 选择预设无线电台。

使用实用功能

使用前面板显示屏上的选项菜单

按 **OPTION** 时前面板显示屏上会出现选项菜单。您可以通过选项菜单设定多种有用的功能。

选项菜单	参数或控制范围	参考页
PRESET DEL	(只有当输入源设定为 FM 时才会显示。)	26
TREBLE	-10 dB 至 +10 dB	下面
BASS	-10 dB 至 +10 dB	下面
BALANCE	L+5 - CENTER - R+5	下面
BASS BOOST	ON/OFF	下面

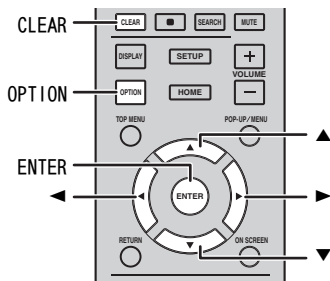

■ 设定音调 / 平衡

[TREBLE]*2: 调节高频响应。

[BASS]*2: 调节低频响应。

[BALANCE]: 调节每个左、右扬声器声道的音量。

[BASS BOOST]: 设定为 [ON] 时增强低频响应。

*2 使用耳机时同样有效。

- 1 按 **OPTION**。
- 2 通过按 **▲/▼** 选择所需选项菜单。
- 3 按 **ENTER** 确认。
- 4 通过按 **▲(▶)/▼(◀)** 更改设定。
- 5 按 **ENTER** 完成设定。*1
- 6 按 **OPTION** 退出选项菜单。

*1 若要设定其它项目，请重复步骤 2 至 5。

设定时钟 / 定时器和睡眠定时器

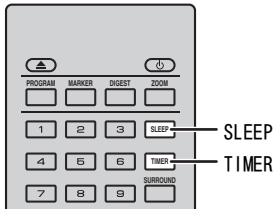

■ 设定时钟

可通过遥控器直接设定时钟。前面板显示屏上出现时钟。

- 1 按 TIMER。
- 2 按 ENTER。
- 3 通过按 ▲/▼ 设定小时和分钟。
按 ◀/▶ 切换小时或分钟设定。
- 4 按 ENTER 完成设定。



设定时钟时，您也可以使用**数字按钮**输入小时和分钟。若要确认输入，请按 ENTER。若要清除输入，请按 CLEAR。

注意

如果从墙壁插座拔出电源线，时间设定将会丢失。

■ 设定定时器

定时器可以将本机设定为在到达设定的时间时播放源。

- 1 按 TIMER。
- 2 通过按 ▲/▼ 选择所需设定项目（OnTime/Period/Source/Volume）。
- 3 按 ENTER 确认项目。

4 通过按 ▲/▼ 或数字按钮更改设定。

5 按 ENTER 确认设定。

6 重复步骤 2 至 5 设定各设定项目。



- 若要清除输入，请按 CLEAR。
- 将保留定时器的设定。

以下说明定时器设定的流程。

(时钟)



OnTime (小时和分钟)
设定所需时间以执行定时器。



Period (播放时间)
通过选择 [---]，播放时间无限。



设定 Source 或预设编号

注意

如果未正确设定源，您将不会听到定时器的声音。务必正确设定源。

CD:

当您选择 CD 作为源时，本机会继续播放上次聆听的音乐。

iPod:

当您选择 iPod 作为源时，本机会继续播放上次聆听的音乐。

FM:

设定预设编号。
通过选择 [---]，上次设定的 FM 电台将被设定。



Volume

可以在 [1] - [MAX] 和 [---]*1 之间设定音量电平。如果在本机处于待机模式中时执行定时器，将采用此时设定的音量电平。如果在本机开启时执行定时器，音量电平将与当前音量电平保持一致。

*1 如果您将音量设定为 [---] 且当本机在待机模式中时执行定时器，将采用与输入源相同的音量电平。

定时器设定完成。

通过按 ◀/▶ 将定时器切换为 [OFF]/[ONCE]/[EVERY]。定时器设定为 [ONCE] 或 [EVERY] 时，TIMER 指示灯将在前面板中点亮。

注意

- 必须预先设定时钟。
- 设定了定时器时，TIMER 指示灯将在前面板中点亮。电源开启时，随着定时器临近设定时间，TIMER 指示灯将会闪烁。

■ 设定睡眠定时器

睡眠定时器可在经过指定的时间后将本机设定为待机模式。

1 反复按 SLEEP。



通过电视机遥控器操作本机 (HDMI 控制功能)

如果电视机支持 HDMI 控制功能且连接到本机的 HDMI 端子，则可使用电视机遥控器操作本机。

电视机的遥控器 (示例)



也可使用以下功能。

- 开始在本机上播放 CD 碟片以外的 DVD/BD 碟片或显示 HOME/ 设置菜单画面时，电视机的输入选择器自动切换到本机 (一键播放)。

*1 通过电视机遥控器选择本机输出电视机声音时，本机自动选择电视机作为输入源，且可从连接到本机的扬声器或耳机欣赏声音。

注意

- 电视机必须为支持 ARC 的电视机。
- 对于某些电视机，通过电视机遥控器的光标按钮也许可以操作本机。
- 即使电视机支持 HDMI 控制功能，某些功能也可能无效。详情请参阅电视机附送的说明书。
- 视电视机而定，HDMI 控制功能可能无法正常工作。
- 上述以外的功能可能视电视机而定。
- 若要使 HDMI 控制功能生效，请设置所有组件 (本机、电视机和其他组件) 上 HDMI 控制功能的设定。可能还需要某些操作。
- 视电视机而定，各功能可能要单独设定为激活 / 禁用。
- 有关设定的详细说明，请参阅电视机附送的使用说明书。

■ 设定 HDMI 控制功能

- 1 打开所有以 HDMI 连接到电视机的组件。
- 2 检查所有以 HDMI 连接的组件并在各组件上启用 HDMI 控制功能。

对于本机，将 [HDMI 控制] 设定为 [开] (第 34 页)。

对于外接组件，请参阅各组件附送的说明书。



- 本机 [HDMI 控制] 的默认设定为 [关]。
- 电视机设定示例
 - 从电视机的设定菜单，选择“链接设定” → “HDMI 控制设定”(示例)，然后将“HDMI 控制功能”等设定设为“开”(示例)。
 - “扬声器优先级”等设定应设为“AV 放大器”。

- 3 关闭电视机，然后重新打开。

■ 将 HDMI 组件注册到电视机

- 1 选择本机作为电视机的输入源。
- 2 选择碟片 /USB/ 网络作为本机的输入源。
- 3 检查来自本机的图像是否正确显示在电视机上。
- 4 检查 HDMI 控制功能是否工作 (使用电视机遥控器打开本机或调节音量电平)。



对于某些 HDMI 组件，只需设定 HDMI 控制功能。在此情况下，无需将 HDMI 组件注册到电视机。

如果 HDMI 控制功能不工作

检查以下项目：

- 电视机是否连接到本机的 HDMI 端子。HDMI 控制功能在设置菜单中是否设定为 [开] (第 34 页)。
- HDMI 控制功能是否在电视机上启用。(同时检查电源互锁功能或扬声器优先级等相关设定。)

即使检查以上项目，HDMI 控制功能也不工作

- 关闭本机和电视机，然后再重新打开。
- 拔下本机、电视机和以 HDMI 连接到电视机的外接组件的交流电源线。约 30 秒后再次插入。

■ 更改连接方法和所连接的组件



所连接的组件和插孔更改时，按以下步骤重新设定本机。

- 1 关闭电视机和本机的 HDMI 控制功能，关闭所有连接的设备，并更改连接。
- 2 执行“设定 HDMI 控制功能”的步骤 1 至 3 (第 30 页)。

设置菜单

设置菜单启用各种音频 / 视频设定和调节使用遥控器的功能。

菜单 / 子菜单	项目	功能	页码	
 通用设置	系统	屏幕保护	将屏幕保护设定为开 / 关。	34
		自动关机	Disc/USB/Net: 将自动关机模式设定为开 / 关。 其他输入: 将自动关机模式设定为定时打开或关。	34
		碟片自动播放	将本机设定为自动开始碟片播放。	34
		HDMI 控制	将本机设定为从电视机的遥控器接收控制信号。	34
		加载预设值	将安全设定以外的所有设定复位到默认设定。	34
		升级	执行本机的升级。	34
		简易设置	设定语言、分辨率、画面纵横比。	34
		本地存储	显示本地存储的状态、格式化本地存储, 并选择本地存储的前 / 后 USB 端口。	34
		3D 播放信息	打开本机时, 会显示关于 3D 视频播放的警告信息。	34
	语言	屏幕显示	选择屏幕显示的语言。	34
		菜单	区分碟片菜单语言的优先顺序。	34
		声音	区分音频语言的优先顺序。	34
		字幕	区分字幕语言的优先顺序。	34
	播放	隐藏字幕	将隐藏字幕设定为开 / 关。	35
		角度标记	设定为播放具有多角度的 BD/DVD 碟片时显示角度标记。	35
		画中画标记	设定为播放具有画中画的 BD/DVD 碟片时显示画中画标记。	35
		第二音频标记	设定为播放具有第二音频的 BD/DVD 碟片时显示第二音频标记。	35
		记忆播放	将本机设定为当设为待机模式或打开碟片托盘时, 记忆碟片的上次播放位置。	35
	安全	更改密码	更改父母锁和国家区域的密码。	35
		父母锁	根据碟片内容设定父母锁。	35
		国家区域	设定国家区域。	35
	网络	互联网	将互联网连接设定为启用 / 停用。	35
		信息	显示网络信息画面。	35
		连接测试	执行网络连接测试。	35
		IP 设置	将 IP 设置设定为自动 / 手动。	35
		BD-Live 连接	将 BD-Live 连接设定为允许 / 部分允许 / 禁止。	35
		DLNA	将 DLNA 连接设定为启用 / 停用。	35
		代理服务器设置	设定代理服务器设定。	35

菜单 / 子菜单	项目	功能	页码	
 显示设定	TV	3D 输出	选择 3D 或 2D 视频。	36
		电视屏幕	设定所连接电视机的画面纵横比，并调节视频输出。	36
		视频输出选择	选择视频输出的分辨率。	36
		电视系统	从 NTSC/PAL/ 多制式中选择电视系统。	36
		彩色空间	从 YCbCr 4:4:4/YCbCr 4:2:2/ 全 RGB/RGB 中选择彩色空间。	36
		HDMI 深色	从 30 比特 /36 比特 / 关中选择 HDMI 深色。	36
		HDMI 1080p 24Hz	将 HDMI 1080p 24Hz 设定为自动 / 关。	37
		唇形同步	调整视频和音频之间的延迟，如当嘴部动作与声音不同步时。	37
	视频处理	影片模式	调整视觉图像。	37
		色彩调整	调整每种颜色的亮度 / 饱和度 / 色调。	37
		杂讯降低	设定杂讯降低的级别。	37
去交错模式		设定如何检测视频信号。	37	
 音频设定	音频输出	HDMI	从比特流 /PCM/ 关中选择 HDMI 端子的输出模式。	38
		动态范围控制	设定动态范围控制（动态范围压缩）。	38
	后级处理	UpMix	为 2 声道音频信号建立多声道。	38
 系统信息		显示软件版本和 MAC 地址（第 49 页）。	38	

设置菜单操作

您需要显示设置菜单画面来执行本机的设定。以下说明设置菜单的基本操作。

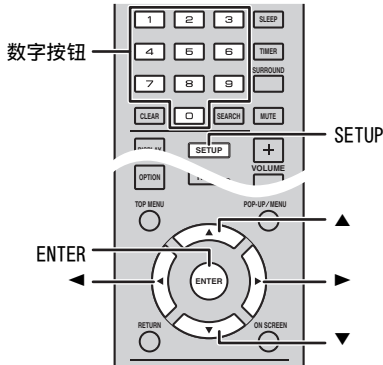

示例：设定 [父母锁]

注意

- 当设定为碟片 /USB/ 网络以外的输入源时, 无法设定某些项目。在此情况下, 请将输入源设定为碟片 /USB/ 网络。
- 播放时无法设定某些项目。在此情况下, 请在设定前按两次 **■** 完全停止播放。

- 1 按 **SETUP** 显示设置菜单画面。
按 **◀/▶** 选择 [通用设置], 然后按 **ENTER** 或 **▼**。



- 2 选择子菜单。
按 **▲/▼** 选择 [安全], 然后按 **ENTER** 或光标 **▶**。

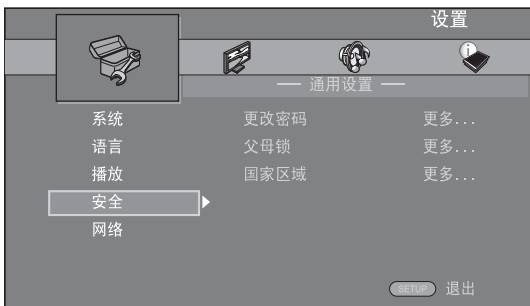

- 3 选择菜单项目。
按 **▲/▼** 选择 [父母锁], 然后按 **ENTER** 或光标 **▶**。



- 4 用数字按钮输入密码。
 - 默认密码为 0000。
 - 输入正确的密码后, 您才能移动到下一个设定画面。
 - 若要更改密码, 请参阅 “[更改密码]” (第 35 页)。



- 5 选择下一个项目。
按 **▲/▼** 选择 BD/DVD 碟片的父母锁等级, 然后按 **ENTER**。



- 6 退出菜单画面。
按 **◀** 返回上一个菜单。

通用设置

默认设定标有“*”。

■ 系统

[屏幕保护]

可将屏幕保护设定为 [开]/[关]。
设定为 [开] 时, 如果 3 分钟无操作, 本机将切换到屏幕保护模式。

开*, 关

[自动关机]

当输入选择为碟片 /USB/ 网络时, 可以将自动关机模式设定为 [开]/[关]。当选择其他输入时, 自动关机模式可按小时设定或设定为 [关]。

Disc/USB/Net: 开*, 关
其他输入: 1 小时, 2 小时, 4 小时, 8 小时*, 关

[碟片自动播放]

可将 [碟片自动播放] 设定为 [开]/[关]。设定为 [开] 时, 碟片装入后将自动播放。

开*, 关

[HDMI 控制]

可将本机设定为通过 HDMI 电缆从与 HDMI 控制功能兼容的电视机接收控制信号 (第 12 页)。

开, 关*



有关 HDMI 控制功能的详细说明, 请参阅第 29 页。

注意

设定为 [开] 时, 待机模式期间的功耗会因 HDMI 控制功能而增加。

[加载预设值]

可将本机除安全设定以外的所有设定复位到默认设定 (第 35 页)。有关默认设定的详细说明, 请参阅第 31-38 页。

[升级]

可从 [USB 存储器] 或 [网络] 手动升级软件。有关软件升级的详细说明, 请参阅“软件升级” (第 40 页)。

[简易设置]

可执行简易设置 (第 14 页)。

[本地存储]

可以显示本地存储信息、格式化本地存储, 并选择 [前置 USB]/[后置 USB] 以保存 BD-Live 数据。若要格式化 (清空) USB 存储设备中的“BUDA”文件夹, 请选择 [信息], 并在画面上突出显示 [格式化] 时按 ENTER。

前置 USB, 后置 USB*



本地存储在播放 BD 碟片时用作辅助存储器。

[3D 播放信息]

可以打开或关闭打开本机时电视机上出现的有关 3D 视频播放的警告信息。

开*, 关

■ 语言

[屏幕显示]

可选择信息或设置菜单等屏幕上所显示菜单的屏幕显示语言。

English, Français, Español, Deutsch, Italiano, Svenska, Nederlandse, Русский, 中文

[菜单]

可区分碟片菜单语言的优先顺序。

English, Français, 中文, Español, Deutsch, Italiano, Nederlandse, 葡萄牙文, 丹麦文, Svenska, 芬兰文, 挪威文, Русский, 韩文, 日文, 更多

[声音]

可区分 BD/DVD 播放的音频语言的优先顺序。有关设定项目的详细说明, 请参阅“[菜单]” (第 34 页)。

[字幕]

可区分字幕语言的优先顺序。

English, Français, 中文, Español, Deutsch, Italiano, Nederlandse, 葡萄牙文, 丹麦文, Svenska, 芬兰文, 挪威文, Русский, 韩文, 日文, 更多, 关

[语言] 中的默认设定因机型而异。

■ 播放

[隐藏字幕]

可设定为当播放带有隐藏字幕的 BD/DVD 碟片时显示隐藏字幕（第 48 页）。

开, 关*

[角度标记]

设定为播放具有多角度的 BD/DVD 碟片时显示角度标记 ()。

开*, 关

[画中画标记]

设定为播放具有画中画（第 24 页）的 BD 碟片时显示画中画标记 ()。

开*, 关

[第二音频标记]

设定为播放具有第二音频的 BD 碟片时显示第二音频标记 ()。

开*, 关

[记忆播放]

可以将本机设定为当设为待机模式或打开碟片托盘时, 是否记忆碟片的上次播放位置。

开*, 关

注意

某些碟片与此功能不兼容。

■ 安全

[更改密码]

可设定更改父母锁等级和国家区域的密码。请参阅“[父母锁]”（第 35 页）和“[国家区域]”（第 35 页）。

注意

- 默认密码为 0000。
- 如果忘记了密码, 请参阅“故障排除”（第 41 页）并将所有安全设置设定为默认设定。

[父母锁]

在某些 BD/DVD 碟片中, 观看碟片的控制等级根据观众的年龄而设定。您可根据碟片内容设定画面上显示的父母锁。

设定父母锁等级之前, 需要输入密码（请参阅第 35 页上的“[更改密码]”）。

设定父母锁后, 当您播放等级高于当前父母锁等级的碟片时, 或您想要更改父母锁等级时, 将弹出一个对话框, 要求您输入密码。

关*, 1 至 8

[国家区域]

可设定居住地的国家区域。设定国家区域之前, 需要输入密码（请参阅第 35 页上的“[更改密码]”）。此设定可以用于父母锁的评级和碟片播放。

■ 网络

[互联网]

通过网络使用 BD-Live（第 24 页）、DLNA（第 18 页）和软件升级时, 可以设定为 [启用]（第 40 页）。

启用*, 停用

[信息]

可显示网络信息画面。在此画面上, 可查看界面（以太网）、地址类型、IP 地址、子网掩码、默认网关和 DNS 的信息。

[连接测试]

可以执行互联网连接测试。如果测试失败, 请检查 [IP 设置]（第 35 页）并重新执行测试。

[IP 设置]

可以配置网络设置。

自动* 选择以使用 DHCP 服务器自动配置本机的网络设置。

手动 选择以手动配置网络设置（IP 地址、子网掩码、默认网关和 DNS）。



- 数字按钮 输入字符。
- ◀▶ 移动突出显示。
- CLEAR 删除字符。
- ENTER 保存设定并退出菜单。

[BD-Live 连接]

可将存取限制设定到 BD-Live 内容。

允许 允许所有 BD-Live 碟片连接网络。

部分允许* 仅允许经所有者认证的碟片。

禁止 禁止所有 BD-Live 碟片连接网络。

[DLNA]

可将 DLNA（第 18 页）设定为 [启用]/[停用]。不使用 DLNA 功能时, 设定为 [停用]。

启用*, 停用

[代理服务器设置]

可设定代理服务器设置。正常使用时设定为 [停用]。设定为 [启用] 以设定代理服务器设置。

启用 启用代理服务器主机和代理服务器端口设置。

停用* 将代理服务器设定为停用。不使用代理服务器时选择此项目。

代理服务器主机 设定代理服务器主机。

代理服务器端口 设定代理服务器端口。

显示设定

默认设定标有“*”。

■ TV

[3D 输出]

可以选择来自本机的 3D 或 2D 视频输出。

- 自动* 本机自动选择 3D 或 2D 视频。
- 关 本机总是选择 2D 视频。

注意

即使将 [3D 输出] 设定为 [自动] 并播放 BD 3D 碟片，本机也会根据电视机等的连接和设定选择 2D 图像（第 12 页）。



[电视屏幕]

可设定所连接电视机的画面纵横比，并调节视频输出。

如果您更换电视机（即，因为买了台新电视机）且所连接电视机的画面纵横比改变，您必须更改电视屏幕设定。

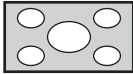
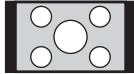
- 16:9 全屏幕** 当本机连接到具有 16:9 画面的电视机时，选择此项。播放 4:3 纵横比视频时，视频如下显示。
- 16:9 正常*** 当本机连接到具有 16:9 画面的电视机时，选择此项。播放 4:3 纵横比视频时，视频如下显示。
- 4:3 全景** 当本机连接到具有 4:3 画面的电视机时，选择此项。播放 16:9 纵横比视频时，视频如下显示。
- 4:3 信箱** 当本机连接到具有 4:3 画面的电视机时，选择此项。播放 16:9 纵横比视频时，视频如下显示。

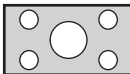
原始图像尺寸	在 16:9（宽屏）电视机上	
	16:9 全屏幕	16:9 正常
 4:3		

原始图像尺寸	在 4:3 电视机上	
	4:3 全景	4:3 信箱
 16:9		

[视频输出选择]

可从 [模拟视频]、[HDMI 自动]、[HDMI 1080p]、[HDMI 1080i]、[HDMI 720p]、[HDMI 480p/576p] 和 [HDMI 480i/576i] 中选择视频输出分辨率。设定为 [HDMI 自动] 时，分辨率将根据所连接的电视机设定为最大分辨率。有关输出格式的详细说明，请参阅“关于视频输出格式”（第 39 页）。

模拟视频，HDMI 自动*，HDMI 1080p，HDMI 1080i，HDMI 720p，HDMI 480p/576p，HDMI 480i/576i

注意

- 当通过 VIDEO 插孔连接电视机和本机时，请选择 [模拟视频]、[HDMI 480p/576p] 或 [HDMI 480i/576i]。
- 若要从 HDMI 端子输出 HD 音频（如 Dolby TrueHD 或 DTS-HD），请将 [视频输出选择] 设定为 [HDMI 自动] 或大于 [HDMI 720p]。

[电视系统]

可以从 [PAL]、[NTSC] 和 [多制式] 中选择 [电视系统]。设定与您电视机相同的电视系统。有关输出格式的详细说明，请参阅“关于视频输出格式”（第 39 页）。

NTSC，PAL*，多制式（澳大利亚、亚洲、中国、英国、欧洲和俄罗斯型号）

NTSC*，PAL，多制式（中美洲和南美洲型号）

[彩色空间]

可选择从 HDMI 输出的彩色空间（第 48 页）。用 HDMI 电缆连接本机时此功能可用。

YCbCr 4:4:4* 将彩色空间设定为 YCbCr 4:4:4。

YCbCr 4:2:2 将彩色空间设定为 YCbCr 4:2:2。

全 RGB 当设置了 RGB 并且白色和黑色在画面上太暗时，请选择此项目。当连接的组件支持 RGB 0-255 范围时此设定有效。

RGB 以正常信号范围输出视频信号。

注意

此功能仅适用于支持此功能的电视机。

[HDMI 深色]

当您的电视机与 Deep Color（深色）（第 48 页）兼容时，请根据您的电视机设定此项目。用 HDMI 电缆连接本机时此功能可用。

30 比特，36 比特，关*

[HDMI 1080p 24Hz]

此项输出以 HDMI 1080p 24Hz 中 24Hz 帧频编码的 BD 视频。使用此功能可能会使视频播放更加流畅。当您的电视机支持此功能，且本机用 HDMI 电缆连接时，此功能可用。有关输出格式的详细说明，请参阅“关于视频输出格式”（第 39 页）。

自动 *，关

注意

当输出分辨率非 1080p 时，此设定被停用。

[唇形同步]

可以设定 / 调整唇形同步（第 49 页）功能。

自动 *	本机自动调节唇形同步功能。
手动	可以手动调整唇形同步功能。可以分别设定 2D 和 3D 内容的音频延迟。
	2D
	3D
关	本机不调节唇形同步功能。

■ 视频处理**[影片模式]**

可选择下面的 [影片模式]。

标准 *	图像最自然平衡。此模式适合正常使用。
鲜艳	图像更为鲜艳清晰。
电影	图像适合在黑暗的房间内观看电影。
自定	可以手动调整视觉图像。按 ▲/▼ 选择参数，然后按 ◀/▶ 调整数字。
	亮度 调整图像的整体亮度。
	饱和度 调整投影图像中的色彩鲜艳度。
	色调 调整投影图像的色调。
	对比 调整图像中的明亮区域（白色电平）。
	清晰度 调整视频中对象的清晰度。
	CTI 平滑彩色图像的边缘。彩色图像呈现地更加清晰。
	默认设定为 0。

[色彩调整]

可以调整每种颜色（红色 / 绿色 / 蓝色 / 黄色 / 青色 / 红紫色）的亮度 / 饱和度 / 色调。若要使用此功能，请将 [影片模式] 设定为 [自定]。有关设定项目的详细说明，请参阅“[影片模式]”（第 37 页）。

默认设定为 0。

[杂讯降低]

可以将杂讯降低设定为等级 0 到 3。0 为关闭，3 为最大等级。

0*，1，2，3

[去交错模式]

可以选择如何检测视频信号。正常使用时设定为 [自动]。当画面上出现水平带状噪点时，将该值设定为 [电影] / [视频] 以去除噪点。

自动 *，电影，视频

音频设定

默认设定标有“*”。

■ 音频输出

[HDMI]

可选择 HDMI 端子的输出模式。

比特流, PCM, 关*

注意

- 若要从扬声器或耳机输出声音, 请选择 [关]。
- 无法通过 HDMI 电缆将 iPod 的声音从本机输出到电视机。
- 若要从 HDMI 端子输出 HD 音频 (如 Dolby TrueHD 或 DTS-HD), 请将 [视频输出选择] 设定为 [HDMI 自动] 或大于 [HDMI 720p] (第 36 页)。

[动态范围控制]

可将动态范围控制 (动态范围压缩) (第 49 页) 设定为 [开]/[关]/[自动]。设定为 [自动] 时, 对于带动态范围控制信息的 Dolby TrueHD 格式来源, 动态范围控制将自动打开。动态范围控制可使爆破声等响声降低, 而使谈话声更加清楚。在夜晚观看电影时此功能很有用。

关*, 开, 自动

■ 后级处理

[UpMix]

可以为 2 声道音频信号建立多声道 (对 HDMI 输出有效)。若要建立多声道, 请选择 [DTS NEO:6], 然后选择 [电影] 或 [音乐]。

关*, DTS NEO:6

■ 系统信息

显示软件版本和 MAC 地址 (第 49 页)。

关于视频输出格式

[电视系统] 设定为 [NTSC] 时

	分辨率	模拟视频	HDMI 自动	HDMI 480i/576i	HDMI 480p/576p	HDMI 720p	HDMI 1080i	HDMI 1080p	
								24Hz	其他
HDMI	播放 BD	480p	最大	480i	480p	720p 60 Hz	1080i 60 Hz	1080p 24 Hz	1080p 60 Hz
	其他							1080p 60 Hz	
VIDEO	播放 BD	480i	关	480i	480i	关			
	其他								

[电视系统] 设定为 [PAL] 时

	分辨率	模拟视频	HDMI 自动	HDMI 480i/576i	HDMI 480p/576p	HDMI 720p	HDMI 1080i	HDMI 1080p	
								24Hz	其他
HDMI	播放 BD	576p	最大	576i	576p	720p 50 Hz	1080i 50 Hz	1080p 24 Hz	1080p 50 Hz
	其他							1080p 50 Hz	
VIDEO	播放 BD	576i	关	576i	576i	关			
	其他								

[电视系统] 设定为 [多制式] 时

[电视系统] 设定为 [多制式] 时，视频信号以与源相同的频率输出。有关电视机的频率设定和输出视频信号的分辨率的详细说明，请参阅上表。

显示设置菜单等菜单画面时，视频信号以与源相同的频率输出。

注意

- 表中的“最大”是指分辨率被设定为所连接电视机支持的最大分辨率。
- 当输出分辨率非 [HDMI 1080p] 时，[HDMI 1080p 24Hz] 设定被停用。
- 当输出分辨率设定为 [HDMI 自动]、[HDMI 720p]、[HDMI 1080i] 或 [HDMI 1080p] 时，没有信号从 VIDEO 插孔输出。
- 当 [电视系统] 设定为 [NTSC] 且视频源非 60 Hz 时，视频输出信号转换为 60 Hz。
- 当 [电视系统] 设定为 [PAL] 且视频源非 50 Hz 时，视频输出信号转换为 50 Hz。

软件升级

如果不将本机软件升级到最新版本，可能无法播放某些新发售的 BD 碟片。建议用软件升级功能升级本机的软件，以便能基于最新软件操作本机。

若要检查软件升级的可用性，请访问

<http://download.yamaha.com/>

注意

正在执行软件升级时，请勿移除 USB 存储设备、将本机设定为待机模式或拔下电源线 / LAN 电缆插头。

升级软件

1 准备软件升级。

从 [网络] 升级软件时：

确认本机已连接到网络。

从 [USB 存储器] 升级软件时：

- ① 将升级文件包保存到 USB 存储设备上的合适文件夹。有关更多详细说明，请参阅升级文件包所附的程序文件。
- ② 连接 USB 存储设备。
如果当连接 USB 存储器时软件升级自动开始，请跳过以下步骤 2。

2 选择升级方法并从设置菜单开始升级。

- ① 按 **SETUP** 显示设置菜单画面。
- ② 选择 [通用设置] → [系统] → [升级]。
- ③ 从 [USB 存储器] / [网络] 中选择包含升级文件包的项目。

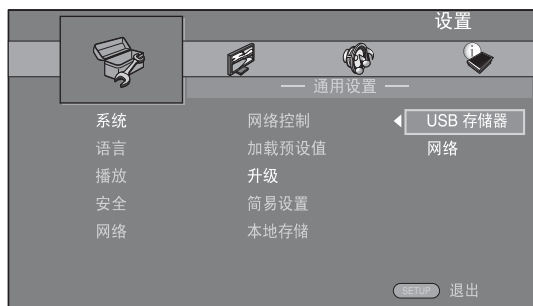

3 按照屏幕信息开始升级。

故障排除

当本机运作不正常时，请参阅以下表格。如果您所遇到的问题未在以下表格中列出或如果以下说明没有帮助，请关闭本机，断开电源线的连接，然后联系附近授权的 Yamaha 经销商或服务中心。

常规

问题	原因	解决方法	页码
不通电。		按前面板上的  打开电源。	5
本机电源无法打开或电源打开后立即进入待机模式。	电源线没有连接或插头没有完全插入。	请牢固连接电源线。	11
	本机可能已经受到强烈的外部电击（例如闪电或很强静电）。	将本机设定为待机模式，断开电源线的连接，30 秒后再连接电源线，然后正常使用本机。	—
本机工作不正常。	本机需要重启。	按住前面板上的  约 5 秒钟以重启本机。若要完全重启，请从交流插座上拔下电源线 5 至 10 秒钟，再重新将电源线插到交流插座上，然后打开本机。	5
	无法播放碟片。	未设定初始向导。	购买或升级后首次打开本机时设定初始向导。
没有声音。	选择了不合适的输入源。	用前面板上的 INPUT（或遥控器上的输入选择按钮）选择合适的输入源。	5
	扬声器连接不牢固。	确保牢固连接。	10
	静音功能开启。	取消静音功能。	7
	音量调低了。	调高音量。	7
	正在从源组件（例如 CD-ROM）输入本机无法再现的信号。	播放本机可以再现的源信号。	3
	[HDMI 控制] 设定为 [关]。	仅使用 HDMI 电缆连接支持 ARC（音频回传通道）的电视机和本机时，请将 [HDMI 控制] 设定为 [开]。	34
扬声器或耳机没有声音。	设置菜单中音频输出的 [HDMI] 未设定为 [关]。	将 [HDMI] 设定为 [关]。	38
无图像。	电缆连接不正确。	确保电缆正确连接。	12
		确保所连接的电视机设定为正确的输入。	12
	使用附送的视频插脚电缆将本机连接到具有 VIDEO 插孔的电视机。	12	
	— 如果本机连接到 VIDEO 插孔时仍不显示图像，请在未插入碟片并且播放停止时同时按住前面板上的  和  约 5 秒钟以切换 NTSC/PAL。	—	
电视机系统设定不正确。	在未插入碟片并且播放停止时同时按住前面板上的  和  约 5 秒钟以切换 NTSC/PAL。通过 HDMI 连接时重新正确设定分辨率（第 36 页）。	—	

问题	原因	解决方法	页码
电源突然关闭。	设定了睡眠定时器。	这不是故障。打开本机并重新播放源。	29
	[自动关机]设定为[开]。	将[自动关机]设定为[关]。	34
时钟设定被清除。	断开了电源线连接。	连接电源线，并重新设定时钟。	—
仅从一侧的扬声器听到声音。	电缆连接不正确。	正确连接电缆。如果问题仍然无法解决，电缆可能已损坏。	10
数字或无线电频率设备产生噪音干扰。	本机太靠近数字或高频设备。	将本机远离此种设备放置。	—
本机开始播放或载入碟片时发出劈响声。		这些声音并非本机故障，而是正常操作状态。	—
超低音扬声器没有声音。	超低音扬声器未正确连接。	检查超低音扬声器是否正确连接。	10
系统设定自动改变。	当[HDMI控制]设定为[开]时，电视机的操作（例如，更改频道等）会改变系统设定。	将[HDMI控制]设定为[关]或通过使用系统的遥控器重新设定系统。	34
HDMI控制功能无法正常工作。	[HDMI控制]设定为[关]。	将[HDMI控制]设定为[开]。	34
	HDMI控制功能在电视机上停用。	请参阅电视机附送的说明书并检查设定。	—
即使[唇形同步]设定为[自动]，自动唇形同步也无效。	电视机不支持自动唇形同步。	将[唇形同步]设定为[手动]，然后手动调节音频输出延迟。	37

无线电接收

问题	原因	解决方法	页码
FM立体声接收嘈杂。	天线未正确连接。	检查天线连接。	10
	当发射器太远或天线输入不良时，FM立体声广播的性质引起此问题。	尝试使用高质量定向FM天线。	—
		切换到单声道模式。	26
使用自动调谐方法无法调入想要的电台。	信号太弱。	使用高质量定向FM天线。	—
		使用手动调谐方法。	26
预设选择功能不起作用。	预设（记忆）已经删除。	重新预设无线电台。	26
即使使用良好的FM天线或室外天线，仍然有失真，无法获得清晰接收。	出现了多路反射或其它无线干扰。	改变天线的高度、方向或处所。	—

iPod

注意

在发生发送错误，但本机的前面板显示屏中未出现状态信息的情况下，请检查与 iPod 的连接（请参阅第 11 页）。

状态信息	原因	解决方法	页码
READING	本机正处在识别与 iPod 的连接过程中。	如果此信息持续出现在前面板显示屏中并且不开始播放，请重新连接 iPod。	—
UNKNOWN	从 iPod 到本机的信号路径有问题。	重新连接 iPod。	11
	本机不支持正在使用的 iPod。	仅支持 iPod classic、iPod nano（第 2 代、第 3 代、第 4 代、第 5 代和第 6 代）、iPod touch（第 1 代、第 2 代、第 3 代和第 4 代）、iPhone、iPhone 3G/3GS、iPhone 4 和 iPad。	11
	iPod 软件版本较老。	将 iPod 的软件版本升级到最新。	—
STOP	iPod 播放结束。 例如，所选专辑中的所有歌曲已经结束播放。		
NO iPod	iPod 与本机断开连接。	通过 USB 电缆正确连接 iPod 和本机。	11

问题	原因	解决方法	页码
没有声音。	本机电源处于关闭状态。	正确连接电源线。	11
	iPod 的软件版本尚未升级。	下载最新的 iTunes 软件并将 iPod 软件版本升级到最新。	—
	iPod 正在连接本机。	请稍候。	—
没有声音。	iPod 未正确连接。	通过 USB 电缆正确连接 iPod 和本机。	11
iPod 有声音，但是无法用本机或遥控器操作。			
电视机中没有 iPod 的声音。	无法通过 HDMI 电缆将 iPod 的声音从本机输出到电视机。	使用本机的扬声器。	—
本机无法通过遥控器操作。	本机不支持此 iPod。	仅支持 iPod classic、iPod nano（第 2 代、第 3 代、第 4 代、第 5 代和第 6 代）、iPod touch（第 1 代、第 2 代、第 3 代和第 4 代）、iPhone、iPhone 3G/3GS、iPhone 4 和 iPad。	11
	iPod 未正确连接。	通过 USB 电缆正确连接 iPod 和本机。	11
	iPod 的软件版本较老。	将 iPod 的软件版本升级到最新。如果即使采用了最新软件也无法解决问题，请重设 iPod。	—
无法从 iPod 操作。	iPod 未正确连接。	通过 USB 电缆正确连接 iPod 和本机。	11
前面板显示屏上不显示播放信息。	安装的 iPod 不支持播放信息显示。	仅支持 iPod classic、iPod nano（第 2 代、第 3 代、第 4 代、第 5 代和第 6 代）、iPod touch（第 1 代、第 2 代、第 3 代和第 4 代）、iPhone、iPhone 3G/3GS、iPhone 4 和 iPad。	11

问题	原因	解决方法	页码
iPod 不充电。	iPod 未正确连接。	通过 USB 电缆正确连接 iPod 和本机。	11
	本机不支持此 iPod。	仅支持 iPod classic、iPod nano（第 2 代、第 3 代、第 4 代、第 5 代和第 6 代）、iPod touch（第 1 代、第 2 代、第 3 代和第 4 代）、iPhone、iPhone 3G/3GS、iPhone 4 和 iPad。	11

USB

注意

在发生发送错误，但本机的前面板中未出现状态信息的情况下，请检查与 USB 设备的连接（请参阅第 13 页）。

状态信息	原因	解决方法	页码
USB ERROR	连接的 USB 设备在本机上不可播放。 USB 设备歪曲连接。	断开 USB 设备的连接。改变 USB 以外的输入源并重新选择 USB 作为输入源。然后重新连接可播放的 USB 设备。	13

问题	原因	解决方法	页码
USB 设备中的文件不播放。	USB 设备未被识别。	重新连接 USB 设备。 如果设备附带交流电源适配器，则连接交流电源适配器。	13 —
	USB 设备连接不正确。	重新连接 USB 设备。	13
	文件格式与本机不兼容。	请用本机可播放的正确录制的文件进行替换。	3
	如果以上办法无法解决问题，此 USB 设备无法在本机上播放。	尝试使用另一个 USB 设备。	—

碟片播放

■ 常规

问题	原因	解决方法	页码
没有声音或声音失真。	音频或视频文件的采样频率与本机不兼容。	检查音频或视频文件的采样频率和比特率是否与本机兼容。	3
		视音频录制状态而定，如当非音频信号或非标准音频录制为音频内容时，可能无法输出音频。	3
		静止模式、慢动作播放、快进和快退时无声音。	—

问题	原因	解决方法	页码
碟片播放没有开始。	碟片没有最终化。	CD-R/RW、DVD+R/RW/R DL 和 DVD-R/RW/R DL 必须被最终化。	3
	装入的碟片上下颠倒。	取出碟片并重新装入，确保标签面朝上。	—
	碟片有缺陷。	尝试播放另一张碟片。如果问题解决，表示您要播放的碟片有缺陷。	—
	文件格式与本机不兼容。	检查文件格式是否与本机兼容。	3
有些按钮操作不起作用。	本机装入的碟片不兼容。	使用本机支持的碟片。	3
按本机上的 ►/ 或遥控器上的 ► 后，播放未立即开始。	碟片脏污。	取出碟片并擦拭干净。	4
	本机装入的碟片不兼容。	使用本机支持的碟片。	3
	如果将本机从寒冷处带到温暖处，碟片读取激光头上就形成了结露。	等待一或两个小时，直到本机调整到室温后再重试。	—
即使碟片托盘中有碟片，显示屏中也出现 [No Disc]。	本机装入的碟片不兼容。	使用本机支持的碟片。	3
	碟片脏污。	取出碟片并擦拭干净。	4
	装入的碟片上下颠倒。	取出碟片并重新装入，确保标签面朝上。	—
不输出音频，或不正确播放图像。	此碟片受版权保护。	对于某些录制有版权保护内容的碟片，可能无法输出音频或无法正确播放图像。	—

■ 图像

问题	原因	解决方法	页码
画面定格且操作按钮不起作用。		按 ■，然后重新开始播放。	—
	本机需要重启。	关闭电源并重新打开电源。	—
		按住前面板上的 ⏻ 约 5 秒钟以重启本机。	—
视频未以所需分辨率输出。	分辨率设定不正确。	设定为所需分辨率。	36
宽屏视频显示时被垂直拉伸，或画面顶部和底部出现黑带。或者 4:3 视频显示时被水平拉伸。	电视机的纵横比设定不正确。	更改电视机的纵横比。	36
画面上出现方块形噪点 (马赛克)。		由于数字图像压缩技术的特性，快速移动的场景中可能会看到图像中的块状杂讯。	—
如果 DVD 视频录制到录像机，或通过录像机播放，播放画面会受到干扰。	此碟片受版权保护。	本机遵从模拟复制保护。某些碟片包含复制禁止信号。如果试图通过录像机播放此类碟片，或录制到录像机并播放该信号，复制保护将禁止正常播放。	—

遥控器

问题	原因	解决方法	页码
遥控器不工作或功能不正常。	遥控器在其操作范围之外操作。	有关遥控器操作范围的信息，请参阅“使用遥控器”。	9
	本机的遥控感应器暴露于直射阳光或灯光下。	改变照明或本机的方向。	—
	电池电量耗尽。	更换新电池。	9
	本机的感应器和遥控器之间有障碍物。	移除障碍物。	—

网络

问题	原因	解决方法	页码
无法连接到互联网。	电缆连接不正确。	正确连接网线。	13
	所连接设备的电源关闭。	打开所连接设备，如宽带路由器或调制解调器。	—
	宽带路由器和 / 或调制解调器的连接不正确。	正确连接宽带路由器和 / 或调制解调器。	—
	网络设定不正确。	在网络设定中设定正确的值。请参阅“网络”。	35
无法下载 BD-Live 内容。	电缆连接不正确。	正确连接网线。	13
	USB 设备连接不正确。	正确连接 USB 存储设备。检查 USB 存储设备是否连接到本机的 USB 端口。	13
	BD 碟片不支持 BD-Live。	检查 BD 碟片是否支持 BD-Live。	—
	网络设定不正确。	检查 [互联网] 的设定。	35
	USB 存储设备不兼容。	连接以 FAT16 或 FAT32 格式化的 USB 存储设备。	13
	USB 存储设备上可用空间不足。	建议连接可用空间至少为 2 GB 的 USB 存储设备。如果可用空间不足，请格式化 USB 存储设备。 请参阅碟片附送的使用说明书或咨询碟片制造商。	34 —
无法检测到 DLNA 服务器。	电缆连接不正确。	正确连接网线。	13
	所连接设备的电源关闭。	打开所连接设备，如宽带路由器或服务器。	—
	本机的存取点和服务器不相同。	确认本机和服务器连接到相同的存取点。	—
	网络设定不正确。	在网络设定中设定正确的值。请参阅“网络”。	35
	DLNA 服务器不允许本机访问。	视 DLNA 服务器而定，本机可能需要从服务器获得许可。	—
无法播放家庭网络服务器上的文件。	本机不支持此文件。	确保文件可播放。	3
	DLNA 设定不正确。	检查 DLNA 服务器的设定。	35
		播放和操作质量可能会受到家庭网络条件的影响。	—

画面上的信息

如果您试图播放的碟片不适合或操作不正确，电视屏幕上会出现以下信息。

出错信息	原因	解决方法	页码
不对应文件	本机不支持此文件。	请参阅“本机可使用的碟片 / 文件类型”。	3
区域错误!	碟片为不兼容区域码。	请参阅“区域管理信息”。	3
网络出错	本机无法连接到网络。	检查连接和网络设定。	13 35
网络 OK, 代理服务器出错。	本机无法连接到代理服务器。	请参阅“[代理服务器设置]”。	35
在安装菜单中 BD-Live 连接禁用。	BD-Live 连接被禁止。	请参阅“[BD-Live 连接]”。	35
没有检测到有效的升级文件!	无法找到升级的文件。	检查升级文件是否在正确的文件夹中。	—
升级失败!	升级失败。	检查升级文件是否损坏或不可读。	—

其他

问题	原因	解决方法	页码
忘记了密码。		未插入碟片并且播放停止时，同时按住前面板上的 ■ 和 ▲ 约 5 秒钟将本机的所有安全设定（第 35 页）设定为默认设定。电源自动关闭后，再次按 ⏻ 打开电源。	—

术语表

AIR SURROUND XTREME

本机采用新技术和运算法则，仅使用前置扬声器即可达到 5 声道环绕声，而无需使用墙壁反射。

通常，欣赏 5.1 声道环绕声需要两个前置扬声器、一个中置扬声器、两个环绕扬声器和一个超低音扬声器。

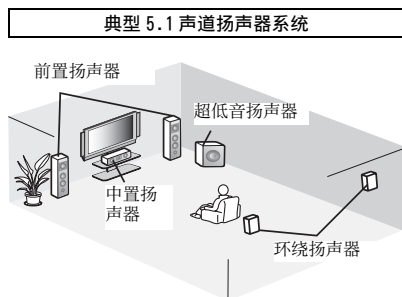

虚拟 5.1 声道

AIR SURROUND XTREME 技术仅使用前置扬声器，即可通过模拟来自中置和环绕虚拟扬声器的声音来欣赏 5.1 声道声音。

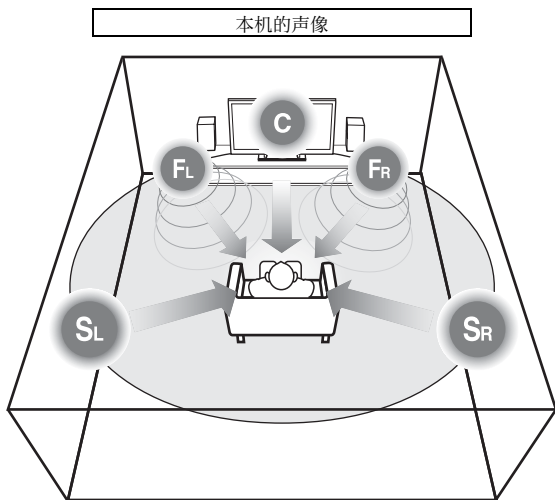

系统通过扬声器创建虚拟 5.1 声道环绕声。

C: 中置扬声器

FR、FL: 前置扬声器

SR、SL: 环绕虚拟扬声器

AVCHD

AVCHD 是可用于录制和播放高分辨率 HD 图像的高清摄像机的新格式（标准）。

BD-Live™

BD-Live 是一种利用网络连接的 BD 标准，本机使用该标准可上网下载宣传视频和其他数据。

BDMV

BDMV (Blu-ray 碟片电影、BD-MV) 是用于 BD-ROM (Blu-ray Disc 规格之一) 的应用程序格式之一。

BDMV 是相当于 DVD 规格的 DVD 视频的录制格式。

Blu-ray 3D™

使用 Blu-ray 3D 可观看全高清 3D 图像。

BONUSVIEW™

BONUSVIEW 兼容碟片可让您同时欣赏两个画面的视频子信道、音频子信道和字幕。播放时小画面显示在主画面内（画中画）。

隐藏字幕

隐藏字幕是一种字幕，它与普通字幕的区别在于这种字幕供听觉障碍者使用，而普通字幕供听觉正常者使用。普通字幕很少显示所有音频。例如，隐藏字幕显示音效（例如“电话铃声”和“脚步声”），而普通字幕则不显示。选择此设定之前，请确保碟片包含隐藏字幕信息。

彩色空间

彩色空间是可表现的色彩范围。RGB 是基于 RGB 彩色模型（红色、绿色和蓝色）的彩色空间，典型用于电脑显示器。YCbCr 是基于照度信号（Y）和两个色差信号（Cb 和 Cr）的彩色空间。

Deep Color (深色)

Deep Color (深色) 是指在显示器中使用各种色深，至少为前版 HDMI 规格中的 24 位深。此附加位深可让高清电视和其他显示器从数百万色彩增加到数十亿色彩，并消除画面色带以达到平稳音渡和色彩间的细微渐变。增加的对比率可多次表现黑白之间的更多灰色阴影。此外，Deep Color (深色) 还增加了由 RGB 或 YCbCr 彩色空间所定义的界线内的可用色彩数量。

Dolby Digital

一种由 Dolby Laboratories Inc. 研发的声音系统，当产品连接到 Dolby Digital 处理器或放大器时可对音频输出营造电影院的气氛。

Dolby Digital Plus

一种对 Dolby Digital 扩展而研发的声音系统。此音频编码技术支持 7.1 多声道环绕声。

Dolby TrueHD

Dolby TrueHD 是一种无损编码技术，最多可为下一代光碟支持 8 声道多声道环绕声。再现的声音与原始音源如出一辙。

动态范围控制

动态范围控制调节最响亮和最轻柔声音之间的范围（动态范围）以便以均衡音量播放。当难以听到对话或播放可能会干扰邻居时使用此功能。

DTS

这是由 DTS, Inc. 研发的数字声音系统，用于电影院。

DTS-HD High Resolution Audio

DTS-HD High Resolution Audio 是为下一代高清光碟格式研发的新技术。

HDMI

HDMI（高清多媒体接口）是同时支持单个数字连接上的视频和音频的接口。HDMI 连接以数字形式对配备 HDMI 电视机等 AV 组件执行高清视频信号和多声道音频信号的标准，而不降级。

信箱 (LB 4:3)

图像顶部和底部带有黑带的一种画面尺寸，便于在所连接的 4:3 电视机上观看宽屏（16:9）资料。

线性 PCM 声音

线性 PCM 是用于音频 CD 和某些 DVD 和 Blu-ray 碟片的信号录制格式。音频 CD 上的声音以 16 比特，44.1 kHz 录制。（DVD 碟片上的声音在 16 比特，48 kHz 和 24 比特，96 kHz 之间录制，BD 碟片上的声音在 16 比特，48 kHz 和 24 比特，192 kHz 之间录制。）

唇形同步

唇形同步 (Lip Sync) 是唇形同步 (lip synchronization) 的缩写，是一个技术术语，同时涉及在后期制作和传输期间保持音频和视频信号同步的问题和能力。音频和视频的延迟需要复杂的终端用户调节，HDMI 采用了自动音频和视频同步功能，使设备在没有用户交互时能够自动准确地执行此同步。

Mac 地址

Mac 地址是分配到网络设备的唯一值以便识别。

全景 (PS 4:3)

一种画面尺寸，将切掉图像边缘以便在所连接的 4:3 电视机上观看宽屏（16:9）资料。

字幕

画面底部出现文字行，翻译或誊写对话内容。众多 DVD 和 BD 碟片上均录制有字幕。

顶部菜单

在 BD 视频 /DVD 视频中，这是用于选择要播放章节和字幕语言等内容的菜单。在某些 DVD 视频中，顶部菜单也称作“标题菜单”。

x.v.Color

x.v.Color 再现前所未有的色彩范围，显示几乎所有人眼可以察觉到的色彩。

规格

播放器部分

iPod/iPhone/iPad

- 支持的 iPod/iPhone/iPad iPod classic、iPod nano (第 2 代、第 3 代、第 4 代、第 5 代和第 6 代)、iPod touch (第 1 代、第 2 代、第 3 代和第 4 代)、iPhone、iPhone 3G/3GS、iPhone 4、iPad

碟片和文件格式

- 有关支持的碟片和文件格式，请参阅第 3 页。

AUX

- 输入连接器
AUX RCA

放大器部分

- 最大输出功率 30 W + 30 W
(1 kHz, 10% THD, 6 Ω)
- 输入灵敏度 / 输入阻抗
AUX 400 mV/47 kΩ
- 总谐波失真
AUX 1 kHz/10 W 0.05 %

调谐器部分

- 调谐范围 87.50 至 108.00 MHz

输入 / 输出

- HDMI 输出 A 型连接器 × 1
480i/576i、480p/576p、720p、1080i、1080p、1080p/24Hz、Deep Color (深色)、x.v.Color、3D、ARC (音频回传通道) 支持
- 视频输出 1 V_{p-p} (75 Ω)
- USB A 型连接器 × 2
- 其他设备 以太网 × 1

一般

- 电源
[欧洲机型] AC 220-240 V, 50/60 Hz
[亚洲机型] AC 220-240 V, 50/60 Hz
[澳大利亚机型] AC 240 V, 50 Hz
[英国机型] AC 230 V, 50 Hz
[中国机型] AC 220-240 V, 50/60 Hz
[韩国机型] AC 220 V, 60 Hz
[俄罗斯机型] AC 220-240 V, 50/60 Hz
[中美洲和南美洲机型] AC 100-120 V, 50/60 Hz
- 功耗 56 W
- 待机功耗 0.5 W 或更低
- 尺寸 (宽 × 高 × 深, 包括突出部分)
..... 215 × 114.5 × 306.3 mm
- 重量 3.0 kg

规格如有变更，恕不另行通知。



该标记附加在出售到中华人民共和国的电子信息技术产品上。
环形中的数字表示的是环境保护使用期限的年数。

○ : 表示该有毒有害物质在该部件所有均质材料中的含量均在 SJ/T 11363-2006 标准规定的限量要求以下。

× : 表示该有毒有害物质至少在该部件的某一均质材料中的含量超出 SJ/T 11363-2006 标准规定的限量要求。

部件名称	有毒有害物质或元素					
	铅 (Pb)	汞 (Hg)	镉 (Cd)	六价铬 (Cr(VI))	多溴联苯 (PBB)	多溴二苯醚 (PBDE)
电路板	×	○	○	○	○	○
外壳箱体	×	○	○	○	○	○
前部面板显示器	×	○	○	○	○	○

■ 版权

- iPad、iPhone、iPod、iPod classic、iPod nano 和 iPod touch 是 Apple Inc. 在美国和其他国家注册的商标。

“Made for iPod”、“Made for iPhone”和“Made for iPad”指的是分别专用于连接 iPod、iPhone 或 iPad 的电子附件，并且已通过开发者的认证可满足 Apple 的性能标准。Apple 对本设备的运行或本设备是否符合安全和规定标准不承担责任。请注意，与 iPod、iPhone 或 iPad 配合使用该附件可能会影响无线性能。

- 视听材料可能包含受版权保护的作品，未经版权所有者的授权不得录制这些作品。请遵照您所在国家的相关法律。
- 本产品采用受美国专利和其他知识产权保护的版权保护技术。使用此版权保护技术必须获得 Rovi Corporation 的授权，限于家庭或其他有限的观看用途，除非获得 Rovi Corporation 的授权。禁止逆向工程或拆卸。
- 本产品经 AVC 专利组合许可证和 VC-1 专利组合许可证授权，允许消费者个人和非商业用于 (i) 根据 AVC 标准和 VC-1 标准 (“AVC/VC-1 视频”) 进行视频编码和 / 或 (ii) 对由从事个人和非商业活动的消费者编码和 / 或从授权提供 AVC/VC-1 视频的视频提供商处获得的 AVC/VC-1 视频进行解码。未对其他用途授予许可或暗示许可。可从 MPEG LA, LLC 获得更多信息。请访问 <http://www.mpegla.com>。
- Windows Media Player 是 Microsoft corporation 在美国和 / 或其他国家的注册商标或商标。

-  是 DVD Format/Logo Licensing Corporation 的商标。



- 由 Dolby Laboratories 授权制造。Dolby 和双 D 符号是 Dolby Laboratories 的商标。



- 由以下美国专利号: 5,956,674; 5,974,380; 6,226,616; 6,487,535; 7,212,872; 7,333,929; 7,392,195; 7,272,567 和其他美国和国际已颁发和申请中的专利授权制造。DTS-HD、符号以及 DTS-HD 与符号组合是 DTS, Inc. 的注册商标。产品包括软件。© DTS, Inc. 保留所有权利。



- Blu-ray Disc™、Blu-ray™、Blu-ray 3D™、BD-Live™、BONUSVIEW™ 和标志是 Blu-ray Disc Association 的商标。



BONUS VIEW™

- HDMI、HDMI 标志和 High-Definition Multimedia Interface 是 HDMI Licensing LLC 的商标或注册商标。



- “x.v.Color”和“x.v.Color”标志是商标。

x.v.Color

- “AVCHD”和“AVCHD”标志是 Panasonic Corporation 和 Sony Corporation 的商标。



- Java 和所有基于 Java 的商标和标志是 Sun Microsystems, Inc. 在美国和 / 或其他国家的商标或注册商标。



- DLNA 和 DLNA CERTIFIED 是 Digital Living Network Alliance 的商标和 / 或服务标志。



- 本机采用新技术和运算法则，仅使用前置扬声器即可达到 5 声道环绕声，而无需使用墙壁反射。



Information about software

This product uses the following software.

For information (copyright, etc) about each software, read the original sentences stated below.

■ About Linux, Busybox, SquashFS, LIRC, U-boot

GNU GENERAL PUBLIC LICENSE
Version 2, June 1991

Copyright (C) 1989, 1991 Free Software Foundation, Inc.
51 Franklin St, Fifth Floor, Boston, MA 02110-1301 USA

Everyone is permitted to copy and distribute verbatim copies of this license document, but changing it is not allowed.

Preamble

The licenses for most software are designed to take away your freedom to share and change it. By contrast, the GNU General Public License is intended to guarantee your freedom to share and change free software—to make sure the software is free for all its users. This General Public License applies to most of the Free Software Foundation's software and to any other program whose authors commit to using it. (Some other Free Software Foundation software is covered by the GNU Library General Public License instead.) You can apply it to your programs, too.

When we speak of free software, we are referring to freedom, not price. Our General Public Licenses are designed to make sure that you have the freedom to distribute copies of free software (and charge for this service if you wish), that you receive source code or can get it if you want it, that you can change the software or use pieces of it in new free programs; and that you know you can do these things.

To protect your rights, we need to make restrictions that forbid anyone to deny you these rights or to ask you to surrender the rights. These restrictions translate to certain responsibilities for you if you distribute copies of the software, or if you modify it. For example, if you distribute copies of such a program, whether gratis or for a fee, you must give the recipients all the rights that you have. You must make sure that they, too, receive or can get the source code. And you must show them these terms so they know their rights.

We protect your rights with two steps: (1) copyright the software, and (2) offer you this license which gives you legal permission to copy, distribute and/or modify the software. Also, for each author's protection and ours, we want to make certain that everyone understands that there is no warranty for this free software. If the software is modified by someone else and passed on, we want its recipients to know that what they have is not the original, so that any problems introduced by others will not reflect on the original authors' reputations.

Finally, any free program is threatened constantly by software patents. We wish to avoid the danger that redistributors of a free program will individually obtain patent licenses, in effect making the program proprietary. To prevent this, we have made it clear that any patent must be licensed for everyone's free use or not licensed at all. The precise terms and conditions for copying, distribution and modification follow.

GNU GENERAL PUBLIC LICENSE TERMS AND CONDITIONS FOR COPYING, DISTRIBUTION AND MODIFICATION

0. This License applies to any program or other work which contains a notice placed by the copyright holder saying it may be distributed under the terms of this General Public License. The "Program", below, refers to any such program or work, and a "work based on the Program" means either the Program or any derivative work under copyright law: that is to say, a work containing the Program or a portion of it, either verbatim or with modifications and/or translated into another language. (Hereinafter, translation is included without limitation in the term "modification".) Each licensee is addressed as "you". Activities other than copying, distribution and modification are not covered by this License; they are outside its scope. The act of running the Program is not restricted, and the output from the Program is covered only if its contents constitute a work based on the Program (independent of having been made by running the Program). Whether that is true depends on what the Program does.

1. You may copy and distribute verbatim copies of the Program's source code as you receive it, in any medium, provided that you conspicuously and appropriately publish on each copy an appropriate copyright notice and disclaimer of warranty; keep intact all the notices that refer to this License and to the absence of any warranty; and give any other recipients of the Program a copy of this License along with the Program.

You may charge a fee for the physical act of transferring a copy, and you may at your option offer warranty protection in exchange for a fee.

2. You may modify your copy or copies of the Program or any portion of it, thus forming a work based on the Program, and copy and distribute such modifications or work under the terms of Section 1 above, provided that you also meet all of these conditions:

- a) You must cause the modified files to carry prominent notices stating that you changed the files and the date of any change.
- b) You must cause any work that you distribute or publish, that in whole or in part contains or is derived from the Program or any part thereof, to be licensed as a whole at no charge to all third parties under the terms of this License.
- c) If the modified program normally reads commands interactively when run, you must cause it, when started running for such interactive use in the most ordinary way, to print or display an announcement including an appropriate copyright notice and a notice that there is no warranty (or else, saying that you provide a warranty) and that users may redistribute the program under these conditions, and telling the user how to view a copy of this License. (Exception: if the Program itself is interactive but does not normally print such an announcement, your work based on the Program is not required to print an announcement.)

These requirements apply to the modified work as a whole. If identifiable sections of that work are not derived from the Program, and can be reasonably considered independent and separate works in themselves, then this License, and its terms, do not apply to those sections when you distribute them as separate works. But when you distribute the same sections as part of a whole which is a work based on the Program, the distribution of the whole must be on the terms of this License, whose permissions for other licensees extend to the entire whole, and thus to each and every part regardless of who wrote it.

Thus, it is not the intent of this section to claim rights or contest your rights to work written entirely by you; rather, the intent is to exercise the right to control the distribution of derivative or collective works based on the Program.

In addition, mere aggregation of another work not based on the Program with the Program (or with a work based on the Program) on a volume of a storage or distribution medium does not bring the other work under the scope of this License.

3. You may copy and distribute the Program (or a work based on it, under Section 2) in object code or executable form under the terms of Sections 1 and 2 above provided that you also do one of the following:

- a) Accompany it with the complete corresponding machine-readable source code, which must be distributed under the terms of Sections 1 and 2 above on a medium customarily used for software interchange; or,
- b) Accompany it with a written offer, valid for at least three years, to give any third party, for a charge no more than your cost of physically performing source distribution, a complete machine-readable copy of the corresponding source code, to be distributed under the terms of Sections 1 and 2 above on a medium customarily used for software interchange; or,
- c) Accompany it with the information you received as to the offer to distribute corresponding source code. (This alternative is allowed only for noncommercial distribution and only if you received the program in object code or executable form with such an offer, in accord with Subsection b above.)

The source code for a work means the preferred form of the work for making modifications to it. For an executable work, complete source code means all the source code for all modules it contains, plus any associated interface definition files, plus the scripts used to control compilation and installation of the executable. However, as a special exception, the source code distributed need not include anything that is normally distributed (in either source or binary form) with the major components (compiler, kernel, and so on) of the operating system on which the executable runs, unless that component itself accompanies the executable.

If distribution of executable or object code is made by offering access to copy from a designated place, then offering equivalent access to copy the source code from the same place counts as distribution of the source code, even though third parties are not compelled to copy the source along with the object code.

4. You may not copy, modify, sublicense, or distribute the Program except as expressly provided under this License. Any attempt otherwise to copy, modify, sublicense or distribute the Program is void, and will automatically terminate your rights under this License. However, parties who have received copies, or rights, from you under this License will not have their licenses terminated so long as such parties remain in full compliance.

5. You are not required to accept this License, since you have not signed it. However, nothing else grants you permission to modify or distribute the Program or its derivative works. These actions are prohibited by law if you do not accept this License. Therefore, by modifying or distributing the Program (or any work based on the Program), you indicate your acceptance of this License to do so, and all its terms and conditions for copying, distributing or modifying the Program or works based on it.

6. Each time you redistribute the Program (or any work based on the Program), the recipient automatically receives a license from the original licensor to copy, distribute or modify the Program subject to these terms and conditions. You may not impose any further restrictions on the recipients' exercise of the rights granted herein. You are not responsible for enforcing compliance by third parties to this License.

7. If, as a consequence of a court judgment or allegation of patent infringement or for any other reason (not limited to patent issues), conditions are imposed on you (whether by court order, agreement or otherwise) that contradict the conditions of this License, they do not excuse you from the conditions of this License. If you cannot distribute so as to satisfy simultaneously your obligations under this License and any other pertinent obligations, then as a consequence you may not distribute the Program at all. For example, if a patent license would not permit royalty-free redistribution of the Program by all those who receive copies directly or indirectly through you, then the only way you could satisfy both it and this License would be to refrain entirely from distribution of the Program.

If any portion of this section is held invalid or unenforceable under any particular circumstance, the balance of the section is intended to apply and the section as a whole is intended to apply in other circumstances.

It is not the purpose of this section to induce you to infringe any patents or other property right claims or to contest validity of any such claims; this section has the sole purpose of protecting the integrity of the free software distribution system, which is implemented by public license practices. Many people have made generous contributions to the wide range of software distributed through that system in reliance on consistent application of that system; it is up to the author/donor to decide if he or she is willing to distribute software through any other system and a licensee cannot impose that choice.

This section is intended to make thoroughly clear what is believed to be a consequence of the rest of this License.

8. If the distribution and/or use of the Program is restricted in certain countries either by patents or by copyrighted interfaces, the original copyright holder who places the Program under this License may add an explicit geographical distribution limitation excluding those countries, so that distribution is permitted only in or among countries not thus excluded. In such case, this License incorporates the limitation as if written in the body of this License.

9. The Free Software Foundation may publish revised and/or new versions of the General Public License from time to time. Such new versions will be similar in spirit to the present version, but may differ in detail to address new problems or concerns.

Each version is given a distinguishing version number. If the Program specifies a version number of this License which applies to it and "any later version", you have the option of following the terms and conditions either of that version or of any later version published by the Free Software Foundation. If the Program does not specify a version number of this License, you may choose any version ever published by the Free Software Foundation.

10. If you wish to incorporate parts of the Program into other free programs whose distribution conditions are different, write to the author to ask for permission. For software which is copyrighted by the Free Software Foundation, write to the Free Software Foundation; we sometimes make exceptions for this. Our decision will be guided by the two goals of preserving the free status of all derivatives of our free software and of promoting the sharing and reuse of software generally.

NO WARRANTY

11. BECAUSE THE PROGRAM IS LICENSED FREE OF CHARGE, THERE IS NO WARRANTY FOR THE PROGRAM, TO THE EXTENT PERMITTED BY APPLICABLE LAW. EXCEPT WHEN OTHERWISE STATED IN WRITING THE COPYRIGHT HOLDERS AND/OR OTHER PARTIES PROVIDE THE PROGRAM "AS IS" WITHOUT WARRANTY OF ANY KIND, EITHER EXPRESSED OR IMPLIED, INCLUDING, BUT NOT LIMITED TO, THE IMPLIED WARRANTIES OF MERCHANTABILITY AND FITNESS FOR A PARTICULAR PURPOSE. THE ENTIRE RISK AS TO THE QUALITY AND PERFORMANCE OF THE PROGRAM IS WITH YOU. SHOULD THE PROGRAM PROVE DEFECTIVE, YOU ASSUME THE COST OF ALL NECESSARY SERVICING, REPAIR OR CORRECTION.

12. IN NO EVENT UNLESS REQUIRED BY APPLICABLE LAW OR AGREED TO IN WRITING WILL ANY COPYRIGHT HOLDER, OR ANY OTHER PARTY WHO MAY MODIFY AND/OR REDISTRIBUTE THE PROGRAM AS PERMITTED ABOVE, BE LIABLE TO YOU FOR DAMAGES, INCLUDING ANY GENERAL, SPECIAL, INCIDENTAL OR CONSEQUENTIAL DAMAGES ARISING OUT OF THE USE OR INABILITY TO USE THE PROGRAM (INCLUDING BUT NOT LIMITED TO LOSS OF DATA OR DATA BEING RENDERED INACCURATE OR LOSSES SUSTAINED BY YOU OR THIRD PARTIES OR A FAILURE OF THE PROGRAM TO OPERATE WITH ANY OTHER PROGRAMS), EVEN IF SUCH HOLDER OR OTHER PARTY HAS BEEN ADVISED OF THE POSSIBILITY OF SUCH DAMAGES.

END OF TERMS AND CONDITIONS

How to Apply These Terms to Your New Programs

If you develop a new program, and you want it to be of the greatest possible use to the public, the best way to achieve this is to make it free software which everyone can redistribute and change under these terms.

To do so, attach the following notices to the program. It is safest to attach them to the start of each source file to most effectively convey the exclusion of warranty; and each file should have at least the "copyright" line and a pointer to where the full notice is found.

<one line to give the program's name and a brief idea of what it does.>

Copyright (C) <year> <name of author>

This program is free software; you can redistribute it and/or modify it under the terms of the GNU General Public License as published by the Free Software Foundation; either version 2 of the License, or (at your option) any later version.

This program is distributed in the hope that it will be useful, but WITHOUT ANY WARRANTY; without even the implied warranty of MERCHANTABILITY or FITNESS FOR A PARTICULAR PURPOSE. See the GNU General Public License for more details.

You should have received a copy of the GNU General Public License along with this program; if not, write to the Free Software Foundation, Inc., 51 Franklin St, Fifth Floor, Boston, MA 02110-1301 USA

Also add information on how to contact you by electronic and paper mail.

If the program is interactive, make it output a short notice like this when it starts in an interactive mode:

Gnomovision version 69, Copyright (C) year name of author Gnomovision comes with ABSOLUTELY NO WARRANTY; for details type 'show w'. This is free software, and you are welcome to redistribute it under certain conditions; type 'show c' for details.

The hypothetical commands 'show w' and 'show c' should show the appropriate parts of the General Public License. Of course, the commands you use may be called something other than 'show w' and 'show c'; they could even be mouse-clicks or menu items--whatever suits your program.

You should also get your employer (if you work as a programmer) or your school, if any, to sign a "copyright disclaimer" for the program, if necessary. Here is a sample; alter the names:

Yoyodyne, Inc., hereby disclaims all copyright interest in the program 'Gnomovision' (which makes passes at compilers) written by James Hacker.

<signature of Ty Coon>, 1 April 1989

Ty Coon, President of Vice

This General Public License does not permit incorporating your program into proprietary programs. If your program is a subroutine library, you may consider it more useful to permit linking proprietary applications with the library. If this is what you want to do, use the GNU Library General Public License instead of this License..

■ About glibc, libmtp, libusb, libusb-compat, DirectFB

GNU LESSER GENERAL PUBLIC LICENSE Version 2.1, February 1999

Copyright (C) 1991, 1999 Free Software Foundation, Inc.
59 Temple Place, Suite 330, Boston, MA 02111-1307 USA

Everyone is permitted to copy and distribute verbatim copies of this license document, but changing it is not allowed.

[This is the first released version of the Lesser GPL. It also counts as the successor of the GNU Library Public License, version 2, hence the version number 2.1.]

Preamble

The licenses for most software are designed to take away your freedom to share and change it. By contrast, the GNU General Public Licenses are intended to guarantee your freedom to share and change free software--to make sure the software is free for all its users.

This license, the Lesser General Public License, applies to some specially designated software packages--typically libraries--of the Free Software Foundation and other authors who decide to use it. You can use it too, but we suggest you first think carefully about whether this license or the ordinary General Public License is the better strategy to use in any particular case, based on the explanations below.

When we speak of free software, we are referring to freedom of use, not price. Our General Public Licenses are designed to make sure that you have the freedom to distribute copies of free software (and charge for this service if you wish); that you receive source code or can get it if you want it; that you can change the software and use pieces of it in new free programs; and that you are informed that you can do these things.

To protect your rights, we need to make restrictions that forbid distributors to deny you these rights or to ask you to surrender these rights. These restrictions translate to certain responsibilities for you if you distribute copies of the library or if you modify it. For example, if you distribute copies of the library, whether gratis or for a fee, you must give the recipients all the rights that we gave you. You must make sure that they, too, receive or can get the source code. If you link other code with the library, you must provide complete object files to the recipients, so that they can relink them with the library after making changes to the library and recompiling it. And you must show them these terms so they know their rights.

We protect your rights with a two-step method: (1) we copyright the library, and (2) we offer you this license, which gives you legal permission to copy, distribute and/or modify the library.

To protect each distributor, we want to make it very clear that there is no warranty for the free library. Also, if the library is modified by someone else and passed on, the recipients should know that what they have is not the original version, so that the original author's reputation will not be affected by problems that might be introduced by others.

Finally, software patents pose a constant threat to the existence of any free program.

We wish to make sure that a company cannot effectively restrict the users of a free program by obtaining a restrictive license from a patent holder. Therefore, we insist that any patent license obtained for a version of the library must be consistent with the full freedom of use specified in this license.

Most GNU software, including some libraries, is covered by the ordinary GNU General Public License. This license, the GNU Lesser General Public License, applies to certain designated libraries, and is quite different from the ordinary General Public License. We use this license for certain libraries in order to permit linking those libraries into non-free programs.

When a program is linked with a library, whether statically or using a shared library, the combination of the two is legally speaking a combined work, a derivative of the original library. The ordinary General Public License therefore permits such linking only if the entire combination fits its criteria of freedom. The Lesser General Public License permits more lax criteria for linking other code with the library.

We call this license the "Lesser" General Public License because it does Less to protect the user's freedom than the ordinary General Public License. It also provides other free software developers Less of an advantage over competing non-free programs. These disadvantages are the reason we use the ordinary General Public License for many libraries. However, the Lesser license provides advantages in certain special circumstances.

For example, on rare occasions, there may be a special need to encourage the widest possible use of a certain library, so that it becomes a de-facto standard. To achieve this, non-free programs must be allowed to use the library. A more frequent case is that a free library does the same job as widely used non-free libraries. In this case, there is little to gain by limiting the free library to free software only, so we use the Lesser General Public License.

In other cases, permission to use a particular library in non-free programs enables a greater number of people to use a large body of free software. For example, permission to use the GNU C Library in non-free programs enables many more people to use the whole GNU operating system, as well as its variant, the GNU/Linux operating system. Although the Lesser General Public License is Less protective of the users' freedom, it does ensure that the user of a program that is linked with the Library has the freedom and the wherewithal to run that program using a modified version of the Library.

The precise terms and conditions for copying, distribution and modification follow. Pay close attention to the difference between a "work based on the library" and a "work that uses the library". The former contains code derived from the library, whereas the latter must be combined with the library in order to run.

GNU LESSER GENERAL PUBLIC LICENSE
TERMS AND CONDITIONS FOR COPYING, DISTRIBUTION AND
MODIFICATION

0. This License Agreement applies to any software library or other program which contains a notice placed by the copyright holder or other authorized party saying it may be distributed under the terms of this Lesser General Public License (also called "this License"). Each licensee is addressed as "you".

A "library" means a collection of software functions and/or data prepared so as to be conveniently linked with application programs (which use some of those functions and data) to form executables.

The "Library", below, refers to any such software library or work which has been distributed under these terms. A "work based on the Library" means either the Library or any derivative work under copyright law: that is to say, a work containing the Library or a portion of it, either verbatim or with modifications and/or translated straightforwardly into another language. (Hereinafter, translation is included without limitation in the term "modification".)

"Source code" for a work means the preferred form of the work for making modifications to it. For a library, complete source code means all the source code for all modules it contains, plus any associated interface definition files, plus the scripts used to control compilation and installation of the library.

Activities other than copying, distribution and modification are not covered by this License; they are outside its scope. The act of running a program using the Library is not restricted, and output from such a program is covered only if its contents constitute a work based on the Library (independent of the use of the Library in a tool for writing it). Whether that is true depends on what the Library does and what the program that uses the Library does.

1. You may copy and distribute verbatim copies of the Library's complete source code as you receive it, in any medium, provided that you conspicuously and appropriately publish on each copy an appropriate copyright notice and disclaimer of warranty; keep intact all the notices that refer to this License and to the absence of any warranty; and distribute a copy of this License along with the Library.

You may charge a fee for the physical act of transferring a copy, and you may at your option offer warranty protection in exchange for a fee.

2. You may modify your copy or copies of the Library or any portion of it, thus forming a work based on the Library, and copy and distribute such modifications or work under the terms of Section 1 above, provided that you also meet all of these conditions:

- a) The modified work must itself be a software library.
- b) You must cause the files modified to carry prominent notices stating that you changed the files and the date of any change.
- c) You must cause the whole of the work to be licensed at no charge to all third parties under the terms of this License.
- d) If a facility in the modified Library refers to a function or a table of data to be supplied by an application program that uses the facility, other than as an argument passed when the facility is invoked, then you must make a good faith effort to ensure that, in the event an application does not supply such function or table, the facility still operates, and performs whatever part of its purpose remains meaningful.

(For example, a function in a library to compute square roots has a purpose that is entirely well-defined independent of the application. Therefore, Subsection 2d requires that any application-supplied function or table used by this function must be optional: if the application does not supply it, the square root function must still compute square roots.)

These requirements apply to the modified work as a whole. If identifiable sections of that work are not derived from the Library, and can be reasonably considered independent and separate works in themselves, then this License, and its terms, do not apply to those sections when you distribute them as separate works. But when you distribute the same sections as part of a whole which is a work based on the Library, the distribution of the whole must be on the terms of this License, whose permissions for other licensees extend to the entire whole, and thus to each and every part regardless of who wrote it.

Thus, it is not the intent of this section to claim rights or contest your rights to work written entirely by you; rather, the intent is to exercise the right to control the distribution of derivative or collective works based on the Library.

In addition, mere aggregation of another work not based on the Library with the Library (or with a work based on the Library) on a volume of a storage or distribution medium does not bring the other work under the scope of this License.

3. You may opt to apply the terms of the ordinary GNU General Public License instead of this License to a given copy of the Library. To do this, you must alter all the notices that refer to this License, so that they refer to the ordinary GNU General Public License, version 2, instead of to this License. (If a newer version than version 2 of the ordinary GNU General Public License has appeared, then you can specify that version instead if you wish.) Do not make any other change in these notices.

Once this change is made in a given copy, it is irreversible for that copy, so the ordinary GNU General Public License applies to all subsequent copies and derivative works made from that copy.

This option is useful when you wish to copy part of the code of the Library into a program that is not a library.

4. You may copy and distribute the Library (or a portion or derivative of it, under Section 2) in object code or executable form under the terms of Sections 1 and 2 above provided that you accompany it with the complete corresponding machine-readable source code, which must be distributed under the terms of Sections 1 and 2 above on a medium customarily used for software interchange.

If distribution of object code is made by offering access to copy from a designated place, then offering equivalent access to copy the source code from the same place satisfies the requirement to distribute the source code, even though third parties are not compelled to copy the source along with the object code.

5. A program that contains no derivative of any portion of the Library, but is designed to work with the Library by being compiled or linked with it, is called a "work that uses the Library". Such a work, in isolation, is not a derivative work of the Library, and therefore falls outside the scope of this License.

However, linking a "work that uses the Library" with the Library creates an executable that is a derivative of the Library (because it contains portions of the Library), rather than a "work that uses the library". The executable is therefore covered by this License. Section 6 states terms for distribution of such executables.

When a "work that uses the Library" uses material from a header file that is part of the Library, the object code for the work may be a derivative work of the Library even though the source code is not. Whether this is true is especially significant if the work can be linked without the Library, or if the work is itself a library. The threshold for this to be true is not precisely defined by law.

If such an object file uses only numerical parameters, data structure layouts and accessors, and small macros and small inline functions (ten lines or less in length), then the use of the object file is unrestricted, regardless of whether it is legally a derivative work. (Executables containing this object code plus portions of the Library will still fall under Section 6.)

Otherwise, if the work is a derivative of the Library, you may distribute the object code for the work under the terms of Section 6. Any executables containing that work also fall under Section 6, whether or not they are linked directly with the Library itself.

6. As an exception to the Sections above, you may also combine or link a "work that uses the Library" with the Library to produce a work containing portions of the Library, and distribute that work under terms of your choice, provided that the terms permit modification of the work for the customer's own use and reverse engineering for debugging such modifications.

You must give prominent notice with each copy of the work that the Library is used in it and that the Library and its use are covered by this License. You must supply a copy of this License. If the work during execution displays copyright notices, you must include the copyright notice for the Library among them, as well as a reference directing the user to the copy of this License. Also, you must do one of these things:

- a) Accompany the work with the complete corresponding machine-readable source code for the Library including whatever changes were used in the work (which must be distributed under Sections 1 and 2 above); and, if the work is an executable linked with the Library, with the complete machine-readable "work that uses the Library", as object code and/or source code, so that the user can modify the Library and then relink to produce a modified executable containing the modified Library. (It is understood that the user who changes the contents of definitions files in the Library will not necessarily be able to recompile the application to use the modified definitions.)
- b) Use a suitable shared library mechanism for linking with the Library. A suitable mechanism is one that (1) uses at run time a copy of the library already present on the user's computer system, rather than copying library functions into the executable, and (2) will operate properly with a modified version of the library, if the user installs one, as long as the modified version is interface-compatible with the version that the work was made with.
- c) Accompany the work with a written offer, valid for at least three years, to give the same user the materials specified in Subsection 6a, above, for a charge no more than the cost of performing this distribution.
- d) If distribution of the work is made by offering access to copy from a designated place, offer equivalent access to copy the above specified materials from the same place.
- e) Verify that the user has already received a copy of these materials or that you have already sent this user a copy.

For an executable, the required form of the "work that uses the Library" must include any data and utility programs needed for reproducing the executable from it. However, as a special exception, the materials to be distributed need not include anything that is normally distributed (in either source or binary form) with the major components (compiler, kernel, and so on) of the operating system on which the executable runs, unless that component itself accompanies the executable.

It may happen that this requirement contradicts the license restrictions of other proprietary libraries that do not normally accompany the operating system. Such a contradiction means you cannot use both them and the Library together in an executable that you distribute.

7. You may place library facilities that are a work based on the Library side-by-side in a single library together with other library facilities not covered by this License, and distribute such a combined library, provided that the separate distribution of the work based on the Library and of the other library facilities is otherwise permitted, and provided that you do these two things:

- a) Accompany the combined library with a copy of the same work based on the Library, uncombined with any other library facilities. This must be distributed under the terms of the Sections above.
- b) Give prominent notice with the combined library of the fact that part of it is a work based on the Library, and explaining where to find the accompanying uncombined form of the same work.

8. You may not copy, modify, sublicense, link with, or distribute the Library except as expressly provided under this License. Any attempt otherwise to copy, modify, sublicense, link with, or distribute the Library is void, and will automatically terminate your rights under this License. However, parties who have received copies, or rights, from you under this License will not have their licenses terminated so long as such parties remain in full compliance.

9. You are not required to accept this License, since you have not signed it. However, nothing else grants you permission to modify or distribute the Library or its derivative works. These actions are prohibited by law if you do not accept this License. Therefore, by modifying or distributing the Library (or any work based on the Library), you indicate your acceptance of this License to do so, and all its terms and conditions for copying, distributing or modifying the Library or works based on it.
10. Each time you redistribute the Library (or any work based on the Library), the recipient automatically receives a license from the original licensor to copy, distribute, link with or modify the Library subject to these terms and conditions. You may not impose any further restrictions on the recipients' exercise of the rights granted herein. You are not responsible for enforcing compliance by third parties with this License.
11. If, as a consequence of a court judgment or allegation of patent infringement or for any other reason (not limited to patent issues), conditions are imposed on you (whether by court order, agreement or otherwise) that contradict the conditions of this License, they do not excuse you from the conditions of this License. If you cannot distribute so as to satisfy simultaneously your obligations under this License and any other pertinent obligations, then as a consequence you may not distribute the Library at all. For example, if a patent license would not permit royalty-free redistribution of the Library by all those who receive copies directly or indirectly through you, then the only way you could satisfy both it and this License would be to refrain entirely from distribution of the Library.

If any portion of this section is held invalid or unenforceable under any particular circumstance, the balance of the section is intended to apply, and the section as a whole is intended to apply in other circumstances.

It is not the purpose of this section to induce you to infringe any patents or other property right claims or to contest validity of any such claims; this section has the sole purpose of protecting the integrity of the free software distribution system which is implemented by public license practices. Many people have made generous contributions to the wide range of software distributed through that system in reliance on consistent application of that system; it is up to the author/donor to decide if he or she is willing to distribute software through any other system and a licensee cannot impose that choice.

This section is intended to make thoroughly clear what is believed to be a consequence of the rest of this License.

12. If the distribution and/or use of the Library is restricted in certain countries either by patents or by copyrighted interfaces, the original copyright holder who places the Library under this License may add an explicit geographical distribution limitation excluding those countries, so that distribution is permitted only in or among countries not thus excluded. In such case, this License incorporates the limitation as if written in the body of this License.
13. The Free Software Foundation may publish revised and/or new versions of the Lesser General Public License from time to time. Such new versions will be similar in spirit to the present version, but may differ in detail to address new problems or concerns.

Each version is given a distinguishing version number. If the Library specifies a version number of this License which applies to it and "any later version", you have the option of following the terms and conditions either of that version or of any later version published by the Free Software Foundation. If the Library does not specify a license version number, you may choose any version ever published by the Free Software Foundation.

14. If you wish to incorporate parts of the Library into other free programs whose distribution conditions are incompatible with these, write to the author to ask for permission. For software which is copyrighted by the Free Software Foundation, write to the Free Software Foundation; we sometimes make exceptions for this. Our decision will be guided by the two goals of preserving the free status of all derivatives of our free software and of promoting the sharing and reuse of software generally.

NO WARRANTY

15. BECAUSE THE LIBRARY IS LICENSED FREE OF CHARGE, THERE IS NO WARRANTY FOR THE LIBRARY, TO THE EXTENT PERMITTED BY APPLICABLE LAW. EXCEPT WHEN OTHERWISE STATED IN WRITING THE COPYRIGHT HOLDERS AND/OR OTHER PARTIES PROVIDE THE LIBRARY "AS IS" WITHOUT WARRANTY OF ANY KIND, EITHER EXPRESSED OR IMPLIED, INCLUDING, BUT NOT LIMITED TO, THE IMPLIED WARRANTIES OF MERCHANTABILITY AND FITNESS FOR A PARTICULAR PURPOSE. THE ENTIRE RISK AS TO THE QUALITY AND PERFORMANCE OF THE LIBRARY IS WITH YOU. SHOULD THE LIBRARY PROVE DEFECTIVE, YOU ASSUME THE COST OF ALL NECESSARY SERVICING, REPAIR OR CORRECTION.
16. IN NO EVENT UNLESS REQUIRED BY APPLICABLE LAW OR AGREED TO IN WRITING WILL ANY COPYRIGHT HOLDER, OR ANY OTHER PARTY WHO MAY MODIFY AND/OR REDISTRIBUTE THE LIBRARY AS PERMITTED ABOVE, BE LIABLE TO YOU FOR DAMAGES, INCLUDING ANY GENERAL, SPECIAL, INCIDENTAL OR CONSEQUENTIAL DAMAGES ARISING OUT OF THE USE OR INABILITY TO USE THE LIBRARY (INCLUDING BUT NOT LIMITED TO LOSS OF DATA OR DATA BEING RENDERED INACCURATE OR LOSSES SUSTAINED BY YOU OR THIRD PARTIES OR A FAILURE OF THE LIBRARY TO OPERATE WITH ANY OTHER SOFTWARE), EVEN IF SUCH HOLDER OR OTHER PARTY HAS BEEN ADVISED OF THE POSSIBILITY OF SUCH DAMAGES.

END OF TERMS AND CONDITIONS

How to Apply These Terms to Your New Libraries

If you develop a new library, and you want it to be of the greatest possible use to the public, we recommend making it free software that everyone can redistribute and change. You can do so by permitting redistribution under these terms (or, alternatively, under the terms of the ordinary General Public License).

To apply these terms, attach the following notices to the library. It is safest to attach them to the start of each source file to most effectively convey the exclusion of warranty; and each file should have at least the "copyright" line and a pointer to where the full notice is found.

```
<one line to give the library's name and a brief idea of what it does.> Copyright (C)
<year> <name of author>
```

This library is free software; you can redistribute it and/or modify it under the terms of the GNU Lesser General Public License as published by the Free Software Foundation; either version 2 of the License, or (at your option) any later version.

This library is distributed in the hope that it will be useful, but WITHOUT ANY WARRANTY; without even the implied warranty of MERCHANTABILITY or FITNESS FOR A PARTICULAR PURPOSE. See the GNU Lesser General Public License for more details.

You should have received a copy of the GNU Lesser General Public License along with this library; if not, write to the Free Software Foundation, Inc., 59 Temple Place, Suite 330, Boston, MA 02111-1307 USA

Also add information on how to contact you by electronic and paper mail.

You should also get your employer (if you work as a programmer) or your school, if any, to sign a "copyright disclaimer" for the library, if necessary. Here is a sample; alter the names:

```
Yoyodyne, Inc., hereby disclaims all copyright interest in the library 'Frob' (a
library for tweaking knobs) written by James Random Hacker.
```

```
<signature of Ty Coon>, 1 April 1990 Ty Coon, President of Vice
```

That's all there is to it!

■ About Fusion

DirectFB Fusion kernel module: introduction and API

by Niels Roest

Copyright (C) 2009 Niels Roest

This documentation is free software; you can redistribute it and/or modify it under the terms of the GNU General Public License as published by the Free Software Foundation; either version 2 of the License, or (at your option) any later version.

This program is distributed in the hope that it will be useful, but WITHOUT ANY WARRANTY; without even the implied warranty of MERCHANTABILITY or FITNESS FOR A PARTICULAR PURPOSE. See the GNU General Public License for more details.

You should have received a copy of the GNU General Public License along with this program; if not, write to the Free Software Foundation, Inc., 59 Temple Place, Suite 330, Boston, MA 02111-1307 USA

For more details see the ?le COPYING in the source distribution of Linux.

■ About openssl

Copyright (C) 1998-2008 The OpenSSL Project. All rights reserved.

Redistribution and use in source and binary forms, with or without modification, are permitted provided that the following conditions are met:

1. Redistributions of source code must retain the above copyright notice, this list of conditions and the following disclaimer.
2. Redistributions in binary form must reproduce the above copyright notice, this list of conditions and the following disclaimer in the documentation and/or other materials provided with the distribution.
3. All advertising materials mentioning features or use of this software must display the following acknowledgment:
"This product includes software developed by the OpenSSL Project for use in the OpenSSL Toolkit. (<http://www.openssl.org/>)"
4. The names "OpenSSL Toolkit" and "OpenSSL Project" must not be used to endorse or promote products derived from this software without prior written permission. For written permission, please contact openssl-core@openssl.org.
5. Products derived from this software may not be called "OpenSSL" nor may "OpenSSL" appear in their names without prior written permission of the OpenSSL Project.
6. Redistributions of any form whatsoever must retain the following acknowledgment:
"This product includes software developed by the OpenSSL Project for use in the OpenSSL Toolkit (<http://www.openssl.org/>)"

THIS SOFTWARE IS PROVIDED BY THE OpenSSL PROJECT "AS IS" AND ANY EXPRESSED OR IMPLIED WARRANTIES, INCLUDING, BUT NOT LIMITED TO, THE IMPLIED WARRANTIES OF MERCHANTABILITY AND FITNESS FOR A PARTICULAR PURPOSE ARE DISCLAIMED. IN NO EVENT SHALL THE OpenSSL PROJECT OR ITS CONTRIBUTORS BE LIABLE FOR ANY DIRECT, INDIRECT, INCIDENTAL, SPECIAL, EXEMPLARY, OR CONSEQUENTIAL DAMAGES (INCLUDING, BUT NOT LIMITED TO, PROCUREMENT OF SUBSTITUTE GOODS OR SERVICES; LOSS OF USE, DATA, OR PROFITS; OR BUSINESS INTERRUPTION) HOWEVER CAUSED AND ON ANY THEORY OF LIABILITY, WHETHER IN CONTRACT, STRICT LIABILITY, OR TORT (INCLUDING NEGLIGENCE OR OTHERWISE) ARISING IN ANY WAY OUT OF THE USE OF THIS SOFTWARE, EVEN IF ADVISED OF THE POSSIBILITY OF SUCH DAMAGE.

This product includes cryptographic software written by Eric Young (ey@cryptsoft.com). This product includes software written by Tim Hudson (tjh@cryptsoft.com).

Original SSLeay License

Copyright (C) 1995-1998 Eric Young (eay@cryptsoft.com) All rights reserved.
This package is an SSL implementation written by Eric Young (eay@cryptsoft.com).
The implementation was written so as to conform with Netscapes SSL.
This library is free for commercial and non-commercial use as long as the following conditions are adhered to. The following conditions apply to all code found in this distribution, be it the RC4, RSA, lhash, DES, etc., code; not just the SSL code. The SSL documentation included with this distribution is covered by the same copyright terms except that the holder is Tim Hudson (tjh@cryptsoft.com).
Copyright remains Eric Young's, and as such any Copyright notices in the code are not to be removed. If this package is used in a product, Eric Young should be given attribution as the author of the parts of the library used. This can be in the form of a textual message at program startup or in documentation (online or textual) provided with the package.

Redistribution and use in source and binary forms, with or without modification, are permitted provided that the following conditions are met:

1. Redistributions of source code must retain the copyright notice, this list of conditions and the following disclaimer.
2. Redistributions in binary form must reproduce the above copyright notice, this list of conditions and the following disclaimer in the documentation and/or other materials provided with the distribution.
3. All advertising materials mentioning features or use of this software must display the following acknowledgement:
"This product includes cryptographic software written by Eric Young (eay@cryptsoft.com)" The word 'cryptographic' can be left out if the routines from the library being used are not cryptographic related :-).
4. If you include any Windows specific code (or a derivative thereof) from the apps directory (application code) you must include an acknowledgement:
"This product includes software written by Tim Hudson (tjh@cryptsoft.com)"

THIS SOFTWARE IS PROVIDED BY ERIC YOUNG "AS IS" AND ANY EXPRESS OR IMPLIED WARRANTIES, INCLUDING, BUT NOT LIMITED TO, THE IMPLIED WARRANTIES OF MERCHANTABILITY AND FITNESS FOR A PARTICULAR PURPOSE ARE DISCLAIMED. IN NO EVENT SHALL THE AUTHOR OR CONTRIBUTORS BE LIABLE FOR ANY DIRECT, INDIRECT, INCIDENTAL, SPECIAL, EXEMPLARY, OR CONSEQUENTIAL DAMAGES (INCLUDING, BUT NOT LIMITED TO, PROCUREMENT OF SUBSTITUTE GOODS OR SERVICES; LOSS OF USE, DATA, OR PROFITS; OR BUSINESS INTERRUPTION) HOWEVER CAUSED AND ON ANY THEORY OF LIABILITY, WHETHER IN CONTRACT, STRICT LIABILITY, OR TORT (INCLUDING NEGLIGENCE OR OTHERWISE) ARISING IN ANY WAY OUT OF THE USE OF THIS SOFTWARE, EVEN IF ADVISED OF THE POSSIBILITY OF SUCH DAMAGE.

This licence and distribution terms for any publically available version or derivative of this code cannot be changed. i.e. this code cannot simply be copied and put under another distribution licence [including the GNU Public Licence.]

■ About zlib

Copyright notice:

(C) 1995-2004 Jean-loup Gailly and Mark Adler

This software is provided 'as-is', without any express or implied warranty. In no event will the authors be held liable for any damages arising from the use of this software. Permission is granted to anyone to use this software for any purpose, including commercial applications, and to alter it and redistribute it freely, subject to the following restrictions:

1. The origin of this software must not be misrepresented; you must not claim that you wrote the original software. If you use this software in a product, an acknowledgment in the product documentation would be appreciated but is not required.
2. Altered source versions must be plainly marked as such, and must not be misrepresented as being the original software.
3. This notice may not be removed or altered from any source distribution.

Jean-loup Gailly Mark Adler
jloup@gzip.org madler@alumni.caltech.edu
If you use the zlib library in a product, we would appreciate *not* receiving lengthy legal documents to sign. The sources are provided for free but without warranty of any kind. The library has been entirely written by Jean-loup Gailly and Mark Adler; it does not include third-party code.

If you redistribute modified sources, we would appreciate that you include in the file ChangeLog history information documenting your changes. Please read the FAQ for more information on the distribution of modified source versions.

■ About FreeType

The FreeType Project LICENSE

2006-Jan-27

Copyright 1996-2002, 2006 by

David Turner, Robert Wilhelm, and Werner Lemberg

Introduction

The FreeType Project is distributed in several archive packages; some of them may contain, in addition to the FreeType font engine, various tools and contributions which rely on, or relate to, the FreeType Project.

This license applies to all files found in such packages, and which do not fall under their own explicit license. The license affects thus the FreeType font engine, the test programs, documentation and makefiles, at the very least.

This license was inspired by the BSD, Artistic, and IJG (Independent JPEG Group) licenses, which all encourage inclusion and use of free software in commercial and freeware products alike. As a consequence, its main points are that:

- o We don't promise that this software works. However, we will be interested in any kind of bug reports. ('as is' distribution)
- o You can use this software for whatever you want, in parts or full form, without having to pay us. ('royalty-free' usage)
- o You may not pretend that you wrote this software. If you use it, or only parts of it, in a program, you must acknowledge somewhere in your documentation that you have used the FreeType code. ('credits')

We specifically permit and encourage the inclusion of this software, with or without modifications, in commercial products. We disclaim all warranties covering The FreeType Project and assume no liability related to The FreeType Project. Finally, many people asked us for a preferred form for a credit/disclaimer to use in compliance with this license. We thus encourage you to use the following text:

Portions of this software are copyright (C) <year> The FreeType Project (www.freetype.org). All rights reserved.

Please replace <year> with the value from the FreeType version you actually use.

Legal Terms

0. Definitions

Throughout this license, the terms 'package', 'FreeType Project', and 'FreeType archive' refer to the set of files originally distributed by the authors (David Turner, Robert Wilhelm, and Werner Lemberg) as the 'FreeType Project', be they named as alpha, beta or final release.

'You' refers to the licensee, or person using the project, where 'using' is a generic term including compiling the project's source code as well as linking it to form a 'program' or 'executable'. This program is referred to as 'a program using the FreeType engine'. This license applies to all files distributed in the original FreeType Project, including all source code, binaries and documentation, unless otherwise stated in the file in its original, unmodified form as distributed in the original archive. If you are unsure whether or not a particular file is covered by this license, you must contact us to verify this.

The FreeType Project is copyright (C) 1996-2000 by David Turner, Robert Wilhelm, and Werner Lemberg. All rights reserved except as specified below.

1. No Warranty

THE FREETYPE PROJECT IS PROVIDED 'AS IS' WITHOUT WARRANTY OF ANY KIND, EITHER EXPRESS OR IMPLIED, INCLUDING, BUT NOT LIMITED TO, WARRANTIES OF MERCHANTABILITY AND FITNESS FOR A PARTICULAR PURPOSE. IN NO EVENT WILL ANY OF THE AUTHORS OR COPYRIGHT HOLDERS BE LIABLE FOR ANY DAMAGES CAUSED BY THE USE OR THE INABILITY TO USE, OF THE FREETYPE PROJECT.

2. Redistribution

This license grants a worldwide, royalty-free, perpetual and irrevocable right and license to use, execute, perform, compile, display, copy, create derivative works of, distribute and sublicense the FreeType Project (in both source and object code forms) and derivative works thereof for any purpose; and to authorize others to exercise some or all of the rights granted herein, subject to the following conditions:

- o Redistribution of source code must retain this license file ('FTL.TXT') unaltered; any additions, deletions or changes to the original files must be clearly indicated in accompanying documentation. The copyright notices of the unaltered, original files must be preserved in all copies of source files.
- o Redistribution in binary form must provide a disclaimer that states that the software is based in part of the work of the FreeType Team, in the distribution documentation. We also encourage you to put an URL to the FreeType web page in your documentation, though this isn't mandatory.

These conditions apply to any software derived from or based on the FreeType Project, not just the unmodified files. If you use our work, you must acknowledge us. However, no fee need be paid to us.

3. Advertising

Neither the FreeType authors and contributors nor you shall use the name of the other for commercial, advertising, or promotional purposes without specific prior written permission.

We suggest, but do not require, that you use one or more of the following phrases to refer to this software in your documentation or advertising materials: 'FreeType Project', 'FreeType Engine', 'FreeType library', or 'FreeType Distribution'. As you have not signed this license, you are not required to accept it. However, as the FreeType Project is copyrighted material, only this license, or another one contracted with the authors, grants you the right to use, distribute, and modify it. Therefore, by using, distributing, or modifying the FreeType Project, you indicate that you understand and accept all the terms of this license.

4. Contacts

There are two mailing lists related to FreeType:

- o freetype@nongnu.org
Discusses general use and applications of FreeType, as well as future and wanted additions to the library and distribution. If you are looking for support, start in this list if you haven't found anything to help you in the documentation.
- o freetype-devel@nongnu.org
Discusses bugs, as well as engine internals, design issues, specific licenses, porting, etc. Our home page can be found at <http://www.freetype.org>

■ About Expat

Copyright (C) 1998, 1999, 2000 Thai Open Source Software Center Ltd
and Clark Cooper

Copyright (C) 2001, 2002, 2003, 2004, 2005, 2006 Expat maintainers.

Permission is hereby granted, free of charge, to any person obtaining a copy of this software and associated documentation files (the "Software"), to deal in the Software without restriction, including without limitation the rights to use, copy, modify, merge, publish, distribute, sublicense, and/or sell copies of the Software, and to permit persons to whom the Software is furnished to do so, subject to the following conditions:

The above copyright notice and this permission notice shall be included in all copies or substantial portions of the Software.

THE SOFTWARE IS PROVIDED "AS IS", WITHOUT WARRANTY OF ANY KIND, EXPRESS OR IMPLIED, INCLUDING BUT NOT LIMITED TO THE WARRANTIES OF MERCHANTABILITY, FITNESS FOR A PARTICULAR PURPOSE AND NONINFRINGEMENT. IN NO EVENT SHALL THE AUTHORS OR COPYRIGHT HOLDERS BE LIABLE FOR ANY CLAIM, DAMAGES OR OTHER LIABILITY, WHETHER IN AN ACTION OF CONTRACT, TORT OR OTHERWISE, ARISING FROM, OUT OF OR IN CONNECTION WITH THE SOFTWARE OR THE USE OR OTHER DEALINGS IN THE SOFTWARE.

■ About cURL

COPYRIGHT AND PERMISSION NOTICE

Copyright (C) 1996 - 2009, Daniel Stenberg, <daniel@haxx.se>.

All rights reserved.

Permission to use, copy, modify, and distribute this software for any purpose with or without fee is hereby granted, provided that the above copyright notice and this permission notice appear in all copies.

THE SOFTWARE IS PROVIDED "AS IS", WITHOUT WARRANTY OF ANY KIND, EXPRESS OR IMPLIED, INCLUDING BUT NOT LIMITED TO THE WARRANTIES OF MERCHANTABILITY, FITNESS FOR A PARTICULAR PURPOSE AND NONINFRINGEMENT OF THIRD PARTY RIGHTS. IN NO EVENT SHALL THE AUTHORS OR COPYRIGHT HOLDERS BE LIABLE FOR ANY CLAIM, DAMAGES OR OTHER LIABILITY, WHETHER IN AN ACTION OF CONTRACT, TORT OR OTHERWISE, ARISING FROM, OUT OF OR IN CONNECTION WITH THE SOFTWARE OR THE USE OR OTHER DEALINGS IN THE SOFTWARE.

Except as contained in this notice, the name of a copyright holder shall not be used in advertising or otherwise to promote the sale, use or other dealings in this Software without prior written authorization of the copyright holder.

■ About Independent JPEG group

The Independent JPEG Group's JPEG software

README for release 7 of 27-Jun-2009

This distribution contains the seventh public release of the Independent JPEG Group's free JPEG software. You are welcome to redistribute this software and to use it for any purpose, subject to the conditions under LEGAL ISSUES, below.

This software is the work of Tom Lane, Guido Vollbeding, Philip Gladstone, Bill Allombert, Jim Boucher, Lee Crocker, Bob Friesenbahn, Ben Jackson, Julian Minguillon, Luis Ortiz, George Phillips, Davide Rossi, Ge' Weijers, and other members of the Independent JPEG Group.

IJG is not affiliated with the official ISO JPEG standards committee.

DOCUMENTATION ROADMAP

This file contains the following sections:

OVERVIEW	General description of JPEG and the IJG software.
LEGAL ISSUES	Copyright, lack of warranty, terms of distribution.
REFERENCES	Where to learn more about JPEG.
ARCHIVE LOCATIONS	Where to find newer versions of this software.
ACKNOWLEDGMENTS	Special thanks.
FILE FORMAT WARS	Software *not* to get.
TO DO	Plans for future IJG releases.

Other documentation files in the distribution are:

User documentation:

install.txt	How to configure and install the IJG software.
usage.txt	Usage instructions for cjpeg, djpeg, jpegtran, rdjpgcom, and wrjpgcom.
*.1	Unix-style man pages for programs (same info as usage.txt).
wizard.txt	Advanced usage instructions for JPEG wizards only.
change.log	Version-to-version change highlights.

Programmer and internal documentation:

libjpeg.txt	How to use the JPEG library in your own programs.
example.c	Sample code for calling the JPEG library.
structure.txt	Overview of the JPEG library's internal structure.
filelist.txt	Road map of IJG files.
codertules.txt	Coding style rules --- please read if you contribute code.

Please read at least the files install.txt and usage.txt. Some information can also be found in the JPEG FAQ (Frequently Asked Questions) article. See ARCHIVE LOCATIONS below to find out where to obtain the FAQ article.

If you want to understand how the JPEG code works, we suggest reading one or more of the REFERENCES, then looking at the documentation files (in roughly the order listed) before diving into the code.

OVERVIEW

This package contains C software to implement JPEG image encoding, decoding, and transcoding. JPEG (pronounced "jay-peg") is a standardized compression method for full-color and gray-scale images.

This software implements JPEG baseline, extended-sequential, and progressive compression processes. Provision is made for supporting all variants of these processes, although some uncommon parameter settings aren't implemented yet. We have made no provision for supporting the hierarchical or lossless processes defined in the standard.

We provide a set of library routines for reading and writing JPEG image files, plus two sample applications "cjpeg" and "djpeg", which use the library to perform conversion between JPEG and some other popular image file formats. The library is intended to be reused in other applications.

In order to support file conversion and viewing software, we have included considerable functionality beyond the bare JPEG coding/decoding capability; for example, the color quantization modules are not strictly part of JPEG decoding, but they are essential for output to colormapped file formats or colormapped displays. These extra functions can be compiled out of the library if not required for a particular application.

We have also included "jpegtran", a utility for lossless transcoding between different JPEG processes, and "rdjpgcom" and "wrjpgcom", two simple applications for inserting and extracting textual comments in JFIF files.

The emphasis in designing this software has been on achieving portability and flexibility, while also making it fast enough to be useful. In particular, the software is not intended to be read as a tutorial on JPEG. (See the REFERENCES section for introductory material.) Rather, it is intended to be reliable, portable, industrial-strength code. We do not claim to have achieved that goal in every aspect of the software, but we strive for it.

We welcome the use of this software as a component of commercial products. No royalty is required, but we do ask for an acknowledgement in product documentation, as described under LEGAL ISSUES.

LEGAL ISSUES

In plain English:

1. We don't promise that this software works. (But if you find any bugs, please let us know!)
2. You can use this software for whatever you want. You don't have to pay us.
3. You may not pretend that you wrote this software. If you use it in a program, you must acknowledge somewhere in your documentation that you've used the IJG code.

In legalese:

The authors make NO WARRANTY or representation, either express or implied, with respect to this software, its quality, accuracy, merchantability, or fitness for a particular purpose. This software is provided "AS IS", and you, its user, assume the entire risk as to its quality and accuracy.

This software is copyright (C) 1991-2009, Thomas G. Lane, Guido Vollbeding.

All Rights Reserved except as specified below.

Permission is hereby granted to use, copy, modify, and distribute this software (or portions thereof) for any purpose, without fee, subject to these conditions:

- (1) If any part of the source code for this software is distributed, then this README file must be included, with this copyright and no-warranty notice unaltered; and any additions, deletions, or changes to the original files must be clearly indicated in accompanying documentation.
- (2) If only executable code is distributed, then the accompanying documentation must state that "this software is based in part on the work of the Independent JPEG Group".
- (3) Permission for use of this software is granted only if the user accepts full responsibility for any undesirable consequences; the authors accept NO LIABILITY for damages of any kind.

These conditions apply to any software derived from or based on the IJG code, not just to the unmodified library. If you use our work, you ought to acknowledge us.

Permission is NOT granted for the use of any IJG author's name or company name in advertising or publicity relating to this software or products derived from it. This software may be referred to only as "the Independent JPEG Group's software".

We specifically permit and encourage the use of this software as the basis of commercial products, provided that all warranty or liability claims are assumed by the product vendor.

ansi2knr.c is included in this distribution by permission of L. Peter Deutsch, sole proprietor of its copyright holder, Aladdin Enterprises of Menlo Park, CA. ansi2knr.c is NOT covered by the above copyright and conditions, but instead by the usual distribution terms of the Free Software Foundation; principally, that you must include source code if you redistribute it. (See the file ansi2knr.c for full details.) However, since ansi2knr.c is not needed as part of any program generated from the IJG code, this does not limit you more than the foregoing paragraphs do.

The Unix configuration script "configure" was produced with GNU Autoconf. It is copyright by the Free Software Foundation but is freely distributable. The same holds for its supporting scripts (config.guess, config.sub, ltmain.sh). Another support script, install-sh, is copyright by X Consortium but is also freely distributable.

The IJG distribution formerly included code to read and write GIF files. To avoid entanglement with the Unisys LZW patent, GIF reading support has been removed altogether, and the GIF writer has been simplified to produce "uncompressed GIFs". This technique does not use the LZW algorithm; the resulting GIF files are larger than usual, but are readable by all standard GIF decoders.

We are required to state that

"The Graphics Interchange Format(c) is the Copyright property of
CompuServe Incorporated. GIF(sm) is a Service Mark property of
CompuServe Incorporated."

REFERENCES

We recommend reading one or more of these references before trying to understand the innards of the JPEG software.

The best short technical introduction to the JPEG compression algorithm is

Wallace, Gregory K. "The JPEG Still Picture Compression Standard",

(Adjacent articles in that issue discuss MPEG motion picture compression, applications of JPEG, and related topics.) If you don't have the CACM issue handy, a PostScript file containing a revised version of Wallace's article is available at <http://www.iijg.org/files/wallace.ps.gz>. The file (actually a preprint for an article that appeared in IEEE Trans. Consumer Electronics) omits the sample images that appeared in CACM, but it includes corrections and some added material. Note: the Wallace article is copyright ACM and IEEE, and it may not be used for commercial purposes.

A somewhat less technical, more leisurely introduction to JPEG can be found in "The Data Compression Book" by Mark Nelson and Jean-loup Gailly, published by M&T Books (New York), 2nd ed. 1996, ISBN 1-55851-434-1. This book provides good explanations and example C code for a multitude of compression methods including JPEG. It is an excellent source if you are comfortable reading C code but don't know much about data compression in general. The book's JPEG sample code is far from industrial-strength, but when you are ready to look at a full implementation, you've got one here...

The best currently available description of JPEG is the textbook "JPEG Still Image Data Compression Standard" by William B. Pennebaker and Joan L. Mitchell, published by Van Nostrand Reinhold, 1993, ISBN 0-442-01272-1. Price US\$59.95, 638 pp. The book includes the complete text of the ISO JPEG standards (DIS 10918-1 and draft DIS 10918-2).

Although this is by far the most detailed and comprehensive exposition of JPEG publicly available, we point out that it is still missing an explanation of the most essential properties and algorithms of the underlying DCT technology. If you think that you know about DCT-based JPEG after reading this book, then you are in delusion. The real fundamentals and corresponding potential of DCT-based JPEG are not publicly known so far, and that is the reason for all the mistaken developments taking place in the image coding domain.

The original JPEG standard is divided into two parts, Part 1 being the actual specification, while Part 2 covers compliance testing methods. Part 1 is titled "Digital Compression and Coding of Continuous-tone Still Images, Part 1: Requirements and guidelines" and has document numbers ISO/IEC IS 10918-1, ITU-T T.81. Part 2 is titled "Digital Compression and Coding of Continuous-tone Still Images, Part 2: Compliance testing" and has document numbers ISO/IEC IS 10918-2, ITU-T T.83. The JPEG standard does not specify all details of an interchangeable file format. For the omitted details we follow the "JFIF" conventions, revision 1.02. A copy of the JFIF spec is available from:

Literature Department
C-Cube Microsystems, Inc.
1778 McCarthy Blvd.
Milpitas, CA 95035
phone (408) 944-6300, fax (408) 944-6314

A PostScript version of this document is available at <http://www.iijg.org/files/jfif.ps.gz>. There is also a plain text version at <http://www.iijg.org/files/jfif.txt.gz>, but it is missing the figures.

The TIFF 6.0 file format specification can be obtained by FTP from <ftp://ftp.sgi.com/graphics/tiff/TIFF6.ps.gz>. The JPEG incorporation scheme from the TIFF 6.0 spec of 3-June-92 has a number of serious problems. IJG does not recommend use of the TIFF 6.0 design (TIFF Compression tag 6). Instead, we recommend the JPEG design proposed by TIFF Technical Note #2 (Compression tag 7). Copies of this Note can be obtained from <http://www.iijg.org/files/>. It is expected that the next revision of the TIFF spec will replace the 6.0 JPEG design with the Note's design. Although IJG's own code does not support TIFF/JPEG, the free libtiff library uses our library to implement TIFF/JPEG per the Note.

ARCHIVE LOCATIONS

The "official" archive site for this software is www.iijg.org. The most recent released version can always be found there in directory "files". This particular version will be archived as <http://www.iijg.org/files/jpegsrc.v7.tar.gz>, and in Windows-compatible "zip" archive format as <http://www.iijg.org/files/jpegsrc7.zip>.

The JPEG FAQ (Frequently Asked Questions) article is a source of some general information about JPEG. It is available on the World Wide Web at <http://www.faqs.org/faqs/jpeg-faq/> and other news.answers archive sites, including the official news.answers archive at rtfm.mit.edu:ftp://rtfm.mit.edu/pub/usenet/news.answers/jpeg-faq/. If you don't have Web or FTP access, send e-mail to mail-server@rtfm.mit.edu with body

send usenet/news.answers/jpeg-faq/part1
send usenet/news.answers/jpeg-faq/part2

ACKNOWLEDGMENTS

Thank to Juergen Bruder of the Georg-Cantor-Organization at the Martin-Luther-University Halle for providing me with a copy of the common DCT algorithm article, only to find out that I had come to the same result in a more direct and comprehensible way with a more generative approach.

Thank to Istvan Sebestyen and Joan L. Mitchell for inviting me to the ITU JPEG (Study Group 16) meeting in Geneva, Switzerland.

Thank to Thomas Wiegand and Gary Sullivan for inviting me to the Joint Video Team (MPEG & ITU) meeting in Geneva, Switzerland.

Thank to John Korejwa and Massimo Ballerini for inviting me to fruitful consultations in Boston, MA and Milan, Italy.

Thank to Hendrik Elstner, Roland Fassauer, and Simone Zuck for corresponding business development.

Thank to Nico Zschach and Dirk Stelling of the technical support team at the Digital Images company in Halle for providing me with extra equipment for configuration tests.

Thank to Richard F. Lyon (then of Foveon Inc.) for fruitful communication about JPEG configuration in Sigma Photo Pro software.

Last but not least special thank to Thomas G. Lane for the original design and development of this singular software package.

FILE FORMAT WARS

The ISO JPEG standards committee actually promotes different formats like JPEG-2000 or JPEG-XR which are incompatible with original DCT-based JPEG and which are based on faulty technologies. IJG therefore does not and will not support such momentary mistakes (see REFERENCES). We have little or no sympathy for the promotion of these formats. Indeed, one of the original reasons for developing this free software was to help force convergence on common, interoperable format standards for JPEG files. Don't use an incompatible file format! (In any case, our decoder will remain capable of reading existing JPEG image files indefinitely.)

TO DO

v7 is basically just a necessary interim release, paving the way for a major breakthrough in image coding technology with the next v8 package which is scheduled for release in the year 2010.

Please send bug reports, offers of help, etc. to jpeg-info@jpegclub.org.

■ About International Components for Unicode

ICU License - ICU 1.8.1 and later

COPYRIGHT AND PERMISSION NOTICE

Copyright (C) 1995-2003 International Business Machines Corporation and others
All rights reserved.

Permission is hereby granted, free of charge, to any person obtaining a copy of this software and associated documentation files (the "Software"), to deal in the Software without restriction, including without limitation the rights to use, copy, modify, merge, publish, distribute, and/or sell copies of the Software, and to permit persons to whom the Software is furnished to do so, provided that the above copyright notice(s) and this permission notice appear in all copies of the Software and that both the above copyright notice(s) and this permission notice appear in supporting documentation.

THE SOFTWARE IS PROVIDED "AS IS", WITHOUT WARRANTY OF ANY KIND, EXPRESS OR IMPLIED, INCLUDING BUT NOT LIMITED TO THE WARRANTIES OF MERCHANTABILITY, FITNESS FOR A PARTICULAR PURPOSE AND NONINFRINGEMENT OF THIRD PARTY RIGHTS. IN NO EVENT SHALL THE COPYRIGHT HOLDER OR HOLDERS INCLUDED IN THIS NOTICE BE LIABLE FOR ANY CLAIM, OR ANY SPECIAL INDIRECT OR CONSEQUENTIAL DAMAGES, OR ANY DAMAGES WHATSOEVER RESULTING FROM LOSS OF USE, DATA OR PROFITS, WHETHER IN AN ACTION OF CONTRACT, NEGLIGENCE OR OTHER TORTIOUS ACTION, ARISING OUT OF OR IN CONNECTION WITH THE USE OR PERFORMANCE OF THIS SOFTWARE.

Except as contained in this notice, the name of a copyright holder shall not be used in advertising or otherwise to promote the sale, use or other dealings in this Software without prior written authorization of the copyright holder.

All trademarks and registered trademarks mentioned herein are the property of their respective owners.

■ About libpng

This copy of the libpng notices is provided for your convenience. In case of any discrepancy between this copy and the notices in the file png.h that is included in the libpng distribution, the latter shall prevail.

COPYRIGHT NOTICE, DISCLAIMER, and LICENSE:

If you modify libpng you may insert additional notices immediately following this sentence. This code is released under the libpng license.

libpng versions 1.2.6, August 15, 2004, through 1.2.45, July 7, 2011, are Copyright (C) 2004, 2006-2009 Glenn Randers-Pehrson, and are distributed according to the same disclaimer and license as libpng-1.2.5 with the following individual added to the list of Contributing Authors

Cosmin Truta

libpng versions 1.0.7, July 1, 2000, through 1.2.5 - October 3, 2002, are Copyright (C) 2000-2002 Glenn Randers-Pehrson, and are distributed according to the same disclaimer and license as libpng-1.0.6 with the following individuals added to the list of Contributing Authors

Simon-Pierre Cadieux

Eric S. Raymond

Gilles Vollant

and with the following additions to the disclaimer:

There is no warranty against interference with your enjoyment of the library or against infringement. There is no warranty that our efforts or the library will fulfill any of your particular purposes or needs. This library is provided with all faults, and the entire risk of satisfactory quality, performance, accuracy, and effort is with the user.

libpng versions 0.97, January 1998, through 1.0.6, March 20, 2000, are Copyright (C) 1998, 1999 Glenn Randers-Pehrson, and are distributed according to the same disclaimer and license as libpng-0.96, with the following individuals added to the list of Contributing Authors:

Tom Lane

Glenn Randers-Pehrson

Willem van Schaik

libpng versions 0.89, June 1996, through 0.96, May 1997, are Copyright (C) 1996, 1997 Andreas Dilger Distributed according to the same disclaimer and license as libpng-0.88, with the following individuals added to the list of Contributing Authors:

John Bowler

Kevin Bracey

Sam Bushell

Magnus Holmgren

Greg Roelofs

Tom Tanner

libpng versions 0.5, May 1995, through 0.88, January 1996, are Copyright (C) 1995, 1996 Guy Eric Schalnat, Group 42, Inc.
For the purposes of this copyright and license, "Contributing Authors" is defined as the following set of individuals:

Andreas Dilger
Dave Martindale
Guy Eric Schalnat
Paul Schmidt
Tim Wegner

The PNG Reference Library is supplied "AS IS". The Contributing Authors and Group 42, Inc. disclaim all warranties, expressed or implied, including, without limitation, the warranties of merchantability and of fitness for any purpose. The Contributing Authors and Group 42, Inc. assume no liability for direct, indirect, incidental, special, exemplary, or consequential damages, which may result from the use of the PNG Reference Library, even if advised of the possibility of such damage. Permission is hereby granted to use, copy, modify, and distribute this source code, or portions hereof, for any purpose, without fee, subject to the following restrictions:

1. The origin of this source code must not be misrepresented.
2. Altered versions must be plainly marked as such and must not be misrepresented as being the original source.
3. This Copyright notice may not be removed or altered from any source or altered source distribution.

The Contributing Authors and Group 42, Inc. specifically permit, without fee, and encourage the use of this source code as a component to supporting the PNG file format in commercial products. If you use this source code in a product, acknowledgment is not required but would be appreciated.

A "png_get_copyright" function is available, for convenient use in "about" boxes and the like:

```
printf("%s",png_get_copyright(NULL));
```

Also, the PNG logo (in PNG format, of course) is supplied in the files "pngbar.png" and "pngbar.jpg (88x31)" and "pngnow.png" (98x31).

Libpng is OSI Certified Open Source Software. OSI Certified Open Source is a certification mark of the Open Source Initiative.

Glenn Randers-Pehrson
glennrp at users.sourceforge.net
July 7, 2011

■ About tinymce

www.sourceforge.net/projects/tinymce

Original code (2.0 and earlier)copyright (C) 2000-2006 Lee Thomason (www.grinninglizard.com)

This software is provided 'as-is', without any express or implied warranty. In no event will the authors be held liable for any damages arising from the use of this software.

Permission is granted to anyone to use this software for any purpose, including commercial applications, and to alter it and redistribute it freely, subject to the following restrictions:

1. The origin of this software must not be misrepresented; you must not claim that you wrote the original software. If you use this software in a product, an acknowledgment in the product documentation would be appreciated but is not required.
2. Altered source versions must be plainly marked as such, and must not be misrepresented as being the original software.
3. This notice may not be removed or altered from any source distribution.

■ About dtoa and strtod

The author of this software is David M. Gay.

Copyright (C) 1991, 2000, 2001 by Lucent Technologies.

Permission to use, copy, modify, and distribute this software for any purpose without fee is hereby granted, provided that this entire notice is included in all copies of any software which is or includes a copy or modification of this software and in all copies of the supporting documentation for such software.

THIS SOFTWARE IS BEING PROVIDED "AS IS", WITHOUT ANY EXPRESS OR IMPLIED WARRANTY. IN PARTICULAR, NEITHER THE AUTHOR NOR LUCENT MAKES ANY REPRESENTATION OR WARRANTY OF ANY KIND CONCERNING THE MERCHANTABILITY OF THIS SOFTWARE OR ITS FITNESS FOR ANY PARTICULAR PURPOSE.

■ About gSOAP

gSOAP Public License

Version 1.3b

The gSOAP public license is derived from the Mozilla Public License (MPL1.1). The sections that were deleted from the original MPL1.1 text are 1.0.1, 2.1.(c),(d), 2.2.(c),(d), 8.2.(b), 10, and 11.

Section 3.8 was added. The modified sections are 2.1.(b), 2.2.(b), 3.2 (simplified), 3.5 (deleted the last sentence), and 3.6 (simplified).

This license applies to the gSOAP software package, with the exception of the wsdl2h source code located in `gsoap/wsdl`, all code generated by `wsdl2h`, the UDDI source code `gsoap/uddi2`, and the Web server sample source code `samples/webserver`. To use all of the software commercially, a commercial license has to be obtained from www.genivia.com.

1 DEFINITIONS.

1.0.1.

1.1. "Contributor" means each entity that creates or contributes to the creation of Modifications.

1.2. "Contributor Version" means the combination of the Original Code, prior Modifications used by a Contributor, and the Modifications made by that particular Contributor.

1.3. "Covered Code" means the Original Code, or Modifications or the combination of the Original Code, and Modifications, in each case including portions thereof.

1.4. "Electronic Distribution Mechanism" means a mechanism generally accepted in the software development community for the electronic transfer of data.

1.5. "Executable" means Covered Code in any form other than Source Code.

1.6. "Initial Developer" means the individual or entity identified as the Initial Developer in the Source Code notice required by Exhibit A.

1.7. "Larger Work" means a work which combines Covered Code or portions thereof with code not governed by the terms of this License.

1.8. "License" means this document.

1.8.1. "Licensable" means having the right to grant, to the maximum extent possible, whether at the time of the initial grant or subsequently acquired, any and all of the rights conveyed herein.

1.9. "Modifications" means any addition to or deletion from the substance or structure of either the Original Code or any previous Modifications. When Covered Code is released as a series of files, a Modification is: A.

Any addition to or deletion from the contents of a file containing Original Code or previous Modifications. B.

Any new file that contains any part of the Original Code, or previous Modifications.

1.10. "Original Code" means Source Code of computer software code which is described in the Source Code notice required by Exhibit A as Original Code, and which, at the time of its release under this License is not already Covered Code governed by this License.

1.10.1. "Patent Claims" means any patent claim(s), now owned or hereafter acquired, including without limitation, method, process, and apparatus claims, in any patent Licensable by grantor.

<http://www.cs.fsu.edu/~engelen/license.html>

1.11. "Source Code" means the preferred form of the Covered Code for making modifications to it, including all modules it contains, plus any associated interface definition files, scripts used to control compilation and installation of an Executable, or source code differential comparisons against either the Original Code or another well known, available Covered Code of the Contributor's choice. The Source Code can be in a compressed or archival form, provided the appropriate decompression or de-archiving software is widely available for no charge.

1.12. "You" (or "Your") means an individual or a legal entity exercising rights under, and complying with all of the terms of, this License or a future version of this License issued under Section 6.1. For legal entities, "You" includes any entity which controls, is controlled by, or is under common control with You. For purposes of this definition, "control" means (a) the power, direct or indirect, to cause the direction or management of such entity, whether by contract or otherwise, or (b) ownership of more than fifty percent (50%) of the outstanding shares or beneficial ownership of such entity.

2 SOURCE CODE LICENSE.

2.1. The Initial Developer Grant. The Initial Developer hereby grants You a world-wide, royalty-free, non-exclusive license, subject to third party intellectual property claims:

(a) under intellectual property rights (other than patent or trademark) Licensable by Initial Developer to use, reproduce, modify, display, perform, sublicense and distribute the Original Code (or portions thereof) with or without Modifications, and/or as part of a Larger Work; and

(b) under patents now or hereafter owned or controlled by Initial Developer, to make, have made, use and sell ("offer to sell and import") the Original Code, Modifications, or portions thereof, but solely to the extent that any such patent is reasonably necessary to enable You to utilize, alone or in combination with other software, the Original Code, Modifications, or any combination or portions thereof.

(c)

(d)

2.2. Contributor Grant.

Subject to third party intellectual property claims, each Contributor hereby grants You a world-wide, royalty-free, non-exclusive license

(a)

under intellectual property rights (other than patent or trademark) Licensable by Contributor, to use, reproduce, modify, display, perform, sublicense and distribute the Modifications created by such Contributor (or portions thereof) either on an unmodified basis, with other Modifications, as Covered Code and/or as part of a Larger Work; and

(b)

under patents now or hereafter owned or controlled by Contributor, to make, have made, use and sell ("offer to sell and import") the Contributor Version (or portions thereof), but solely to the extent that any such patent is reasonably necessary to enable You to utilize, alone or in combination with other software, the Contributor Version (or portions thereof).

(c)

(d)

3 DISTRIBUTION OBLIGATIONS.

3.1. Application of License.

The Modifications which You create or to which You contribute are governed by the terms of this License, including without limitation Section 2.2. The Source Code version of Covered Code may be distributed only under the terms of this License or a future version of this License released under Section 6.1, and You must include a copy of this License with every copy of the Source Code You distribute. You may not offer or impose any terms on any Source Code version that alters or restricts the applicable version of this License or the recipients' rights hereunder. However, You may include an additional document offering the additional rights described in Section 3.5.

3.2. Availability of Source Code.

Any Modification created by You will be provided to the Initial Developer in Source Code form and are subject to the terms of the License.

3.3. Description of Modifications.

You must cause all Covered Code to which You contribute to contain a file documenting the changes You made to create that Covered Code and the date of any change. You must include a prominent statement that the Modification is derived, directly or indirectly, from Original Code provided by the Initial Developer and including the name of the Initial Developer in (a) the Source Code, and (b) in any notice in an Executable version or related documentation in which You describe the origin or ownership of the Covered Code.

3.4. Intellectual Property Matters.

(a) Third Party Claims.

If Contributor has knowledge that a license under a third party's intellectual property rights is required to exercise the rights granted by such Contributor under Sections 2.1 or 2.2, Contributor must include a text file with the Source Code distribution titled "LEGAL" which describes the claim and the party making the claim in sufficient detail that a recipient will know whom to contact. If Contributor obtains such knowledge after the Modification is made available as described in Section 3.2, Contributor shall promptly modify the LEGAL file in all copies Contributor makes available thereafter and shall take other steps (such as notifying appropriate mailing lists or newsgroups) reasonably calculated to inform those who received the Covered Code that new knowledge has been obtained.

(b) Contributor APIs.

If Contributor's Modifications include an application programming interface and Contributor has knowledge of patent licenses which are reasonably necessary to implement that API, Contributor must also include this information in the LEGAL file.

(c) Representations.

Contributor represents that, except as disclosed pursuant to Section 3.4(a) above, Contributor believes that Contributor's Modifications are Contributor's original creation(s) and/or Contributor has sufficient rights to grant the rights conveyed by this License.

3.5. Required Notices.

You must duplicate the notice in Exhibit A in each file of the Source Code. If it is not possible to put such notice in a particular Source Code file due to its structure, then You must include such notice in a location (such as a relevant directory) where a user would be likely to look for such a notice. If You created one or more Modification(s) You may add your name as a Contributor to the notice described in Exhibit A. You must also duplicate this License in any documentation for the Source Code where You describe recipients' rights or ownership rights relating to Covered Code. You may choose to offer, and to charge a fee for, warranty, support, indemnity or liability obligations to one or more recipients of Covered Code. However, You may do so only on Your own behalf, and not on behalf of the Initial Developer or any Contributor.

3.6. Distribution of Executable Versions.

You may distribute Covered Code in Executable form only if the requirements of Section 3.1-3.5 have been met for that Covered Code. You may distribute the Executable version of Covered Code or ownership rights under a license of Your choice, which may contain terms different from this License, provided that You are in compliance with the terms of this License and that the license for the Executable version does not attempt to limit or alter the recipient's rights in the Source Code version from the rights set forth in this License. If You distribute the Executable version under a different license You must make it absolutely clear that any terms which differ from this License are offered by You alone, not by the Initial Developer or any Contributor. If you distribute executable versions containing Covered Code as part of a product, you must reproduce the notice in Exhibit B in the documentation and/or other materials provided with the product.

3.7. Larger Works.

You may create a Larger Work by combining Covered Code with other code not governed by the terms of this License and distribute the Larger Work as a single product. In such a case, You must make sure the requirements of this License are fulfilled for the Covered Code.

3.8. Restrictions.

You may not remove any product identification, copyright, proprietary notices or labels from gSOAP.

4 INABILITY TO COMPLY DUE TO STATUTE OR REGULATION.

If it is impossible for You to comply with any of the terms of this License with respect to some or all of the Covered Code due to statute, judicial order, or regulation then You must: (a) comply with the terms of this License to the maximum extent possible; and (b) describe the limitations and the code they affect. Such description must be included in the LEGAL file described in Section 3.4 and must be included with all distributions of the Source Code, Except to the extent prohibited by statute or regulation, such description must be sufficiently detailed for a recipient of ordinary skill to be able to understand it.

5 APPLICATION OF THIS LICENSE.

This License applies to code to which the Initial Developer has attached the notice in Exhibit A and to related Covered Code.

6 VERSIONS OF THE LICENSE.

6.1. New Versions.

Grantor may publish revised and/or new versions of the License from time to time. Each version will be given a distinguishing version number.

6.2. Effect of New Versions.

Once Covered Code has been published under a particular version of the License, You may always continue to use it under the terms of that version. You may also choose to use such Covered Code under the terms of any subsequent version of the License.

6.3. Derivative Works.

If You create or use a modified version of this License (which you may only do in order to apply it to code which is not already Covered Code governed by this License), You must (a) rename Your license so that the phrase "gSOAP" or any confusingly similar phrase do not appear in your license (except to note that your license differs from this License) and (b) otherwise make it clear that Your version of the license contains terms which differ from the gSOAP Public License. (Filling in the name of the Initial Developer, Original Code or Contributor in the notice described in Exhibit A shall not of themselves be deemed to be modifications of this License.)

7 DISCLAIMER OF WARRANTY.

COVERED CODE IS PROVIDED UNDER THIS LICENSE ON AN "AS IS" BASIS, WITHOUT WARRANTY OF ANY KIND, WHETHER EXPRESS, IMPLIED OR STATUTORY, INCLUDING, WITHOUT LIMITATION, THE IMPLIED WARRANTIES OF MERCHANTABILITY, OF FITNESS FOR A PARTICULAR PURPOSE, NON-INFRINGEMENT OF THIRD PARTY INTELLECTUAL PROPERTY RIGHTS, AND ANY WARRANTY THAT MAY ARISE BY REASON OF TRADE USAGE, CUSTOM, OR COURSE OF DEALING, WITHOUT LIMITING THE FOREGOING, YOU ACKNOWLEDGE THAT THE SOFTWARE IS PROVIDED "AS IS" AND THAT THE AUTHORS DO NOT WARRANT THE SOFTWARE WILL RUN UNINTERRUPTED OR ERROR FREE. LIMITED LIABILITY THE ENTIRE RISK AS TO RESULTS AND PERFORMANCE OF THE SOFTWARE IS ASSUMED BY YOU. UNDER NO CIRCUMSTANCES WILL THE AUTHORS BE LIABLE FOR ANY SPECIAL, INDIRECT, INCIDENTAL, EXEMPLARY OR CONSEQUENTIAL DAMAGES OF ANY KIND OR NATURE WHATSOEVER, WHETHER BASED ON CONTRACT, WARRANTY, TORT (INCLUDING NEGLIGENCE), STRICT LIABILITY OR OTHERWISE, ARISING OUT OF OR IN ANY WAY RELATED TO THE SOFTWARE, EVEN IF THE AUTHORS HAVE BEEN ADVISED ON THE POSSIBILITY OF SUCH DAMAGE OR IF SUCH DAMAGE COULD HAVE BEEN REASONABLY FORESEEN, AND NOTWITHSTANDING ANY FAILURE OF ESSENTIAL PURPOSE OF ANY EXCLUSIVE REMEDY PROVIDED. SUCH LIMITATION ON DAMAGES INCLUDES, BUT IS NOT LIMITED TO, DAMAGES FOR LOSS OF GOODWILL, LOST PROFITS, LOSS OF DATA OR SOFTWARE, WORK STOPPAGE, COMPUTER FAILURE OR MALFUNCTION OR IMPAIRMENT OF OTHER GOODS. IN NO EVENT WILL THE AUTHORS BE LIABLE FOR THE COSTS OF PROCUREMENT OF SUBSTITUTE SOFTWARE OR SERVICES. YOU ACKNOWLEDGE THAT THIS SOFTWARE IS NOT DESIGNED FOR USE IN ON-LINE EQUIPMENT IN HAZARDOUS ENVIRONMENTS SUCH AS OPERATION OF NUCLEAR FACILITIES, AIRCRAFT NAVIGATION OR CONTROL, OR LIFE-CRITICAL APPLICATIONS. THE AUTHORS EXPRESSLY DISCLAIM ANY LIABILITY RESULTING FROM USE OF THE SOFTWARE IN ANY SUCH ON-LINE EQUIPMENT IN HAZARDOUS ENVIRONMENTS AND ACCEPTS NO LIABILITY IN RESPECT OF ANY ACTIONS OR CLAIMS BASED ON THE USE OF THE SOFTWARE IN ANY SUCH ON-LINE EQUIPMENT IN HAZARDOUS ENVIRONMENTS BY YOU. FOR PURPOSES OF THIS PARAGRAPH, THE TERM "LIFE-CRITICAL APPLICATION" MEANS AN APPLICATION IN WHICH THE FUNCTIONING OR MALFUNCTIONING OF THE SOFTWARE MAY RESULT DIRECTLY OR INDIRECTLY IN PHYSICAL INJURY OR LOSS OF HUMAN LIFE. THIS DISCLAIMER OF WARRANTY CONSTITUTES AN ESSENTIAL PART OF THIS LICENSE. NO USE OF ANY COVERED CODE IS AUTHORIZED HEREUNDER EXCEPT UNDER THIS DISCLAIMER.

8 TERMINATION.

8.1.

This License and the rights granted hereunder will terminate automatically if You fail to comply with terms herein and fail to cure such breach within 30 days of becoming aware of the breach. All sublicenses to the Covered Code which are properly granted shall survive any termination of this License. Provisions which, by their nature, must remain in effect beyond the termination of this License shall survive.

8.2.

8.3.

If You assert a patent infringement claim against Participant alleging that such Participant's Contributor Version directly or indirectly infringes any patent where such claim is resolved (such as by license or settlement) prior to the initiation of patent infringement litigation, then the reasonable value of the licenses granted by such Participant under Sections 2.1 or 2.2 shall be taken into account in determining the amount or value of any payment or license.

8.4.

In the event of termination under Sections 8.1 or 8.2 above, all end user license agreements (excluding distributors and resellers) which have been validly granted by You or any distributor hereunder prior to termination shall survive termination.

9 LIMITATION OF LIABILITY.

UNDER NO CIRCUMSTANCES AND UNDER NO LEGAL THEORY, WHETHER TORT (INCLUDING NEGLIGENCE), CONTRACT, OR OTHERWISE, SHALL YOU, THE INITIAL DEVELOPER, ANY OTHER CONTRIBUTOR, OR ANY DISTRIBUTOR OF COVERED CODE, OR ANY SUPPLIER OF ANY OF SUCH PARTIES, BE LIABLE TO ANY PERSON FOR ANY INDIRECT, SPECIAL, INCIDENTAL, OR CONSEQUENTIAL DAMAGES OF ANY CHARACTER INCLUDING, WITHOUT LIMITATION, DAMAGES FOR LOSS OF GOODWILL, WORK STOPPAGE, COMPUTER FAILURE OR MALFUNCTION, OR ANY AND ALL OTHER COMMERCIAL DAMAGES OR LOSSES, EVEN IF SUCH PARTY SHALL HAVE BEEN INFORMED OF THE POSSIBILITY OF SUCH DAMAGES. THIS LIMITATION OF LIABILITY SHALL NOT APPLY TO LIABILITY FOR DEATH OR PERSONAL INJURY RESULTING FROM SUCH PARTY'S NEGLIGENCE TO THE EXTENT APPLICABLE LAW PROHIBITS SUCH LIMITATION. SOME JURISDICTIONS DO NOT ALLOW THE EXCLUSION OR LIMITATION OF INCIDENTAL OR CONSEQUENTIAL DAMAGES, SO THIS EXCLUSION AND LIMITATION MAY NOT APPLY TO YOU.

10 U.S. GOVERNMENT END USERS.

11 MISCELLANEOUS.

12 RESPONSIBILITY FOR CLAIMS.

As between Initial Developer and the Contributors, each party is responsible for claims and damages arising, directly or indirectly, out of its utilization of rights under this License and You agree to work with Initial Developer and Contributors to distribute such responsibility on an equitable basis. Nothing herein is intended or shall be deemed to constitute any admission of liability.

EXHIBIT A.

"The contents of this file are subject to the gSOAP Public License Version 1.3 (the "License"); you may not use this file except in compliance with the License. You may obtain a copy of the License at <http://www.cs.fsu.edu/engelen/soaplicense.html>

Software distributed under the License is distributed on an "AS IS" basis, WITHOUT WARRANTY OF ANY KIND, either express or implied. See the License for the specific language governing rights and limitations under the License.

The Original Code of the gSOAP Software is: stdsoap.h, stdsoap2.h, stdsoap.c, stdsoap2.c, stdsoap.cpp, stdsoap2.cpp, soapcpp2.h, soapcpp2.c, soapcpp2_lex.l, soapcpp2_yacc.y, error2.h, error2.c, symbol2.c, init2.c, soapdoc2.html, and soapdoc2.pdf, httpget.h, httpget.c, stl.h, stldeque.h, stllist.h, stlvector.h, stlset.h.

The Initial Developer of the Original Code is Robert A. van Engelen. Portions created by Robert A. van Engelen are Copyright (C) 2001-2004 Robert A. van Engelen, Genivia inc. All Rights Reserved. Contributor(s):

"-----"
[Note: The text of this Exhibit A may differ slightly from the text of the notices in the Source Code files of the Original code. You should use the text of this Exhibit A rather than the text found in the Original Code Source Code for Your Modifications.] EXHIBIT B.

"Part of the software embedded in this product is gSOAP software. Portions created by gSOAP are Copyright (C) 2001-2009 Robert A. van Engelen, Genivia inc. All Rights Reserved. THE SOFTWARE IN THIS PRODUCT WAS IN PART PROVIDED BY GENIVIA INC AND ANY EXPRESS OR IMPLIED WARRANTIES, INCLUDING, BUT NOT LIMITED TO, THE IMPLIED WARRANTIES OF MERCHANTABILITY AND FITNESS FOR A PARTICULAR PURPOSE ARE DISCLAIMED. IN NO EVENT SHALL THE AUTHOR BE LIABLE FOR ANY DIRECT, INDIRECT, INCIDENTAL, SPECIAL, EXEMPLARY, OR CONSEQUENTIAL DAMAGES (INCLUDING, BUT NOT LIMITED TO, PROCUREMENT OF SUBSTITUTE GOODS OR SERVICES; LOSS OF USE, DATA, OR PROFITS; OR BUSINESS INTERRUPTION) HOWEVER CAUSED AND ON ANY THEORY OF LIABILITY, WHETHER IN CONTRACT, STRICT LIABILITY, OR TORT (INCLUDING NEGLIGENCE OR OTHERWISE) ARISING IN ANY WAY OUT OF THE USE OF THIS SOFTWARE, EVEN IF ADVISED OF THE POSSIBILITY OF SUCH DAMAGE." <http://www.cs.fsu.edu/~engelen/license.html>

■ About fonts

Fonts are (c) Bitstream (see below). DejaVu changes are in public domain. Glyphs imported from Arev fonts are (c) Tavmjong Bah (see below)

Bitstream Vera Fonts Copyright

Copyright (c) 2003 by Bitstream, Inc. All Rights Reserved. Bitstream Vera is a trademark of Bitstream, Inc.

Permission is hereby granted, free of charge, to any person obtaining a copy of the fonts accompanying this license ("Fonts") and associated documentation files (the "Font Software"), to reproduce and distribute the Font Software, including without limitation the rights to use, copy, merge, publish, distribute, and/or sell copies of the Font Software, and to permit persons to whom the Font Software is furnished to do so, subject to the following conditions:

The above copyright and trademark notices and this permission notice shall be included in all copies of one or more of the Font Software typefaces.

The Font Software may be modified, altered, or added to, and in particular the designs of glyphs or characters in the Fonts may be modified and additional glyphs or characters may be added to the Fonts, only if the fonts are renamed to names not containing either the words "Bitstream" or the word "Vera".

This License becomes null and void to the extent applicable to Fonts or Font Software that has been modified and is distributed under the "Bitstream Vera" names.

The Font Software may be sold as part of a larger software package but no copy of one or more of the Font Software typefaces may be sold by itself.

THE FONT SOFTWARE IS PROVIDED "AS IS", WITHOUT WARRANTY OF ANY KIND, EXPRESS OR IMPLIED, INCLUDING BUT NOT LIMITED TO ANY WARRANTIES OF MERCHANTABILITY, FITNESS FOR A PARTICULAR PURPOSE AND NONINFRINGEMENT OF COPYRIGHT, PATENT, TRADEMARK, OR OTHER RIGHT. IN NO EVENT SHALL BITSTREAM OR THE GNOME FOUNDATION BE LIABLE FOR ANY CLAIM, DAMAGES OR OTHER LIABILITY, INCLUDING ANY GENERAL, SPECIAL, INDIRECT, INCIDENTAL, OR CONSEQUENTIAL DAMAGES, WHETHER IN AN ACTION OF CONTRACT, TORT OR OTHERWISE, ARISING FROM, OUT OF THE USE OR INABILITY TO USE THE FONT SOFTWARE OR FROM OTHER DEALINGS IN THE FONT SOFTWARE.

Except as contained in this notice, the names of Gnome, the Gnome Foundation, and Bitstream Inc., shall not be used in advertising or otherwise to promote the sale, use or other dealings in this Font Software without prior written authorization from the Gnome Foundation or Bitstream Inc., respectively. For further information, contact: fonts at gnome dot org.

Arev Fonts Copyright

Copyright (c) 2006 by Tavmjong Bah. All Rights Reserved.

Permission is hereby granted, free of charge, to any person obtaining a copy of the fonts accompanying this license ("Fonts") and associated documentation files (the "Font Software"), to reproduce and distribute the modifications to the Bitstream Vera Font Software, including without limitation the rights to use, copy, merge, publish, distribute, and/or sell copies of the Font Software, and to permit persons to whom the Font Software is furnished to do so, subject to the following conditions:

The above copyright and trademark notices and this permission notice shall be included in all copies of one or more of the Font Software typefaces.

The Font Software may be modified, altered, or added to, and in particular the designs of glyphs or characters in the Fonts may be modified and additional glyphs or characters may be added to the Fonts, only if the fonts are renamed to names not containing either the words "Tavmjong Bah" or the word "Arev".

This License becomes null and void to the extent applicable to Fonts or Font Software that has been modified and is distributed under the "Tavmjong Bah Arev" names.

The Font Software may be sold as part of a larger software package but no copy of one or more of the Font Software typefaces may be sold by itself.

THE FONT SOFTWARE IS PROVIDED "AS IS", WITHOUT WARRANTY OF ANY KIND, EXPRESS OR IMPLIED, INCLUDING BUT NOT LIMITED TO ANY WARRANTIES OF MERCHANTABILITY, FITNESS FOR A PARTICULAR PURPOSE AND NONINFRINGEMENT OF COPYRIGHT, PATENT, TRADEMARK, OR OTHER RIGHT. IN NO EVENT SHALL TAVMJONG BAH BE LIABLE FOR ANY CLAIM, DAMAGES OR OTHER LIABILITY, INCLUDING ANY GENERAL, SPECIAL, INDIRECT, INCIDENTAL, OR CONSEQUENTIAL DAMAGES, WHETHER IN AN ACTION OF CONTRACT, TORT OR OTHERWISE, ARISING FROM, OUT OF THE USE OR INABILITY TO USE THE FONT SOFTWARE OR FROM OTHER DEALINGS IN THE FONT SOFTWARE.

Except as contained in this notice, the name of Tavmjong Bah shall not be used in advertising or otherwise to promote the sale, use or other dealings in this Font Software without prior written authorization from Tavmjong Bah. For further information, contact: tavmjong @ free. fr.

