

YAMAHA

Synthesizer

CS-15

● OWNER'S MANUAL

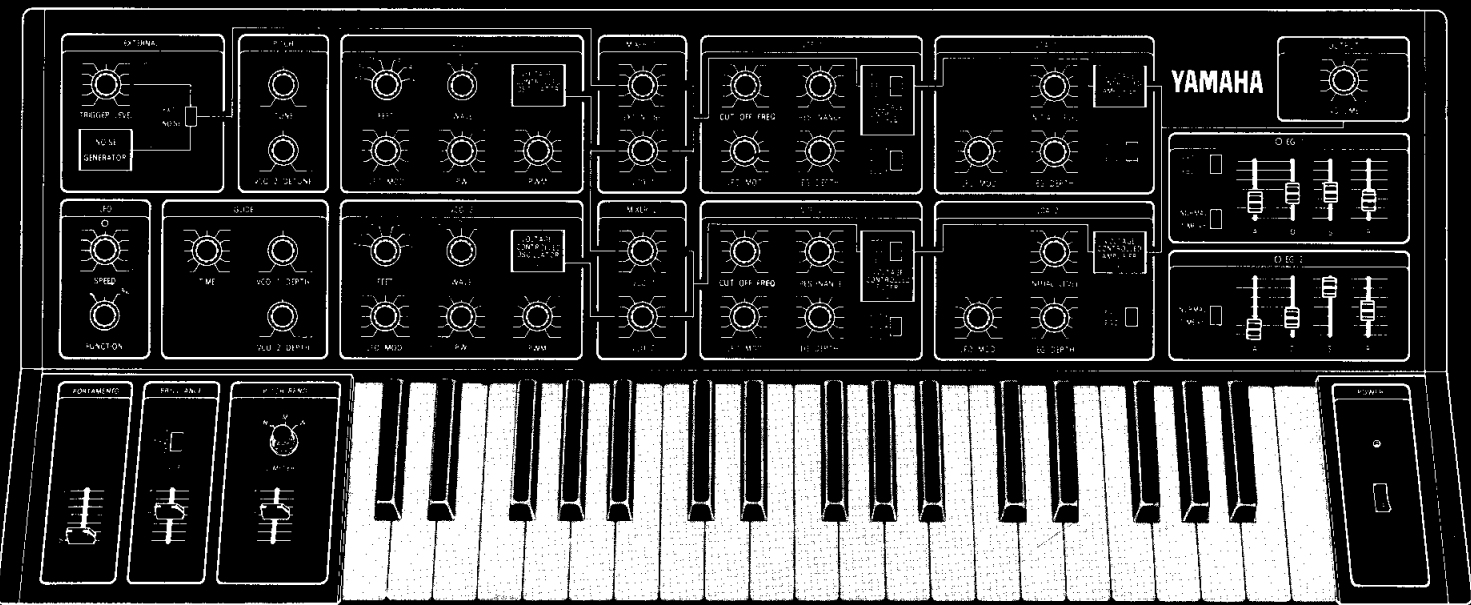

SYNTHESIZER CS-15

The synthesizer that has brought a new and creative sound to the world of music is now a popular musical instrument, widely played by music minded people in all styles of music.

The CS-15 is a superb synthesizer unexcelled in operation and performance. It is designed by YAMAHA employing the latest IC technology, and it is destined to be used by you to explore your own fantastic music universe!

The CS-15 is equipped with 2 complete VCO, VCF and VCA systems as well as 2 EGs. To make full use of its functions and to discover your original sound, please read the contents of this Owner's Manual carefully.

■ Points of Attention

● Installation

Avoid places subjected to direct sunshine, high humidity, or extremely dusty locations. Never use the synthesizer near fire or heat-producing objects, such as on top of a power amplifier.

● Cleaning

When cleaning the set, do not wipe the panel or keyboard with thinner or other cleaning liquids, as this may leave stains or cause discoloration. Always use only a soft and dry piece of cloth.

● Connections

Connections to an amplifier or other equipment must be made appropriately and with due care, as wrong connections may lead to damage in the synthesizer or amplifier.

● Volume

The volume level should always be set with care, as the application of excessive input to the amplifier may cause damage to the amplifier or speakers.

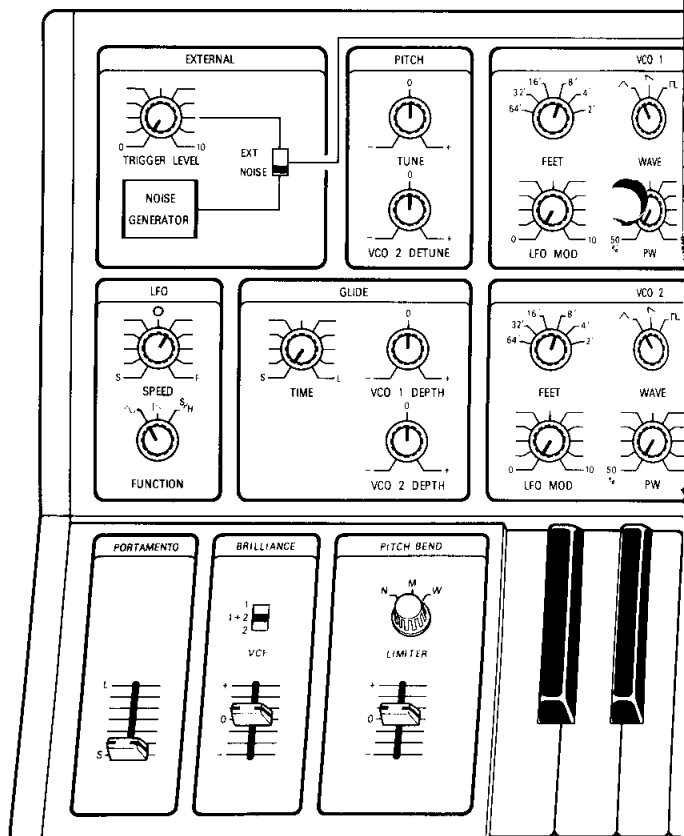

■ CONTENTS

WHAT IS A SYNTHESIZER4
 CONNECTIONS6
 FUNCTIONS
 HOW TO PRODUCE SOUND7
 PITCH/GLIDE8
 VCO9
 MIXER/EXTERNAL10
 VCF11
 VCF/VCA12
 EG13
 LFO/EFFECT14
 EFFECT/EXTERNAL15
 CONNECTING TWO SYNTHESIZERS.....16
 APPLICATIONS
 IMPORTANT POINTS17
 HOW TO CREATE THE TRUMPET SOUND18
 USE OF TWO SYSTEMS20
 USE OF EFFECT CONTROLS21
 BLOCK DIAGRAM22
 SOUND MEMO23
 SPECIFICATIONS25
 TROUBLESHOOTING26

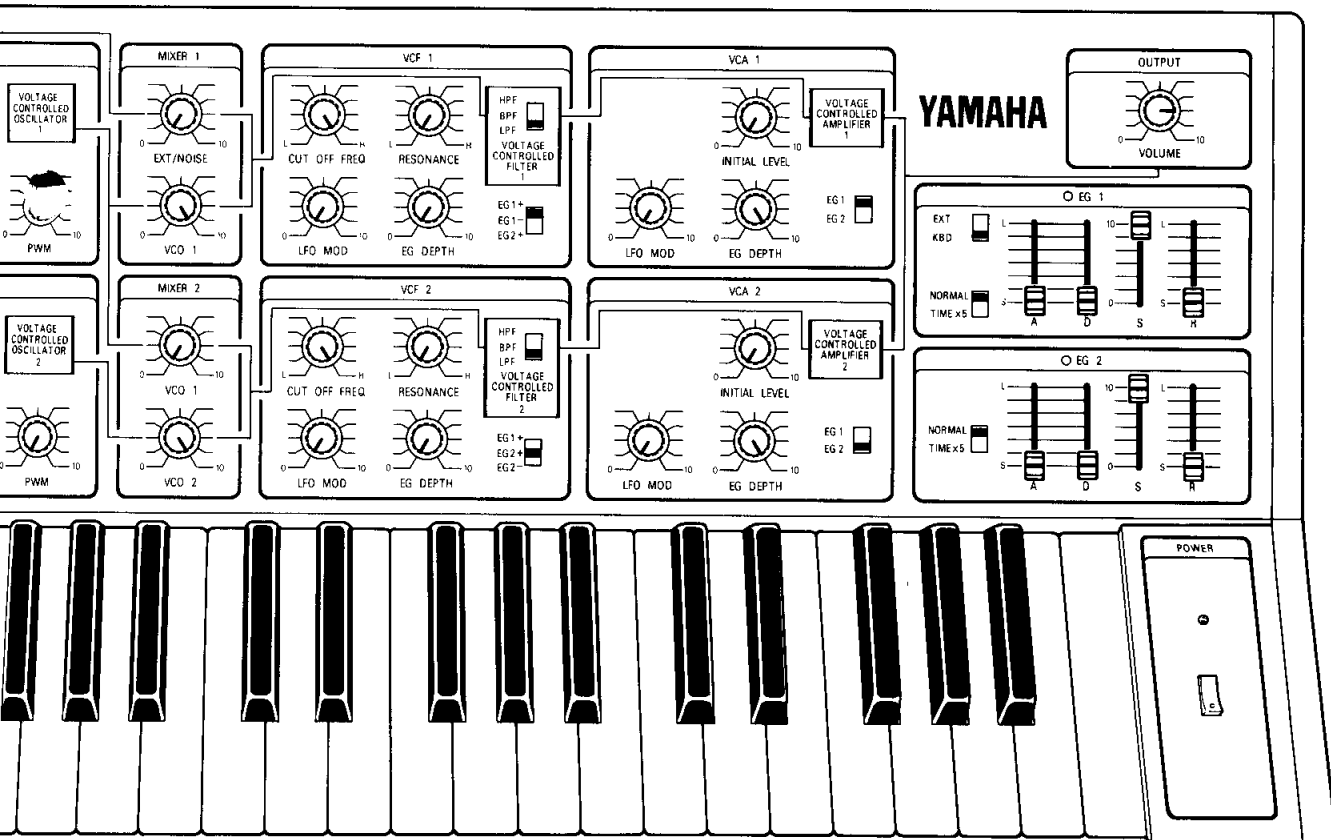

WHAT IS A SYNTHESIZER

Unlike other musical instruments, the synthesizer has no fixed sound of its own. Thus, before playing it, it is necessary to shape the sounds. But with the synthesizer you will be able to create, with your own hands and by synthesizing sounds, a new type of sound that can never be made by any other musical instrument.

• THE THREE ELEMENTS OF SOUND

How does a synthesizer make sounds? Before explaining the principle of the synthesizer, let us consider what kind of properties sound has.

Sound produced by musical instruments such as the piano or the guitar has a certain pitch, according to the key or string used. It is possible to change the pitch by changing the length of the vibrating portion of the string. In this case, the string's number of vibrations per second also changes. The slower the string vibrates, the lower the pitch becomes. In this way, it is possible to express the difference in pitch by the number of vibrations (frequency).

PITCHES

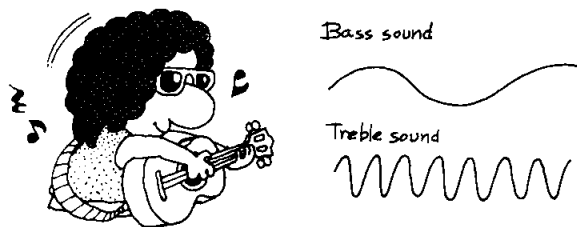

However, between the sound of a piano and that of a guitar there is a difference in tone even when both sounds are of the same pitch: no one will mistake the sound of the piano for that of the guitar. This is because there is a difference in the way the strings vibrate (the vibration waveform), due to the difference in the arrangement by which the sounds are generated, and because of the difference in the shape and size of the musical instruments.

TONES

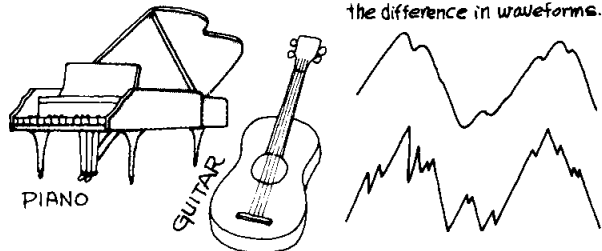

Furthermore, even when both the pitch and tone quality are the same there can be a difference in sound, such as when the same key of the piano is hit in a forcible or a gentle manner. It is easy to discern the two sounds from each other because of the

magnitude (volume) of the sound. This is because a difference will be produced in the size and amplitude of the string's vibrations, due to the intensity with which it has been struck.

In this way, sounds produced by musical instruments have such elements as pitch, tone and volume, whose differences add to the sound's characteristics. These elements are referred to as "the three elements of sound", which may also be considered as the difference in frequency, waveform and amplitude.

• TEMPORAL CHANGE IN SOUNDS

However, the elements which render sounds with certain characteristics are not confined to these three. Taking the piano for example, the volume will reach maximum the instant the key is hit, then will decrease gradually. When the finger is released from the keyboard, the sound will fade out. In the case of the organ, the action of depressing the key will cause the volume to rise to a certain level, which will be retained for the duration the keyboard is depressed. The sound will fade away when the finger is released from the key.

ENVELOPE

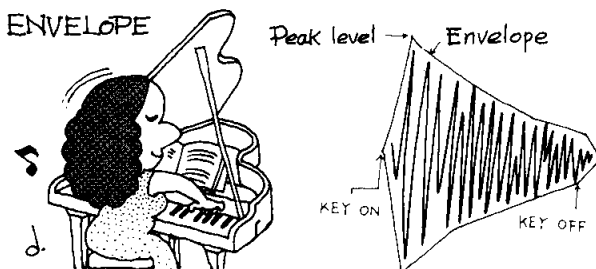

In such musical instruments as the trumpet, for example, the harmonic spectrum changes together with the change in volume. The tone changes too, along with the passage of time.

Thus, the sounds of musical instruments undergo delicate changes from the time the sound is generated to the time it fades away. These temporal changes are known as an "envelope."

• HARMONICS

What must we do in order to produce electrical sounds that have the above mentioned three elements of sound, these are pitch, tone and volume, and which vary with time (have an envelope)? Before going into the matter, let us view sound again from a different angle.

As regards the vibration waveforms by which the tone is determined, it is known that any given waveform can be considered as consisting of a certain number of sine waves. In other words, all waveforms can be produced by combining a large number of sine waves. For example, let us overlap over a single sine wave waveforms having an integral multiple

number of vibrations, such as 2-fold, 3-fold, and so on. It is seen that the waveform will gradually come to resemble a sawtooth waveform. In addition to this, it is apparent that this sawtooth waveform has a cycle similar to that of the sine wave that has been used as the basis. The sine wave with the basic cycle is referred to as the fundamental and the sine waves of harmonic overtones as the harmonics. In the case of musical instruments, the way in which harmonics are contained in sounds will depend on the arrangement by which sounds are generated. When we discuss the difference in tones (waveforms), it is the same as discussing what kind of harmonics the sounds contain.

Accordingly, one can express the three elements of sound in another manner, that is, as 1) pitch, 2) the manner in which harmonics are contained (harmonic structure) and 3) volume.

SAWTOOTH WAVE

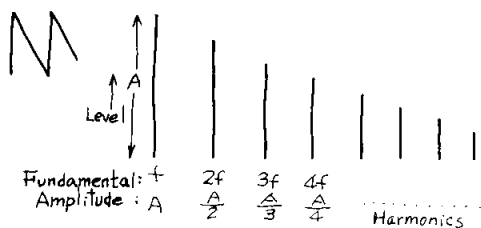

• STRUCTURE OF THE SYNTHESIZER

In the synthesizer, sounds are synthesized by electronically effecting control on the four properties of sound (the three elements of sound plus the envelope), dividing it into 4 blocks.

Control of pitch is effected by the VCO, that of harmonic spectrum by the VCF, that of volume by the VCA and that of envelope by the EG (envelope generator). The following describes the functions of each block.

• VCO

The VCO block produces sound sources of frequencies corresponding to the intervals of the keyboard. The sound source waveforms produced by the VCO are sawtooth waves and square waves that include many harmonics in a regular manner. These waves are oscillated, using an electronic circuit.

• VCF

The VCF block determines the tone, changing the harmonic spectrum of the sound sources by cutting, or emphasizing, certain parts of the harmonics by passing the sound sources through filters. The boundary between the portion that passes through the filter and the portion that is cut off is known as the cut-off frequency. The VCF creates the characteristic harmonic spectrum, by varying the cut-off frequency.

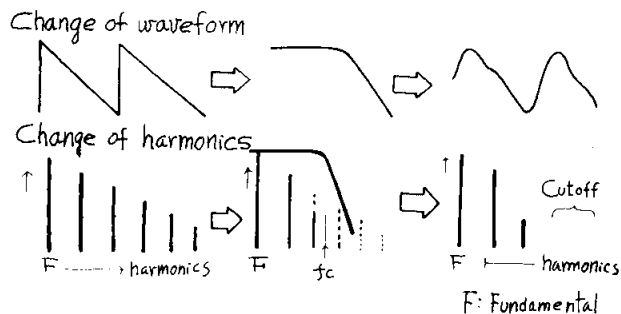

In addition to adjusting the cut-off frequency by means of a knob, the tone is caused to undergo a temporal change (from the time the sound is generated to the time it ceases) to give it an "envelope". This is accomplished by effecting control on the filter's cut-off frequencies by means of the envelope generator.

• VCA

The VCA block adds an "envelope" to the volume. The process starting from the generation of the sound up to the point the sound gradually fades away is governed by the envelope generator's ATTACK TIME, DECAY TIME, SUSTAIN LEVEL, RELEASE TIME (A.D.S.R.), changing the amplification degree of the VCA amplifier.

VCA and Envelope

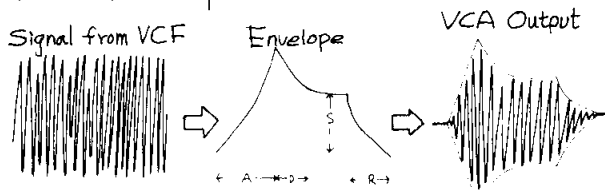

The signals from the VCO reach the VCF where they undergo a change with regard to their harmonic spectrum by being passed through a filter. The signals, now containing certain tone characteristics, are given a volume "envelope" at the VCA and then fed out. In this way, all elements of the properties of sound are controlled electronically, by utilizing the three elements of sound and the "envelope." The synthesizer has, in addition to the blocks described above, other blocks such as the LFO which permit further changes in the sounds. But in this case too, the job is performed by controlling the three elements of sound and the envelope.

We hope that the points described in this section may be helpful to understand the immense possibilities and great pleasure awaiting you on a path that will lead you into a new world of music using a totally new musical instrument, the synthesizer.

CONNECTIONS

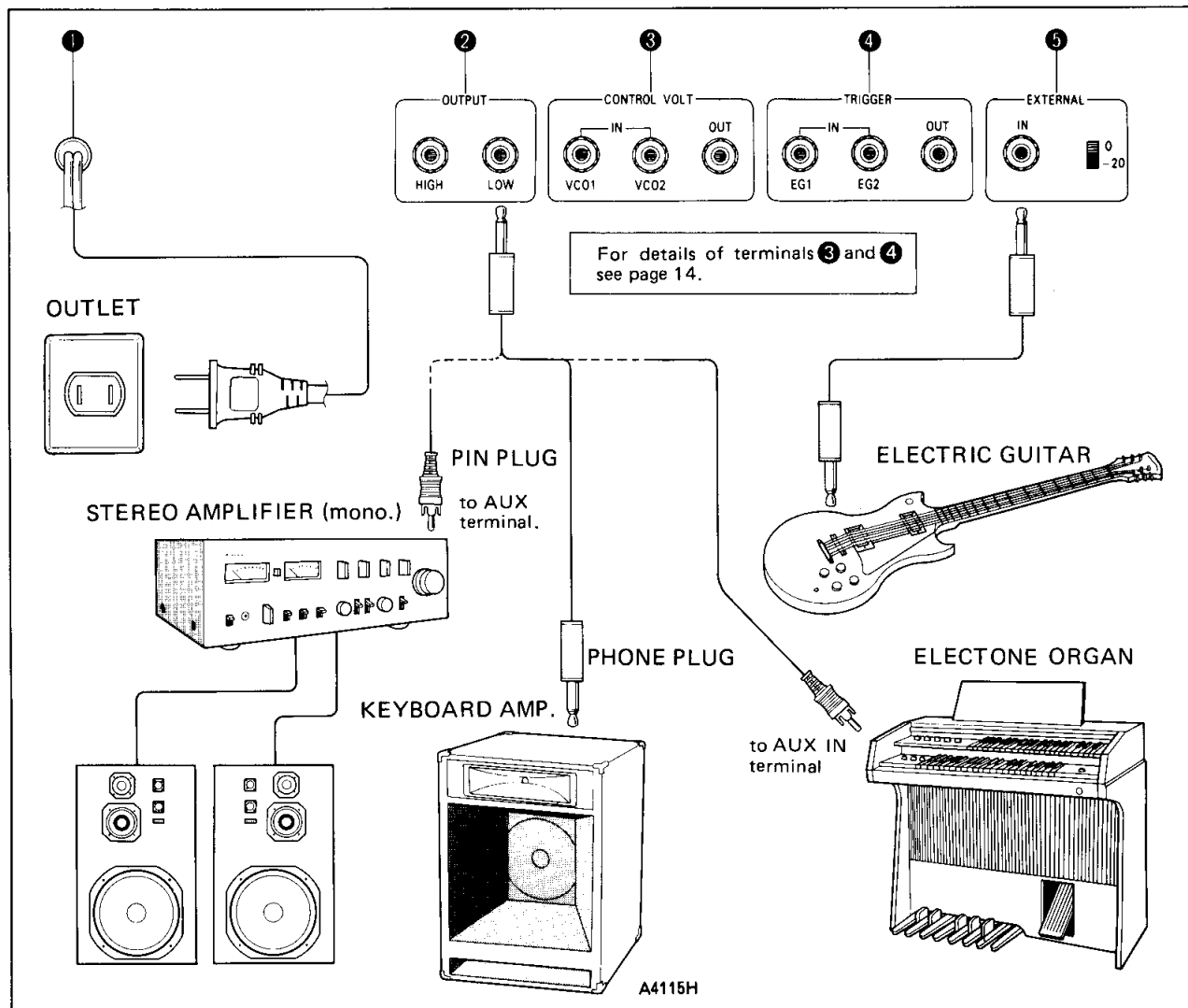

1 POWER CORD

Connect the power cord plug to an AC outlet.

2 OUTPUT

These are output terminals to be connected to the amplifier. Use the HIGH or LOW level terminal according to input sensitivity of the amplifier. Connections can be made to a keyboard amplifier, guitar amplifier, stereo amplifier, etc.

3 CONTROL VOLT 4 TRIGGER

By connecting the set with another synthesizers, such as CS-5, CS-10*, CS-15, CS-30*, CS-30L*, etc. having CONTROL VOLT (or KEY VOLT), and TRIGGER terminals, this set can be used as a multi-system synthesizer. See page 16 for further details.

*CS-10, CS-30 and CS-30L are not available in certain region.

- Never apply an excessive input (5V or more) to the CONTROL VOLT IN terminal, since this will cause damage to the synthesizer.

5 EXTERNAL

By connecting an electric guitar or an electric piano to this terminal, a synthesizer effect can be given to such sound sources. For further details see page 16.

FUNCTIONS HOW TO PRODUCE SOUND

The panel layout of the CS-15 is as follows: Two VCO → VCF → VCA systems are situated above each other in the center and the blocks controlling these in its vicinity. The thin lines combining each block indicate the signal flow. First we will merely indicate the basic setting for producing sounds experimentally to check the synthesizer or amplifier.

This is an example in which triangle waves are generated in one system (upper side) and square waves in the other system. We will describe this setting first and then go on to explain each block and the functions of each knob. It is advisable to actually perform these settings and confirm the results by ear in order to fully understand all functions.

BASIC SETTING

1. Connect the synthesizer properly by referring to CONNECTIONS on previous page.
2. Set the switches and knobs as illustrated below with arrow marks.
 - Do not use the other knobs yet.
3. This completes the basic setting to produce sounds.
 - The knobs and switches have serial numbers from ① to ⑥2, and are explained under that number.

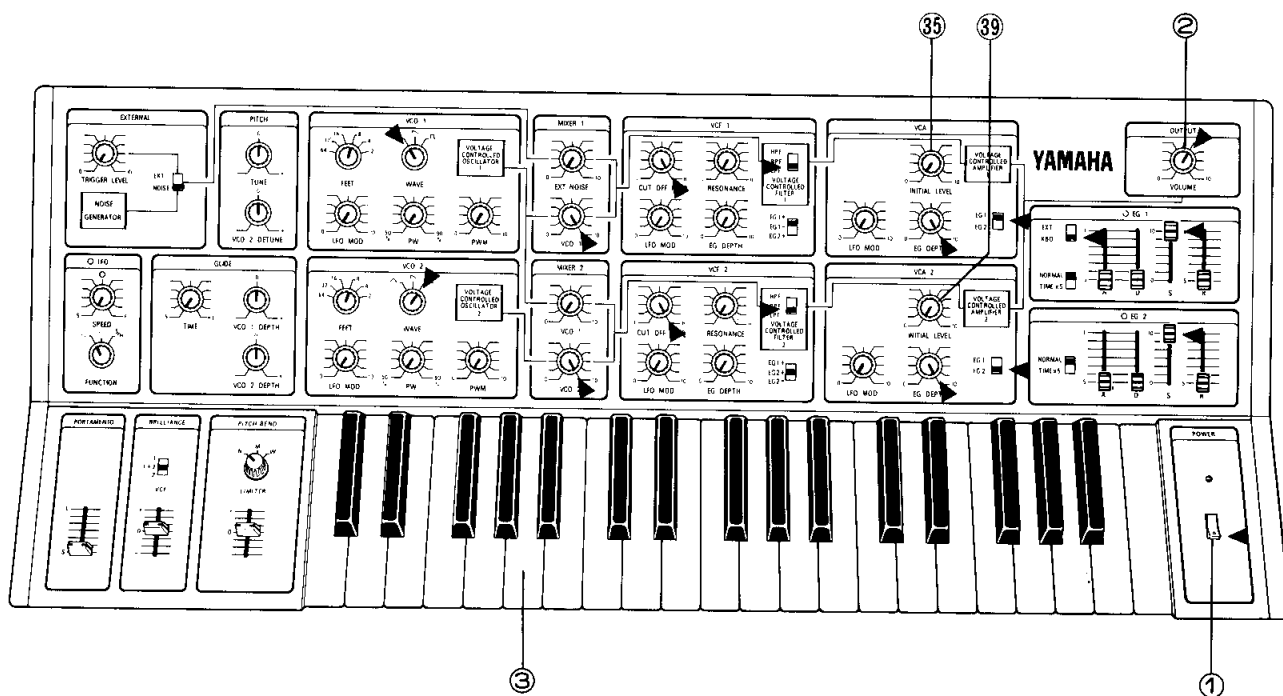

① POWER SWITCH

When pushed down, the synthesizer is switched on and the indicator illuminates.

② VOLUME

This is used to control the overall volume of the OUTPUT block.

- The volume control on the amplifier and that of the CS-15 determine the final volume.

③ KEYBOARD

The CS-15 covers 3 octaves with 37 keys.

- When two or more keys are depressed at the same time, priority will be given to the key of the higher pitch. The CS-15 is a monophonic synthesizer with higher-pitch priority.
- When keys are depressed in the basic setting, sounds are produced.
- If the INITIAL LEVEL knobs ③5 and ③9 in the VCA block are turned towards 10, sound can be produced even without keys being depressed. This is convenient for sound experimenting purposes. (For ③5 and ③9 please refer to page 12.)

FUNCTIONS PITCH/GLIDE

The *PITCH* block works on the *VCO*, controlling the pitch.

- TUNE is effective on both VCO 1 and VCO 2, and DETUNE on VCO 2 only.

④ TUNE

This knob adjusts the pitch. It controls the pitch of both VCO 1 and VCO 2. If it is turned towards "plus", the pitch will rise. If it is turned towards "minus", the pitch will decrease. It is used for tuning the CS-15 to other instruments.

- After tuning on the synthesizer, the pitch will fluctuate for some time until the thermal equilibrium of the electronic circuit is reached. Thus, tuning should be done appr. 15 minutes or more after the power switch was turned ON.

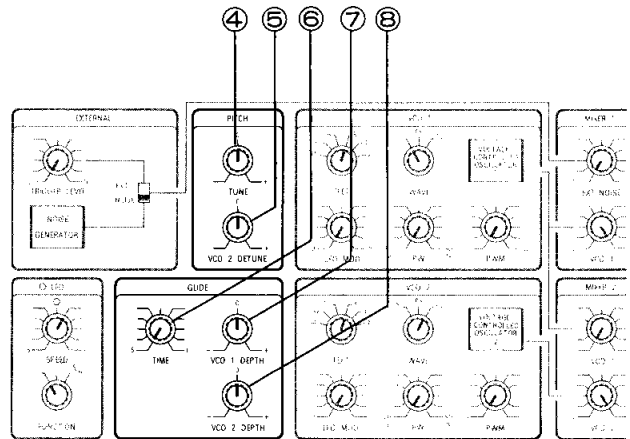

⑤ VCO 2 DETUNE

Used for adjusting the pitch of VCO 2 only.

- Also used to obtain chorus effects by changing the relative pitch of the two systems only slightly and to produce harmonic effects by changing it by a factor of 3, 5, etc. For further

details refer to page 20 where "USE OF TWO SYSTEMS" is described.

- Tuning must be made at the VCO 1 output. The pitch of VCO 2 is changed by DETUNE.

GLIDE BLOCK: This block varies the pitch in the attack period when sounds are being produced by depressing of the keys. In musical instruments, volume, tone, and pitch will be varied during the time from the start of the sound to its fading away. The temporal variations of volume and tone are generated by the EG block but variations of the pitch are generated by the GLIDE circuit.

⑥ TIME

This controls the time until the constant pitch corresponding to the intervals of the keys is reached. The further towards L the knob is turned, the longer is the time.

⑦ VCO 1 DEPTH

This knob adjusts the width of the pitch change in the attack period of VCO 1. With the knob set to 0 (click stop position), the pitch remains unchanged. The further towards "minus" it is turned, the lower the initial pitch becomes; the further towards "plus" the knob is turned, the higher the initial pitch becomes.

⑧ VCO 2 DEPTH

This knob adjusts the width of the pitch change in the attack period of VCO 2. The function is the same as that of VCO 1 DEPTH ⑦.

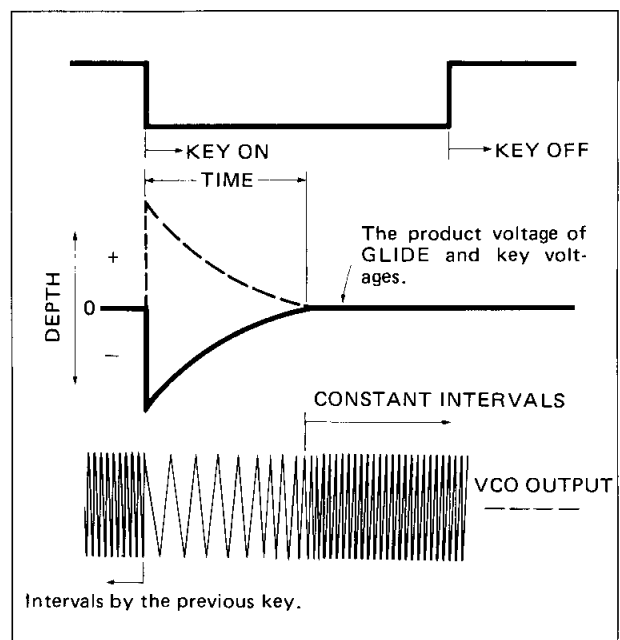

FUNCTIONS VCO

The VCO 1 and VCO 2 blocks consist of oscillators producing the sawtooth waves corresponding to the pitch of the keys (CONTROL VOLT) from the keyboard and of the Wave Shape Converter (WSC) to convert sawtooth waves into square or triangle waves.

⑨ ⑭ FEET

The keyboard covers three octaves with 37 keys. By making use of the FEET switches, the sound range to be covered can be shifted as shown in the diagram below.

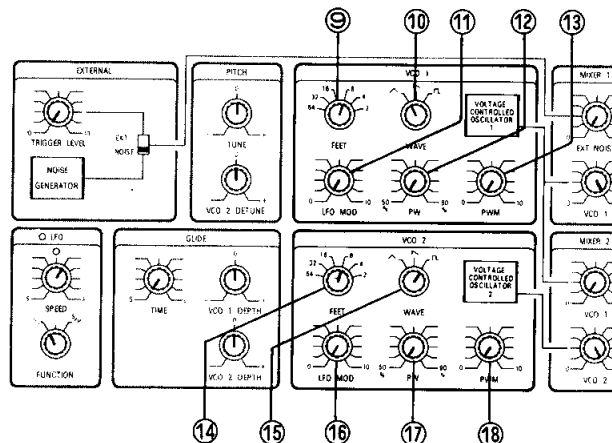
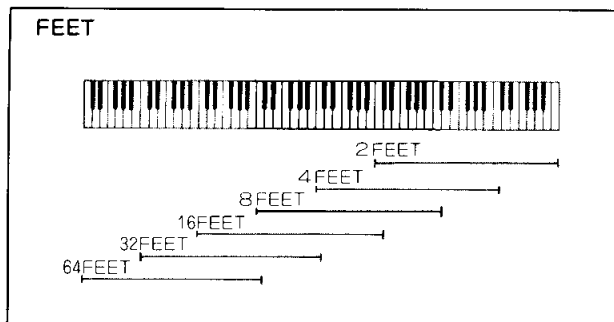

changes the harmonic structure of the square wave and allows it to be used as a sound source different from one produced by a symmetrical square wave.

⑩ ⑮ WAVE

These switches select the waveforms of the sound sources.

∧ : TRIANGLE WAVE

Though this waveform also has harmonics of the next odd number like the square wave, soft sound almost equivalent to sine wave (pure sound) can be obtained since it is rich in fundamentals.

∟ : SAWTOOTH WAVE

This waveform has harmonics of multiple integrals. Unlike triangle and square waves, it has richer harmonics, often being used as pseudo sound source for imitating instruments.

⌊ : SQUARE WAVE

This waveform has harmonics of the next odd number, being very like the spectrum of a musical instrument such as a clarinet, but it is possible to change the harmonic structure by the PW and PWM knobs and thus this waveform is suitable as a sound source to produce sounds peculiar to the synthesizer.

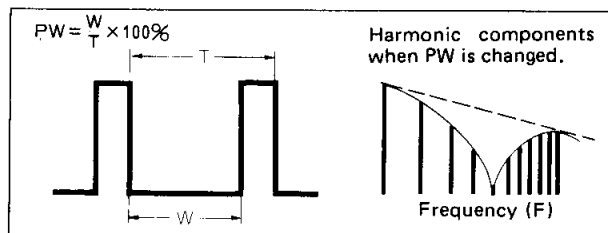

⑬ ⑱ PWM

This knob changes the pulse width of the square wave at cycles equivalent to the setting of the LFO's SPEED knob.

⑪ ⑲ LFO MOD

This block modulates the VCO's oscillating frequency by means of a LFO. If this knob is turned towards 10, the modulation will become deeper.

⑫ ⑳ PW

This knob changes the pulse width of the square wave (50% to 90%). Changing the pulse width

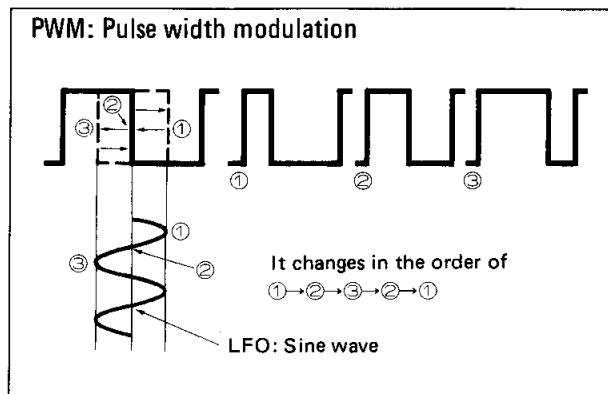

FUNCTIONS MIXER/EXTERNAL

The MIXER block regulates the input level to the VCF block. The sound sources to be selected by the MIXERS can be different for system I and system II.

MIXER 1 (Input of system I)

System I can use the VCO 1 output and noise or external signals as a sound source. VCO 1 can be adjusted in pitch by the TUNE knob alone, therefore it is suited to produce basic sound or to create effect sounds by noise.

19 EXT/NOISE

This knob adjusts the input level to the VCF 1 block when external signals or noise connected to the EXTERNAL IN terminal on the rear panel are used as a sound source.

Selection of external signals or noise can be made by the EXT/NOISE selector switch in the EXTERNAL block.

- The input level of the external signals is determined by this knob regardless of the TRIGGER LEVEL knob of the EXTERNAL block.

20 VCO 1

Adjusts input level to the VCF 1 block when VCO 1 output is used as a sound source of system I.

MIXER 2 (Input of system II)

This can choose VCO 1 and VCO 2 outputs as sound sources. The particularity of the VCO 2

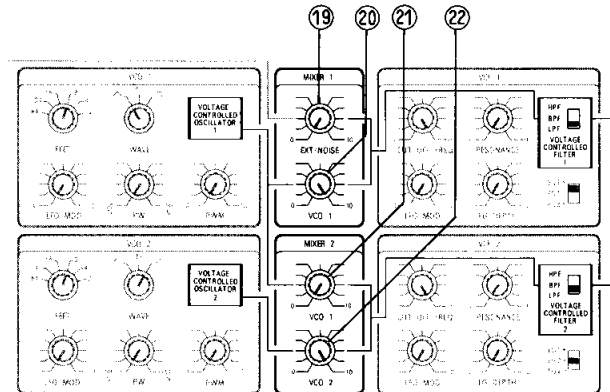

output is that it is possible to produce, with the help of the DETUNE knob (5), a pitch difference to VCO 1. Thus, system II is suited for DETUNE applications.

- For full use of the two systems synthesizer CS-15 see page 20.

21 VCO 1

Adjusts the input to the VCF 2 block when VCO 1 output is used as a sound source.

22 VCO 2

Adjusts the input to the VCF 2 block when VCO 2 output is used as a sound source.

The EXTERNAL block is an input controlling section which permits the use of external signals, such as from an electric guitar connected to the EXTERNAL terminal on the rear panel, as sound sources to be passed on to the VCF and VCA.

- For the EXTERNAL signals and TRIGGER LEVEL knob refer to page 15.

NOISE

If the EXT/NOISE switch is set to NOISE, noise can be used as the sound source with the EXT/NOISE knob of the MIXER block. The noise is white noise including all frequency components from low to high frequencies. It is well suited as sound source to imitate such natural sounds as wind, waves, and locomotion sounds, etc.

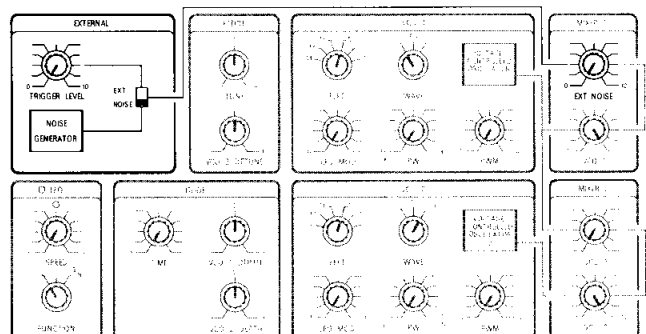

FUNCTIONS VCF

The VCF blocks change the harmonic structure of the sound sources and control the tone coloration via the cut-off frequency of the filter, influenced by the control voltages from the envelope generators, etc.

- When checking the functions of VCF or making tone adjustments, the control of the BRILLIANCE block should be set to the center.

23 29 HPF/BPF/LPF Filter selectors

These switches select the types of filter.

HPF : High-Pass Filter

Frequencies lying between the cut-off frequencies pass. The CUT-OFF FREQ knob is used to set the width of the band being passed. In the L position we get a narrow band width, as the FREQ knob is moved toward H the band of frequencies is widen.

BPF : Band-Pass Filter

Frequencies lying between the cut-off frequencies pass.

LPF : Low-Pass Filter

Frequencies lower than the cut-off frequency pass. This type of filter is generally used in synthesizers.

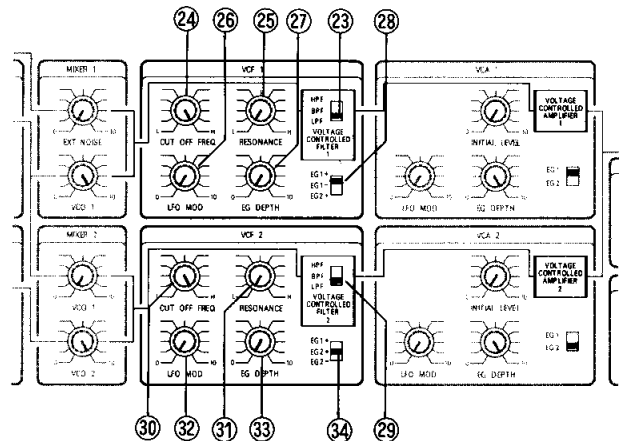

- The cut-off frequency can be also controlled by the control in the BRILLIANCE block.
- If the cut-off frequency is set so low that all the harmonics as well as the fundamental are cut, no sound is produced. This condition exists when the CUT OFF FREQ knob is turned fully to L with the filter selector set to LPF.

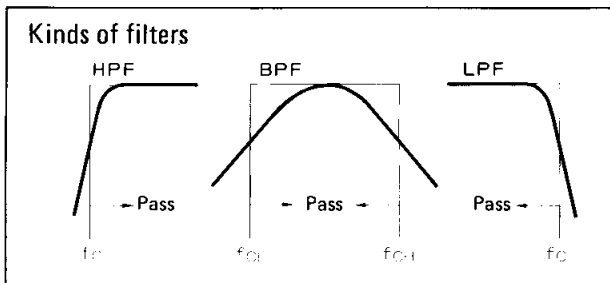

25 31 RESONANCE

If the RESONANCE knobs are turned towards H, the harmonics in the neighborhood of the cut-off frequency are emphasized to make tones more accentuated.

24 30 CUT OFF FREQ

This knob controls the boundary frequency between the range being passed by the filter and the range being cut, called cut-off frequency. The further towards H side it is turned, the higher the cut-off frequency becomes. This part is very important in producing basic tone qualities from a synthesizer.

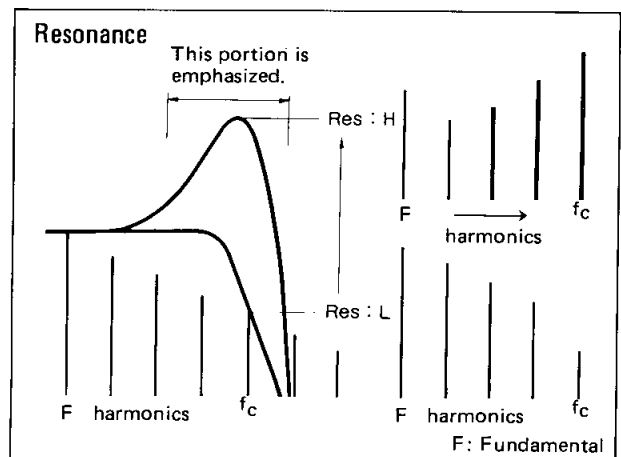
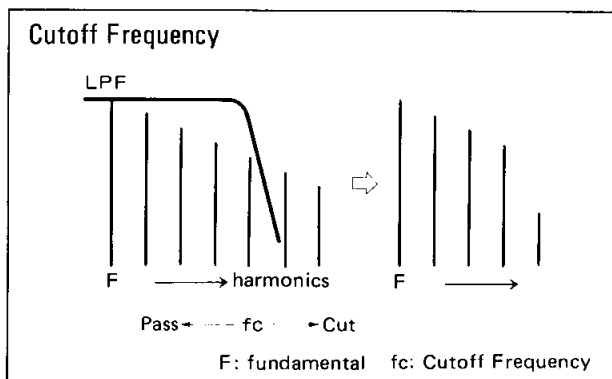

FUNCTIONS VCF/VCA

26 32 LFO MOD

The cut-off frequency can be modulated by the LFO. The further towards 10 the knob is turned, the deeper the modulation becomes.



27 33 EG DEPTH

Adjust the depth of the envelope set by the EG block to be applied to the VCF.

- If the CUT OFF FREQ knob is used to control the tone quality with EG DEPTH in 0 position, and the EG DEPTH is then deepened, sometimes sound will cease to be produced. This will happen when the cut-off frequency, as lowered by EG, becomes so low as to cut even the fundamentals of the sound sources.

28 34 EG

These switches select the envelope generators of EG 1 or EG 2.

The ordinary envelope wave  is produced in EG 1 + and EG 2 +, while in EG 1 - and EG 2 - the reversed envelope wave  is obtained.

The + direction of EG reacts to the direction in which the cut-off frequency becomes higher.

The VCA blocks are voltage controlled amplifiers which amplify the signals according to envelope curves to change the volume produced by VCF.

35 39 INITIAL LEVEL

Adjusts the level (initial level) of the output volume from the VCA when keys are not depressed. This is used when effect sounds are to be produced regardless of the keyboard or sounds are needed for checking purposes while making adjustments.

- The output volume from the VCA is combined from the levels set by the INITIAL LEVEL knob and the EG knob.

36 40 LFO MOD

Modulate the VCA at a cycle set by the LFO block and changes volume periodically. The further towards 10 the knobs are turned, the deeper is the modulation.

37 41 EG DEPTH

Adjust the depth of the envelope set by the EG block to be applied to the VCA.

38 42 EG

Select either EG 1 or EG 2.

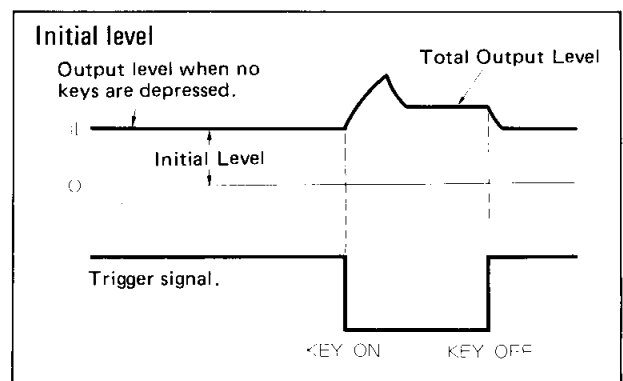
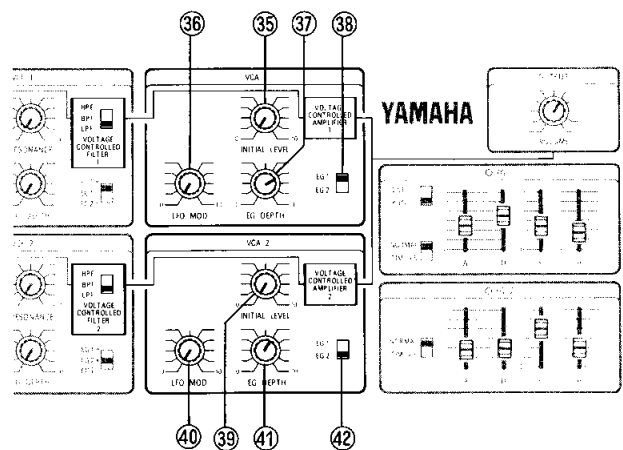

FUNCTIONS EG

The EG blocks create an envelope curve in the four modes of generation of sounds A (ATTACK), D (DECAY), S (SUSTAIN) and R (RELEASE) and submit the sound to temporal change. The EGs (envelope generator) function on the VCF and VCA blocks and produce the envelope curves to lend temporal change to the tone produced in the VCF blocks and the volume. EGs start in the VCA blocks. The EGs are controlled by trigger signals from the keyboard, corresponding to the KEY-ON, KEY-OFF timing, or by external signals.

43 EXT/KBD

This switch selects whether the envelopes of EG 1 are triggered by the ON/OFF of the keyboard or by external signals. For normal keyboard performance it is turned to the KBD position; to trigger the envelopes with external signals it is turned to the EXT position.

44 49 A (ATTACK TIME)

Adjust the time from the moment when keys are depressed until maximum change. It controls the attack characteristics at the beginning of sound production. Sliding the control towards L causes slower attack.

45 50 D (DECAY TIME)

Adjust the decay time from the maximum change until the stable condition set with the SUSTAIN LEVEL controls (46) (51) is reached. Sliding towards L causes slower decay.

46 51 S (SUSTAIN LEVEL)

Adjusts the stable sound level that will sustain until keys are released after changes by ATTACK and DECAY TIME have been completed. Sliding towards 10 causes the SUSTAIN LEVEL to become higher.

47 52 R (RELEASE TIME)

Adjust the time from the release of keys until the sound completely fades away. Sliding towards L causes the time to become longer.

48 53 NORMAL/TIME X 5

If the switch is set to the TIME X 5 position, the time set with A, D, and R controls will become approximately five times longer.

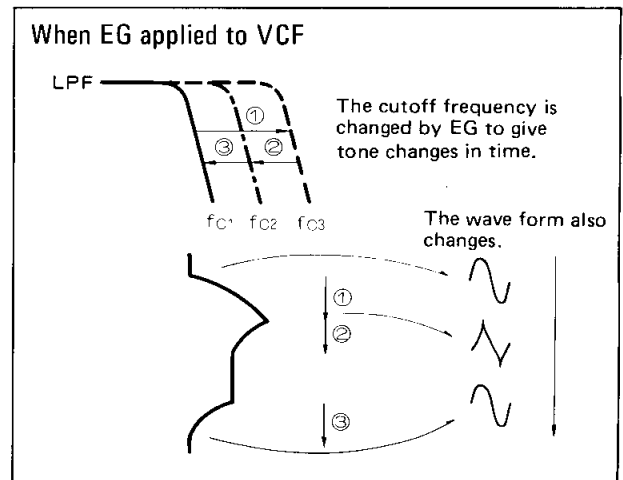
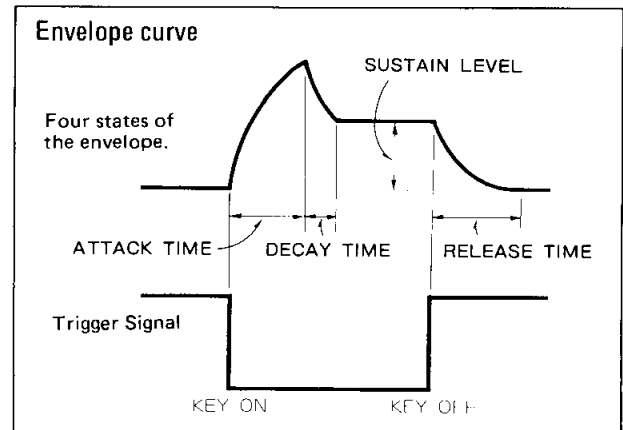
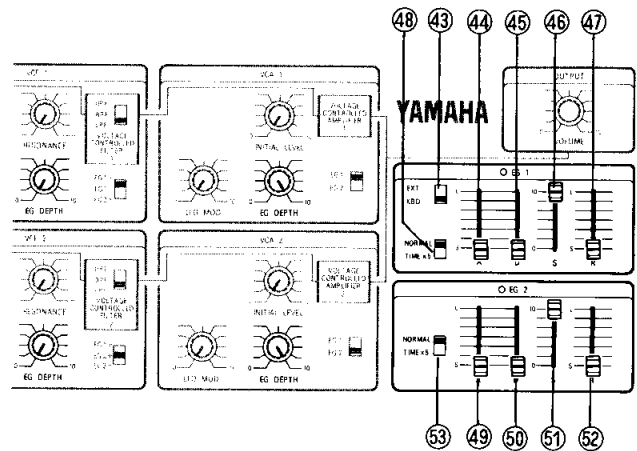

FUNCTIONS LFO/EFFECT

The LFO block modulates each of the VCO, VCF, and VCA blocks and is a low-frequency oscillating block to induce periodical variations in pitch, tone, and volume.

54 SPEED

This knob adjusts modulation speed. The more the knob is turned towards F, the faster the speed becomes. Adjustable range is 0.1 to 100 Hz. Change of speed permits different sound effects.

55 FUNCTION

This switch serves to select the waves modulating each block. The LFO effect depends greatly upon the LFO waveform. Confirm its effect by ear.

~ : Sine Wave

A gently changing effect is obtained. It can give a vibrato effect to the VCO, growl effect to the VCF, and tremolo effect to the VCA.

∩ : Sawtooth Wave

Intermittent sudden and slow changes.

S/H : Sample and Hold

Causes irregular changes. S/H samples an instant value of the irregularly changing

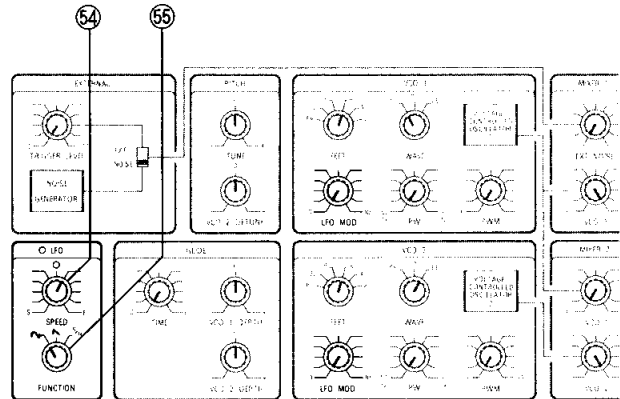

noise waves, and sustains that value until another sampling is made, thus producing irregularly changing modulation signals. The sampling period is determined by the SPEED knob.

The EFFECT block controls pitch and tone quality temporarily during performance and permits variations in performance.

56 PORTAMENTO

Portamento is an effect by which the sound of one key smoothly changes into the pitch of the next one depressed. This control adjusts its shifting speed. The further it is raised towards L, the longer the transition time becomes.

BRILLIANCE

An effect control to be used to change tonal quality, previously set by the VCF block on the panel, during playing.

57 VCF Selector Switch

Selects the VCF on which the BRILLIANCE effect is functioning.

If the switch is set to 1, it actuates VCF 1, if it is set to 1 + 2, it actuates both VCF 1 and 2; if the switch is set to 2, it actuates VCF 2.

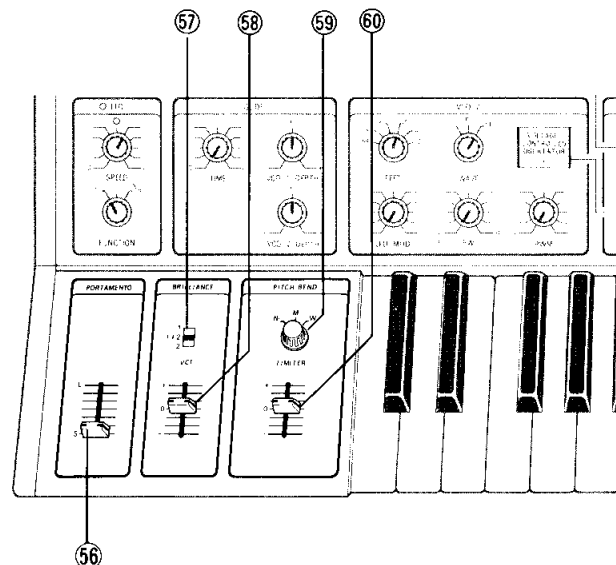

FUNCTIONS EFFECT/EXTERNAL

58 BRILLIANCE CONTROL

When the control is set to the center 0, the tone quality is that set by the panel; when set to + side, the cut-off frequency becomes higher, which will generate bright tones including higher harmonics, while set to - side, the cut-off frequency becomes lower, which will generate soft tones.

- Depending on the kinds of filters, the position set by the CUT OFF FREQ knob, and other factors, if the control is slid, no sound will be produced in some cases.

PITCH BEND

A manually operated control used to change the pitch during playing.

59 LIMITER

Determines the variable pitch range of the pitch bend control. Position of the LIMITER switch brings about the following:

- N (NARROW) ±200 Cent.
- M (MIDDLE) ±300 Cent.
- W (WIDE) ±1,200 Cent. (±1 Octave)

60 PITCH BEND LEVER

If the lever is set to + side, the pitch becomes high; if set to - side, it drops.

.....

The synthesizer effect can be applied to external signals by connecting external sources such as a microphone or electric guitar to the EXTERNAL IN terminals on the rear panel.

1 EXTERNAL IN

Terminal to input external signals.

2 0/-20 Input Sensitivity Selector Switch

Set this switch according to the external signal levels. In the case of low level inputs such as microphone the switch is set to -20 (dB) and in the case of electric guitar, electronic piano, and mixer outputs, to 0, respectively.

61 TRIGGER LEVEL

EG 1 can be triggered by external signals. (For EG 2 this is not possible.) The TRIGGER LEVEL knob is to be set so that TRIGGER ON/OFF signals can be generated at a proper level from external signals, with the trigger selector (43) of the EG 1 block set to EXT.

- When trigger signals are supplied by external signals, the position of the EXT/NOISE switch (56) and EXT/NOISE knob (19) of the MIXER 1 block are irrelevant.

62 EXT/NOISE

When external signals are used as the sound source, the switch is set to EXT. When noise is used as the sound source, it is set to NOISE.

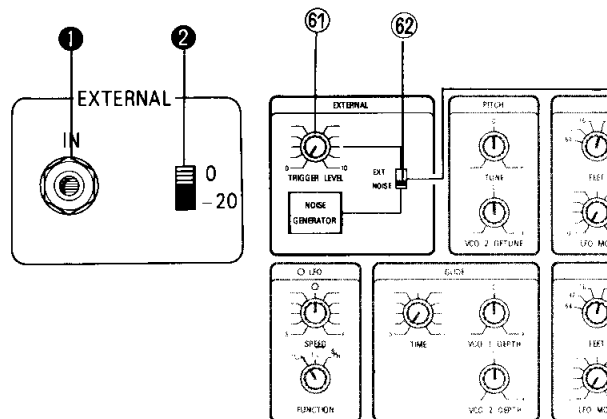

- The TRIGGER LEVEL knob (61) is irrelevant in the adjustment of the input levels of the external signals.
- External signals can be used as the sound source alone without any trigger function. (In this case, the EXT/KBD switch (43) is set to KBD.)

CONNECTING TWO SYNTHESIZERS

The CS-15 has terminals for input and output of CONTROL VOLT signals to control the voltage corresponding to the interval of the keyboard, TRIGGER to EG. It can also feed them to a different synthesizer having the same input/output terminals or receive them from another synthesizer. Thus, one keyboard can control many VCO → VCF → VCA.

- The terminals of the following models have equivalent function as the CONTROL VOLT of the CS-15. CS-10, CS-30 and CS-30L: KEY VOLT
CS-30: CONTROL VOLT of the SEQUENCER OUT port.

- CONTROL VOLT and TRIGGER can be fed in and out independently.
- For further details on main and sub controls when two or more synthesizers are connected, see the BLOCK DIAGRAM on page 22.

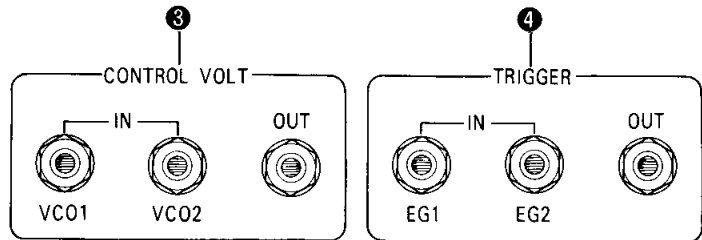

3 CONTROL VOLT

An input/output terminal for the CONTROL VOLT or KEY VOLT terminals of other synthesizers.
IN VCO 1/VCO 2

Terminals to feed the CONTROL VOLT or KEY VOLT of other synthesizers into VCO 1 or VCO 2.
OUT

A terminal to feed it to other synthesizers.

4 TRIGGER

Input/output terminals between TRIGGER terminals of other synthesizers.
IN EG 1/EG 2

Terminals to feed in TRIGGER signals controlling EG 1 or EG 2 from other synthesizers.
OUT

A terminal to feed TRIGGER signals to other synthesizers.

- Wrong connection of these controls can cause damage, so careful attention should be paid when making connections.

- The following is an example in which the CONTROL VOLT and the TRIGGER signals of the synthesizer 1 (CS-15) are transferred to the VCO 2 of the synthesizer 2 (CS-15). Thus the synthesizer 1 keyboard can control three systems consisting of two systems of the synthesizer 1 and one system (VCO 2) of the synthesizer 2 at the same time. The VCO 1 side of the synthesizer can be normally operated by the keyboard of the synthesizer 2. As a result, a multi-keyboard use is possible, in that the synthesizer 1 controls three systems and the synthesizer 2 one system.

SYNTHESIZER 1

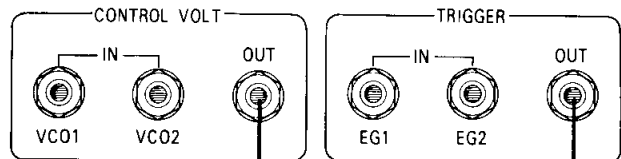

SYNTHESIZER 2

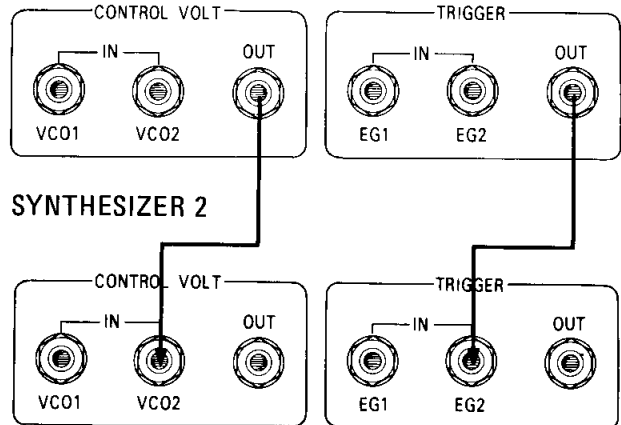
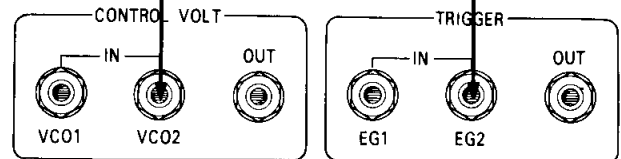

APPLICATIONS IMPORTANT POINTS

1. HOW TO SELECT WAVEFORMS

Waveforms have to be considered first of all when creating tones. The CS-15 provides three kinds of waves, \wedge (triangle), \sphericalangle (sawtooth), and \square (square), as well as noise. Let us explain the particular use of each.

The most fundamental is the \sphericalangle (sawtooth wave), which has a tonal quality (harmonic components)

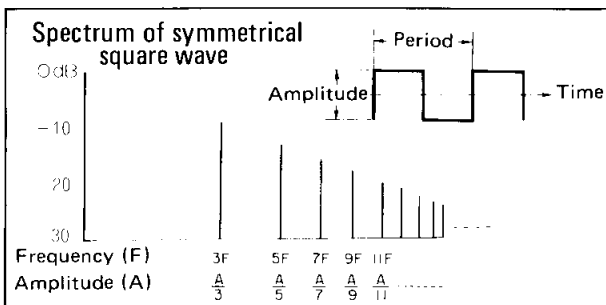
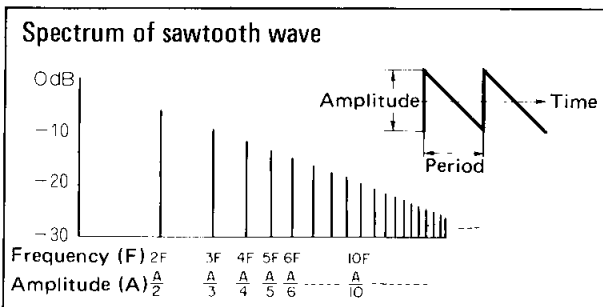
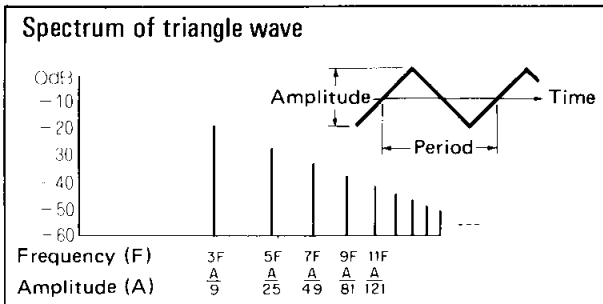
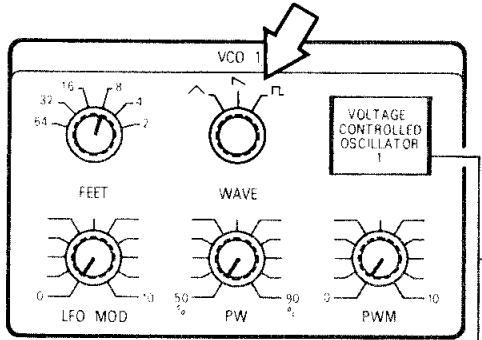

similar to those of trumpet and violin. As one can change tones with pulse width (PW), this wave has a variety of uses. For example, if PW is 50%, its tone resembles that of the clarinet. If PW is 60 to 70%, the tone resembles that of a saxophone. If PW is 80 to 90%, the tones resemble those of an oboe and bassoon. The pulse waves are suitable for creating the tones of reed instruments. Though the triangle wave has harmonic components similar to that of a 50% pulse wave, it sounds soft because of their low level.

2. HOW TO SELECT THE FILTER

The function of the filter is to cut the harmonics of the sound source waveforms to approximate them to the desired tones. The filter of CS-15 provides a selection of three modes, HPF (high-pass filter), BPF (band-pass filter), and LPF (low-pass filter).

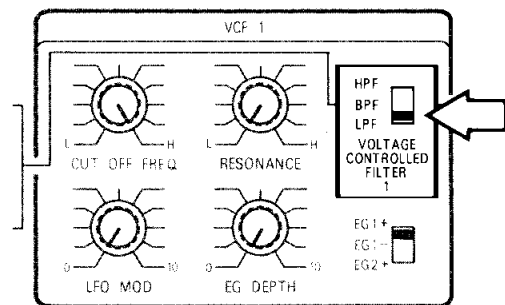

The HPF removes harmonics lower than the cut-off frequency but leaves high harmonics. The BPF removes high and low harmonics but leaves harmonics within the range of the cut-off frequencies. The LPF removes high harmonics but leaves harmonics lower than the cut-off frequency. When producing instrument sounds, the LPF is used in most cases. The reason for this is that the LPF can control high harmonics components while retaining the fundamentals. When lighter tones are desired or low components are to be cut, the BPF is used. The HPF is used when tones like those of cymbals are made or effect sounds are produced.

Let us explain general procedures of operations while taking the example of producing trumpet sounds.

APPLICATIONS HOW TO CREATE THE TRUMPET SOUND

■ VCO 1 Setting

Set waveform to \sphericalangle . FEET selecting range to 16'. Set LFO MOD knob fully to 0. Usually the LFO controls are used for finishing touches after the basic sounds have been made with VCF and VCA.

The positions of the PW and PWM switches do not matter. These are used only when \square is selected as waveform.

■ MIXER 1 Setting

Sends the signals selected in VCO 1 to VCF. Other knobs including the MIXER 2 must be all fully turned down.

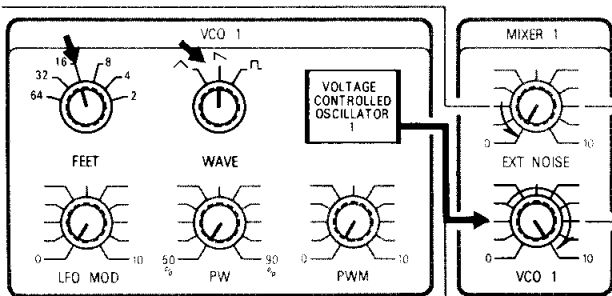

■ VCF 1 Setting

Set the filter mode to LPF. Set the CUT OFF FREQ knob fully to H. This is to feed the whole spectrum of the \sphericalangle waves including the highest harmonics to the VCA. With the RESONANCE and LFO knobs turned fully left, set the EG selector switch to EG 1+. EG DEPTH is set to 0.

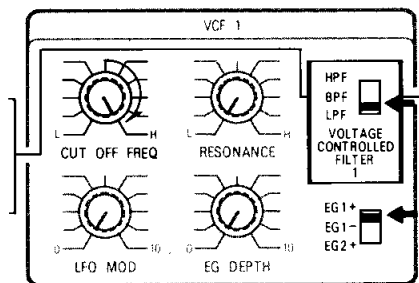

■ VCA 1 Setting

With EG selector switch set to EG 1, turn the EG DEPTH to fully right. Set INITIAL LEVEL, LFO MOD to 0. Thus, EG 1 alone determines changes in volume.

■ EG 1 Setting

With the EXT/KBD switch set to KBD, raise the SUSTAIN control. Set the NORMAL/TIME X 5 switch to NORMAL. This produces an envelope shaped \square . Set the output volume as required.

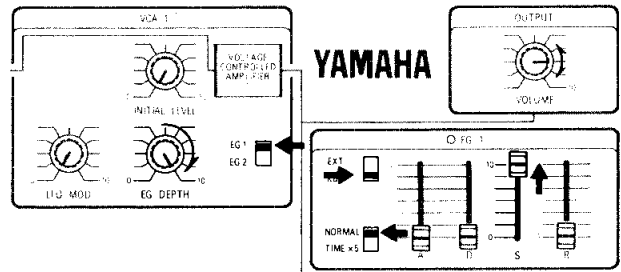

■ FIRST STEP – VCF

In this condition, a melody can be played on the keys. But to produce the tonal quality of the trumpet requires another step, operation of the CUT OFF FREQ knob. While playing the keyboard, turn the CUT OFF FREQ knob slowly to the left. This will give you a gradually lowering cut-off frequency, causing the harmonics at a high range to be cut off and tones to become softer. When the knob is at a position somewhat left from center, you will be able to obtain sound approximating that of a trumpet. This adjustment is to be continued until roughly satisfactory results are obtained.

Note: Is the BRILLIANCE control on the left of the keyboard set as shown below? Operate this control too. With the switch set to VCO 1, if the control is moved up and down, the tones become hard or soft like the effect of the CUT OFF FREQ knob.

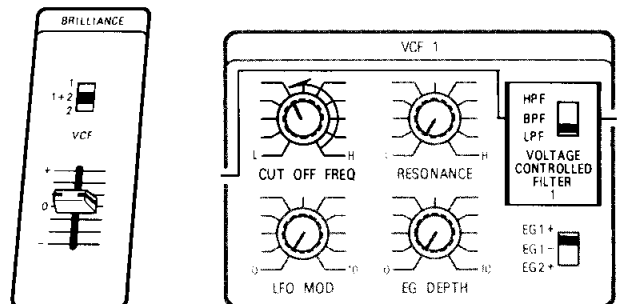

■ SECOND STEP – EG

The sound has been made to resemble that of the trumpet with help of the VCF, but it still has no expression. This is because the EG 1 so far was used only to raise the SUSTAIN LEVEL. It is necessary to study the EG 1 setting more in detail to come still closer to the characteristics of the trumpet. As the trumpet is not an electronic instrument, it does not produce a certain, constant volume and sound every time it is played. The characteristics of the instrument are displayed on the attack of the sound. Though this is only instantaneous, something like the sound of a musical instrument cannot be generated without its reproduction. The sound of the trumpet

depends upon the lip vibration of the player, so that the sound is small in volume and soft in tone at the outset. As soon as lip vibration starts, volume and tone reach a peak and settle then to a stable level.

EG and Filter

Let us consider the difference between peak and stable level. In the case of the trumpet, this difference presumably is not so big. So we decrease the SUSTAIN level only by that amount.

When the SUSTAIN level has been determined, begin applying EG on the VCE. Raise the EG DEPTH knob of VCF 1. When the keys are depressed, clicks are heard at the beginning and the tones change while the keys are kept depressed. Now readjust the CUT OFF FREQ knob under the assumption that the continued depressing of the keys represents the trumpet being continuously blown.

Set DECAY TIME to a proper value with D. (As there is only a slight difference between the peak level and the SUSTAIN level, only a small effect is necessary.)

Determine the ATTACK TIME with A while depressing the keys. This is very delicate and must be done with care. A slight sliding will be sufficient.

Now, as the EG DEPTH has been raised to 10, the tone change at the envelope peak seems to be too big. Therefore turn the EG DEPTH down to about the center position. Thus you will find that the tone change in the moment of attack approximates that of the trumpet. But this results in a change in tone at the SUSTAIN level. Adjust this again with the CUT OFF FREQ knob. This means that the depth of EG being applied to VCA and rate of the depth applied to VCF have been controlled by the EG DEPTH of the VCF.

Raise the RELEASE TIME only slightly so that the sounds do not fade away suddenly at the end.

This completes the trumpet sound creation. If slight RESONANCE is added, it makes the tones clearer. Has the final setting been made as illustrated below?

Try to create the sounds you desire little by little by repeating operations such as described above many times in various ways. Then try to produce sounds other than those of the trumpet. If you continue to generate various sounds, you will come to understand the functions of the synthesizer.

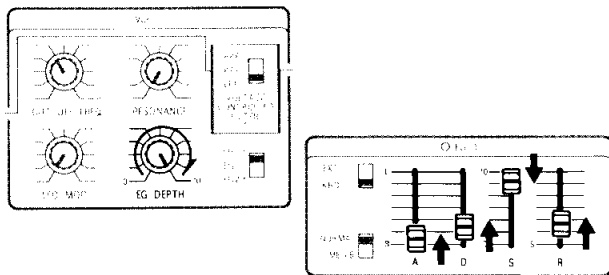

Final Setting

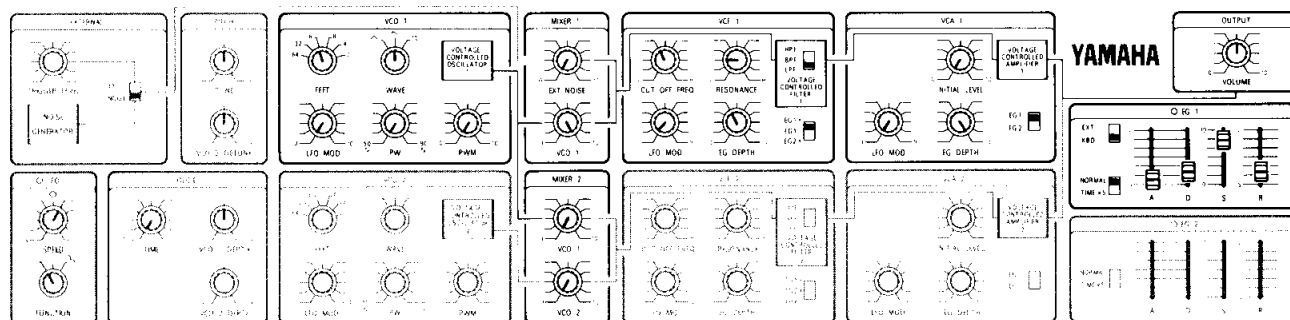

Memo.

APPLICATIONS USE OF TWO SYSTEMS

1. Using them with the same tone quality

- Pitch (FEET) set at same position for unison effect. Though slightly electrical, it is possible to produce a rich sound.
- Even if the pitch setting is the same, aim at a beat effect by changing the pitch of VCO 1 and VCO 2 slightly.
- Produce unique sounds with the FEET of VCO 2 set to 1 to 2 octaves up or down of VCO 1.
- Produce sounds that are special to the synthesizer by making VCO 2 perfect fifth interval of VCO 1 by means of DETUNE of VCO 2.

2. Using them with different tone quality

- It is possible to change the tone quality instantaneously by setting two kinds of tones and employing the MIXER part during performance.
- Effects that could not be produced with one VCF and EG system are possible by the double layout.

■ Performing FEET changeover with both systems set to the same tone quality.

Set VCO 2 and EG 2 to the tone of the trumpet by referring to the previous page. Balance VCO 1 and VCO 2 for unison with the use of VCO 2's DETUNE knob. Complete unison can be obtained when there is no beating between the two VCO's after the knob is adjusted. Though the sounds produced may be slightly electrical as compared with those in only one system, a richer sound can be obtained.

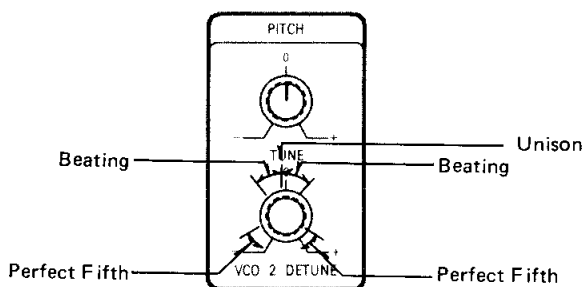

Next, slide the pitch of VCO 2 with DETUNE. Beating will arise between the two VCO's, which shows you that the sound source stems from two systems. This is useful in obtaining a concert effect and producing accordion sounds.

Return the DETUNE to unison and produce various sounds with FEET changeover. Return VCO 1 FEET to 8' and VCO 2 to 4' to try synchronizing VCO 1 and VCO 2 with VCO 2 in the one octave up position.

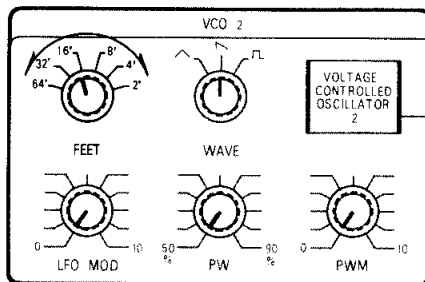

With the settings above you will notice that the sound clarity is enhanced. If the sound of 2 octaves higher is added, an effect just like supporting the melody with a piccolo is obtained. Let us now set VCO 2 to a lower octave. Set FEET to 32'. This produces strong tones. Then set it to 64'. You can achieve heavy bass sounds that even an electric bass would be hard put to surpass.

■ Using two systems set to different tone qualities

It is difficult to change the tone of the synthesizer during performances. When two systems are in use like CS-15, this makes it very convenient to change the tones by operating the MIXER with different tones having been set previously (for example, trumpet in 1 and flute in 2) set. To use the trumpet tones turn the VCO 1 knob to right. To use the flute alone turn it to left and turn VCO 2 to right. It is also possible to use both of them by balancing the tones with VCO 1 and VCO 2.

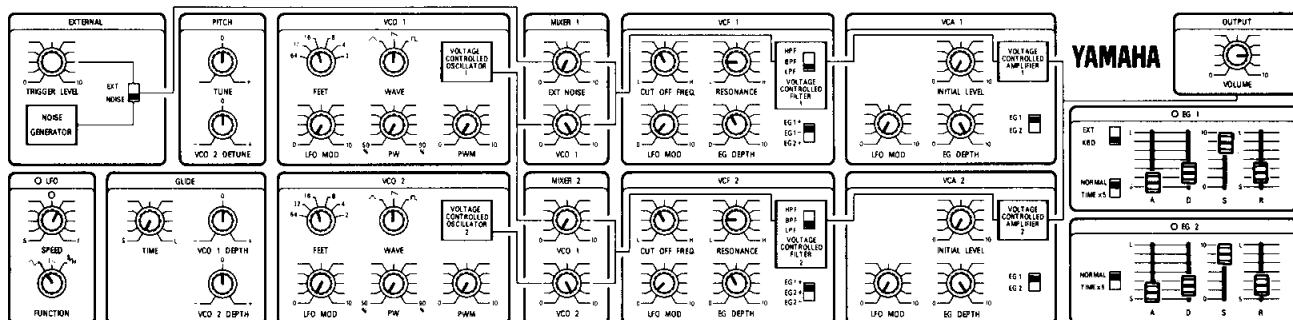

APPLICATIONS USE OF EFFECT CONTROLS

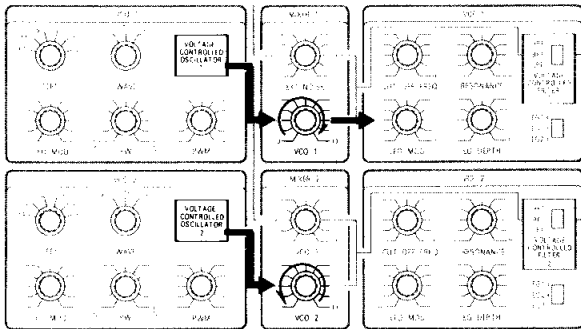

EFFECT CONTROLS

The CS-15 is equipped with superior possibilities to produce special effects, such as the BRILLIANCE control and the 3-position PITCH BEND, etc. In the following we will explain their use.

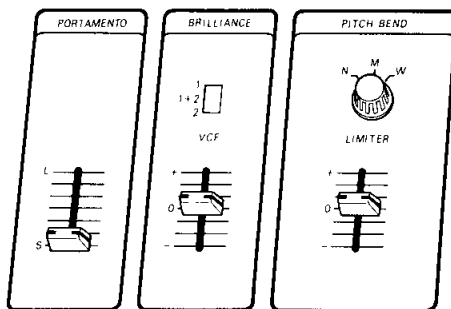

How to Use PITCH BEND

Even in the preset position, there is an effect of changing pitch with other controls. For example, in sound effects like the choking of a guitar or the blues harp, which lower the pitch. As the PITCH BEND of CS-15 divides the variable range into three steps with the LIMITER switch, selects the position suited to your purpose. N (NARROW) allows for a pitch change of one major tone up or down.

Score 1

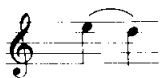

Score 2



For example, when you want to change a note from "E" to "D" using legato as shown in Score 1, depress the "D" note with the PITCH BEND set fully to +. The sound "E" will actually be heard. To lower the note to re, you do not need to hit another key with your right hand but only to return this control to the center. Thus you can obtain a smooth bend

effect without break up in the sounds. As the pitch is variable by Minor thirds up or down at the M (medium) position, a bend effect as indicated in Score 2 is obtainable. W (WIDE) allows for change by 1 octave up or down. Select any desired position.

How to Use the BRILLIANCE Slide Control

The CS-15 is equipped with a BRILLIANCE slide control so that the tone quality can be controlled easily without changing the CUT OFF FREQ knob of the VCF during performances. The VCF selector switch permits applying the control to VCF 1 or VCF 2 or both of them together. When much resonance has been put on, this control functions as a manual Wah Wah. Usually it is set to the center "O".

BLOCK DIAGRAM

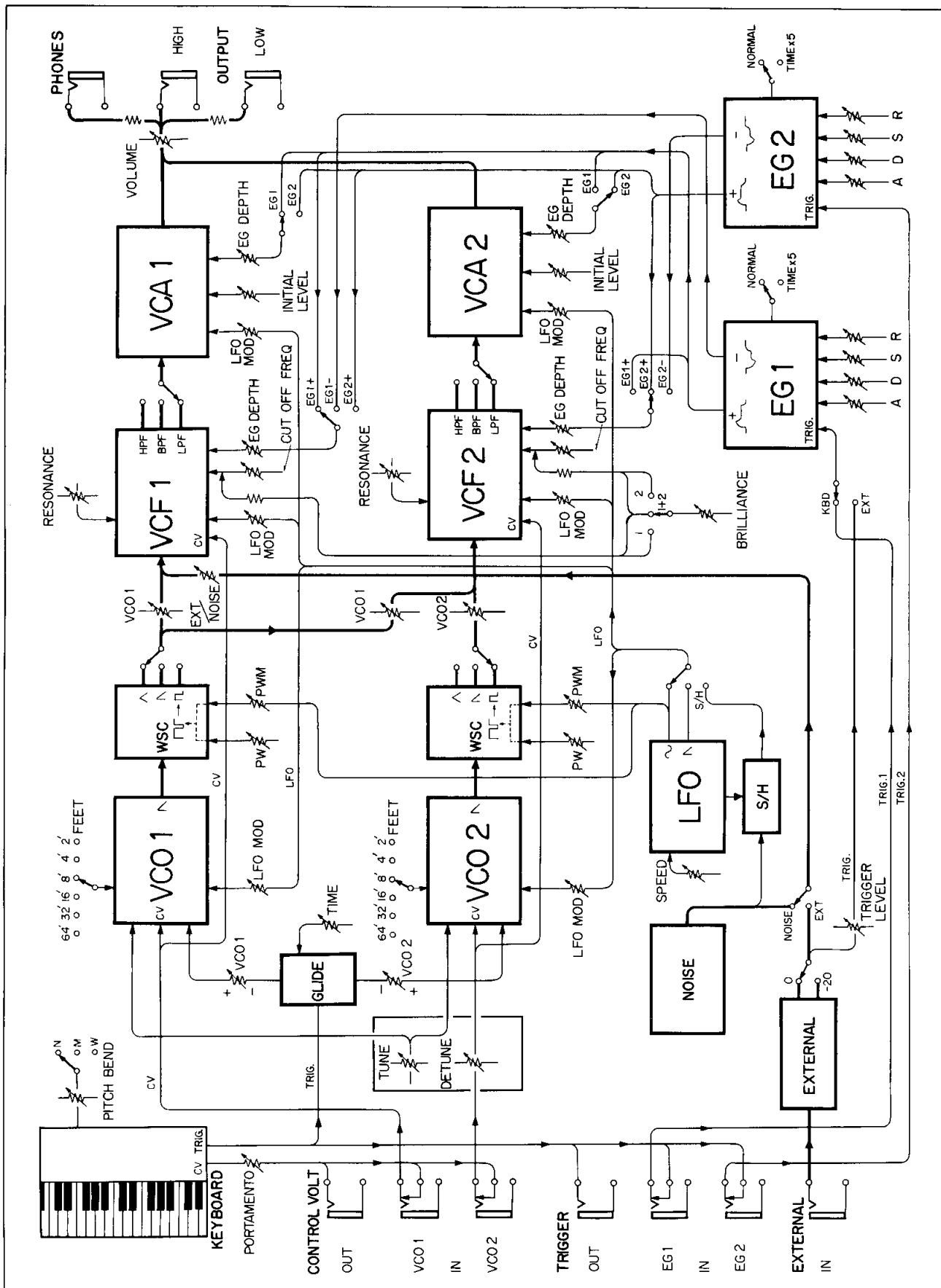

SOUND MEMO.

YAMAHA

DETAIL

DATE: / /

YAMAHA

DATE: / /

SPECIFICATIONS

KEYBOARD . . . 37 keys, 3 octaves

CONTROLS

EXTERNAL . TRIGGER LEVEL Control
EXT/NOISE Switch

LFO SPEED Control: 0.1 to 100 Hz
Waveform Selector: \sim / ∇ / S/H

PITCH TUNE Control: -75 to +75 cents
VCO 2 DETUNE Control:
-750 to +850 cents

GLIDE TIME Control: Max. 15 sec.
VCO 1 DEPTH: -750 to +550 cents
VCO 2 DEPTH: -750 to +550 cents

VCO 1 FEET Switch: 64', 32', 16', 8', 4', 2'
WAVE Selector: \wedge / ∇ / \square
LFO MOD Control:
-1,000 to +700 cents
PW Control: 50 to 90%
PWM Control: 35 to 80%

VCO 2 FEET Switch: 64', 32', 16', 8', 4', 2'
WAVE Selector: \wedge / ∇ / \square
LFO MOD Control:
-1,000 to +700 cents
PW Control: 50 to 90%
PWM Control: 35 to 80%

MIXER 1 EXT/NOISE Control
VCO 1 Control

MIXER 2 VCO 1 Control
VCO 2 Control

VCF 1 CUT OFF FREQ Control
RESONANCE Control: Q=0.5 to 10
LFO MOD Control: \pm 3 octaves
EG DEPTH Control: Max. 10 octaves
Filter Selector: HPF/BPF/LPF
HPF 12 dB/oct.
BPF 6 dB/oct.
LPF 12 dB/oct.
EG Selector: EG 1+/EG 1-/EG 2+

VCF 2 CUT OFF FREQ Control
RESONANCE Control: Q=0.5 to 10
LFO MOD Control
EG DEPTH Control: Max. 10 octaves
Filter Selector: HPF/BPF/LPF
HPF 12 dB/oct.
BPF 6 dB/oct.
LPF 12 dB/oct.
EG Selector: EG 1+/EG 2+/EG 2-

VCA 1 LFO MOD: AM modulation,
max. 90%
INITIAL LEVEL Control
EG DEPTH Control
EG Selector: EG 1/EG 2

VCA 2 LFO MOD: AM modulation,
max. 90%
INITIAL LEVEL Control
EG DEPTH Control
EG Selector: EG 1/EG 2

EG 1 Trigger Selector: EXT/KBD
Time Switch: NORMAL/TIME x 5
ATTACK TIME: 0.0025 to 2.5 sec.
DECAY TIME: 0.005 to 6 sec.
SUSTAIN LEVEL: 0 to 10 V
RELEASE TIME: 0.005 to 6 sec.

EG 2 Time switch: NORMAL/TIME x 5
ATTACK TIME: 0.0025 to 2.5 sec.
DECAY TIME: 0.005 to 6 sec.
SUSTAIN LEVEL: 1 to 10 V
RELEASE TIME: 0.005 to 6 sec.

OUTPUT . . . VOLUME control

PORTAMENTO

. Max. 3.5 sec.

BRILLIANCE

. VCF Selector: 1/1+2/2
Control Lever: - to 0 to +

PITCH BEND

. Variable Range: N/M/W
N (Narrow) \pm 200 cents
M (Middle) \pm 300 cents
W (Wide) \pm 1,200 cents
Control Lever: - to 0 to +

REAR PANEL

EXTERNAL IN

. Input Sensitivity: 0/-20 dB

TRIGGER . . . EG 1 IN, EG 2 IN

(OFF +15 to +3V) (ON 0 to -10V)
OUT (OFF +3 V) (ON -7 V)

CONTROL VOLT

. VCO 1 IN, VCO IN (+125 mV to +4V)
OUT (+125 mV to 4V)

OUTPUT . . . HIGH Output level (2dBm)

LOW Output level (-18dBm)

FRONT PANEL .PHONES Jack

OTHERS

POWER SOURCE USA and Canadian models
120 V 60 Hz
General models
110, 130, 220 or 240
V selectable,
50/60 Hz

POWER CONSUMPTION .15 watts

DIMENSIONS 754 x 174 x 332.5 mm
(W x H x D) (29-5/8 x 6-7/8 x 13-1/8")

WEIGHT 10 kg. (22 lbs.)

FINISH Semi-gloss black

Specifications subject to change without notice.

TROUBLESHOOTING

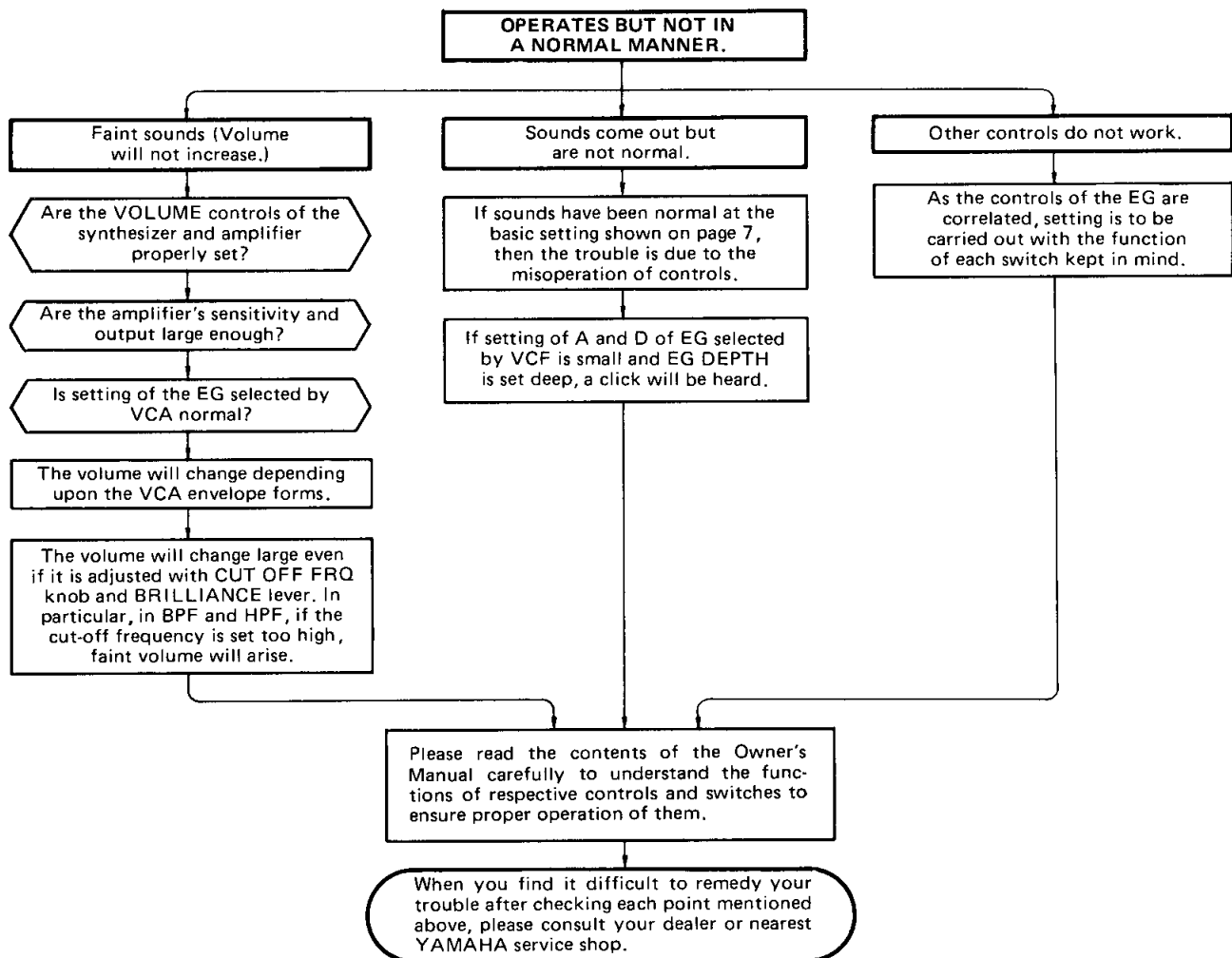
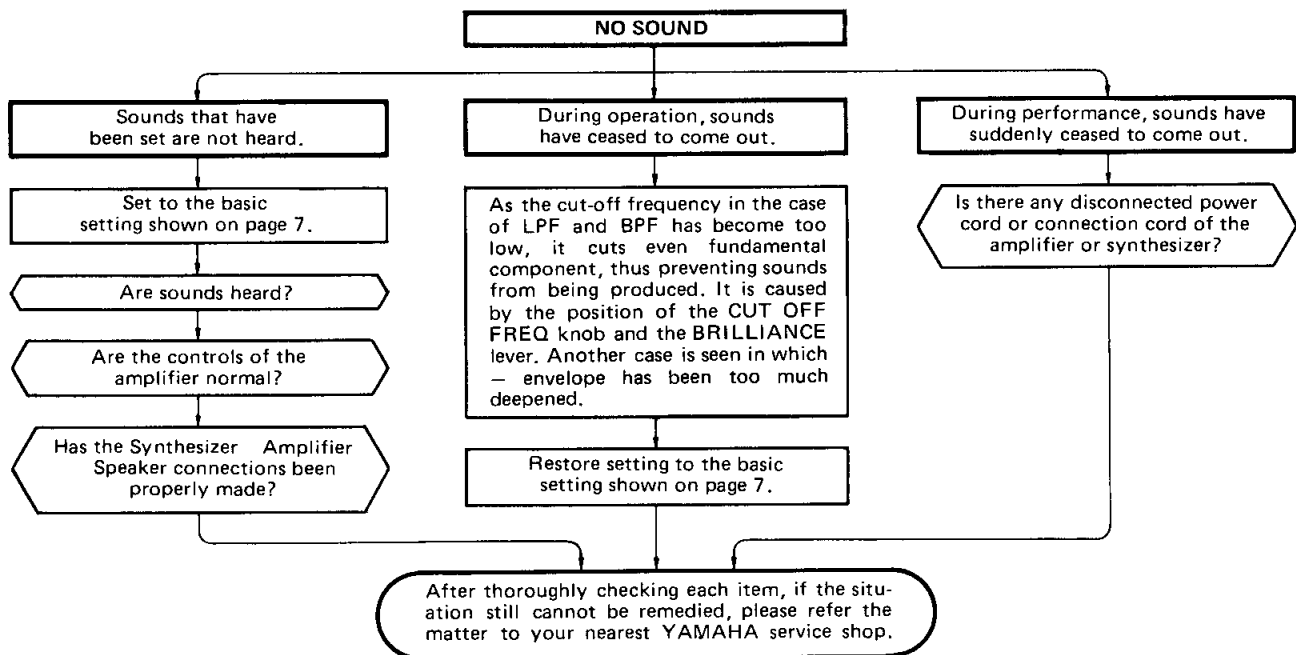

SINCE 1887  **YAMAHA**
NIPPON GAKKI CO., LTD. HAMAMATSU, JAPAN