

YAMAHA

**GUITAR AMPLIFIER
AMPLIFICATEUR DE GUITARE**

VR3000

**GUITAR AMPLIFIER
AMPLIFICATEUR DE GUITARE**

VR5000

**OPERATION MANUAL
MODE D'EMPLOI**

● INTRODUCTION

Congratulations!

You are now the proud owner of a Yamaha VR3000/VR5000 Stereo Guitar Amplifier. Your VR3000/VR5000 represents an exciting new concept in guitar amplifier design which provides vastly extended performance and creative potential in all areas. In addition to extraordinary flexibility and superior sound, it offers a broad range of control features and outstanding reliability.

In order to obtain maximum performance from your VR3000/VR5000, we urge you to read this operation manual thoroughly, and keep it in a safe place for later reference.

● MAIN FEATURES

★ 2-channel Configuration

From the input jacks to the reverb system, the VR3000 and VR5000 feature a 2-channel circuit configuration which allows the "A" and "B" channels to be set up to produce different sounds. You can instantly switch back and forth between the "A" and "B" channels as you play, changing sounds to optimally match your music.

Both the "A" and "B" channels offers exactly the same control complement.

★ Broad Sound Creation Capability

With a gain control which incorporates a pull-boost function, a volume control with pull-fat function and a 3-band tone control system with a pull-bright switch, these fine guitar amps offers tremendous potential for broad-yet-precise sound shaping.

★ Parametric Equalizers

Both channels feature versatile parametric equalizers that let you precisely pinpoint and boost or cut specific frequencies for uncompromising response control accuracy. The VR5000 offers extra control with twin parametric equalizers.

★ Reverb & Stereo Chorus

A top-quality reverb effect is built-into the VR3000 and VR5000, offering fully variable, warm reverb sound.

★ Newly-developed Large-diameter Speakers

These speakers were developed specially for the VR3000 and VR5000, featuring aluminum center-caps and large-diameter cones they deliver powerful, clean sound from the heaviest lows to the most sparkling highs.

★ Dual Effect Loops

The VR3000 and VR5000 have an external effect loop for compatibility with a wide range of external signal processing equipment. The signal from the external signal processor is returned to the amplifier prior to the reverb circuit.

★ Line Output & Headphone Jack

The line output jack allows direct connection to a mixing console or external power amplifier/speaker system, and a built-in headphone jack offers convenient headphone monitoring capability.

★ Footswitch Jack

An optional VFC-2 Footswitch connected to this jack can be used to switch between the "A" and "B" channels and switch the reverb effect ON or OFF.

● CONTENTS

Precautions	2
Control Panel	3
Rear Panel	5
System Example	6
Control Setting Examples	7
Specifications	9
Block Diagram	10

● PRECAUTIONS

- ◆ Avoid setting up your amplifier in the following locations to prevent possible damage:
 - In direct sunlight or next to heating equipment.
 - Extremely cold locations.
 - Locations exposed to high humidity or excessive dust.
 - Locations subject to strong shocks or vibration.
- ◆ In order to prevent damage to the speakers when plugging in connecting cables or turning the power ON/OFF, be sure to set the volume controls to their minimum settings.
- ◆ Make sure your amplifier is rated for the AC mains voltage in your area. Voltage ratings are given to the left of the rear panel. (General model only)
- ◆ If the fuse needs replacement, replace only with a fuse of the same type and power rating.
- ◆ The rear panel AC power outlet can provide a maximum of 250 watts of power. The total power rating of equipment connected to this outlet must be less than 250 watts. (For U.S. & Canadian models)
- ◆ Your Yamaha guitar amplifier is a precision musical instrument. Handle it with care and avoid dropping or bumping it.
- ◆ For safety, always remove the power plug from the AC wall outlet if there is any danger of lightning striking in your area.
- ◆ Keep the amplifier away from neon signs or fluorescent lighting to prevent noise pickup.
- ◆ To prevent damage and possibly electrical shock, never open the case and tamper with the internal circuitry.

● CONTROL PANEL

• VR3000

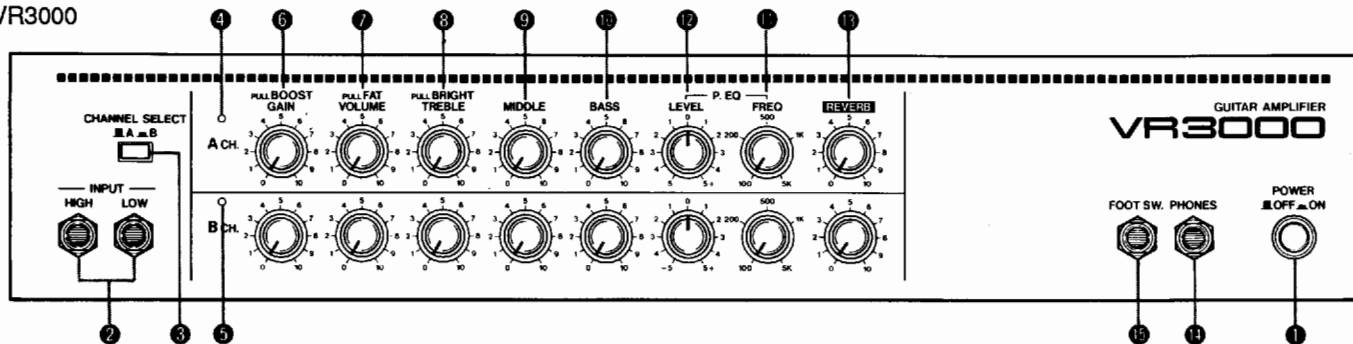

• VR5000

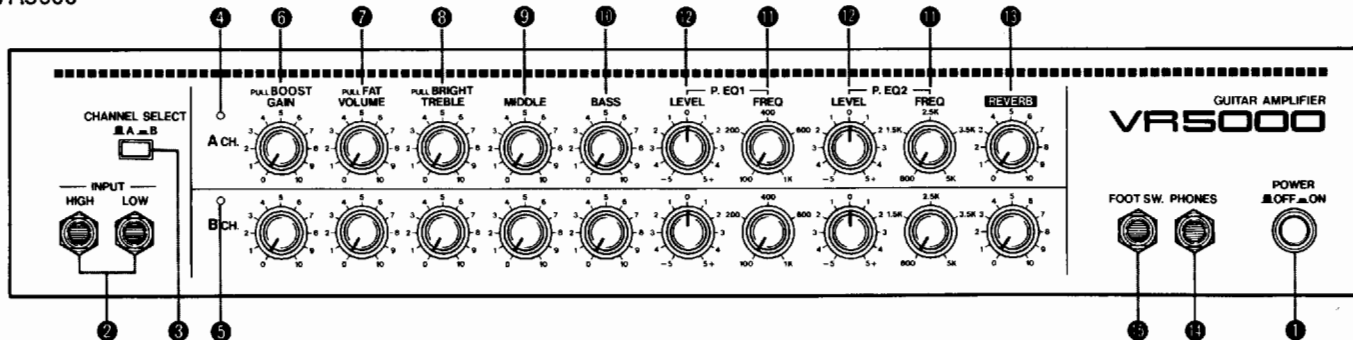

❶ POWER Switch





Press once to turn power ON, a second time to turn power OFF.

❷ INPUT Jacks

Standard electric guitars should normally be connected to the HIGH INPUT jack. The HIGH input has high sensitivity and high impedance, and produces a bright sound to which distortion can easily be applied.

The LOW INPUT jack is a low-sensitivity, low-impedance input that, in comparison with the HIGH input, produces a softer tone with less distortion. Guitars, keyboards or other sources with high-level output should be connected to the LOW INPUT jack.

❸ CHANNEL SELECT Switch

When the CHANNEL SELECT switch is in the  position, channel A is selected and only channel A will function. When the CHANNEL SELECT switch is in the  position, channel B is selected and only channel B will function. The A CHANNEL indicator  or B CHANNEL indicator  will light according to the selected channel.

* An optional footswitch connected to the FOOT SW jack  can also be used to switch between channel A and channel B. The front-panel CHANNEL SELECT switch becomes inoperative when the footswitch is used.

❹ A CHANNEL Indicator

❺ B CHANNEL Indicator

These indicators show which if the two amplifier channels is currently operating. The A CHANNEL indicator lights when the A channel is active, and the B CHANNEL indicator lights when the B channel is active.

❻ GAIN Control (with PULL BOOST Switch)

The GAIN control is used to adjust the amount of distortion applied to the sound of the corresponding channel. As the GAIN control is rotated clockwise toward the "10" end of the scale, the gain increases causing an increase in volume and distortion. Pulling the GAIN switch out towards you activates the BOOST function, applying even greater distortion to the sound.

7 VOLUME Control (with PULL FAT Switch)

This control sets the overall volume level of the corresponding channel. Pulling the VOLUME control out towards you activates the FAT function, boosting the midrange frequencies for a full, "fat" sound. The overall volume and distortion level achieved depends on the settings of both the GAIN control ⑥ and VOLUME control. Generally, it is best to use the GAIN control first to set the desired degree of distortion, then use the VOLUME control to set the desired volume level.

* If either the GAIN or VOLUME control is set to "0," no sound will be output.

8 TREBLE Control (with PULL BRIGHT Switch)

Adjusts the level of the high-frequency range. If you pull the TREBLE control out towards you the BRIGHT function is activated, further emphasizing the high frequencies for a sharp, brilliant sound.

9 MIDDLE Control

Adjusts the level of the midrange frequencies.

10 BASS Control

Adjusts the level of the low frequencies.

* If the TREBLE, MIDDLE and BASS controls are set to their center "5" positions, a fairly flat, "normal" sound is produced. If the TREBLE, MIDDLE and BASS controls are all set to their minimum "0" positions, no sound will be output.

11 P. EQ FREQ Control

The P. EQ FREQ control sets the center frequency of a range of frequencies to be boosted or cut using the P. EQ LEVEL control ⑫.

The VR3000 P. EQ FREQ control covers a frequency range from 100 Hz to 5 kHz.

The VR5000 has twin parametric equalizers which cover different frequency ranges, permitting two-point equalization. The P. EQ 1 FREQ control adjusts the EQ center frequency from 100 Hz to 1 kHz, and the P. EQ 2 FREQ control adjusts from 800 Hz to 5 kHz.

12 P. EQ LEVEL Control

The P. EQ LEVEL control permits applying a maximum of 15 dB boost or cut at the center frequency set using the corresponding P. EQ FREQ control ⑪. If no equalization is required, set the LEVEL control to its center "0" position.

13 REVERB Control

This control adjusts the amount of reverb effect applied to the corresponding channel. If no reverb is required, set the REVERB control to its minimum "0" position.

* The reverb effect can be switched ON and OFF using the optional VFC-2 footswitch.

14 PHONES Jack

The PHONES jack accepts any standard pair of headphones with an impedance rating between about 8 and 150 ohms. The headphones receive the same signal that appears at the rear-panel LINE OUT jack. Sound is output from the main speaker even if a pair of headphones is plugged into the PHONES jack. If you require headphone sound only, temporarily remove the plug connected to the rear-panel SPEAKER OUT jack.

15 FOOT SW. Jack

Accepts the optional VFC-2 Footswitch. When the VFC-2 is plugged into this jack, it can be used to switch between the A and B channels, and turn the reverb effect ON and OFF.

* Use ONLY the Yamaha VFC-2 Footswitch with this jack. Other footswitches can damage your amplifier.

● REAR PANEL

U.S. & Canadian models

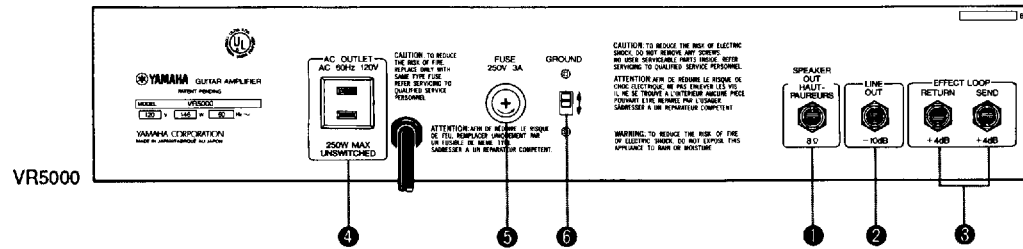

General model

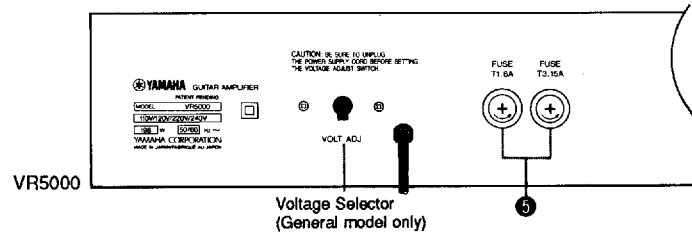

① SPEAKER OUT Jack

Normally, the amplifier's internal speaker is connected to this jack. It is possible, however, to unplug the internal speaker and connect an external speaker system to this jack. In this case, make sure the system impedance of the external speaker connected to the SPEAKER OUT jack is 8 ohms, and that the speaker can handle the full power output of the amplifier.

② LINE OUT Jack

This jack delivers a line-level output signal from the amplifier for connection to a mixing console, an external power amplifier system or other line-level equipment. The signal delivered to this jack is the same as that delivered to the internal speaker. The rated output level of the LINE OUT jacks is -10 dB.

③ EFFECT LOOP Jacks

These jacks are provided for connection to an external signal processor. The SEND jack should be connected to the input of the external signal processor, and the output from the signal processor should be connected to the RETURN jack. When the output from the signal processor are plugged into the amplifier's RETURN jack, the signal processor is effectively inserted into the amplifier's signal path. Rated input and output level for these jacks is +4 dB.

* The signal from the external effect unit is returned to the amplifier circuit immediately before the reverb system.

④ AC OUTLET (UNSWITCHED) (U.S. & Canadian models only)

Other equipment with a total power consumption of no more than 250 watts can be powered from this AC outlet.

⑤ FUSE

If the fuse blows and needs replacing, first unplug the AC power cord and then replace the fuse with a new one of exactly the same type and power rating. If the fuse blows again immediately after replacement, there may be a fault in the amplifier's circuitry. If this happens, have the amplifier checked by qualified Yamaha service personnel.

⑥ GROUND Switch (U.S. & Canadian models only)

This switch reverses the ground polarity of the AC power line. Set it to the position in which you hear the least hum and noise from the amplifier.

● SYSTEM EXAMPLE

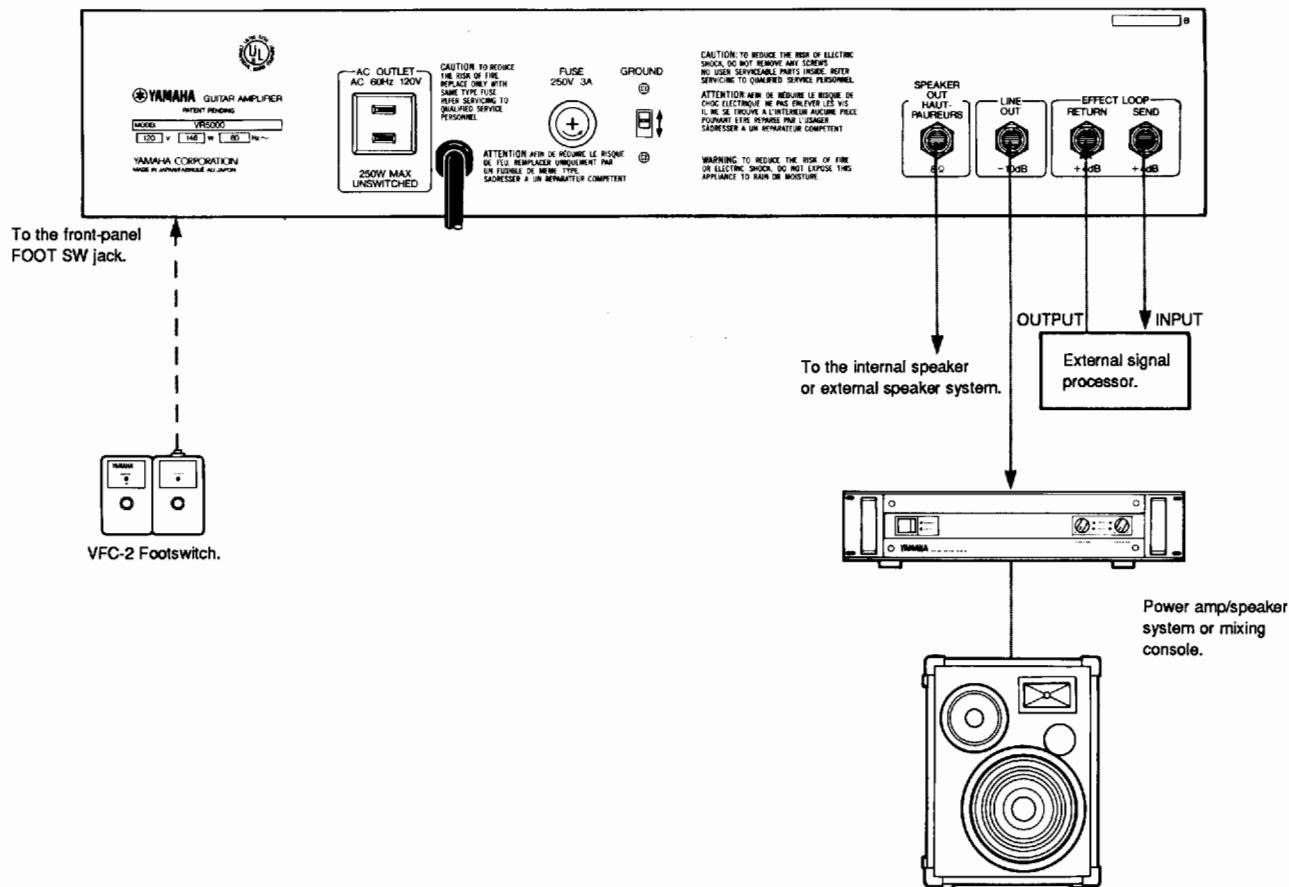

● CONTROL SETTING EXAMPLES

1. METAL SOUND

The A channel is set up to provide a bright, punchy sound that is ideal for solos. The B channel settings produce a sweet, fat tone for backing.

• VR3000

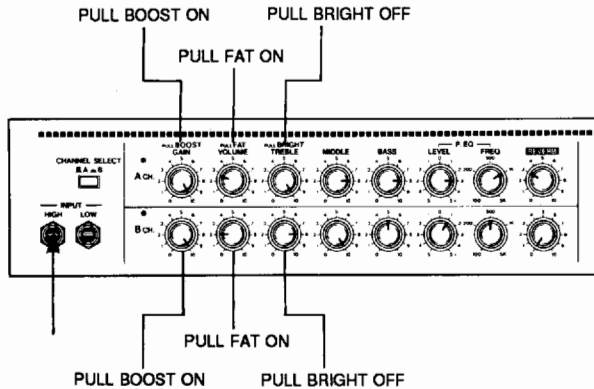

• VR5000

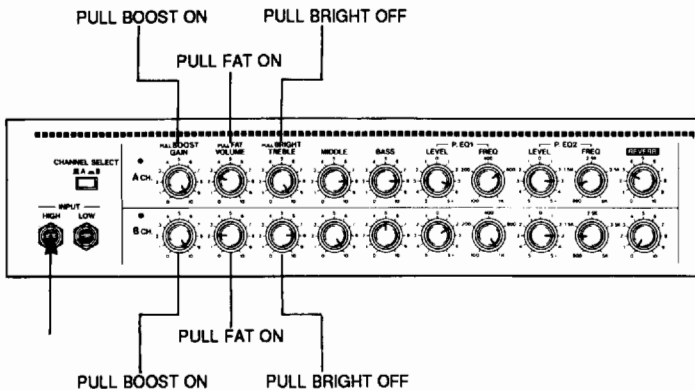

2. ROCK 'N ROLL

With the TREBLE control set to "10," the BRIGHT function ON, and gentle application of distortion, the settings shown here produce a tight, crisp sound. Set the guitar pickup selector to the rear-pickup position.

• VR3000

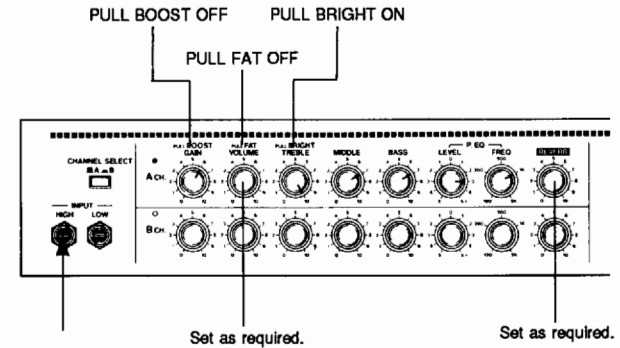

• VR5000

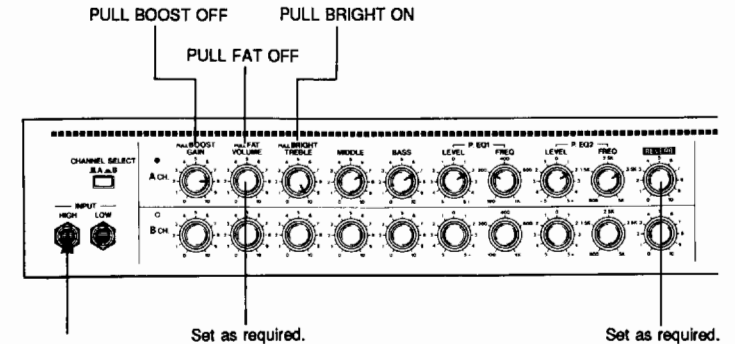

3. AMERICAN ROCK

The A channel is set up for the solo sound, with the FAT function ON for a solid, powerful tone. Reverb is added for just the right degree of warmth. The B channel provides a cleaner, flat sound that is ideal for backing.

• VR3000

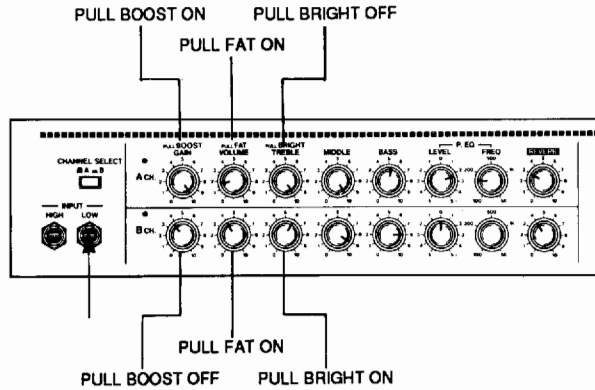

• VR5000

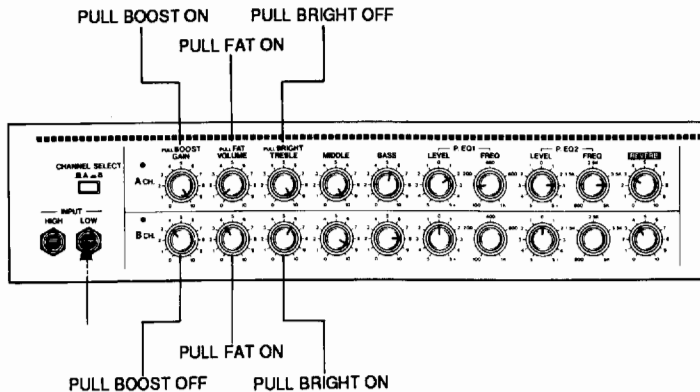

4. BLUES ROCK

The A channel settings produce a sound similar to that created by pressing a "wow" pedal down just slightly, while the B channel is set up for a flatter, more open tone. Switching between channels simulates the effect of operating a wow pedal.

• VR3000

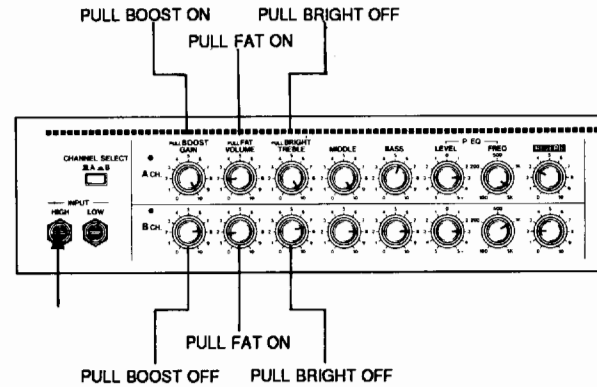

• VR5000

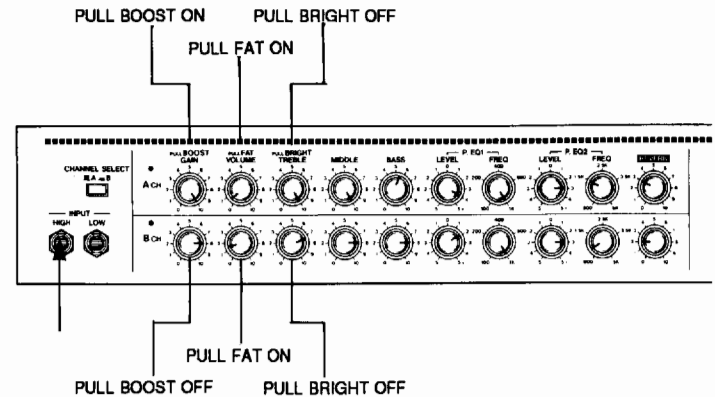

● SPECIFICATIONS

	VR3000	VR5000
Rated Output	50W rms (8Ω, 10% THD)	100W rms (8Ω, 10% THD)
Speakers	30cm x 1 (8Ω)	
Enclosure	Open-backed enclosure	
Input Sensitivity (1 kHz) INPUT A, B	HIGH: -44 dB (GAIN & VOLUME max.) LOW: -32 dB (GAIN & VOLUME max.)	
Input Level EFFECT RTN	+4 dB (47kΩ)	
Output Level SP OUT LINE OUT EFFECT SEND PHONES	See "Rated Output" -10 dB (600Ω) +4 dB (600Ω) 100 mW (8Ω)	
Noise (IHF-A) A, B CHANNEL	-21 dB (GAIN /VOL. max., Pull BOOST) -51 dB (GAIN min., VOLUME max.) -64 dB (GAIN & VOLUME min.)	
Pull BOOST	+10 dB boost	
Pull FAT	+10 dB boost at 400 Hz	
Tone Controls TREBLE MIDDLE BASS	±15 dB at 5 kHz (Pull BRIGHT: +12 dB boost) +10, -5 dB at 800 Hz +5, -15 dB at 80 Hz	

	VR3000	VR5000
Parametric Equalizer P.EQ FREQ	100 Hz — 5 kHz	P.EQ 1 100 Hz — 1 kHz P.EQ 2 800 Hz — 5 kHz
P.EQ LEVEL	±15 dB variable	
Reverb Control REVERB	Spring reverb, variable	
Switches	POWER ON/OFF, CHANNEL SELECT, GROUND	
Power Requirements US & Canadian Models General Model	120V AC, 60 Hz 110/120/220/240V AC, 50/60 Hz	
Power Consumption US & Canadian Models General Model	90 W 117 W	146 W 198 W
Dimensions (W x H x D)	529 x 541 x 275 mm (20-7/8" x 21-1/4" x 10-7/8")	
Weight	18.7 kg (41.2 lbs.)	20.4 kg (45 lbs.)

* 0dB is referenced to 0.775V RMS.

* Specifications subject to change without notice.

● BLOCK DIAGRAM

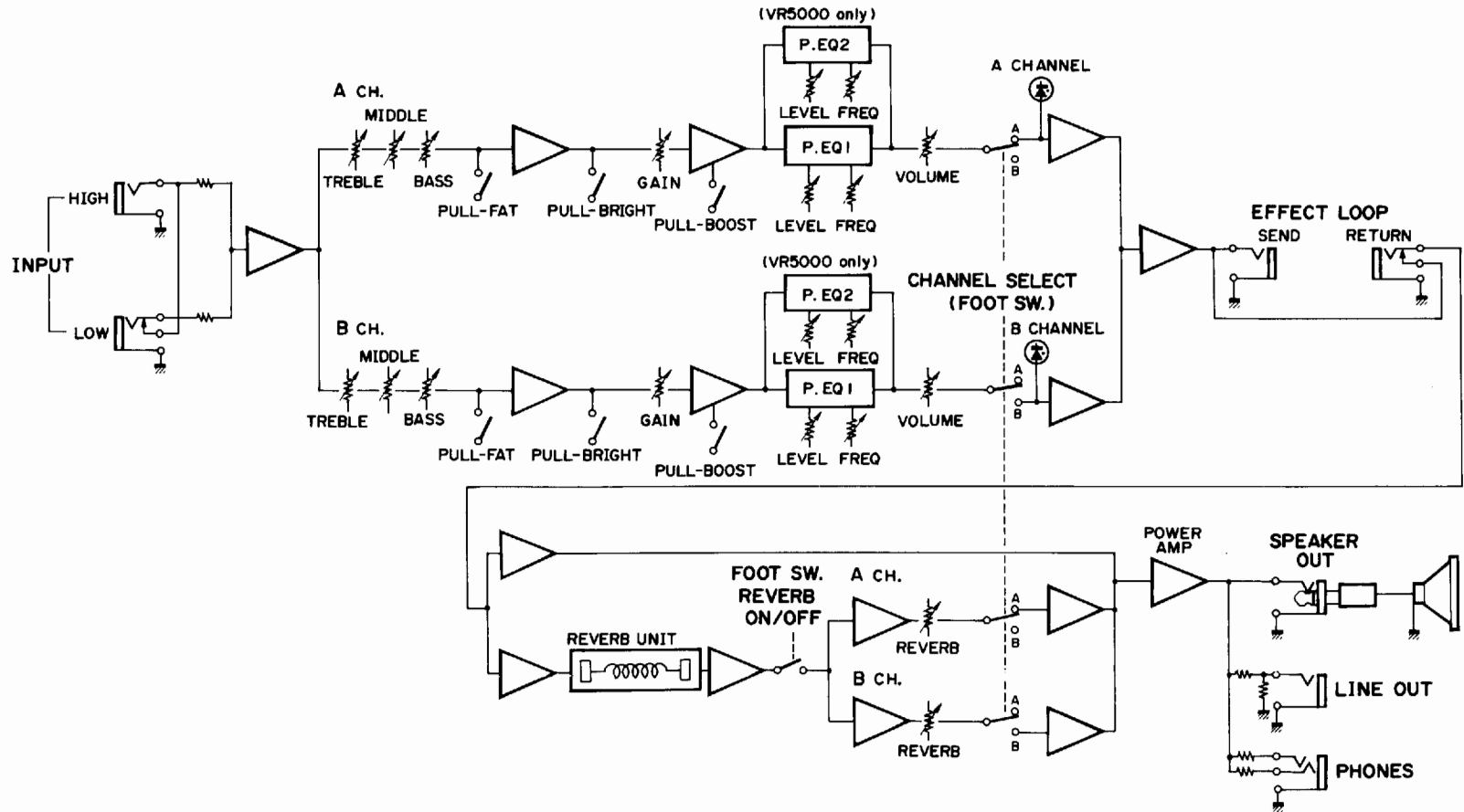

SERVICE

This product is supported by Yamaha's worldwide network of factory trained and qualified dealer service personnel. In the event of a problem, contact your nearest Yamaha dealer.