

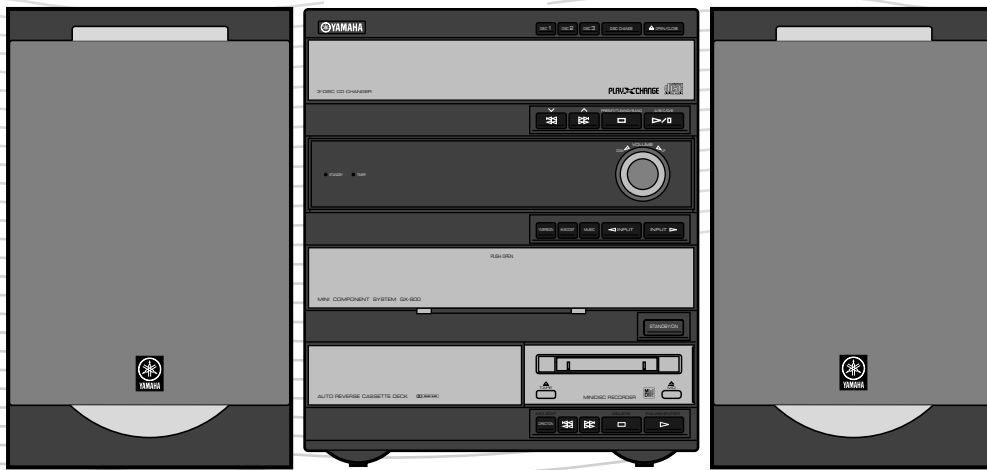

GX-900

MINI COMPONENT SYSTEM



OWNER'S MANUAL



Unpacking

After unpacking, check that the following parts are contained.

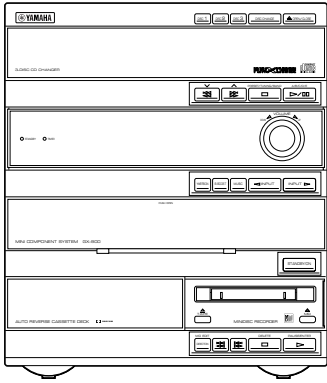
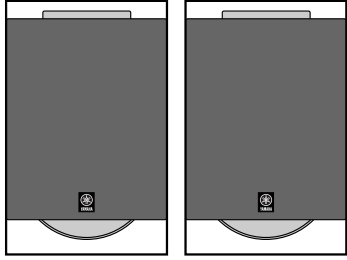
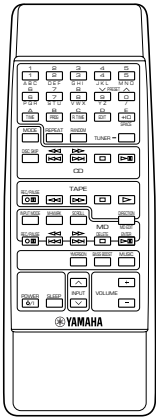
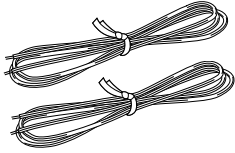
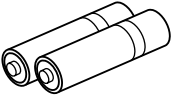
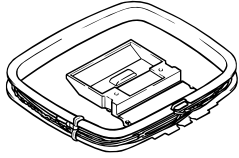
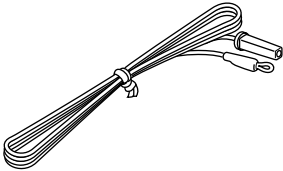
<p>Main unit</p>  A detailed line drawing of the Yamaha car stereo main unit, showing various controls, buttons, and the cassette slot.	<p>Speakers</p>  Two rectangular speakers with a circular tweeter at the bottom center.
<p>Remote control</p>  A vertical remote control with numerous buttons for various functions, including power, volume, and preset stations.	<p>Speaker cords</p>  Two bundles of speaker wires, each with a different color coding.
<p>Batteries (size AA, UM/SUM-3, R6, HP-7)</p>  Two AA batteries shown side-by-side.	<p>AM loop antenna</p>  A square-shaped AM loop antenna with a central coil and a sliding cover. <p>Indoor FM antenna</p>  A long, thin indoor FM antenna with a coiled section and a connector at the end.

Setting this system

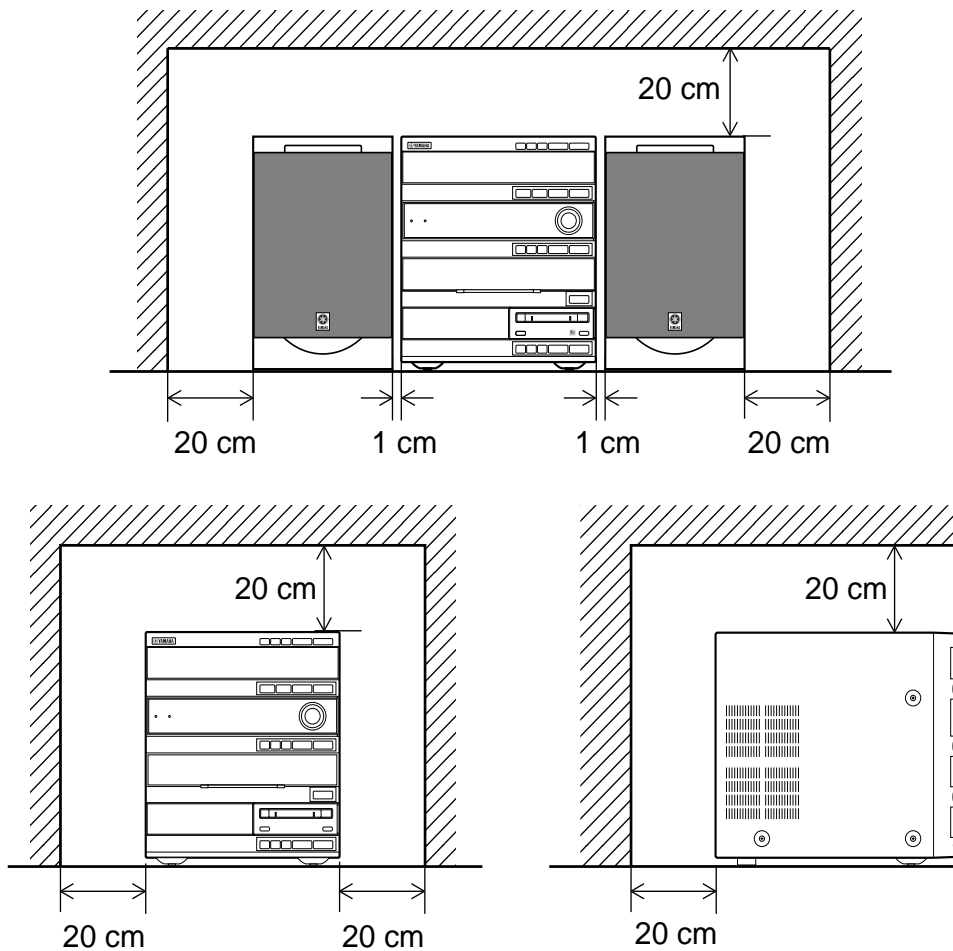

Set this system allowing enough spaces around and behind the main unit to assure good ventilation. Be sure not to place another unit or any object on top of the main unit to prevent the ventilation holes from being obstructed. Otherwise, it may cause fire or damage to the main unit.

Note

When placing the speakers apart from the main unit, be sure to allow a space of at least 20 cm above, behind and on both sides of the main unit. If the main unit is put in a rack, the front of it must be fully opened.

* The values must be applied to China and Singapore models only.

Front panel

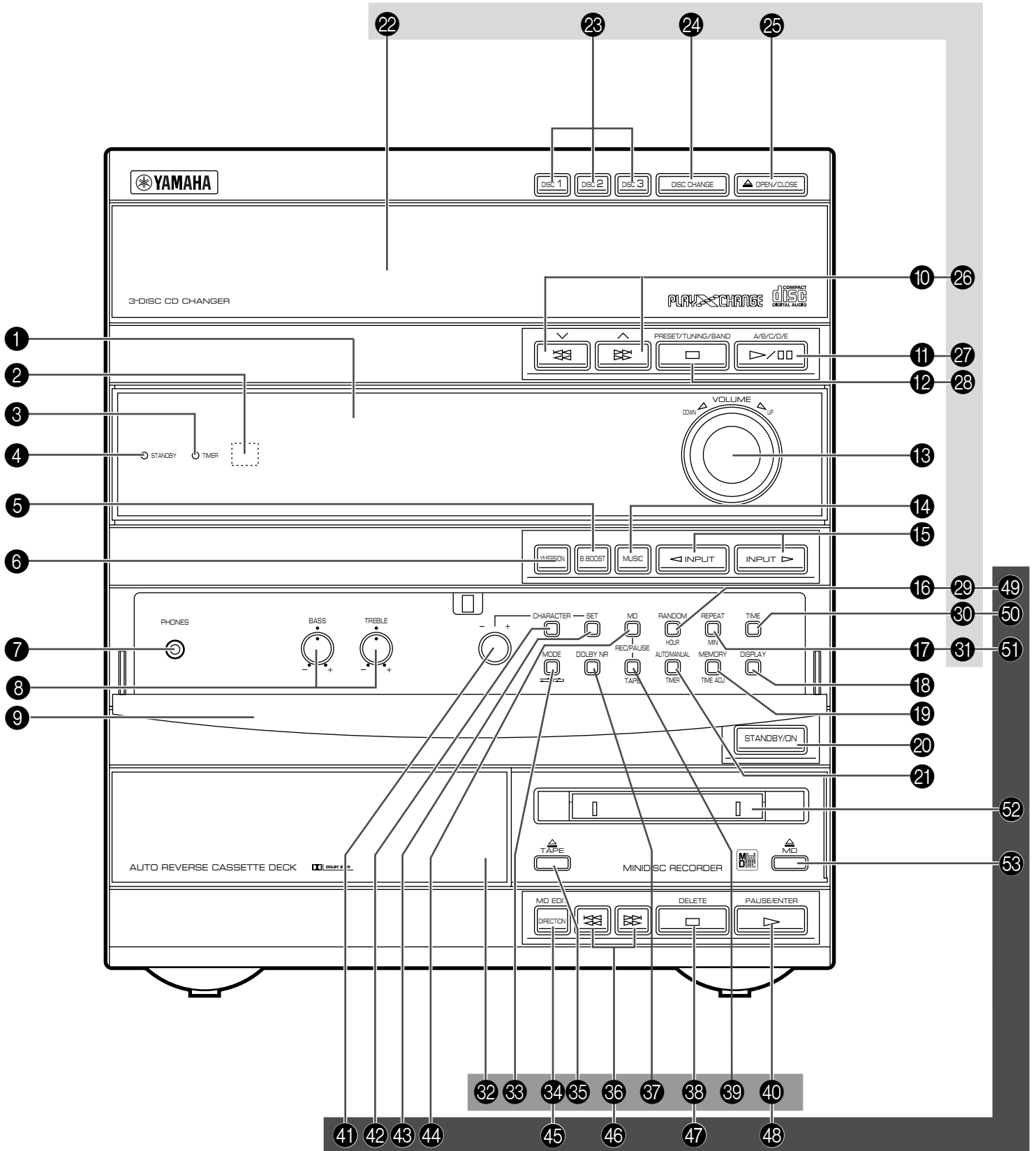

Amplifier/tuner

- | | | |
|-------------------------|----------------------------------------------------------------------------------------------------------------------------------------------------------------------------------------------------|------------------------------------------|
| 1 Display panel | 9 Front cover | 16 HOUR [p. 7, 42] |
| 2 Remote control sensor | 10 \wedge/\vee [p. 15, 16] | 17 MIN [p. 7, 42] |
| 3 TIMER | 11 A/B/C/D/E [p. 16] | 18 DISPLAY [p. 7, 42] |
| 4 STANDBY [p. 9] | 12 PRESET/TUNING/BAND [p. 15] | 19 MEMORY [p. 16, 17]
TIME ADJ [p. 7] |
| 5 B. BOOST [p. 41] | 13 VOLUME [p. 40] | 20 STANDBY/ON [p. 9] |
| 6 YMERSION [p. 41] | 14 MUSIC [p. 40] | 21 AUTO/MANUAL [p. 15]
TIMER [p. 42] |
| 7 PHONES [p. 41] | 15 INPUT ($\triangleleft/\triangleright$)
[p. 9, 15, 19, 27, 39]
TUNER \rightarrow TAPE \rightarrow CD \rightarrow MD
\uparrow AUX Analog \leftarrow AUX Digital \downarrow | |
| 8 BASS/TREBLE [p. 41] | | |

CD player

- | | | |
|---------------------------|--------------------------------------|---------------------|
| 22 Disc tray [p. 9] | 25 OPEN/CLOSE [p. 9] | 28 \square [p. 9] |
| 23 DISC (1, 2, 3) [p. 10] | 26 $\lll (\lll)/\ggg (\ggg)$ [p. 10] | 29 RANDOM [p. 12] |
| 24 DISC CHANGE [p. 10] | 27 \triangleright/\square [p. 9] | 30 TIME [p. 13] |
| | | 31 REPEAT [p. 12] |

Tape deck

- | | | |
|----------------------|--------------------------------------|-----------------------------|
| 32 Tray [p. 19] | 35 TAPE \triangle [p. 19] | 38 \square [p. 19] |
| 33 MODE [p. 19] | 36 $\lll (\lll)/\ggg (\ggg)$ [p. 20] | 39 TAPE REC/PAUSE [p. 21] |
| 34 DIRECTION [p. 19] | 37 DOLBY NR [p. 18, 21] | 40 \triangleright [p. 19] |

MD recorder

- | | | |
|-------------------------|--------------------------------------------------------|--------------------------------|
| 41 Jog dial [p. 35] | 45 MD EDIT [p. 35] | 49 RANDOM [p. 29] |
| 42 CHARACTER [p. 38] | 46 $\lll (\lll)/\ggg (\ggg)$ [p. 27] | 50 TIME [p. 28] |
| 43 SET [p. 38] | 47 \square [p. 27]
DELETE [p. 38] | 51 REPEAT [p. 29] |
| 44 MD REC/PAUSE [p. 30] | 48 \triangleright [p. 27]
PAUSE/ENTER [p. 30, 35] | 52 Disc insertion slot [p. 27] |
| | | 53 MD \triangle [p. 27] |

Remote control

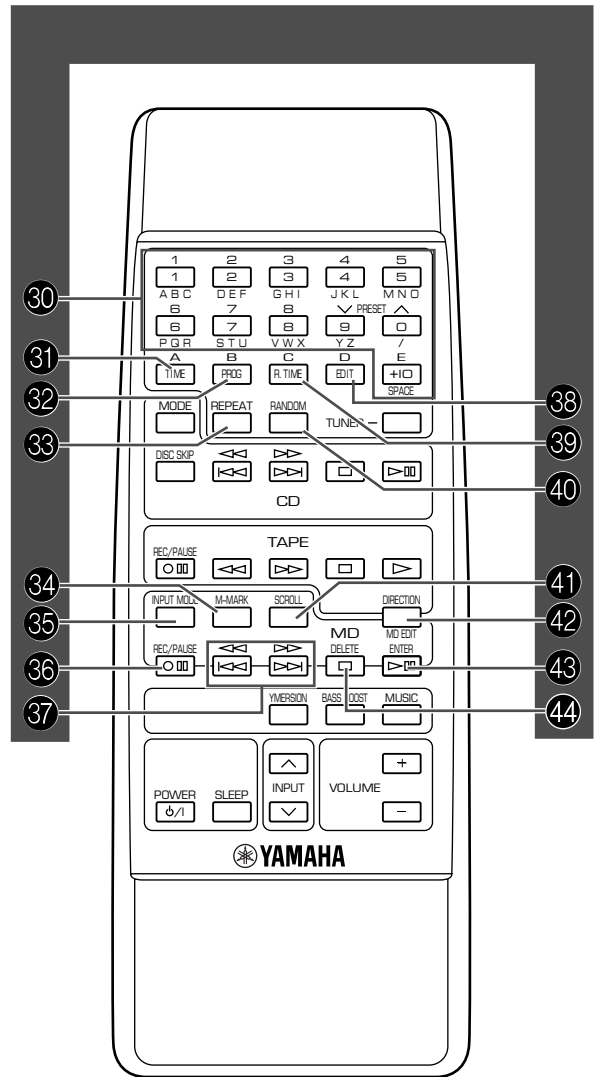
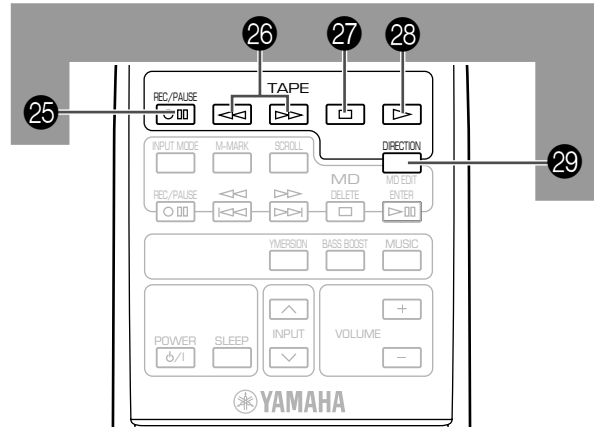
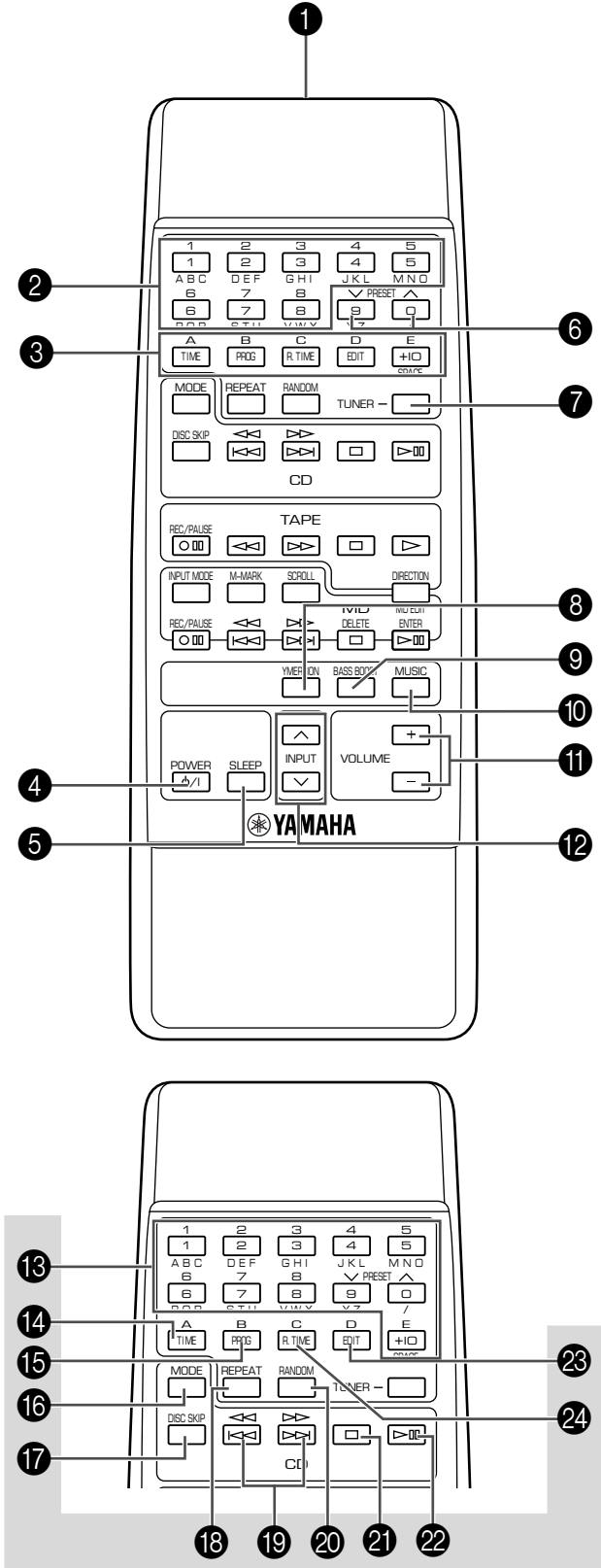

Amplifier/tuner

- | | | |
|------------------------------|----------------------------|--------------------------------------------------------|
| 1 Transmission window [p. 4] | 6 PRESET (^ / ∨) [p. 16] | 11 VOLUME (+/-) [p. 40] |
| 2 Numeric buttons [p. 16] | 7 TUNER [p. 15] | 12 INPUT (^ / ∨)
[p. 9, 15, 19, 27, 39] |
| 3 A, B, C, D, E [p. 16] | 8 YMERSION [p. 41] | TUNER → TAPE → CD → MD
↑ AUX Analog ← AUX Digital ↓ |
| 4 POWER [p. 9] | 9 BASS BOOST [p. 41] | |
| 5 SLEEP [p. 43] | 10 MUSIC [p. 40] | |

CD player

- | | | |
|----------------------------|----------------------------|--------------------|
| 13 Numeric buttons [p. 10] | 17 DISC SKIP [p. 10] | 21 □ [p. 9] |
| 14 TIME [p. 13] | 18 REPEAT [p. 12] | 22 ▷ ■ [p. 9] |
| 15 PROG [p. 11] | 19 ◀◀ (◀◀)/▶▶ (▶▶) [p. 10] | 23 EDIT [p. 23] |
| 16 MODE [p. 9] | 20 RANDOM [p. 12] | 24 R. TIME [p. 23] |

Tape deck

- | | | |
|----------------------|--------------|----------------------|
| 25 REC/PAUSE [p. 21] | 27 □ [p. 19] | 29 DIRECTION [p. 19] |
| 26 ◀◀/▶▶ [p. 20] | 28 ▷ [p. 19] | |

MD recorder

- | | | |
|---------------------------------------------------------|----------------------------|-------------------------------------|
| 30 Numeric buttons [p. 27]
Character buttons [p. 38] | 35 INPUT MODE [p. 30] | 40 RANDOM [p. 29] |
| 31 TIME [p. 28] | 36 REC/PAUSE [p. 30] | 41 SCROLL [p. 28] |
| 32 PROG [p. 29] | 37 ◀◀ (◀◀)/▶▶ (▶▶) [p. 27] | 42 MD EDIT [p. 35] |
| 33 REPEAT [p. 29] | 38 EDIT [p. 32] | 43 ▷ ■ [p. 27]
ENTER [p. 30, 35] |
| 34 M-MARK [p. 31] | 39 R. TIME [p. 32] | 44 □ [p. 27]
DELETE [p. 38] |

Thank you for purchasing this YAMAHA product. We hope it will give you many years of trouble-free enjoyment.
For the best performance, read this manual carefully. It will guide you in operating your YAMAHA product.

Contents

	Page		Page
Precautions	1	Playing an MD	26
Features	3	General information	26
Preparations and connections	4	Basic play	27
Installing batteries in the remote control	4	To select the desired track directly	27
Remote control operation range	4	To play the desired track (Skip)	27
Connections	5	To advance or reverse play rapidly (Search)	27
Setting the clock	7	Switching the display	28
Adjusting brightness of the display	7	Program play	29
Compact disc player operation	8	Repeat play	29
Basic Play	9	Random play	29
To change the disc play mode	9	Recording to MD	30
To select another disc	10	Basic recording	30
To select the desired track directly	10	Monaural recording	31
To play the desired track (Skip)	10	Track-marking	31
To advance or reverse play rapidly (Search)	10	Recording from CDs utilizing the EDIT function	32
To exchange a disc (or discs) while playing (PLAYXCHANGE)	10	Editing and titling MD	34
Program play	11	Editing an MD	34
Random play	12	Titling an MD or track	38
Repeat play	12	Operating an external unit connected with this system	39
Switching the time display	13	Various sound control	40
Tuning operation	14	Using the built-in timer	42
Automatic tuning	15	Timer play	42
Manual tuning	15	Timer recording	43
Manual preset tuning	16	Sleep timer operation	43
Automatic preset tuning	17	Appendix	44
Playing back a tape	18	Troubleshooting	44
General information	18	MD system limitations	46
Basic operation	19	Copy protection (SCMS)	46
Winding the tape	20	Display messages for MD recorder	47
Searching for the beginning of the desired selection	20	Specifications	48
Recording to tape	21		
Basic recording	21		
Recording from CDs utilizing the EDIT function	23		

For basic source play, the following illustrations on top of pages will help you to look for the section you need.



..... CD play



..... Tape playback/recording



..... Tuning



..... MD play/recording

Precautions: Read this before operating your system

- To assure the finest performance, please read this manual carefully. Keep it in a safe place for future reference.
 - Choose the installation location of this system carefully. Avoid placing it in direct sunlight or close to a source of heat. Also avoid locations subject to vibration and excessive dust, heat, cold or moisture. Keep it away from sources of hum such as transformers and electric motors.
 - Do not operate this system upside-down. It may overheat, possibly causing damage.
 - Never open the cabinet. If something drops into the set, contact your dealer.
 - The openings on the main unit cover assure proper ventilation of the main unit. If these openings are obstructed, the temperature inside the unit will rise rapidly. Therefore, avoid placing objects against these openings, and install the main unit in a well-ventilated area to prevent fire and damage.
 - Always set the VOLUME control to minimum before starting an audio source play: increase the volume gradually to an appropriate level after play has started.
 - When not planning to use this system for long periods of time (ie., vacation, etc.), disconnect the AC power plug from the wall outlet.
 - Grounding or polarization – Precautions should be taken so that the grounding or polarization of this system is not defeated.
 - Do not use force on switches, controls or connection wires. When moving the main unit, first disconnect the power plug and the wires connected to other equipment. Never pull the wire itself.
 - If an external appliance (TV, radio, etc.) interferes with this system operation, move the main unit away from such an appliance.
 - Do not attempt to clean this system with chemical solvents; this might damage the finish. Use a clean, dry cloth.
 - Be sure to read the “Troubleshooting” section regarding common operating errors before concluding that this system is faulty.
 - To prevent lightning damage, disconnect the AC power plug and the antenna cable when there is an electrical storm.
 - Do not plug the AC power plug to the wall socket before you finish all connections.
 - Never allow metallic items (e.g. screwdrivers, tools, etc.) to come near the tape deck’s record/playback head assembly. Doing so may not only scratch or damage the head’s mirror-smooth finish, it may change the magnetic characteristics of the heads, causing a deterioration in reproduction performance quality.
 - Although the tape deck’s record/playback heads are high quality heads with outstanding reproduction characteristics, they can become dirty through the use of old tapes or from dust accumulation over time. This can have a serious effect on reproduction quality. Clean the heads regularly with one of the commonly available head cleaners or with cleaning solutions.
 - The voltage to be used must be the same as that specified on this system. Using this system with a higher voltage than specified is dangerous and may result in a fire or other types of accidents causing damage. YAMAHA will not be held responsible for any damage resulting from use of this system with a voltage other than specified.
 - The sound level at a given volume setting depends on speaker location and other factors. Care should be taken to avoid exposure to sudden high levels of sound, which may occur when turning on this system with the volume control setting at high, and to continuous high levels of sound.
 - Sudden temperature changes and storage or operation in an extremely humid environment may cause condensation inside the cabinet. Condensation can cause this system to malfunction.
- To eliminate condensation:
- **CD pickup/MD pickup**
Leave the power on with no disc loaded until normal play becomes possible (about 1 hour).
 - **Tape head**
Leave the power on with no tape loaded until normal playback becomes possible (about 1 hour).
Note
If condensation forms on the tape head, dirt or dust may accumulate during use.
 - **Remote control**
Wipe off condensation on the transmission window with a soft cloth before operating this system.
- To prevent a malfunction of this system:
- Do not use any non standard shaped compact disc (heart etc.) available on the market, because it may damage this system.
 - Do not use a compact disc with tape, seals, or paste on it, because damage to this system may result.
- This system is not disconnected from the AC power source as long as it is connected to the wall outlet, even if this system itself is turned off. This state is called the standby mode. In this state, this system is designed to consume a certain level of power.
- Note**
Please check the copyright laws in your country to record from records, compact discs, minidisks, radio, etc. Recording of copyright material may infringe copyright laws.

Precautions: Read this before operating your system

CAUTION FOR CARRYING THE MAIN UNIT

Be sure not to carry or tip the main unit with discs remaining in it.

CAUTION FOR MOVING THE MAIN UNIT

Before moving the main unit, first remove all compact discs from the disc tray and close the tray by pressing the **OPEN/CLOSE** button. After you confirm that "NO DISC" lights up on the display, turn this system into the standby mode by pressing the **STANDBY/ON** switch, and then disconnect the power plug from the AC outlet.

CAUTION

Use the minidisc recorder only in accordance with the instructions given in this manual and do not attempt to interfere with the interlock switch or make any other adjustments as this may result in exposure to hazardous radiation.

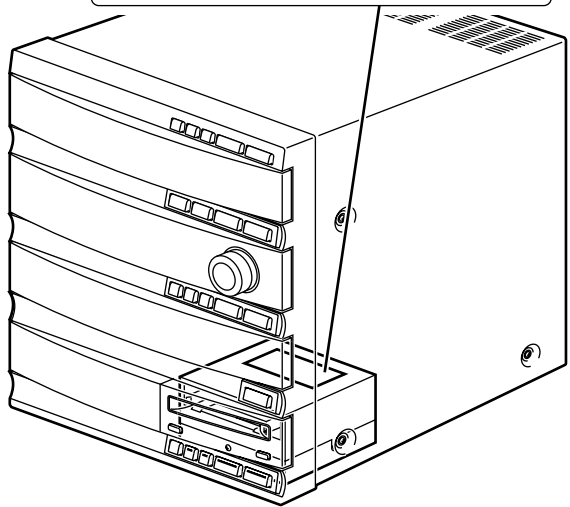

IMPORTANT

Please record the serial number of this system in the space below.

Model:

Serial No.:

The serial number is located on the rear of the main unit. Retain this Owner's Manual in a safe place for future reference.

WARNING

TO REDUCE THE RISK OF FIRE OR ELECTRIC SHOCK, DO NOT EXPOSE THIS APPLIANCE TO RAIN OR MOISTURE.

WARNING

To reduce the risk of fire or electric shock, do not expose this system to rain or moisture.

To avoid electrical shock, do not open the cabinet. Refer servicing to qualified personnel only.

CAUTION

Use of controls or adjustments or performance of procedures other than those specified herein may result in hazardous radiation exposure.

As the laser beam used in this system is harmful to the eyes, do not attempt to disassemble the cabinet. Refer servicing to qualified personnel only.

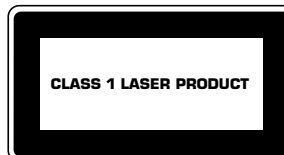

This system is classified as a CLASS 1 LASER product. The CLASS 1 LASER PRODUCT label is located on the rear exterior.

Laser component in this product is capable of emitting radiation exceeding the limit for Class 1.

Features

General

- High Power Output
80W + 80W (6Ω) RMS, 0.9% THD, 1 kHz
- Multi-use Timer/Sleep Timer
- SUBWOOFER Output for Low Frequency Expansion
- Remote Control Capability
- YMERSION
- BASS BOOST
- 5-Band Spectrum Analyzer
- 3 Preset Graphic Equalizer Modes (ROCK, POPS and JAZZ)

Compact Disc Player

- 3-Disc Carousel Type CD Changer
- PLAYXCHANGE
Disc changing while playing
- 20-Track Random Access Programming
- Repeat Play for Single Track/Entire Disc/
All Discs
- Random Sequence Play

Tuner

- 40 Station Preset Tuning
- Automatic Preset Tuning

Tape Deck

- Automatic Synchronized Recording with CD or MD
- EDIT Function Useful for Recording CD or MD
- Automatic Reverse
- Dolby B Type Noise Reduction System

Minidisc Recorder

- Random Access Programmable Play
- Random-Sequence Play
- Repeat Play
- Sampling Rate Converter
- Editing Features (Erase, Move, Combine, Divide, Title and Undo)
- Optical Digital Input Terminal
- Monaural Recording up to 148 Minutes of Audio onto an MD
- EDIT Function Useful for Recording CD(s)

Preparations and connections

Installing batteries in the remote control

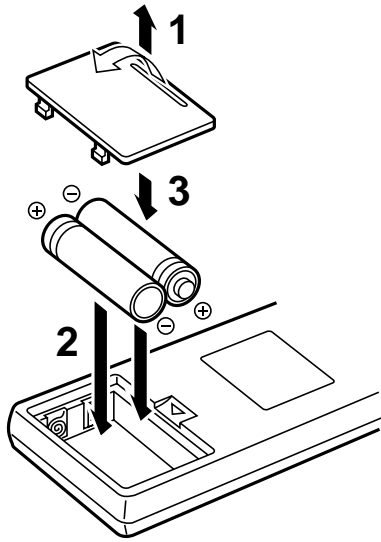

1. Turn the remote control over and remove the battery compartment cover by pulling it up while pressing the edge of the cover in the direction of the ∇ mark.
2. Insert the batteries (AA, R6, UM-3 type) according to the polarity markings on the inside of the battery compartment.
3. Attach the battery compartment cover.

Notes

- Remove the batteries if the remote control is not used for an extended period of time.
- If batteries leak, dispose of them immediately. Avoid touching the leaked material and contact with clothing, etc. Clean the battery compartment thoroughly before installing new batteries.
- Be sure to use the same type of batteries together.
- Do not use a new battery and an old battery together.

Remote control operation range

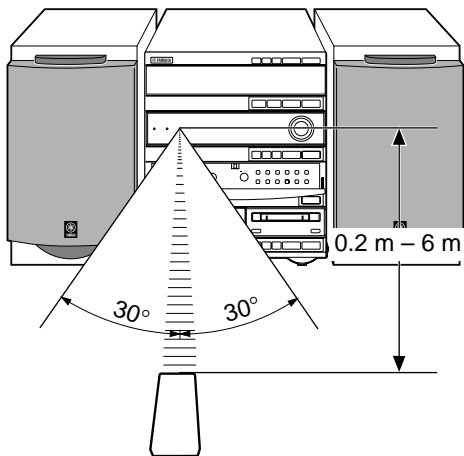

Notes

- The area between the remote control and the main unit must be clear of large obstacles.
- Do not expose the remote control sensor to strong lighting, in particular, an inverter type fluorescent lamp. Otherwise, the remote control may not work properly. If necessary, position the main unit away from direct lighting.

Battery replacement

If you find that the remote control must be used closer to the main unit, the batteries are weak. Replace both batteries with new ones.

Connections

Never plug the AC supply lead of this system into the AC outlet until all connections are completed.

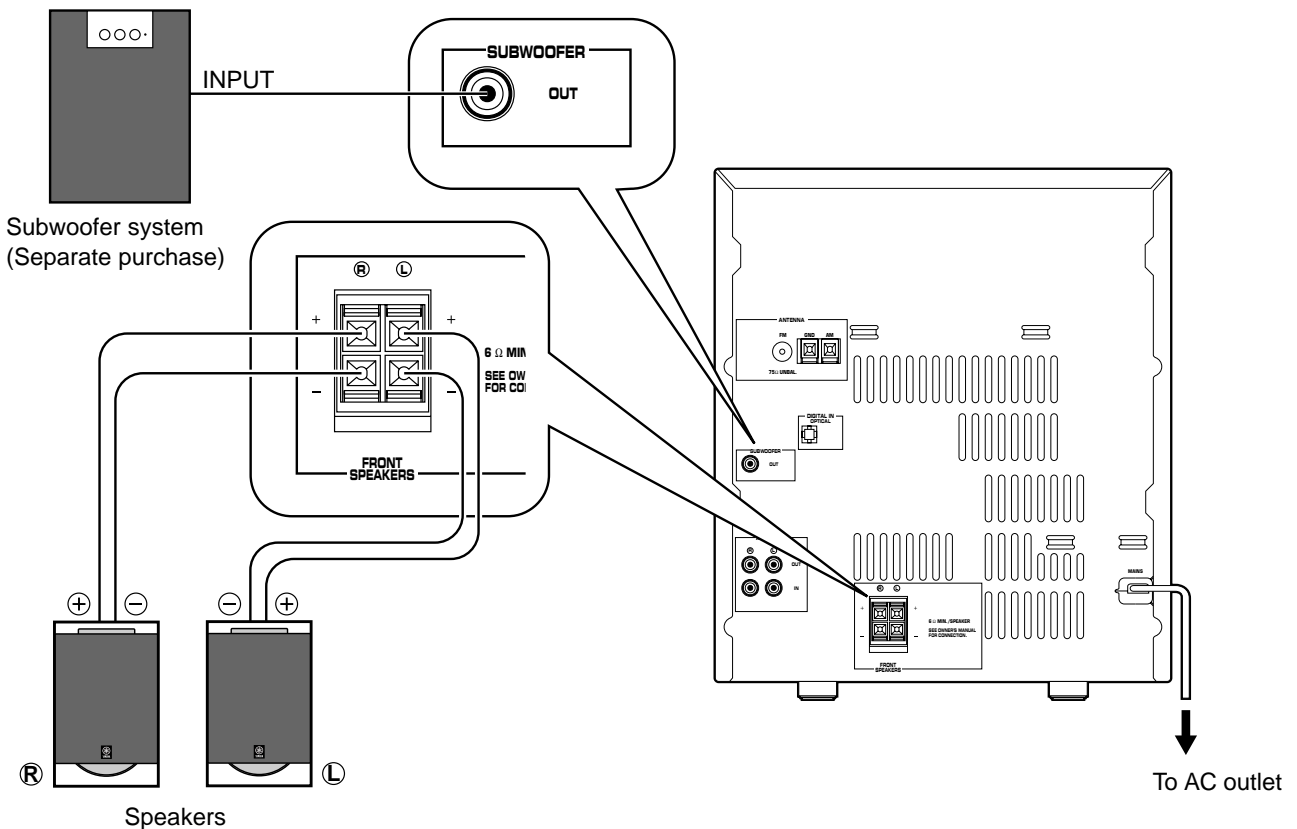

■ Connecting speakers

Connect the speakers to the corresponding speaker terminals on the rear of the main unit respectively by using the speaker cords. Make sure that the polarity of the speaker cords is correct, that is the + and – markings are observed. If these cords are reversed, the sound will be unnatural and lack bass.

On the speakers

Red: positive (+)
Black: negative (–)

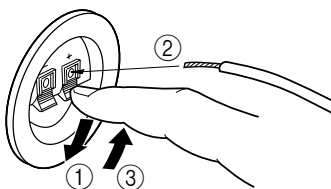

- ① Press the tab
- ② Insert the bare wire.
[Remove approx. 5mm (1/4") insulation from the speaker wires.]
- ③ Release the tab and secure the wire.

On the main unit

Red: positive (+)
Black: negative (–)

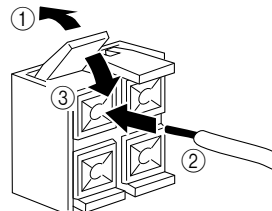

- ① Press up the tab.
- ② Insert the bare wire.
[Remove approx. 5mm (1/4") insulation from the speaker wires.]
- ③ Press down the tab and secure the wire.

Caution

Do not let the bare speaker wires touch each other as this could damage the amplifier and/or speakers.

When connecting a subwoofer (separate purchase)

You may wish to add a subwoofer to reinforce the bass frequencies.

When connecting a subwoofer to this system, connect the SUBWOOFER OUT terminal of this system to the INPUT terminal of the subwoofer.

* Ordinary subwoofers, including the Yamaha Active Servo Processing Subwoofer System, are designed so that the amplifier and subwoofer are in the same unit.

* The SUBWOOFER OUT terminal outputs low frequencies from both left and right channels.
(The cut-off frequency of this terminal is 200 Hz.)

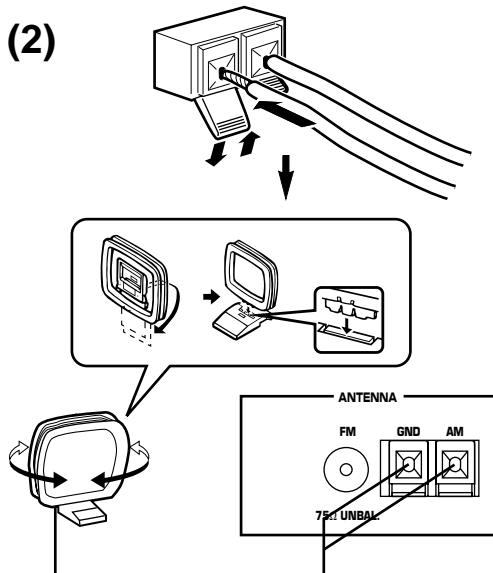
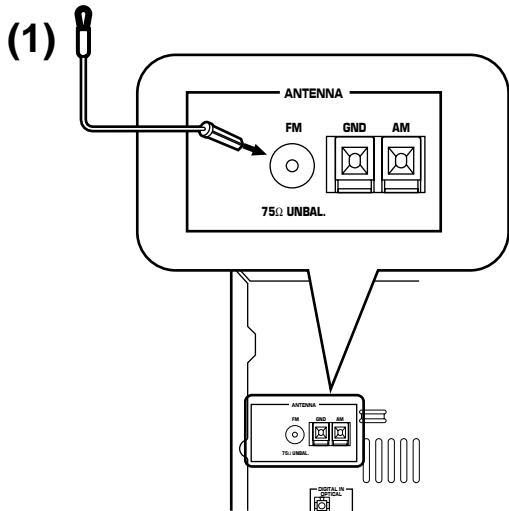

Antenna connection

(1) Supplied FM antenna

Connect the FM antenna wire to the corresponding terminal and direct the FM antenna wire to the direction where the strongest signal can be received.

(2) Supplied AM loop antenna

Connect the AM loop antenna wires to the corresponding terminals. Position the AM loop antenna for optimum reception.

Notes

- When static is still heard even after adjusting the position of the AM loop antenna, try reversing the wire connections (from the right terminal to the left one, and vice versa).
- The AM loop antenna should be placed apart from the main unit. The antenna may be hung on a wall.

Using an external antenna

- Use an external FM antenna instead of an indoor FM antenna if you need better reception. Consult your dealer.
- Use an external AM antenna if you need better reception. Consult your dealer.

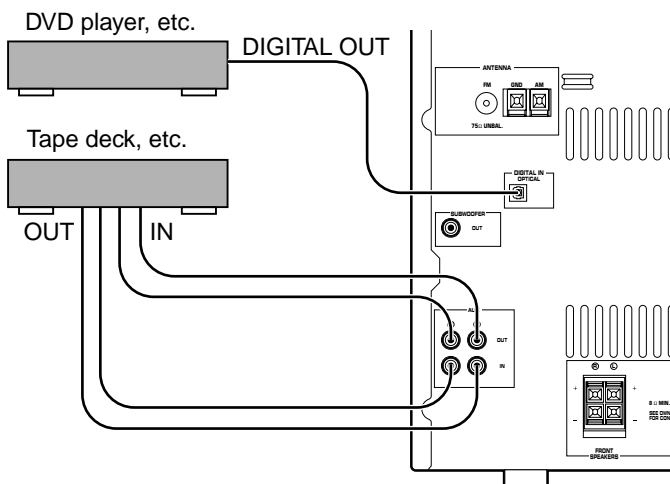

Connecting external components

This system can be connected with external audio components.

- Connect an audio component to the AUX terminals on the rear of the main unit by using RCA pin plug connector cables correctly, that is to say **L** (left) to **L** and **R** (right) to **R**. Also, refer to the owner's manual for the component to be connected to this system.
If a tape deck is connected to the AUX (OUT) terminals, a source played on this system or radio program can be recorded with the tape deck.
- A digital-to-digital recording is possible from an external LD (DVD) player, satellite tuner, DAT, etc. connected to the DIGITAL IN (OPTICAL) terminal on the rear of the main unit to the built-in MD recorder.

Setting the clock

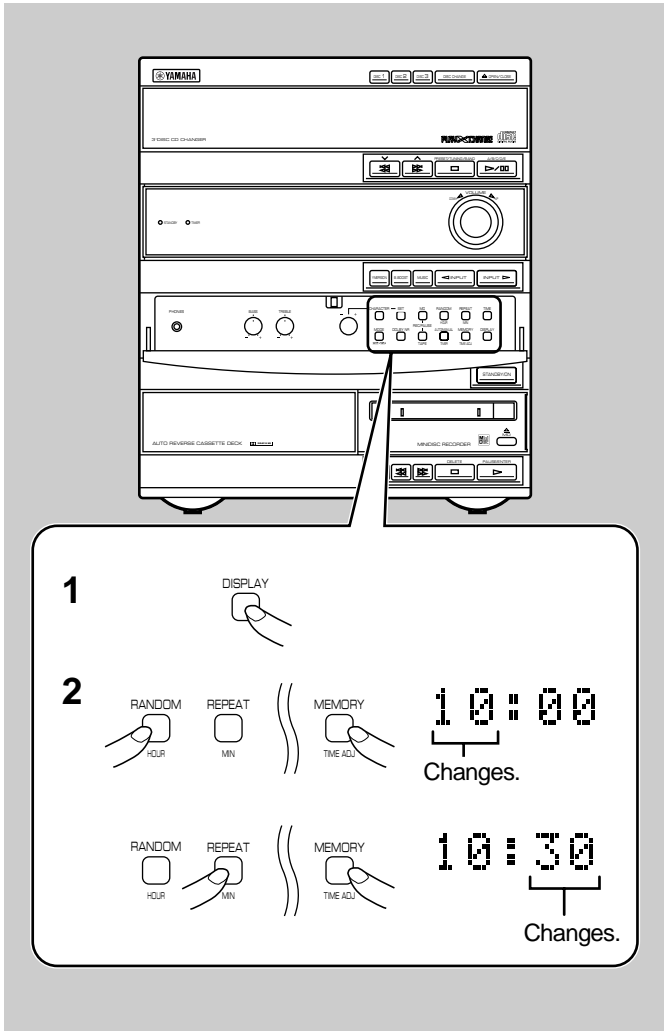

- 1** While the power is on, press **DISPLAY** to display the time.
- 2** While holding **TIME ADJ** pressed, press **HOUR** and set the hour.
 - * Press **HOUR** once to advance the time by 1 hour. Press and hold to advance continuously.
- 3** While holding **TIME ADJ** pressed, press **MIN** and set the minute.
 - * Press **MIN** once to advance the time by 1 minute. Press and hold to advance continuously.
 - * The hour setting will not advance even if minute is advanced from "59" to "00".

Note

In the event of a power failure or when the AC supply lead is disconnected, the time display will go out, however, the clock will function for about 5 minutes without any power supply. Otherwise, the time display will flash on and off to indicate that the time must be reset.

Adjusting brightness of the display

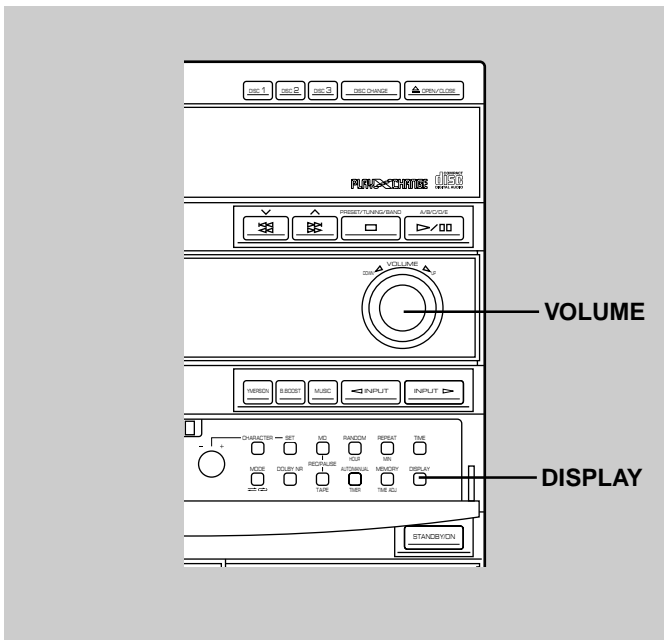

If desired, you can adjust the brightness of the display.

Press and hold **DISPLAY** for more than 2 seconds so that "DIMMER ±0" appears on the display. While holding **DISPLAY** pressed, turn **VOLUME** clockwise to increase or counterclockwise to decrease brightness.

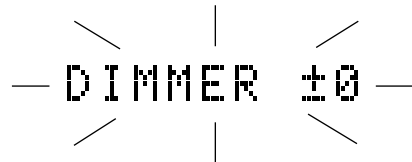

Control range: ±0 to -6 (Preset value: ±0)

Compact disc player operation

Display information

Each indicator mentioned with a number on pages 9–13 corresponds to the indicator with the same number on this page.

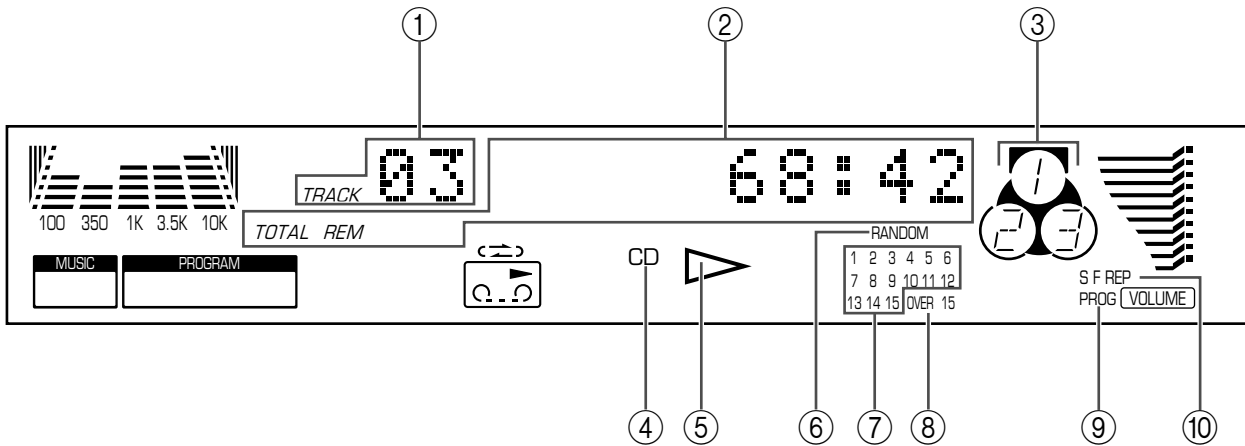

① **TRACK (Track number)**

② **Time display**

③ **Disc indicator**

The disc of the number located on the top of this indicator is now being selected.

④ **CD (input source indicator)**

⑤ **▷ (play)**

⑥ **RANDOM**

⑦ **Music calendar**

Track numbers on the currently selected disc will be illuminated (up to the number 15).

⑧ **OVER 15**

This indicator will be illuminated when the currently selected disc has more than 15 tracks.

⑨ **PROG (program)**

⑩ **(S, F) REP [(single, full) repeat]**



Basic play

- 1 Turn on the power.
- 2 Select the CD player by pressing **INPUT** ▷ or ◁ until "CD" (②, ④) appears on the display.
- 3 Press **OPEN/CLOSE** to open the disc tray.
- 4 Place discs on the table, label side upward.
 - * Up to three discs can be loaded on the table.
 - To load the third disc, rotate the disc table by pressing **DISC CHANGE** on the front panel.
 - * 8 cm (3") discs can be played without an adaptor.
 - * The disc placed on the left side is played first.
- 5 Press **OPEN/CLOSE** to close the disc tray.
 - * The total number of tracks (①) and the total playing time of the disc being selected (②) will be displayed for several seconds.
 - * If the compact disc contains more than 15 tracks, the "OVER 15" indicator (⑧) will light up.
 - * If the disc tray is closed by pushing the front edge of the tray, play will begin automatically.
- 6 Press ▷/⏏ to begin play.

To pause

- 1 Press ▷/⏏.
 - * The "▷" indicator (⑤) will flash.
- 2 Press ▷/⏏ to resume play from the same point.

To stop play

Press □.

To finish using this system

Turn this system into the standby mode by pressing **STANDBY/ON**. (The **STANDBY** indicator will light up and the display will go out.)

Direct operation

DISC (1, 2 or 3) and **OPEN/CLOSE** on the front panel and ▷/⏏ on the remote control will work if they are pressed when this system is in the standby mode or another input source is selected.

To change the disc play mode

If necessary, change the disc play mode by pressing **MODE** on the remote control.

- Single disc play mode:** Only the designated disc is played.
- All disc play mode:** All discs on the disc tray are played sequentially.

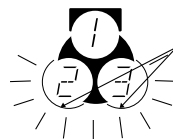

Lights up only when the all disc play mode is selected.

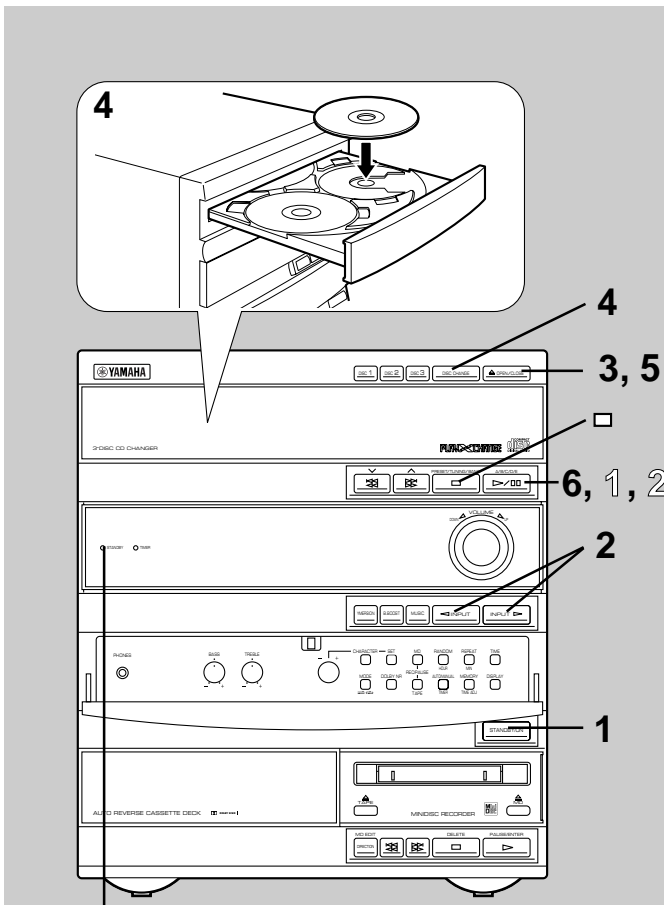

STANDBY indicator

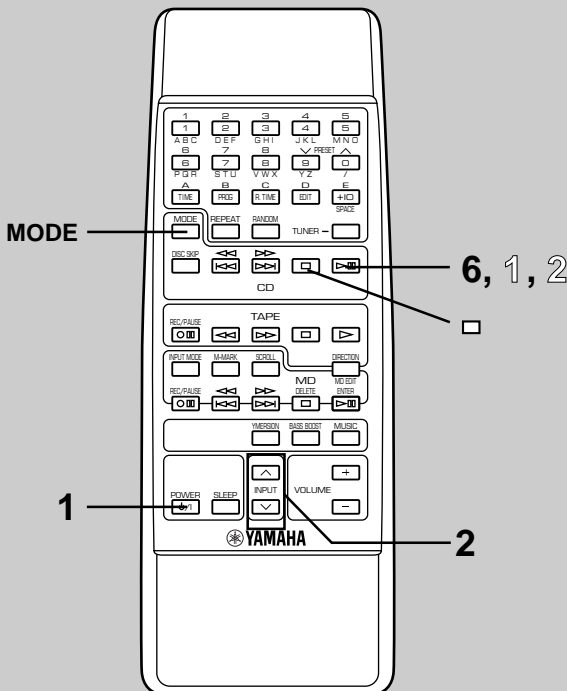



Compact disc player operation

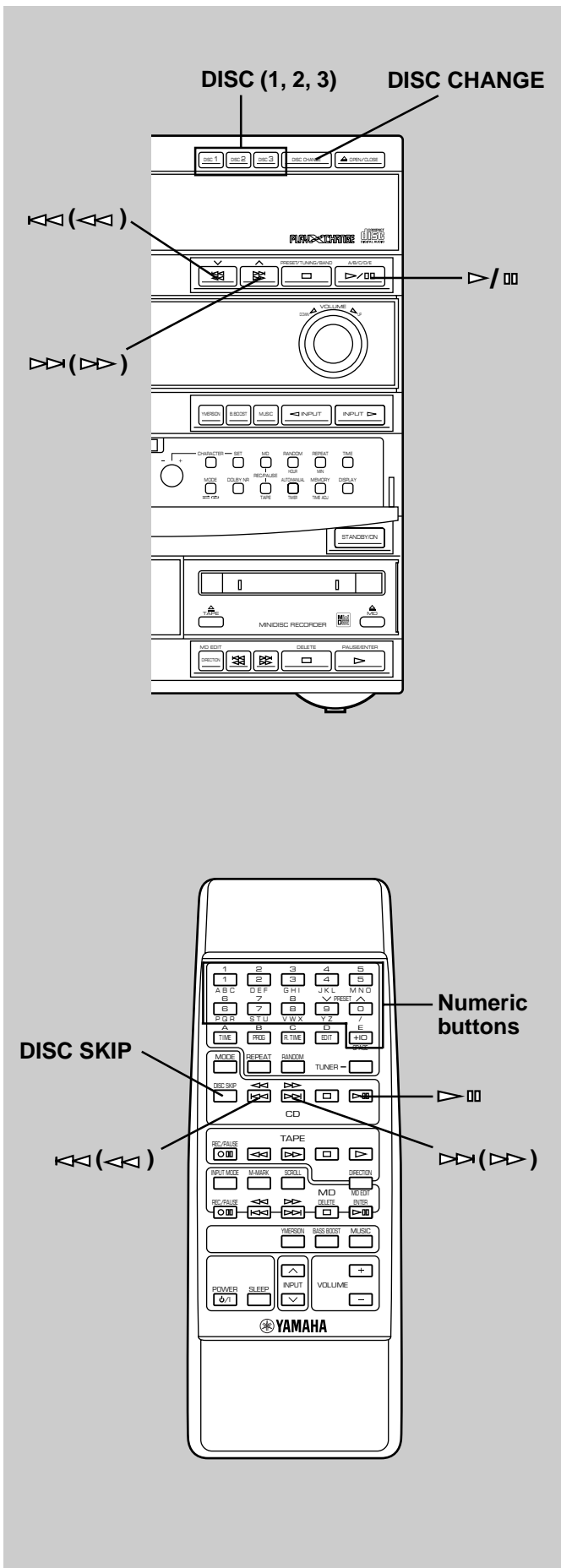

To select another disc

Press **DISC SKIP** on the remote control once or more (so that the corresponding disc number is located on the top of the disc indicator (③)).

Pressing **DISC (1, 2 or 3)** will select the disc directly, and play will begin from track 1 automatically.

To select the desired track directly

By using the numeric buttons on the remote control, any track you wish to listen to can be played directly.

Use the numeric buttons to select the desired track number. Play will begin automatically.

A. For example, to choose track 5
Press 5.

B. For example, to choose track 12
(1) Press **+10**.
(2) Within a few seconds, press 2.

C. For example, to choose track 20
(1) Press **+10**.
(2) Within a few seconds, press **+10** again.
(3) Within a few seconds, press 0.

Note

If you select a track number higher than the number of tracks on the disc, only the last track of the disc may be played.

To play the desired track (Skip)

Press **▷▷** to skip forward or **◀◀** to skip backward. Press once for each track to be skipped.

Note

This function can also be performed while the CD player is stopped. Press **▷/00** when the desired track number appears on the track number display. Play will begin from the beginning of the track.

To advance or reverse play rapidly (Search)

Press and hold **▷▷** to advance play rapidly, and **◀◀** to reverse play rapidly.

To exchange a disc (or discs) while playing (PLAYXCHANGE)

During play, you can open the disc tray by pressing **DISC CHANGE** without interrupting play. However, in this case, pressing **DISC SKIP** or **DISC (1, 2 or 3)** is invalid.



Program play

You can program up to 20 tracks in any desired order.

1 When the CD player is stopped, press **PROG** to prepare for programming.

* "PROG" (⑨) and "P-01" (②) will light up on the display, and all track numbers on the selected disc (⑦) will begin flashing.

2 If necessary, select the desired disc by pressing **DISC SKIP**.

* Just after you change the disc, the CD player reads the contents of the newly selected disc for a few seconds. During this internal operation, if you go on to the next step, "WAIT" (②) appears on the display and your operation is canceled.

3 Use the numeric buttons to select the desired track number.

* The selected track number (①) and the total play time of the programmed tracks (②) will light up on the display, and soon it will be replaced by the display of the next play order (②). Programmed track numbers on the selected disc will stop flashing and light up on the music calendar (⑦).

* Pressing **TIME** displays the total play time of the programmed tracks (②) for about 1 second, and then it is replaced by the display of the next play order (②).

4 Repeat steps 2 and 3 to program other tracks.

5 Press **▶/00** to start the program play.

Notes

- The total time of the programmed tracks will not be displayed, if track number 16 or higher is programmed.
- Skip (◀◀/ ▶▶) can be performed during play, but only within the range of the programmed tracks.
- Search (◀◀/ ▶▶) can be performed during play to search all tracks, including unprogrammed tracks.

To cancel a programmed sequence

There are several methods as described below.

- Press **□** while the CD player is stopped.
- Open the disc tray.
- Turn this system into the standby mode.

To check (and correct) program data

1. Press **PROG** when the CD player is stopped.
2. Every time **▶▶** is pressed, the track numbers and sequential order of the programmed tracks can be checked one after another. The display of the track number can be returned (sequentially in reverse order) by pressing **◀◀**.
3. If you want to correct the program data, press a numeric button to select the track to replace the one displayed. The previously programmed track will be cleared from the memory and the new one will be programmed. To complete the correction, press **PROG** or **▶/00** once again.

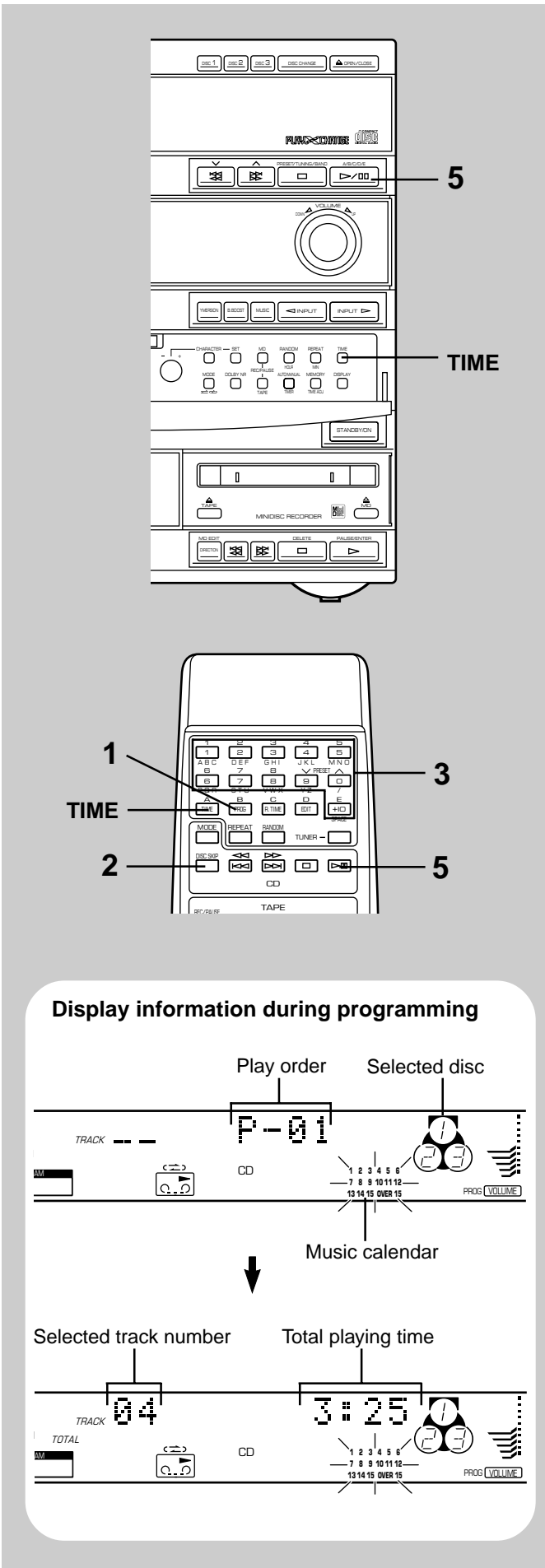



Compact disc player operation

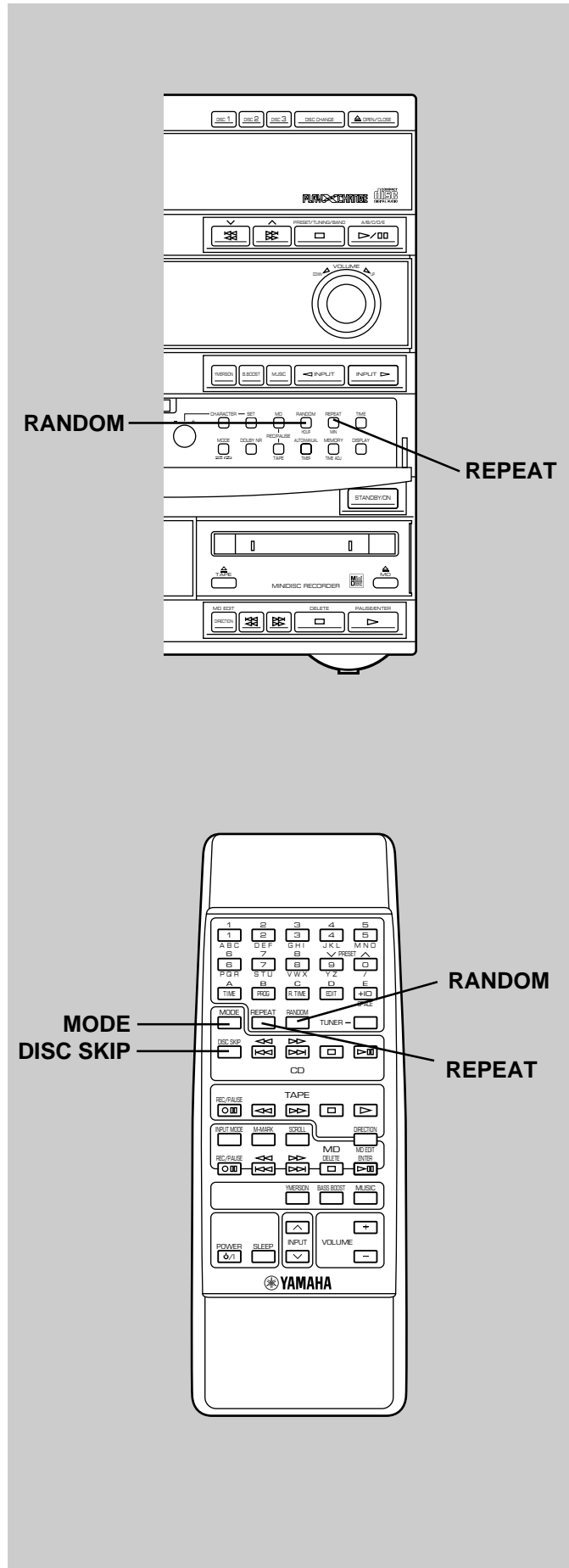

Random play

Tracks on a selected disc or all discs on the disc tray can be played randomly.

- 1 If necessary, switch the disc play mode by pressing **MODE**.
 - * If the single disc play mode is selected, select the desired disc by pressing **DISC SKIP**.

- 2 Press **RANDOM** to begin random play.
 - * The "RANDOM" indicator (⑥) will light up.

To cancel the random play

Press **□**, or press **RANDOM** so that the "RANDOM" indicator (⑥) will go out.

Note

This feature will not function during programming or program play.

Repeat play

All discs, a disc, a single track or a programmed sequence can be continuously repeated.

Press **REPEAT** once or more to select the desired repeat play mode so that the S REP or F REP indicator (⑩) is illuminated.

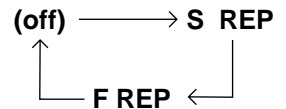

Repeat play modes

SINGLE REPEAT (S REP)

A single track is played repeatedly.

- * This is also available in the program play mode and the random play mode. (If the repeat play mode is switched off, the program play mode or the random play mode will be resumed.)

FULL REPEAT (F REP)

When the CD player is in the single disc play mode:

The designated disc is played repeatedly.

- * In the random play mode, the selected disc is repeatedly played, but the order of tracks is different every time.

When the CD player is in the all disc play mode:

All discs on the disc tray are played repeatedly.

- * In the random play mode, the random play is performed among all discs and repeated with a different order of tracks every time.

Note

In the program play mode, a sequence of programmed tracks is played repeatedly.

To cancel the repeat play

Press **REPEAT** once or more so that the (S, F) REP indicator (⑩) goes out.



Switching the time display

Every time **TIME** is pressed, the display will change as described below.

[Example]

When the second track is being played. (Refer to the illustration on the left.)

- 1 The elapsed play time for the current track will be displayed.
- 2 The remaining play time for the current track will be displayed.
- 3 The total play time of the disc will be displayed.
- 4 The total remaining play time of the disc will be displayed.

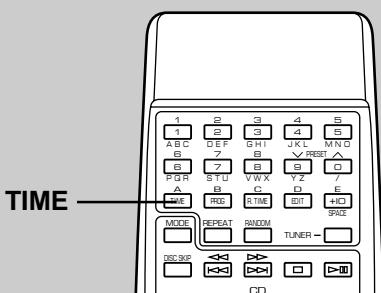
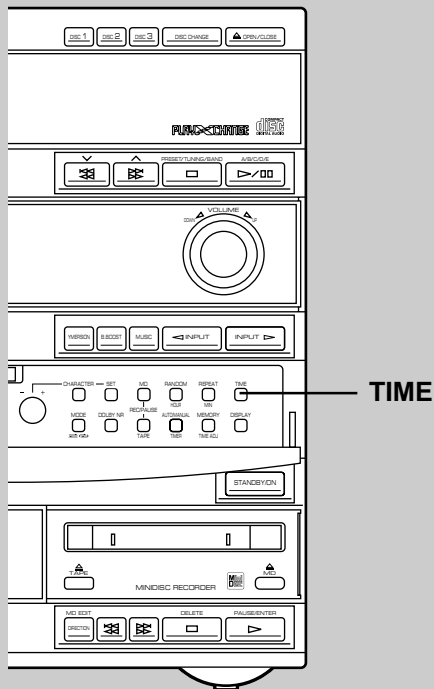
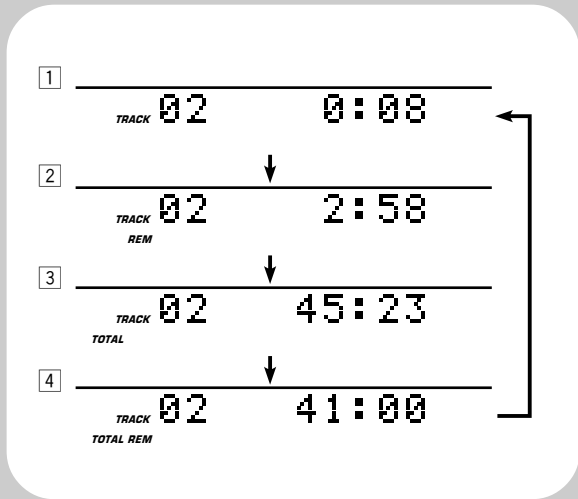

Tuning operation

Display information

Each indicator mentioned with a number on pages 15–17 corresponds to the indicator with the same number on this page.

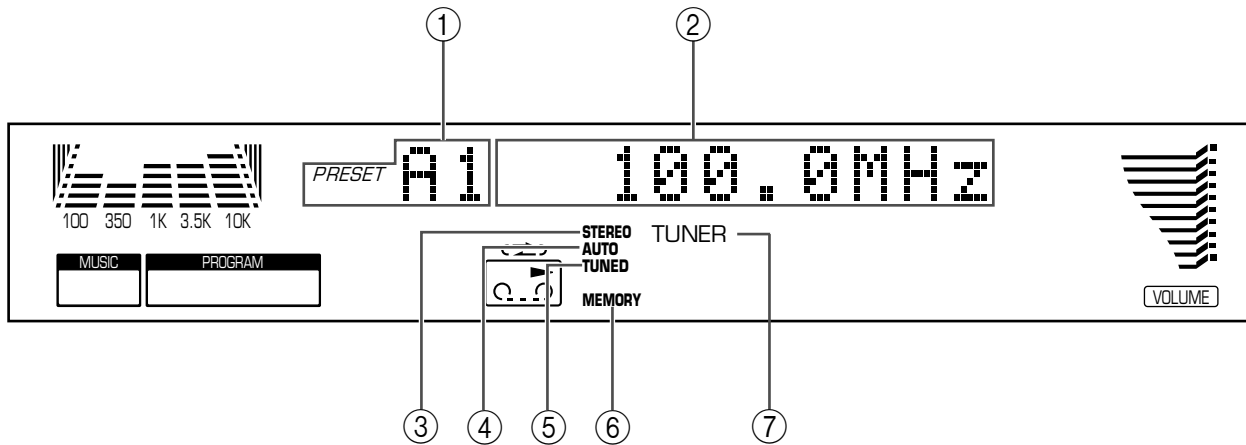

① Preset station group and number indicator

② Multi-information display

③ STEREO

④ AUTO

⑤ TUNED

⑥ MEMORY

⑦ TUNER (input source indicator)



Automatic tuning

- 1 Turn on the power.
- 2 Press **INPUT** \triangleright or \triangleleft until "TUNER" (②, ⑦) appears on the display, or simply press **TUNER** on the remote control.
- 3 Select the reception band (FM or AM) by pressing **PRESET/TUNING/BAND** confirming it on the display (②).
 - * Do not select the preset tuning mode (in which "PRESET" (①) lights up on the display).
- 4 Press **AUTO/MANUAL** so that "AUTO" (④) lights up on the display.
- 5 Press \wedge to tune to a higher frequency, or press \vee to tune to a lower frequency. (When tuned in to a station, "TUNED" (⑤) will light up on the display.)
- 6 If the station where tuning search stopped is not the desired one, follow step 5 again.
 - * If the tuning search does not stop at the desired station, change to the Manual tuning method as described below.
 - * "STEREO" (③) will light up when an FM stereo broadcast with sufficient signal strength is received.

Direct operation

TUNER on the remote control will work if it is pressed when this system is in the standby mode or another input source is selected.

Manual tuning

- 1 Follow steps 1 to 3 of the Automatic tuning method.
- 2 Press **AUTO/MANUAL** so that "AUTO" (④) disappears from the display.
- 3 Press and hold \wedge to tune to a higher frequency, or press and hold \vee to tune to a lower frequency. Release it just before reaching the desired frequency, and then press it repeatedly until the desired frequency appears. (When tuned in to a station, "TUNED" (⑤) will light up on the display.)

Note

If you tune in to an FM station manually, it is received in monaural to increase the signal quality.

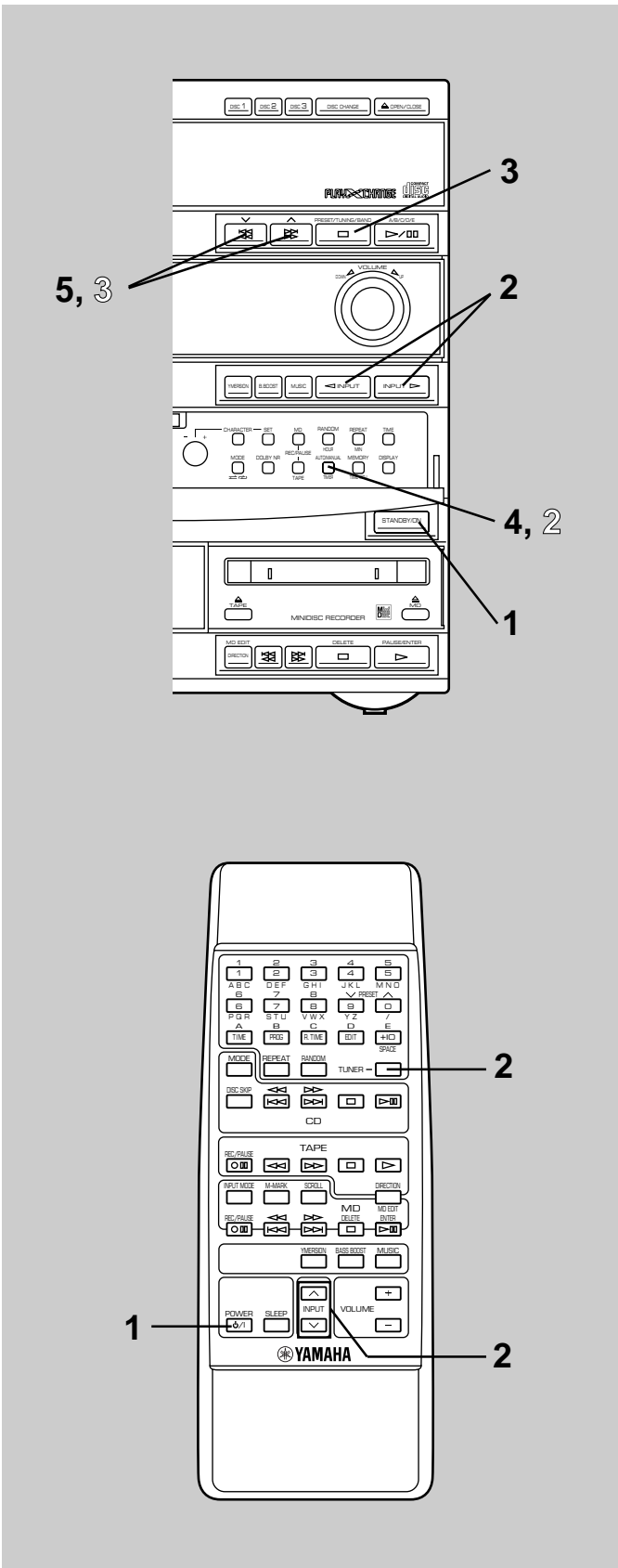



Tuning operation

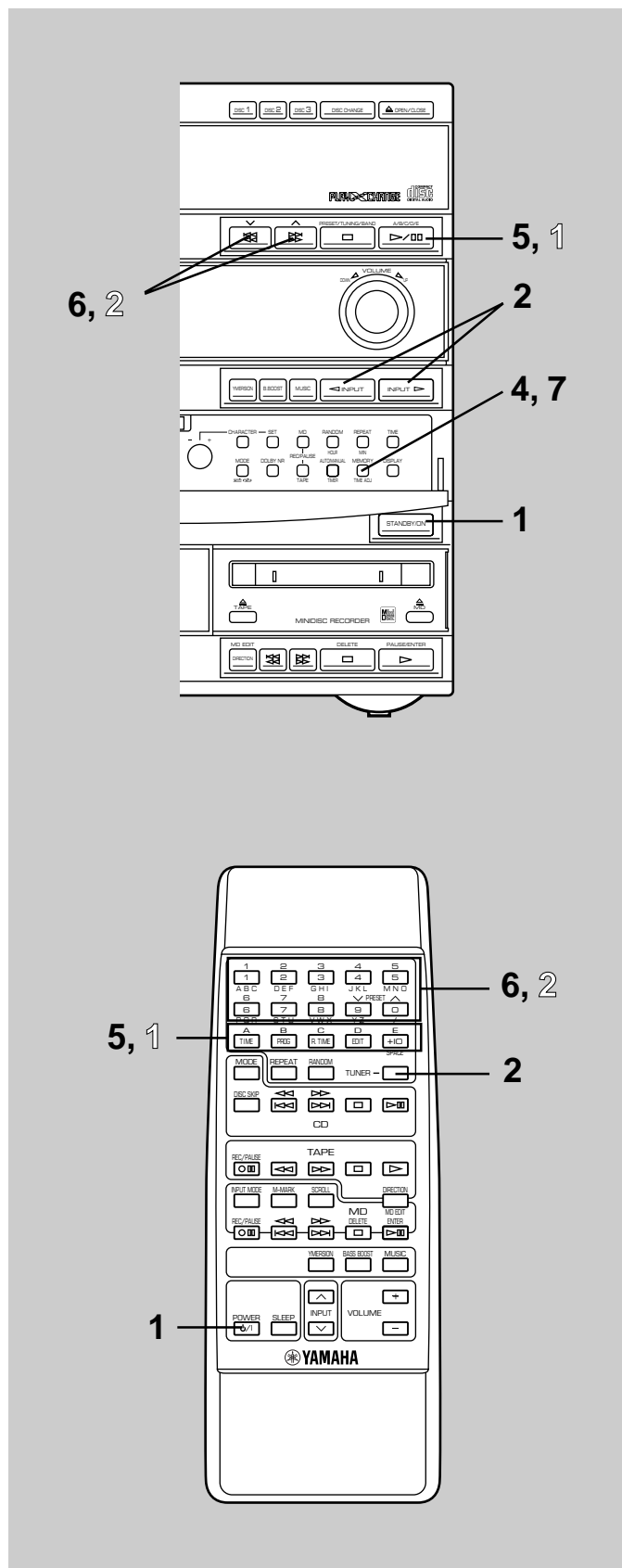

Manual preset tuning

The built-in tuner can store station frequencies selected by tuning operation. With this function, you can select any desired station only by calling the corresponding preset station number. Up to 40 stations (8 stations x 5 groups) can be stored.

■ To store stations

- 1 Turn on the power.
- 2 Press **INPUT** \triangleright or \triangleleft until "TUNER" (②, ⑦) appears on the display, or simply press **TUNER** on the remote control.
- 3 Tune in to the desired station.
- 4 Press **MEMORY**.
 - * "MEMORY" (⑥) and "PRESET" (①) will flash on the display for about 5 seconds.
- 5 Select the desired group (A – E) of preset stations by pressing **A/B/C/D/E** confirming it on the display, before "MEMORY" (⑥) goes out.
- 6 Select a preset station number by pressing \vee or \wedge repeatedly or pressing a numeric button (1 to 8) before "MEMORY" (⑥) goes out.
- 7 Within about 5 seconds, press **MEMORY** again.

■ To recall a preset station

- 1 Select a group of preset stations by pressing **A/B/C/D/E**.
- 2 Select the desired preset station number by pressing \vee or \wedge repeatedly or pressing a numeric button (1 to 8).

Notes

- A new setting can be programmed in place of the former one.
- For presets the setting of **AUTO/MANUAL** is stored along with the station frequency.



Automatic preset tuning

You can make use of an automatic preset tuning function. With this function, the built-in tuner performs automatic tuning. Up to 40 stations are stored automatically.

- 1 Turn on the power.
- 2 Press **INPUT** \triangleright or \triangleleft until "TUNER" (②, ⑦) appears on the display, or simply press **TUNER** on the remote control.
- 3 Press and hold **MEMORY** for more than 2 seconds.
* The "MEMORY" (⑥) and "AUTO" (④) indicators flash.

The tuner performs automatic tuning and searches FM and AM stations in that order. Received stations are programmed to A1, A2 ... A8 sequentially.

When the automatic preset tuning is completed;

The display shows the frequencies of the first preset station (stored to A1).

If you want to check the contents and the number of preset stations, follow the procedure of the section "To recall a preset station" on the previous page.

To recall a preset station

Simply follow the procedure of the section "To recall a preset station" on the previous page.

Notes

- The automatic preset tuning search will be performed through all frequencies until 40 stations are stored. If the number of received stations is less than 40, the search will stop after searching all frequencies.
* Since FM stations are searched for first, there may be a case that 40 preset stations are occupied by FM stations only.
- With this function, only stations with sufficient signal strength are stored automatically. If the station you want to program is weak in signal strength, tune in to it with the Manual tuning method (in monaural) and program it by following the procedure of the section "To store stations" on the previous page.
- You can replace a preset station with another FM or AM station manually by simply following the procedure of the section "To store stations" on the previous page.

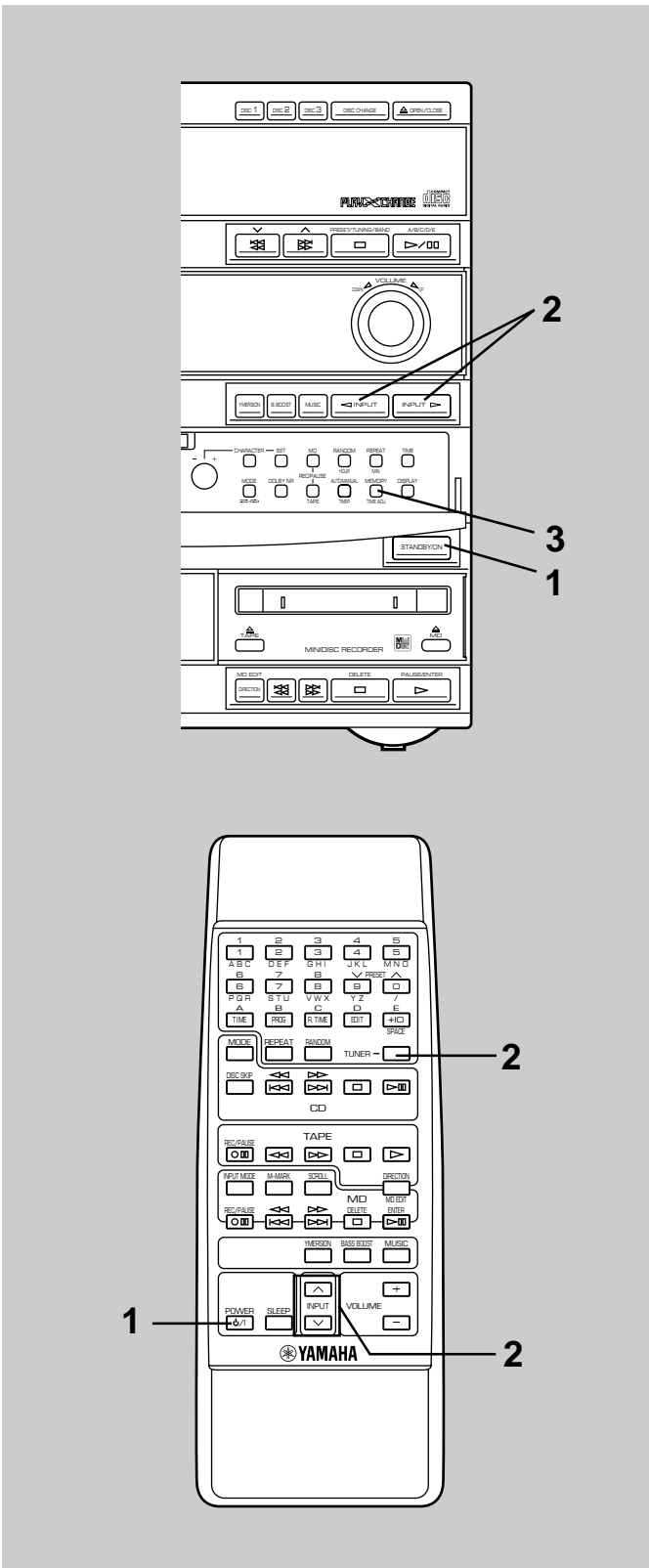

Memory back-up

The memory back-up circuit prevents the programmed data from being lost even if the AC supply lead is disconnected from the AC outlet or the power is cut due to temporary power failure. If, however, the power is cut for more than one week, the memory may be erased. If so, it can be re-programmed by simply following the Preset tuning steps.

Playing back a tape

Display information

Each indicator mentioned with a number on pages 19–25 corresponds to the indicator with the same number on this page.

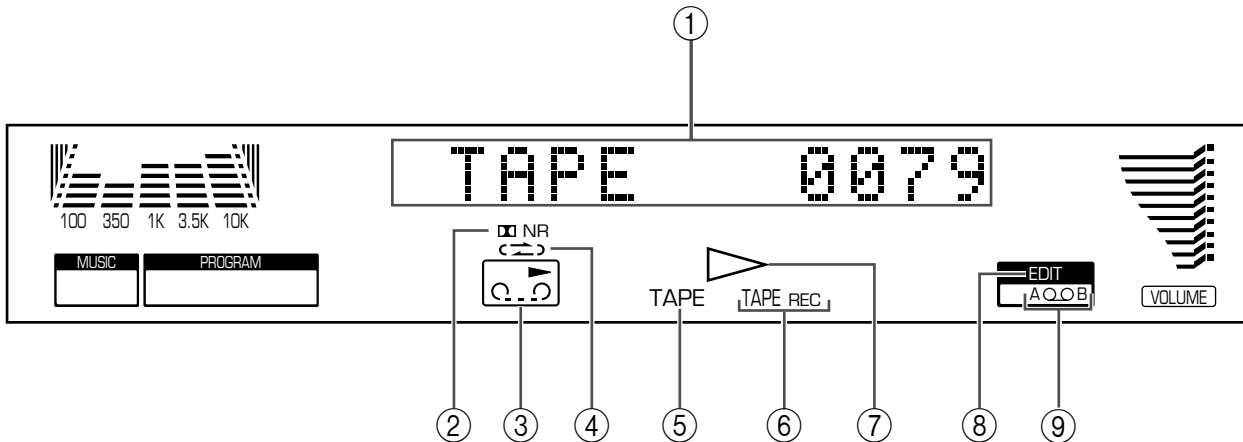

- ① Tape counter
- ② NR (DOLBY NR)
- ③ Tape direction indicator
- ④ Reverse mode indicator
- ⑤ TAPE (input source indicator)
- ⑥ TAPE REC
- ⑦ ▷ (play)
- ⑧ EDIT
- ⑨ Tape side indicator

General information

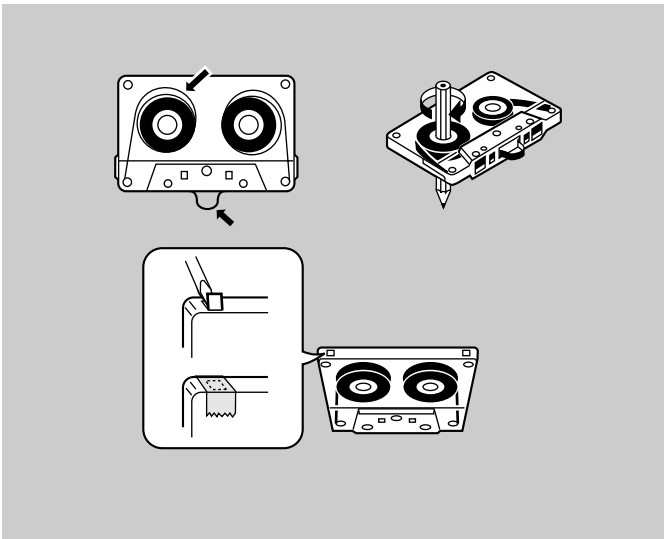

- Do not use C-120 tapes or poor-quality tapes, since they can cause malfunctions.
- Before loading a tape on the tray, tighten the tape slack with a pen or pencil.
- Tapes have removable tabs which prevent accidental recording or erasing from taking place. Removing the tab on the top left protects the side facing you from erasure. Cover the tab holes with adhesive tape to erase or record again.
- The tape deck features an automatic tape selector. Just load the tape, and the tape formula being used will be sensed automatically.
- The tape deck can play back metal tapes as well as normal or chrome tapes, however recording cannot be done on metal tapes with good sound quality.

Dolby B Type Noise Reduction

Dolby noise reduction is an extremely effective method of reducing undesirable background hiss on tapes. The built-in tape deck incorporates Dolby B type noise reduction system. **DOLBY NR** is useful to both recording and playback; be sure that the same noise reduction is used on recording and playback.

Dolby noise reduction manufactured under license from Dolby Laboratories Licensing Corporation. "DOLBY" and the double-D symbol are trademarks of Dolby Laboratories Licensing Corporation.

About the tape counter

The tape deck is equipped with a tape counter that is useful for searching and locating a desired point on the tape. The tape counter is shown on the display. Pressing (stop) when the deck is stopped will reset the tape counter to "0000".





Basic operation

- 1 Turn on the power.
- 2 Press **INPUT** ▷ or ◁ until "TAPE" (①, ⑤) appears on the display.
- 3 Open the tray by pressing ▲.
- 4 Load the tape on the tray with side A upward, and close the tray by pressing ▲ or pushing the front edge of the tray gently.
- 5 Press **MODE** or **DIRECTION** to change the current setting if necessary.

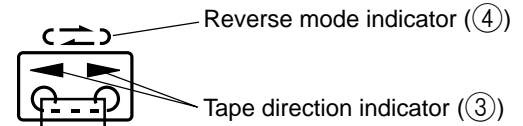
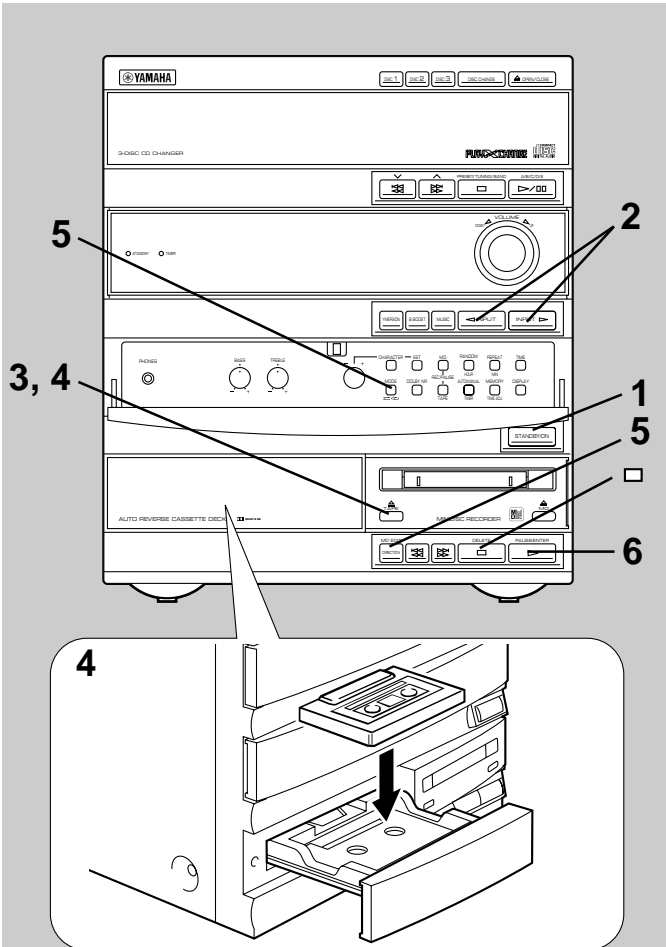

Moves slowly in the current tape running direction during playback.

MODE \ DIRECTION	▶	▶↪	↺↻
▶	Side A only	Side A → Side B	Side A → Side B ↑ (Repeats 8 times) Starts from side A.
◀	Side B only	Side B only	Side B → Side A ↑ (Repeats 8 times) Starts from side B. (Side A is not played at the first time.)

- 6 Press ▷.
Playback begins.

To stop playback
Press □.

To remove the tape
Open the tray by pressing ▲.

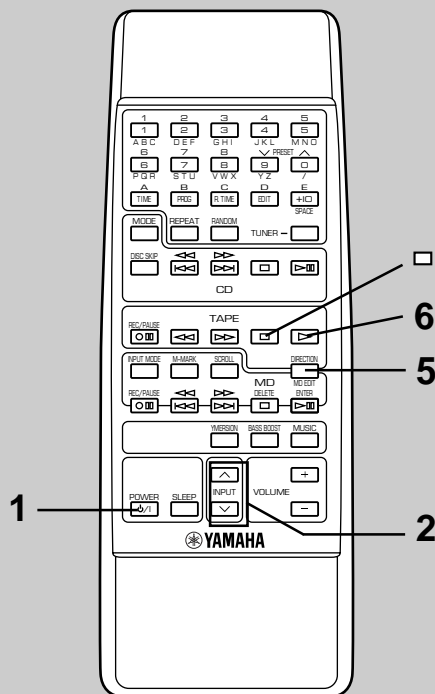

Direct operation

▷ on the remote control or ▲ will work if either is pressed when this system is in the standby mode.



Playing back a tape

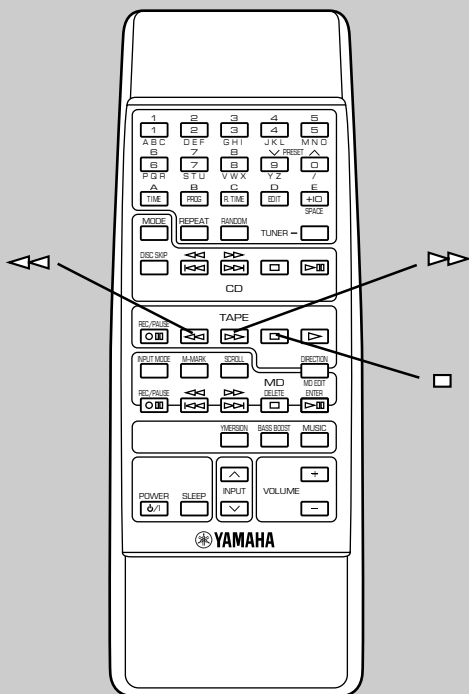
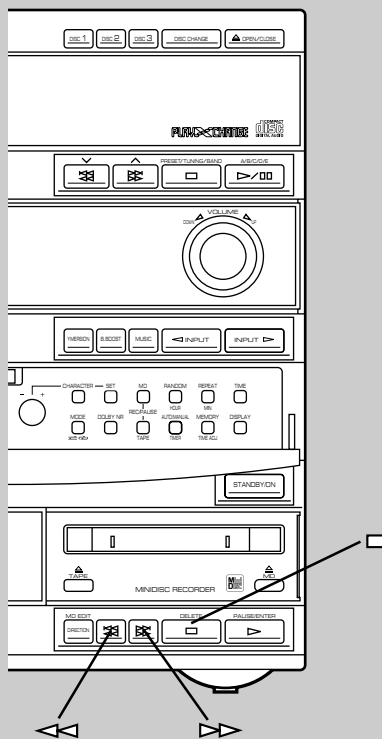

Winding the tape

1 Press ◀◀ or ▶▶ to wind the tape.

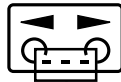

Moves rapidly in the current tape running direction while winding.

2 Press □ to stop.

Note

When the tape is wound to the end, the tape deck will then function as described below.

◀◀ : The tape stops at the end.

▶▶ : If the winding direction is ▶, when the tape reaches the end, playback automatically starts from the reverse side.
If the winding direction is ◀, the tape stops at the end.

◀▶▶ : When the tape reaches the end, playback automatically starts from the reverse side.

Searching for the beginning of the desired selection

Press ◀◀ or ▶▶ during playback.

To listen to the same selection

Press ◀◀ if the direction of the current playback is ▶.
Press ▶▶ if the direction of the current playback is ◀.

To listen to the next selection

Press ▶▶ if the direction of the current playback is ▶.
Press ◀◀ if the direction of the current playback is ◀.

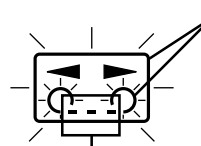

Flashes on and off.

Moves rapidly in the current tape running direction while searching.

Notes

- This function may not work for tapes with
 - * Material with long pauses or quiet passages.
 - * Low recording levels or excessive noise.
 - * Pauses of less than 4 seconds between selections.
- If searching is carried out at the first or the last part of a selection, the desired selection may not be found.



Recording to tape

Notes

- Adjusting the **VOLUME**, **BASS** and **TREBLE** controls, **YMERSSION**, **B. BOOST** and **MUSIC** buttons have no effect on the recorded sound. The recording level is automatically adjusted.
- If you want to make a recording using Dolby NR, press **DOLBY NR** so that “**NR**” (②) lights up on the display. If not, turn “**NR**” (②) off.
 - * For details, refer to “Dolby B Type Noise Reduction” on page 18.

Basic recording

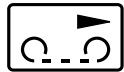
- 1 Turn on the power.
- 2 Press **INPUT** \triangleright or \triangleleft once or more to select the source you want to record.
- 3 Load a tape on the tray with side A upward.
- 4 Press **DIRECTION** or **MODE** to change the current setting if necessary.

	MODE	
DIRECTION	\rightleftarrows	\rightleftarrows
	Side A only	Side A → Side B
	Side B only	Side B only

- 5 Press **TAPE REC/PAUSE**.
 - * “**TAPE REC**” (⑥) lights up on the display.
- 6 Begin playing the source to be recorded.
 - * When playing a CD or MD, the recording automatically begins a few seconds before the CD or MD play begins. You do not need to follow step 7.
- 7 Press \triangleright of the tape deck.

Displaying the tape counter

During recording, the information of the playing source is displayed in place of the tape counter (①). Press **DISPLAY** to change the display to the tape counter. Pressing **DISPLAY** again will restore the previous display mode.

Recording to both tape and MD

You can record a source to a tape and MD at the same time by pressing both **TAPE** and **MD REC/PAUSE** in step 5 (except using the EDIT function).

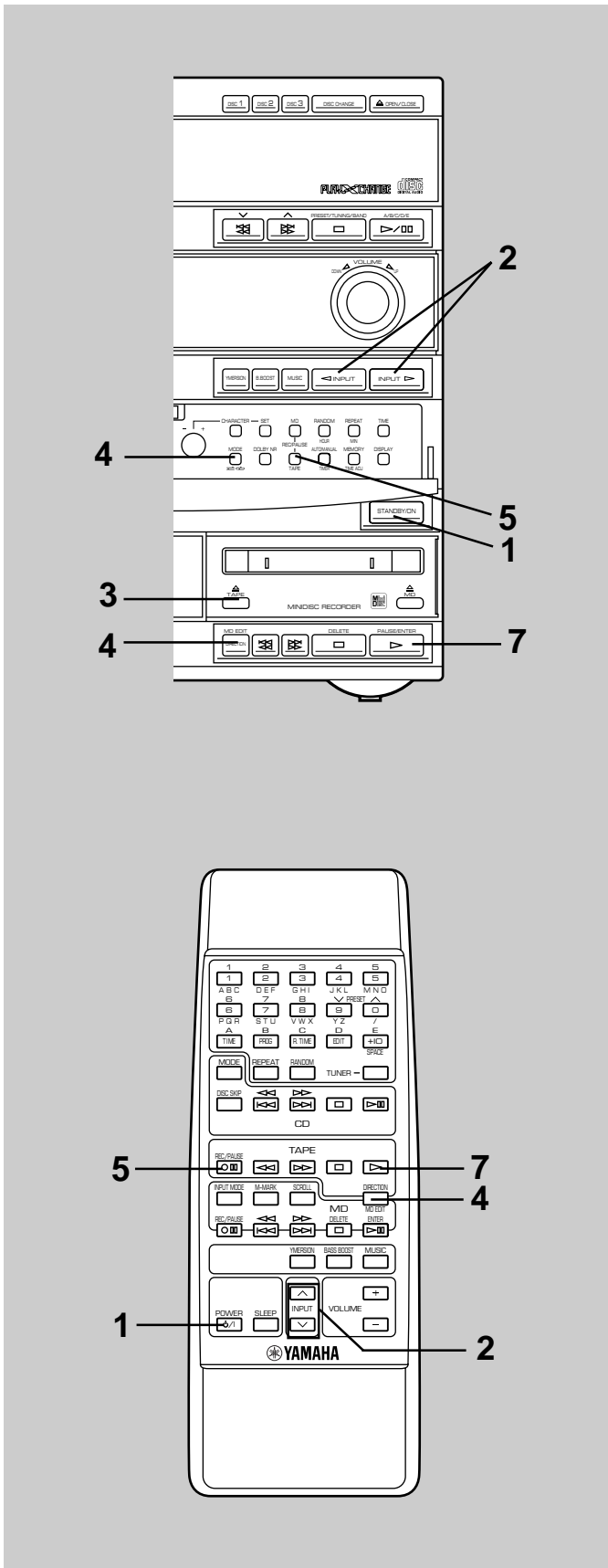



Recording to tape

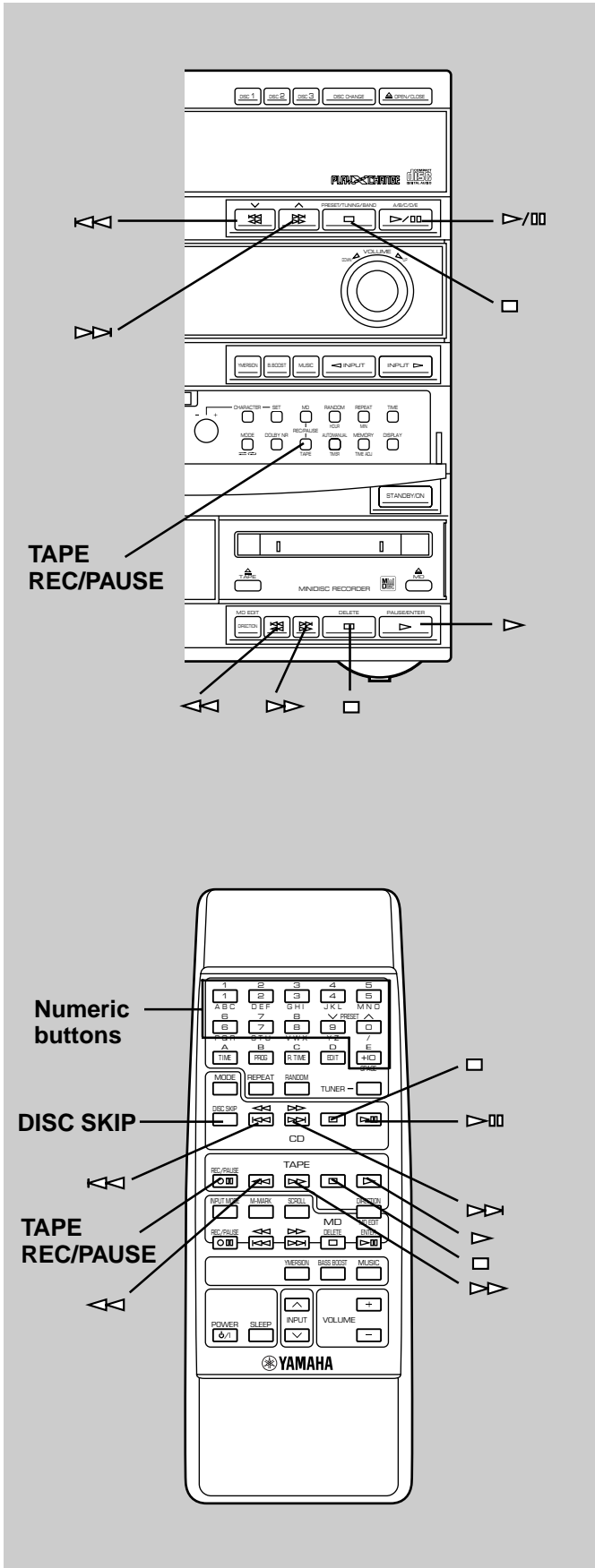

To stop recording temporarily

Press **TAPE REC/PAUSE**.

* Press ▷ of the tape deck to resume recording.

To stop recording

Press □ of the tape deck.

To change the disc and track when recording from a CD

1 Press □ of the CD player.

* The recording stops temporarily.

2 Select the disc by pressing **DISC SKIP** if necessary.

3 Choose the track you want to record next by using ▷▷ or ◀◀, and then press ▷/□ of the CD player to resume recording (or simply press the corresponding numeric button(s) on the remote control).

To change the disc and track during recording from an MD

1 Press □ of the MD recorder.

* The recording stops temporarily.

2 Change the disc if necessary.

3 Choose the track you want to record next by using ▷▷ or ◀◀, and then press ▷ of the MD recorder to resume recording.

Notes

- A sequence of tracks in the program play mode and random play mode of the CD player or MD recorder can be recorded in the same way.
- During recording, by simply pressing ◀◀ or ▷▷, you can rewind the tape to the point where the recording started.



Recording from CDs utilizing the EDIT function

The EDIT function performs recording on both sides of the tape.

EDIT recording

- 1 Press **INPUT** \triangleright or \triangleleft once or more until "CD" (①, ⑤) appears on the display, and load the disc to be recorded.
- 2 Select the disc by pressing **DISC SKIP**.
- 3 Load a tape on the tray with side A upward.
- 4 Select "↔" (④) by pressing **MODE**, and "▶" (③) by pressing **DIRECTION**.
- 5 Press **TAPE REC/PAUSE**.
- 6 Press **R. TIME** on the remote control to select the length of the tape to be used. Whenever pressed, the display changes as shown below.

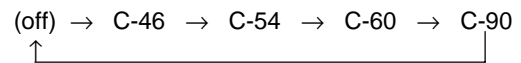

When using tapes other than C-46, C-54, C-60 or C-90
After pressing **R. TIME**, input the tape length by using the numeric buttons on the remote control.

- 7 Press **EDIT**. ("EDIT" (⑧) lights up on the display.)

The following operations are carried out automatically.

- 1) Tracks on the disc are automatically divided into side A and side B. You can check the process by watching the display.
 - * The tape side indicator (⑨) shows the side currently selected.
- 2) If the tape is not rewound to the end, it will rewind to the end rapidly.
- 3) The end part of the tape on which recording cannot be done is wound.
- 4) Both CD play and recording starts. Recording is carried out on both sides of the tape continuously.

Notes

- When the CD player is in the all disc play mode, if the tape's total possible recording time is longer than the total playing time of the selected disc, tracks on another disc are recorded continuously. In this case, as many as three discs can be recorded automatically.
- The CD player's repeat play mode will be canceled during this recording mode.

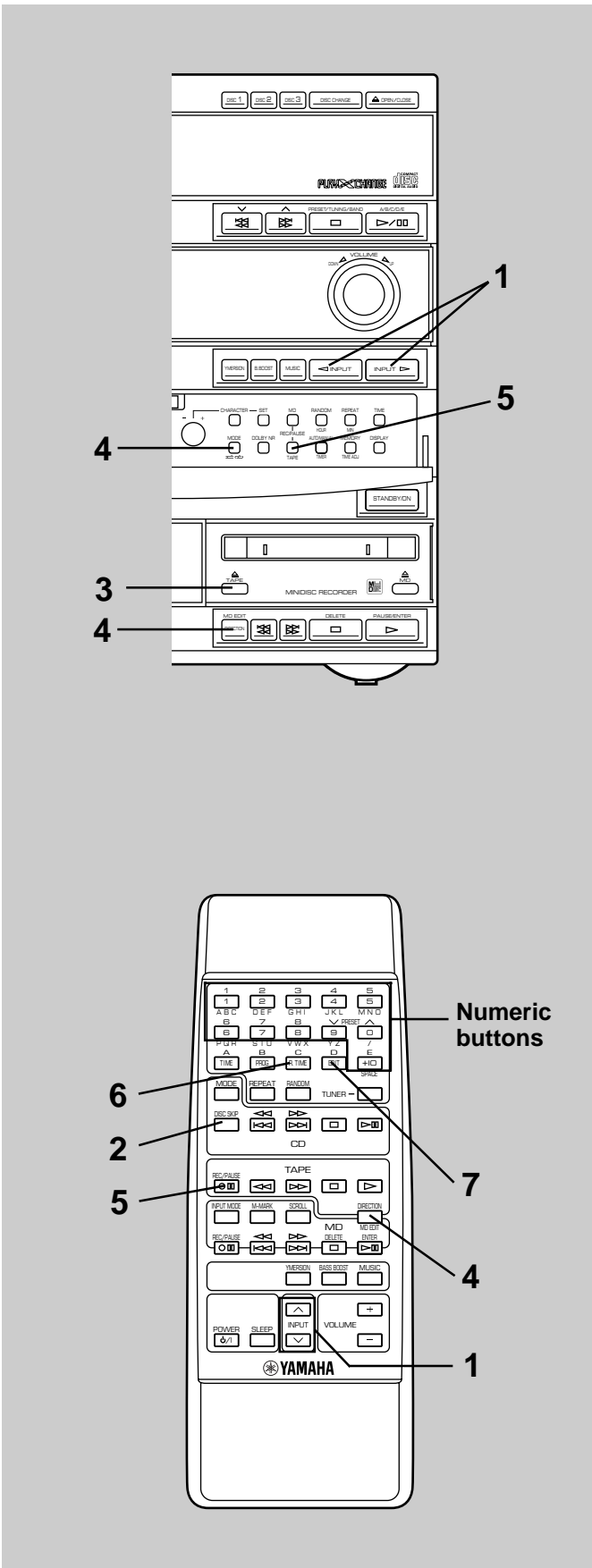



Recording to tape

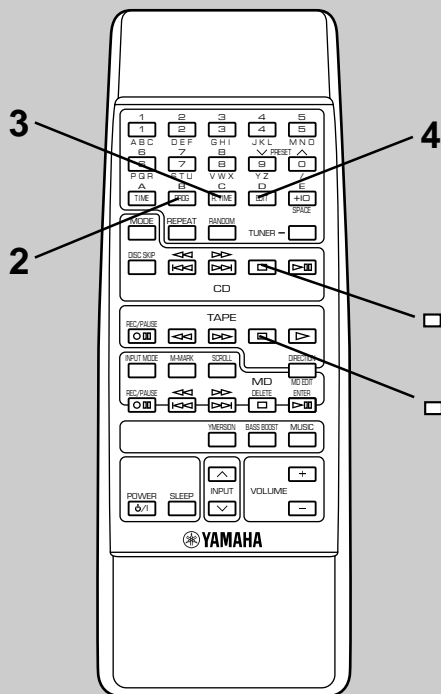
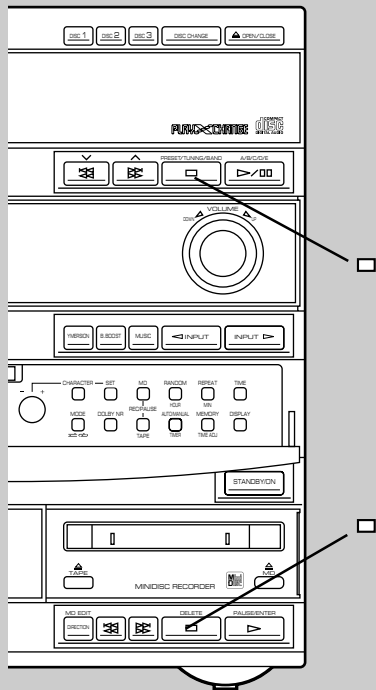

■ Auto-EDIT recording

This recording automatically changes the order of tracks so that the unrecorded space of side A is minimized.

- 1 Follow steps 1–6 on the previous page.
- 2 Press **PROG**.
- 3 Press **R. TIME**.
“Auto A >>>” will light up during programming for side A, and “Auto B >>>” will light up during programming for side B.
- 4 Press **EDIT**. (“EDIT” (⑧) lights up on the display.)
The recording starts.

To cancel the EDIT function

Before recording, press □ of the CD player or the tape deck.

To stop recording

Press □ of the tape deck.

(At this time, CD play automatically stops.)



Manual EDIT recording

You can program tracks manually while watching the remaining time on both sides of the tape.

- 1 Press **INPUT** \triangleright or \triangleleft once or more until "CD" (①, ⑤) appears on the display, and load a disc (or discs) on the disc tray.
- 2 Follow steps 3–6 on page 23.
- 3 Press **PROG**.
 - * "PROG" and "P-01" will light up on the display, and all track numbers on the selected disc will begin flashing.
- 4 If necessary, select the desired disc by pressing **DISC SKIP**.
- 5 Select the desired track number by pressing the numeric buttons.
- 6 Repeat steps 4 and 5 to program more selections for side A of the tape. You can select the same track again.
 - * Pressing **TIME** displays the total remaining time on side A of the tape for about 1 second, and then it is replaced by the display of the next play order.
 - * If "TM OVER" appears on the display, the track number just selected cannot be programmed because there is not enough time remaining on side A of the tape. However, at this time, if any other track number is flashing continuously on the display, you can program it instead of the unprogrammable one.
- 7 When the programming for side A is finished, press **R. TIME**.
 - * "Side-B" appears on the display. You can begin programming for side B.
 - * After following this step, you can check the programmed contents for side A and side B alternately by pressing **R. TIME** at any time before you press **EDIT** in step 9.
 - * The tape side indicator (⑨) shows the programming side currently selected.
- 8 Repeat steps 4 and 5 to program selections for side B of the tape. You can select the same track again.
- 9 Press **EDIT**. ("EDIT" (⑧) lights up on the display.) The recording starts.

Notes on recording with the EDIT function

- To check, cancel or correct program data, refer to page 11.
- The maximum number of tracks that can be programmed is 20.
- The track number 16 or higher cannot be programmed by this function.

Display information during programming

	Next play order	Selected disc	
TRACK	P-01	1	
NR	CD	1 2 3 4 5 6	
CD		7 8 9 10 11 12	
		13 14 15 OVER 16	
		A.Q.O. PROG VOLUME	
		Side of the tape	

↓

Selected track number	Total remaining time on this side of the tape		
04	19:55	1	
REM		1 2 3 4 5 6	
		7 8 9 10 11 12	
		13 14 15 OVER 16	
		A.Q.O. PROG VOLUME	

Programmed track numbers light up and only programmable track numbers among unprogrammed ones flash.

Playing an MD

Display information

Each indicator mentioned with a number on pages 27–38 corresponds to the indicator with the same number on this page.

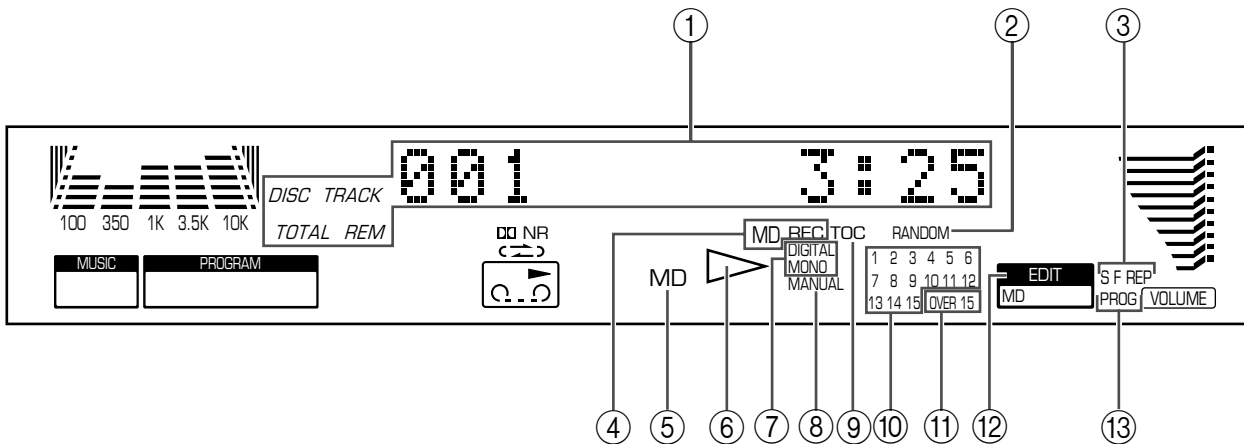

- ① Multi information display
- ② RANDOM
- ③ (S, F) REP [(single, full) repeat]
- ④ MD REC
- ⑤ MD (Input source indicator)
- ⑥ ▷ (play)
- ⑦ MONO, DIGITAL, DIGITAL MONO (Input mode indicator)
- ⑧ MANUAL
- ⑨ TOC (Table Of Contents)
- ⑩ Music calendar
Track numbers on the currently selected disc will be illuminated (up to the number 15).
- ⑪ OVER 15
This indicator will be illuminated when the currently selected disc has more than 15 tracks.
- ⑫ EDIT
- ⑬ PROG (program)

General information

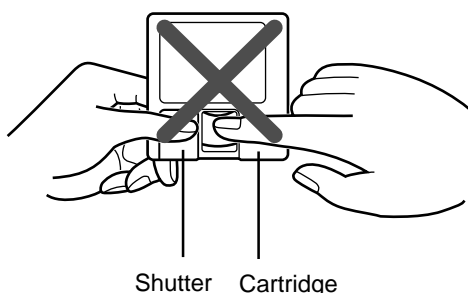
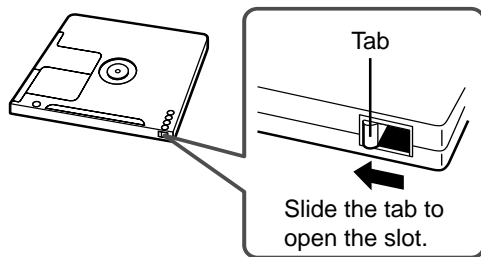

Protecting a recorded MD

- To protect a recorded MD, slide the tab on the side of the MD to open the slot.
In this position, the MD cannot be used for recording. To record on the MD, slide the tab to close the slot.
- If the MD is protected against erasure, "Protected" appears on the display.

Care of MDs

- Do not expose the MD to direct sunlight or heat sources such as hot air ducts, nor leave it in a car parked in direct sunlight as there can be a considerable rise in temperature inside the car.
- Periodically remove dust and debris from the cartridge surface by wiping it with a dry cloth.
- Because the MD itself is housed in a cartridge, you can handle it normally without being concerned about dirt or fingerprints. However, a malfunction may result if the cartridge itself is dirty or warped.
- Do not open the shutter to expose the MD.

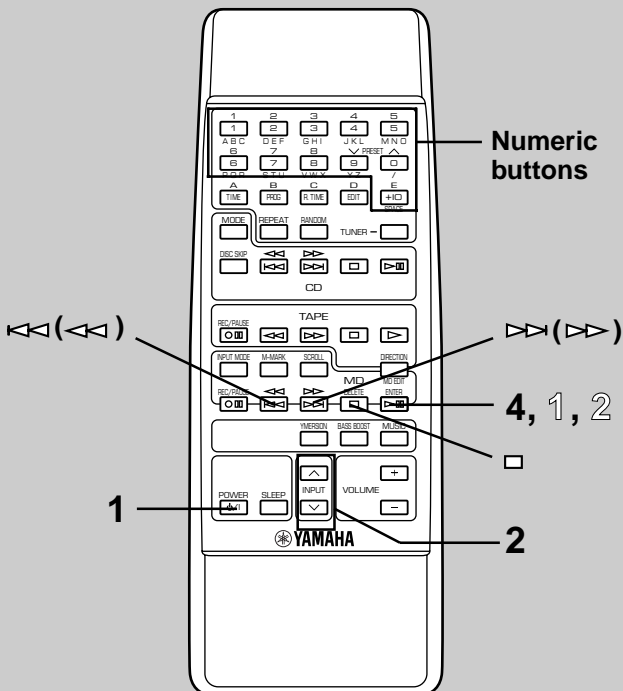
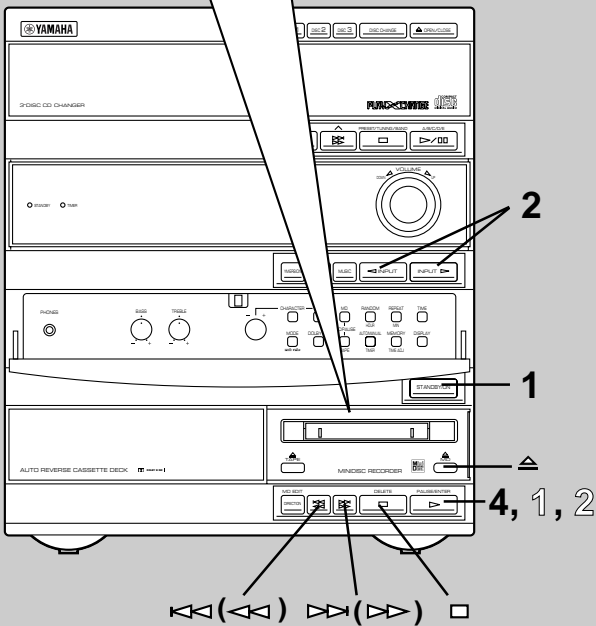
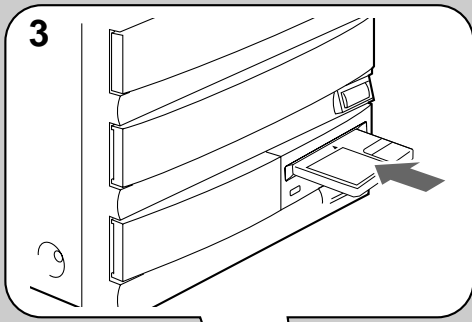

Basic play

- 1 Turn on the power.
- 2 Select the MD recorder by pressing **INPUT** \triangleright or \triangleleft until "MD" (①, ⑤) appears on the display.
- 3 Insert an MD into the disc insertion slot in the direction of the arrow printed on the MD.
 - * The disc title appears on the display, and then it is replaced by the total number of tracks and the total playing time of the disc (①).
 - * If the disc contains more than 15 tracks, the "OVER 15" indicator (⑪) will light up.
- 4 Press \triangleright (or \triangleright \square on the remote control) to begin play.

To pause

- 1 Press \triangleright (or \triangleright \square on the remote control).
 - * The "▷" indicator (⑥) will flash.
- 2 Press \triangleright (or \triangleright \square on the remote control) to resume play from the same point.

To stop play

Press \square .

To eject the MD

Press \triangle .

To select the desired track directly

By using the numeric buttons on the remote control, any track you wish to listen to can be played directly.

Use the numeric buttons to select the desired track number. Play will begin automatically.

For example, to choose track 23

- (1) Press **+10**.
- (2) Within a few seconds, press **+10** again.
- (3) Within a few seconds, press **3**.

To play the desired track (Skip)

Press \triangleright to skip forward or \triangleleft to skip backward. Press once for each track to be skipped.

Note

This function can also be performed while the MD recorder is stopped. Press \triangleright (or \triangleright \square on the remote control) when the desired track number appears on the track number display. Play will begin from the beginning of the track.

To advance or reverse play rapidly (Search)

Press and hold \triangleright to advance play rapidly, and \triangleleft to reverse play rapidly.



Playing an MD

Switching the display

Every time **TIME** is pressed, the display will change as described below.

During play

[Example]

When the second track is being played. (Refer to the illustration on the left.)

- 1 The elapsed play time for the current track will be displayed.
- 2 The remaining play time for the current track will be displayed.
- 3 The title of track currently played will be displayed. ("No Title" will appear if the track has no title.)

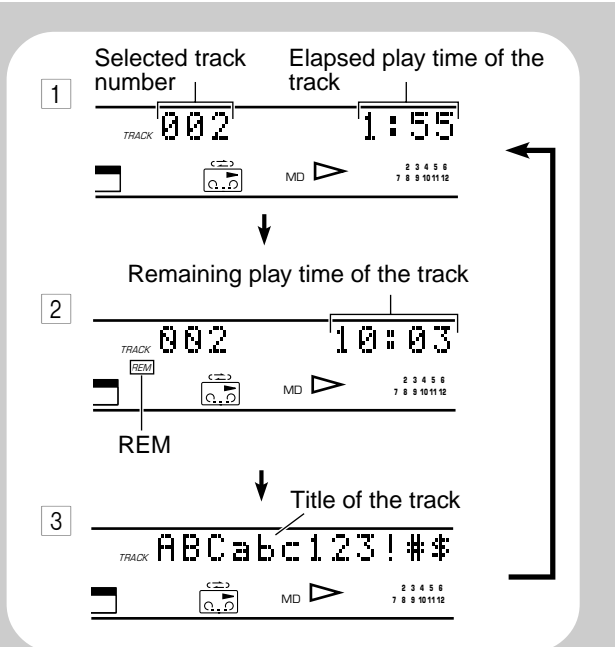

TIME SCROLL

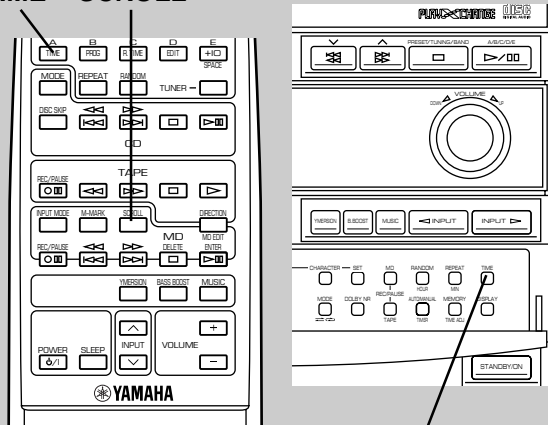

TIME

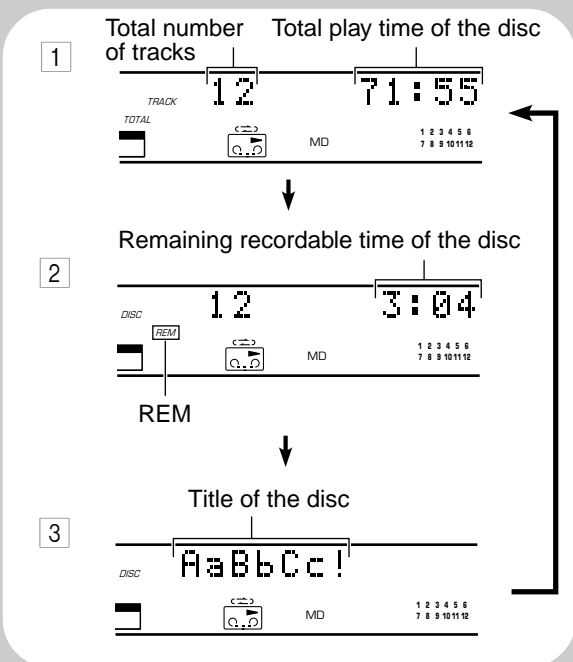

When stopped

- 1 The total number of tracks and the total play time of the disc will be displayed.
- 2 The total number of tracks and the remaining recordable time of the disc will be displayed (only for recordable discs).
- 3 The disc title will be displayed. ("No Title" will appear if the disc has no title.)

To view the entire disc (track) title

If the disc (track) title is too long to fit in the display, press **SCROLL**.

Press **SCROLL** while the title is scrolling to stop the scrolling.

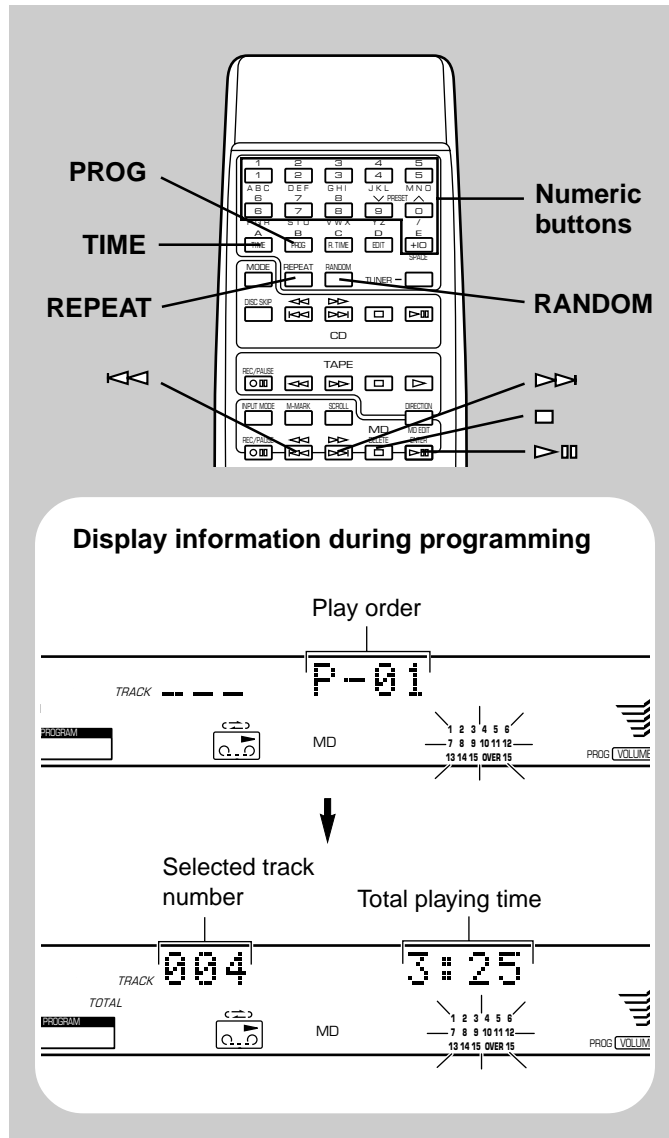

Repeat play

A disc, a single track or a programmed sequence can be continuously repeated.

Press **REPEAT** once or more to select the desired repeat play mode so that the S REP or F REP indicator (③) is illuminated.

Repeat play modes

SINGLE REPEAT (S REP)

A single track is played repeatedly.

FULL REPEAT (F REP)

The disc is played repeatedly.

To cancel the repeat play

Press **REPEAT** once or more so that the (S, F) REP indicator (③) goes out.



Program play

You can program up to 30 tracks in any desired order.

- When the MD recorder is stopped, press **PROG** to prepare for programming.
 - * "PROG" (⑬) and "P-01" (①) will light up on the display, and all track numbers on the disc (⑩) will begin flashing.
- Program the desired track number by using the numeric buttons.
 - * The selected track number and the total play time of the programmed tracks (①) will light up on the display, and soon it will be replaced by the display of the next play order. Programmed track numbers on the disc will stop flashing and light up on the music calendar (⑩).
 - * Pressing **TIME** displays the total play time of the programmed tracks (①) for about 1 second, and then it is replaced by the display of the next play order.
- Repeat step 2 to program more tracks. You can select the same track again.
- Press **▶** to start the program play.

Notes

- Skip (◀/▶) and search can be used during play, but only within the range of the programmed tracks.
- If the total time exceeds 255 minutes, "255mOver" is displayed instead of the total time.

To cancel a programmed sequence

There are several methods as described below.

- Press **□** while the MD recorder is stopped.
- Eject the MD.
- Turn this system into the standby mode.

To check (and correct) program data

- Press **PROG** when the MD recorder is stopped.
- Every time **▶▶** is pressed, the track numbers and sequential order of the programmed tracks can be checked one after another. The display of the track number can be returned (sequentially in reverse order) by pressing **◀◀**.
- If you want to correct the program data, press a numeric button to select the track to replace the one displayed. The previously programmed track will be cleared from the memory and the new one will be programmed. To complete the correction, press **PROG** or **▶/◀** once again.

Random play

All the tracks on a disc can be played randomly.

Press **RANDOM** to begin random play.

- * The "RANDOM" indicator (②) will light up.

To cancel the random play

Press **□**, or press **RANDOM** so that the "RANDOM" indicator (②) will go out.

Note

This feature will not function during programming or program play.

Recording to MD

The MD recorder allows you to make recordings from a wide variety of program sources (both analog and digital). When recording an analog source (such as an LP or tape), the MD recorder converts the analog signals to 44.1 kHz digital signal before recording them onto the MD. When recording a digital source, the MD recorder converts the digital signals to 44.1 kHz for recording onto the MD. However, if you are recording a 44.1 kHz source signal (such as a CD) there is no conversion. The MD recorder can record 32, 44.1 and 48 kHz digital signals.

Note

Adjusting the **VOLUME**, **BASS** and **TREBLE** controls, **YMERSON**, **B. BOOST** and **MUSIC** buttons have no effect on the recorded sound. The recording level is automatically adjusted.

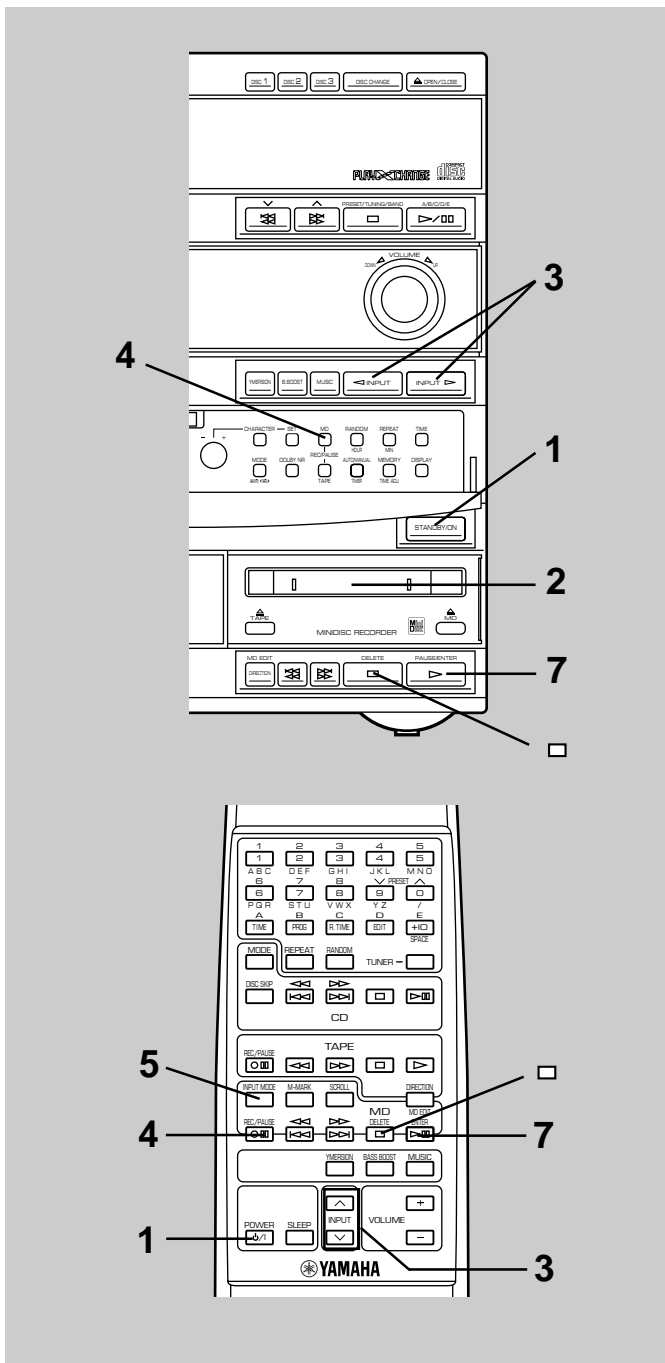

Basic recording

- 1 Turn on the power.
- 2 Insert an MD into the disc insertion slot in the direction of the arrow printed on the MD.
- 3 Select the input source by pressing **INPUT** \triangleright or \triangleleft .
 - * If necessary, locate the point on the source where you want to start recording and suspend the play at the point.
- 4 Press **MD REC/PAUSE**.
 - * The MD REC (④) indicator lights up.
- 5 Select the proper input mode by pressing **INPUT MODE**.
 - **When recording a CD source or the source connected to the DIGITAL IN terminal on the rear of the main unit.**
Select the Digital Stereo mode so that "DIGITAL" (⑦) lights up on the display.
 - **When recording other sources**
Select the Analog Stereo mode so that there is no illumination on the input mode indicator (⑦).
 - For the Digital Mono or Analog Mono input mode, refer to "Monaural recording" on page 31.
- 6 Start playing the program source to be recorded.
 - * If a CD is played, recording also begins automatically. (CD Synchronized Recording)
- 7 Press \triangleright (or \triangleright \square on the remote control) to start recording.
 - * "TOC" (⑨) lights up.
When "TOC" is illuminated, this means that the TOC information has not yet been written to the disc.

To suspend recording

Press **MD REC/PAUSE**.
Press \triangleright again to resume recording.

To stop recording

Press \square .

Recording to both tape and MD

You can record a source to a tape and MD at the same time by pressing both **TAPE** and **MD REC/PAUSE** in step 4 (except using the EDIT function).



Monaural recording

Recording in monaural (mono) allows you to record up to 148 minutes of sound on one 74 minute MD. This may be useful when recording a long interview, debate, or other long time sources on one disc.

1 Select the proper input mode by pressing **INPUT MODE**.

When recording a CD source or the source connected to the DIGITAL IN terminal on the rear of the main unit. Select the Digital Mono mode so that "DIGITAL MONO" (⑦) lights up on the display.

When recording other sources

Select the Analog Mono mode so that "MONO" (⑦) lights up on the display.

2 Follow the procedure of "Basic recording" on page 30.

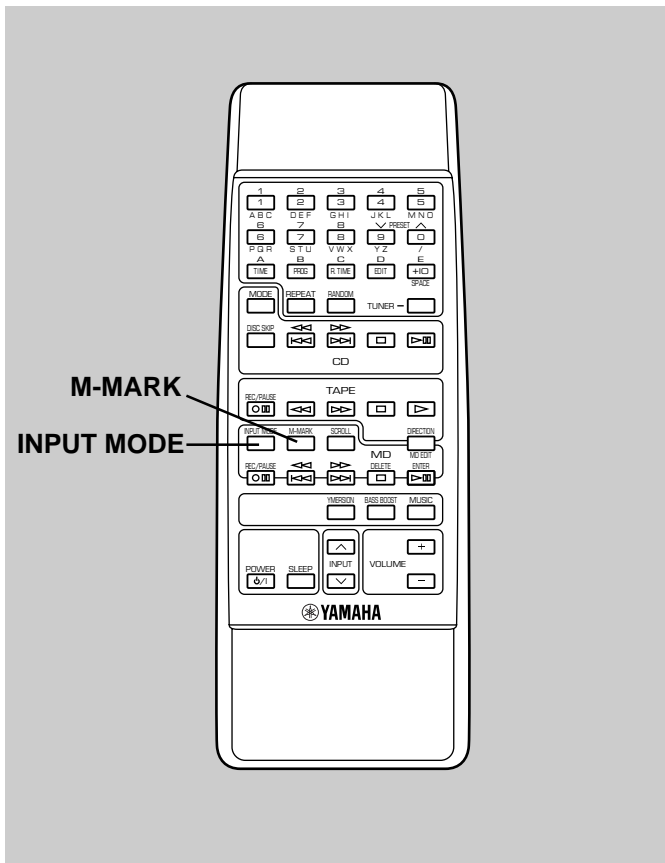

Track-marking

The MD recorder provides both automatic and manual methods for the track number-marking.

- **Automatic (default setting)**

When making a recording, the track-marking is made automatically.

- **Manual**

To make the track-marking manually, press **M-MARK** on the remote control repeatedly until "MANUAL" (⑧) is illuminated.

When recording analog signals (from tapes, radio programs, etc.)

Automatic:

Track numbers are written in synchronization with the input level of the signal being recorded. During recording, if no sound is detected for more than 1.5 seconds, the recorder interprets this to be a gap between two tracks. When the source signal is detected again, a track number is automatically written.

Manual:

One track number is written automatically when you start recording, but none are written during recording. To mark a track number, press **M-MARK** at the desired position while recording.

Note

When using the manual method, the marks must be set at least 4 seconds apart.

When recording digital signals (from CDs, etc.)

Track numbers are written in the same positions as the original source (CDs, etc.) with either automatic or manual track-marking method.

To add additional track numbers, select the manual track-marking method and press **M-MARK** at the desired position while recording.

Notes about TOC

TOC (Table of Contents) is the non-audio data contained on all minidisks (track numbers, play time, title data, etc.) When you make recording onto an MD, the TOC data is automatically renewed.

When the message "TOC Reading" or "TOC Writing", etc. is shown on the display, it means that the MD recorder is reading the TOC data on an MD, or recording TOC data onto an MD. During this period, do not make an operation on the MD recorder, do not disconnect the power cord of this system, or do not shake this system to prevent a misoperation of the MD recorder.



Recording from CDs utilizing the EDIT function

The EDIT function makes recording operation easier.

EDIT recording

Tracks of a CD are recorded onto an MD with the original order unchanged.

If the CD's total play time exceeds the total recordable time of the selected MD, all tracks will not be recorded, but recording will not finish in the midst of playing a track.

- 1 Select the CD player by pressing **INPUT** \triangleright or \triangleleft until "CD" (①, ⑤) appears on the display.
- 2 Select the disc by pressing **DISC SKIP**.
- 3 Insert an MD into the disc insertion slot in the direction of the arrow printed on the MD.
- 4 Press **MD REC/PAUSE**.
- 5 Press **R. TIME** on the remote control. The (remaining) recordable time of the MD is displayed by minute (as "MD-00").
- 6 Press **EDIT**. ("EDIT" (⑫) lights up on the display.)
 The following operations are carried out automatically.
 - 1) Tracks on the CD are automatically programmed for recording. You can check the process by watching the display.
 - 2) Both CD play and recording starts.

Notes

- When the CD player is in the all disc play mode, if the total recordable time of the MD is longer than the total playing time of the selected CD, tracks on another CD are recorded continuously. In this case, as many as three CDs can be recorded automatically.
- The CD player's repeat play mode will be canceled during this recording mode.

Auto-EDIT recording

This recording automatically changes the order of tracks so that the unrecorded space of the MD is minimized.

- 1 Follow steps 1–5 of "EDIT recording" above.
- 2 Press **PROG**.
- 3 Press **R. TIME**.
 Tracks will be automatically programmed.
 * You can check the programmed contents by pressing $\triangleright\triangleleft$ of the CD player.
- 4 Press **EDIT**. ("EDIT" (⑫) lights up on the display.)
 The recording starts.

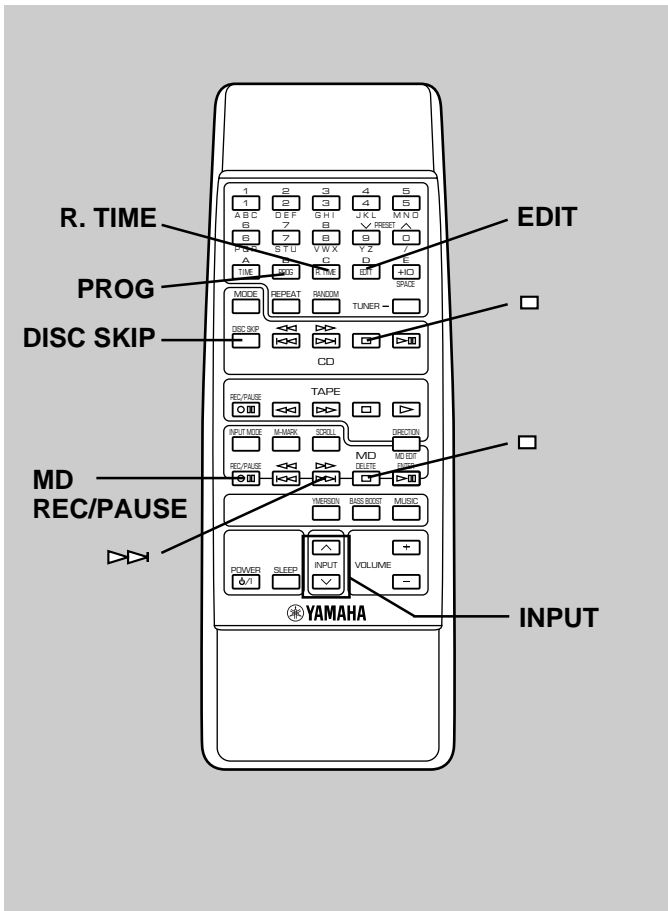

To cancel the EDIT function

Before recording, press \square of the CD player or the MD recorder.

To stop recording

Press \square of the MD recorder.

(At this time, CD play automatically stops.)



Manual EDIT recording

You can program tracks manually while watching the remaining time on the MD.

- 1 Press **INPUT** \triangleright or \triangleleft once or more until "CD" (①, ⑤) appears on the display, and load a CD (or CDs) on the disc tray.
- 2 Follow steps 2–5 of "EDIT recording" on page 32.
- 3 Press **PROG**.
 - * "PROG" and "P-01" will light up on the display, and all track numbers on the selected CD will begin flashing.
- 4 If necessary, select the desired CD by pressing **DISC SKIP**.
- 5 Select the desired track number by pressing the numeric buttons.
- 6 Repeat steps 4 and 5 to program more tracks. You can select the same track again.
 - * Pressing **TIME** displays the total remaining time on the MD for about 1 second, and then it is replaced by the display of the next play order.
 - * If "TM OVER" appears on the display, the track number just selected cannot be programmed because there is not enough time remaining on the MD. However, at this time, if any other track number is flashing continuously on the display, you can program it instead of the unprogrammable one.
- 7 Press **EDIT**. ("EDIT" (⑫) lights up on the display.) The recording starts.

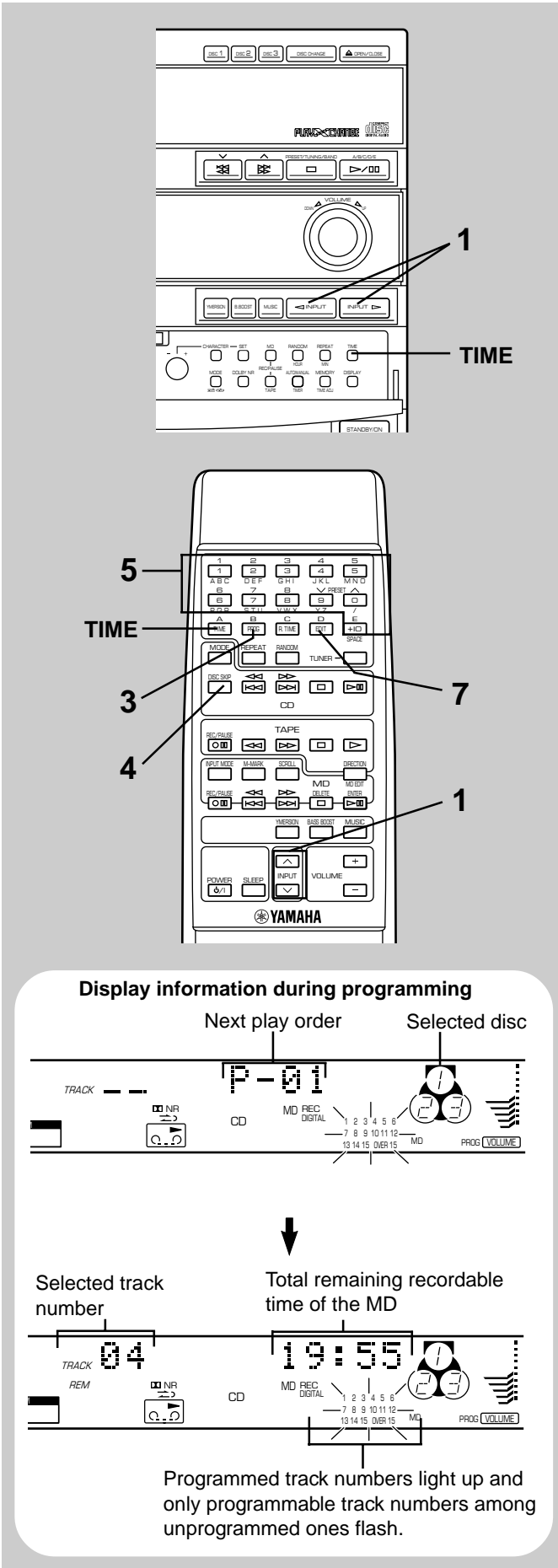

Notes on recording with the EDIT function

- To check, cancel or correct program data, refer to page 11.
- The maximum number of tracks that can be programmed is 20.
- The track number 16 or higher cannot be programmed by this function.

Editing and titling MD

Editing an MD

One of the main advantages of MD is its editing capabilities, you can remove the commercials from a radio broadcast, arrange songs into the order you want, remove songs, combine songs, even remove part of a song.

The MD recorder offers the following editing functions.

- **Erase**
Lets you erase a track, the entire disc, or part of a track. You can also erase the title of a disc, or the titles of tracks on a disc.
- **Move**
Lets you move a track to a different track number.
- **Combine**
Lets you combine two adjacent tracks.
- **Divide**
Lets you split a single track into two different tracks.
- **TOC Write**
Lets you write TOC information to the disc so that changes are saved.
- **FRA Check**
Lets you recover disc space that may have been lost after repeated editing operations.
- **Undo**
Lets you undo the previous editing operation if you make a mistake.

Notes on editing

Before editing

Make sure that the MD is not protected against erasure. If the MD is protected, you cannot edit the MD. Slide the tab to close the slot on the side of the MD.

After editing

Use the **TOC Write** function, or press \triangle and pull the MD out in order to update the TOC information.

Note

After performing an editing operation, "TOC" (⑨) lights up on the display to show that the TOC information has not yet been written to the disc. **Undo** is possible only when "TOC" (⑨) is illuminated.

The illustrations below show the locations of buttons used for editing operations described on pages 35–37.

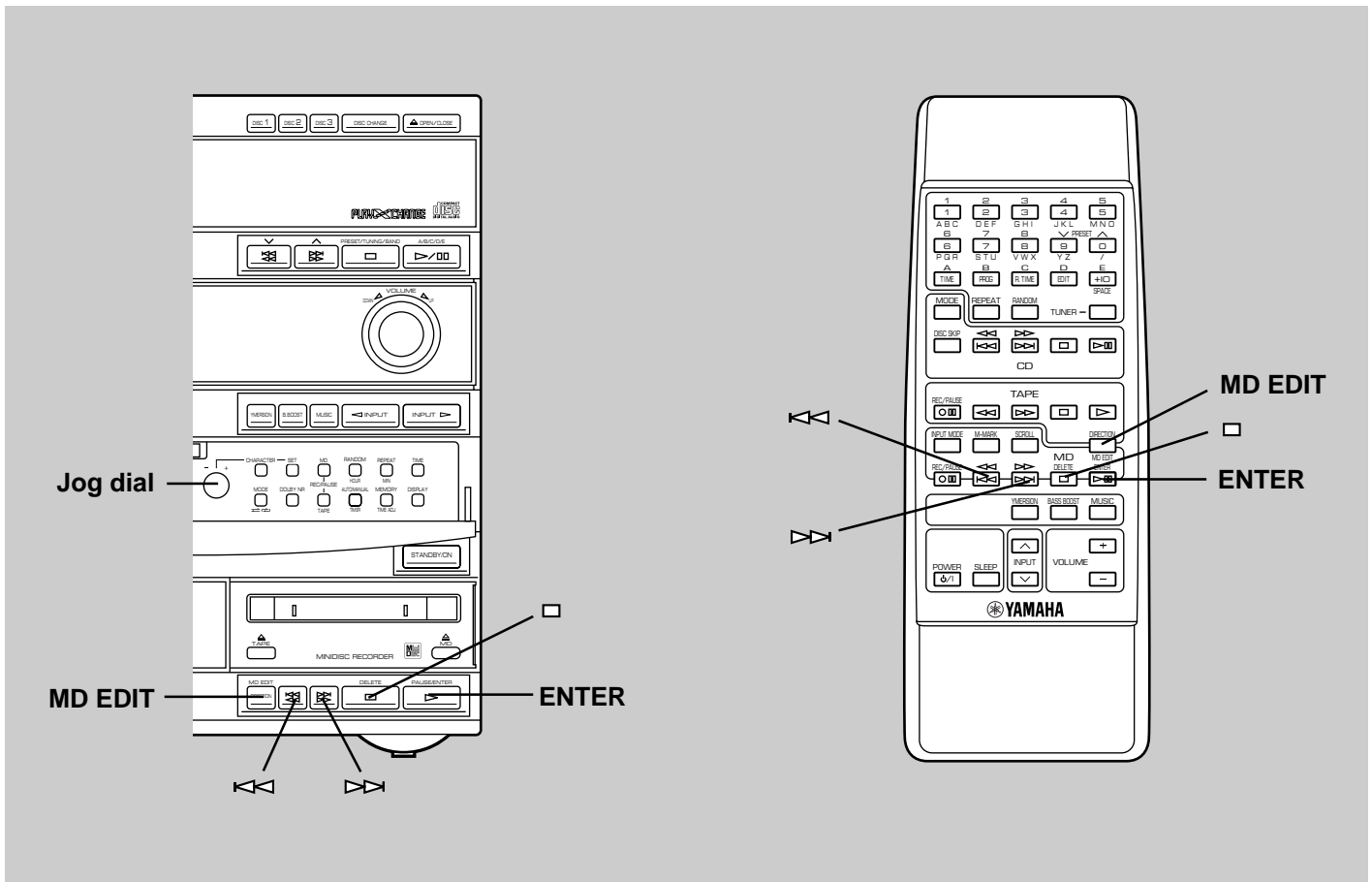



■ Erase

This function lets you erase the entire disc, a track or part of a track quickly and easily. You can also erase the title of a disc, or the titles of tracks on a disc. Please note that once erased, the data can be recovered by using the **Undo** function.

To clear out the MD

This operation lets you erase all audio and title (character) data to create a blank MD.

- 1 Press \square to stop the MD recorder.
- 2 Press **MD EDIT** repeatedly to display "Disc Erase ?", then press **ENTER**.
* "DiscEraseOK?" appears on the display.
- 3 Press **ENTER** again.
* When all audio, name and title data has been erased, "Complete" appears momentarily.

To erase a single track

This operation lets you erase a single track including the corresponding title data. After you erase the track, the total number of tracks decreases by one and all tracks following the erased one are renumbered.

Example: Erasing track 3

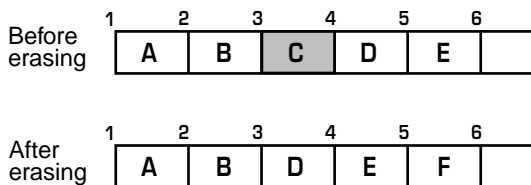

- 1 Turn the jog dial or press \lll/\ggg to select the track you want to erase.
- 2 Press **MD EDIT** repeatedly to display "(track number) Erase ?", then press **ENTER**.
* "EraseOK?" appears on the display.
- 3 Press **ENTER** again.
* The track is erased and "Complete" appears momentarily.

If you plan to erase two or more tracks

To avoid confusion, you should always erase from higher track numbers to lower track numbers. This prevents accidental renumbering of tracks you plan to erase.

To erase part of a track

- 1 Play the track containing the part you want to erase.
- 2 Press **MD EDIT** repeatedly to display "A-B Erase ?".
- 3 Press **ENTER** at the beginning of the part you want to erase (point A).
* Point A is registered and "Erase A-_" appears on the display.
- 4 Press **ENTER** again at the end of the part you want to erase (point B).
* Point B is registered and "Check" appears. Then the part you specified plays repeatedly and "Erase A-B?" appears on the display.

To adjust point B

Turn the jog dial while the "B" of "Erase A-B?" is blinking. Point B can be adjusted up to 2 second in either direction.

- 5 Press **ENTER** again.
* The part is erased and "Complete" appears momentarily.

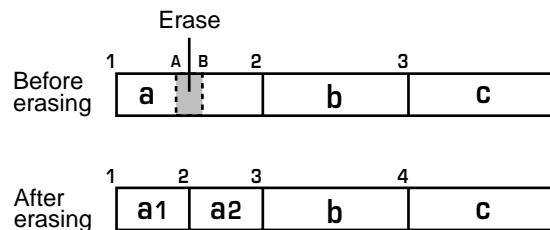

Notes

- After this operation, a new track number is automatically assigned to the section starting after point B.
- Point B cannot be positioned before point A.

When you cannot edit because of the limitations of the MD system, "Can't Edit" appears on the display and the **Erase** function is canceled.



Editing and titling an MD

To erase the title of a disc

- 1 Press \square to stop the MD recorder.
- 2 Press **MD EDIT** repeatedly to display "Title Erase?", then press **ENTER**.
 - * "Disc Title" and "Erase OK?" appear alternatively on the display.
- 3 Press **ENTER** again.
 - * "The disc title is erased and "Complete" appears momentarily.

To erase the title of a track

- 1 Turn the jog dial or press \lll/\ggg to select the track whose title you want to erase.
- 2 Press **MD EDIT** repeatedly to display "Title Erase?", then press **ENTER**.
 - * "Track Title" and "Erase OK?" appear alternatively on the display.
- 3 Press **ENTER** again.
 - * The track title is erased and "Complete" appears momentarily.

Notes

- When "Title Erase" is appearing on the display, either "DISC" or "TRACK" indicator (①) will be illuminated to show which title is ready to be erased, the disc title or track title.
- To avoid wrong erasing, it is recommended to confirm the title which you are planning to erase by pressing **TIME** repeatedly until the title appears on the display.

Move

This function lets you change the position of any track. When you move tracks, all the tracks are automatically renumbered.

Example: Moving track 2 to the track number 4

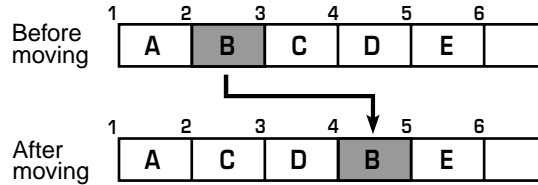

- 1 Turn the jog dial or press \lll/\ggg to select the track you want to move.
- 2 Press **MD EDIT** repeatedly to display "(track number) Move ?", then press **ENTER**.
- 3 Turn the jog dial or press \lll/\ggg to select the track's destination (new track number).

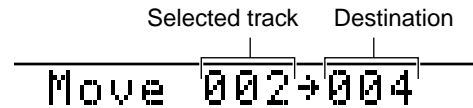

- 4 Press **ENTER**.
"Complete" appears momentarily on the display.

Combine

This function lets you combine two consecutive tracks into one. After you combine the tracks, the total number of tracks decreases by one and the tracks are automatically renumbered.

Example: Combining tracks 2 and 3

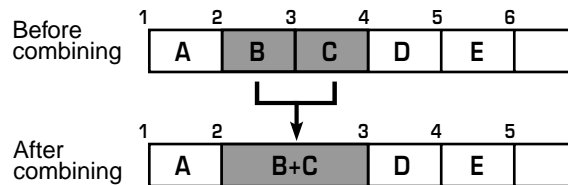

- 1 Press \square to stop the MD recorder.
- 2 Turn the jog dial or press \lll/\ggg to select the second track of the two you want to combine.
- 3 Press **MD EDIT** repeatedly to display "(track number) Combine?", then press **ENTER**.
 - * "Check" appears momentarily, then the MD recorder plays the 4 seconds before and after the point where the tracks will be connected. "(track number) + (track number) OK?" appears on the display.
- 4 Press **ENTER** again.
 - * The tracks are combined and "Complete" appears momentarily.
 - * If the second track of the two combined had a track title, it is deleted.



■ Divide

This function lets you divide one track into two separate tracks by adding a new track number to a certain point in the track.

Example: Dividing track 3

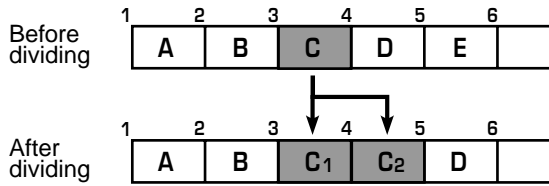

- 1 Play the track you want to divide.
- 2 Use << or >> to locate the point where you want to divide the track, then press > (or > on the remote control) to pause at that position.
- 3 Press **MD EDIT** repeatedly to display “(track number) Divide?”, then press **ENTER**.
 - * “Check” appears momentarily, then “Divide OK?” appears and the MD recorder starts repeating the point where the track will be divided.
- 4 If necessary, use the jog dial to adjust the position of the point where the track will be divided.
 - * The dividing position can be adjusted up to 2 second in either direction.
- 5 Press **ENTER**.
 - * The track is divided and “Complete” appears momentarily.
 - * If the divided track originally had a track title, the same title remains on both of the two divided.

■ To undo the editing

The **Undo** function lets you immediately return to the condition before an editing is made (note; you cannot undo the editing once you press any other button).

- 1 Press □ to stop the MD recorder.
- 2 Press **MD EDIT** repeatedly to display “Undo █*1”, then press **ENTER**.
 - * “Undo OK?” appears on the display. To cancel undoing, press □.
- 3 Press **ENTER** again to undo.

█*1: The name of editing you can undo is displayed here.

■ To cancel the editing

Press □.

■ Disc Maintenance

The MD recorder features two disc maintenance functions which optimize performance of MDs. The **TOC Write** function allows you to write the result of editing to the TOC without having to eject the disc. The **FRA Check** function recovers recordable space on a disc that may have been lost because of repeated editing operations.

TOC Write

When making a recording, the TOC (Table Of Contents) of the MD is written as soon as recording is finished. When making an editing or titling operation, however, the TOC isn't automatically written unless the disc is ejected. If the MD recorder is accidentally turned off before writing the result of editing to the TOC, it is possible that these changes will not be saved. By using this function, you can ensure that the result of your edition is saved on the disc.

- 1 Press □ to stop the MD recorder.
- 2 Press **MD EDIT** repeatedly to display “TOC Write?”, then press **ENTER**.
 - * “TOC WriteOK?” appears on the display.
- 3 Press **ENTER**.
 - * “TOC Writing” flashes on the display momentarily.

Notes

- You cannot undo the result of editing once it has been written to the TOC.
- The **TOC Write** function can only be selected when the TOC indicator is lit on the display.

FRA Check

When editing operations such as “**Move**” and “**Divide**” are performed, recordable space may be lost and “TOC Full” may appear on the display to indicate that no more recording can be performed. When this occurs, it may be possible to recover the FRA (Freely Recordable Area) on the disc that was lost by repeated editing operations so that more recording is possible.

- 1 Press □ to stop the MD recorder.
- 2 Press **MD EDIT** repeatedly to display “FRA Check?”, then press **ENTER**.
 - * “FRA CheckOK?” appears on the display.
- 3 Press **ENTER**.
 - * “Complete” appears momentarily.



Editing and titling an MD

Titling an MD or track

This function lets you title recorded MDs and individual tracks. Titles may consist of capital and small letters, numbers, and symbols for a maximum of 250 characters for each title.

To title a disc

Make the following titling operation when the MD recorder is stopped.

To title a track

Make the following titling operation during play, pause or recording. The currently selected track or currently recorded track is titled.

If the MD recorder is stopped, use the jog dial or press \lll/\ggg to select the track you want to title.

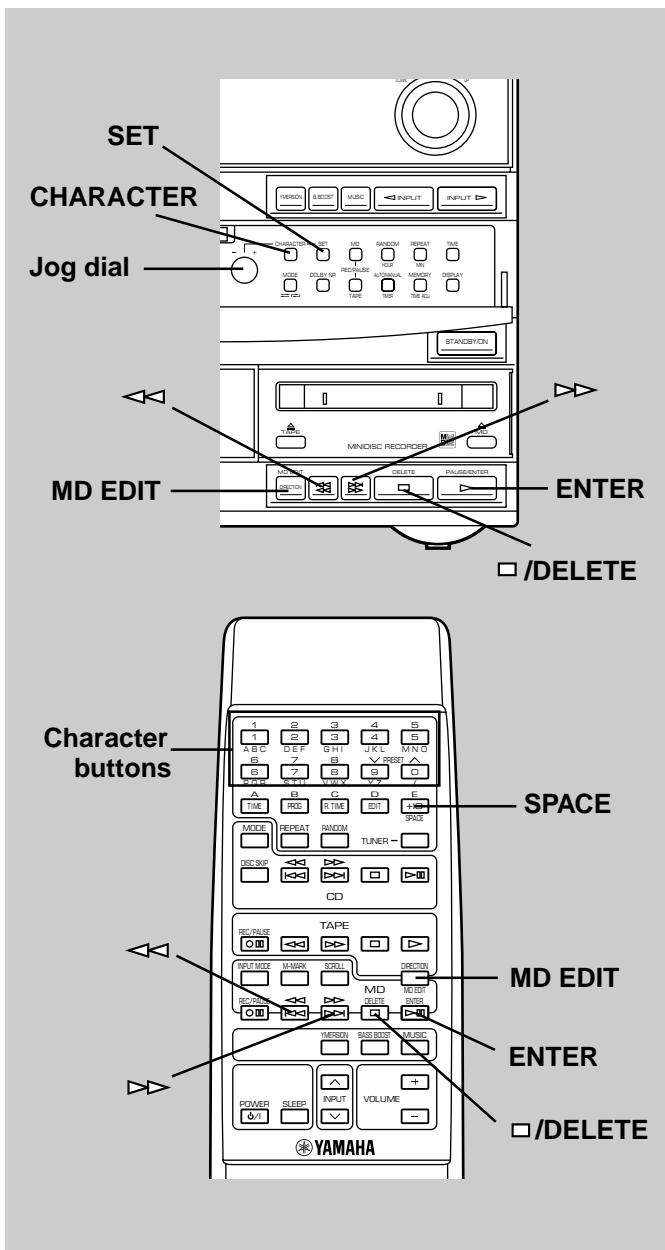

1 Press **CHARACTER**.

* The cursor appears on the display.

2 Press **CHARACTER** repeatedly to select the group of capital letters "ABC..", small letters "abc.." or numbers "012..".

* If you need the group of symbols, select "012..".

3 Turn the jog dial or press a character button (on the remote control) to select the desired character.

Examples of using the character buttons on the remote control

• To select "C"

After selecting "ABC.." in step 2, press **ABC** repeatedly until "C" appears on the display.

• To select "e"

After selecting "abc.." in step 2, press **DEF** repeatedly until "e" appears on the display.

• To select "7"

After selecting "012.." in step 2, press **7 (STU)**.

4 Press **SET** to store the selected character.

* The cursor moves to the next character position.

5 Repeat steps 2 to 4 to complete the titling.

To delete a character (ABCD → ABD)

① Use \lll or \ggg to move the cursor to the position of the character you want to delete.

② Press **DELETE**.

To insert a character (ABCD → ABCD)

① Use \lll or \ggg to move the cursor to the position where you want to insert the character.

② Use **CHARACTER** and the jog dial to select the new character.

③ Press **SET** to set the character. The character previously in that position automatically moves to the right.

To insert a space (ABCD → AB_CD)

① Use \lll or \ggg to move the cursor to the position where you want to insert the space.

② Press **SPACE** on the remote control.

6 Press **ENTER** to exit the titling mode.

* If a title consists of more than 12 characters, it will scroll across the display once, and then be displayed in abbreviated form (first 12 characters only).

To undo titling

1 Press \square to display the total tracks and total playing time on the disc.

2 Press **MD EDIT** repeatedly to display "Undo Title", then press **ENTER**.

* "Undo OK ?" appears on the display.

3 Press **ENTER** again to undo.

7 Store the title(s) you made on the MD by following the procedure of the **TOC Write** function on page 37 or by ejecting the MD.

Note

When titling a track during play, the current track is repeatedly played while entering the title.

Operating an external unit connected with this system

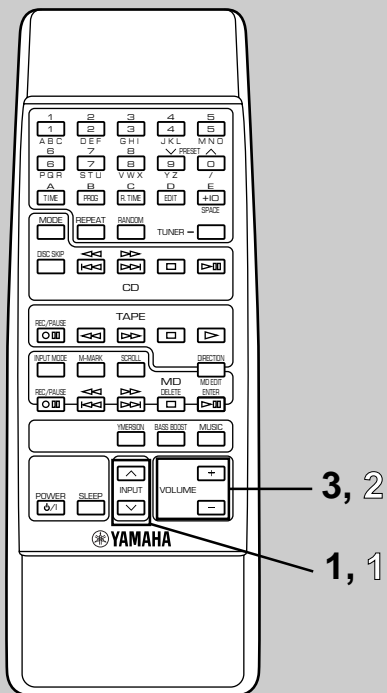
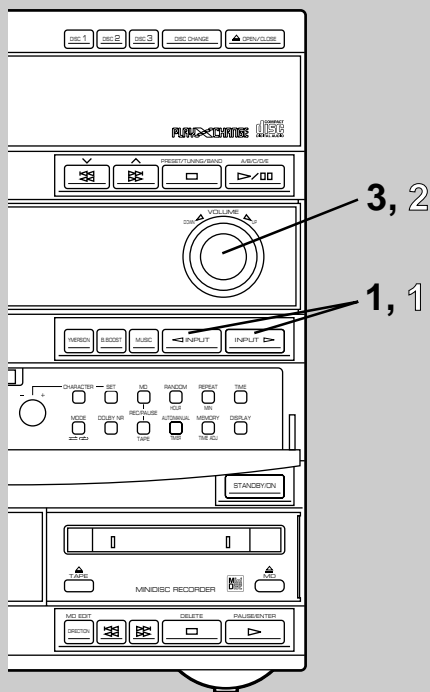

Use the external unit connected to the DIGITAL IN (OPTICAL) or AUX IN terminals on the rear of the main unit.

■ To listen to a source played on the external unit connected with this system

- 1 Press **INPUT** \triangleright or \triangleleft until "AUX Digital" or "AUX Analog" appears on the display.
 - * Select "AUX Digital" to use the unit connected to the DIGITAL IN (OPTICAL) terminal, or select "AUX Analog" to use the unit connected to the AUX IN terminals.
- 2 Play the source.
- 3 Adjust the volume to the desired level by using **VOLUME**.
 - * If you prefer, you can control the sound quality by using the built-in graphic equalizer (**MUSIC**), **BASS**, **TREBLE**, **B. BOOST** and/or **YMERSSION**. (Refer to pages 40–41 for details.)

■ To record a source played on this system by using the tape deck, etc. connected to this system

If an external tape deck, etc. is connected to the AUX OUT terminals on the rear of the main unit, you can record a source played on the built-in CD player, MD recorder, tape deck or a radio program by the tape deck, etc.

Note
Recording level cannot be adjusted with this unit.

- 1 Select the source (CD, MD, TAPE or TUNER) you want to record by using **INPUT** \triangleright or \triangleleft .
- 2 Play the source and then turn **VOLUME** up to confirm the input source.
- 3 Begin recording on the tape deck, etc.

Note
A digital-to-digital recording is possible from an LD (DVD) player, satellite tuner, DAT, etc. connected to the DIGITAL IN (OPTICAL) terminal on the rear of the main unit to the built-in MD recorder. Refer to page 30 for details.

Various sound control

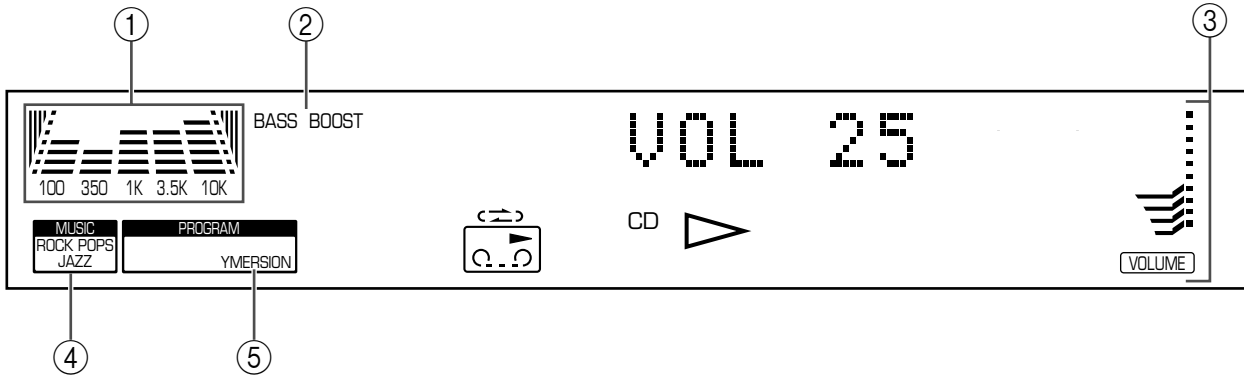

① Spectrum analyzer

The spectrum of the input source which is divided in five bands will be indicated in real time.

② BASS BOOST

③ VOLUME (volume level meter)

④ MUSIC (preset equalizer mode indicator)

⑤ YMERSION

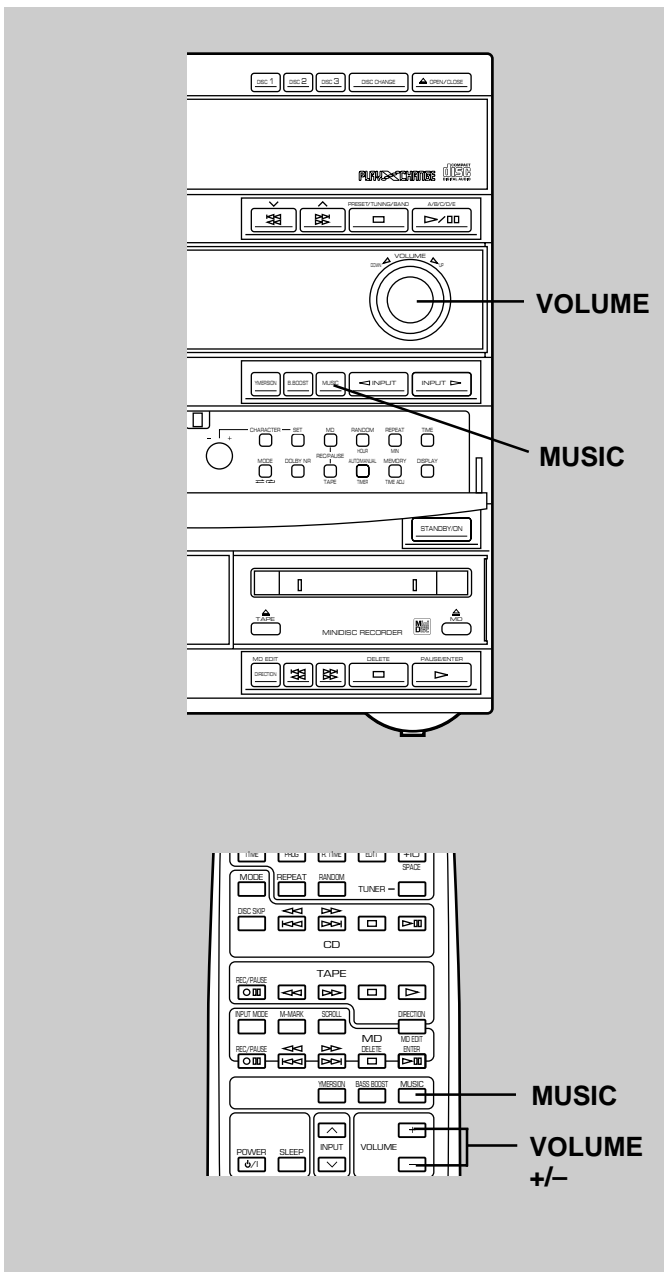

■ VOLUME control

Front panel operation

Rotate **VOLUME** in the “UP” direction to increase the volume, and the “DOWN” direction to decrease the volume.

Remote control operation

Press **VOLUME +** to increase the volume and **VOLUME -** to decrease the volume.

* Adjusted volume level is shown by the volume level meter (③) and in figures on the display.

■ Graphic equalizer

The built-in graphic equalizer provides 3 preset equalizer modes as listed below.

Preset graphic equalizer modes

Mode	Feature
ROCK	High and low frequencies are emphasized. This mode is suitable for reproducing dynamic and powerful sounds of rock music, etc.
POPS	Vocals are emphasized and whole sound is clear. This mode is suitable for pops.
JAZZ	High frequencies for piano, sax, etc. are emphasized. Medium frequencies for vocals are also emphasized moderately.

Listening to the music with a preset equalizer effect

1 Play back a source.

2 Press **MUSIC** once or more so that the name of the desired mode appears on the preset equalizer mode indicator (MUSIC) (④).

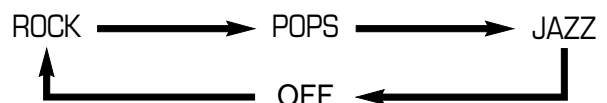

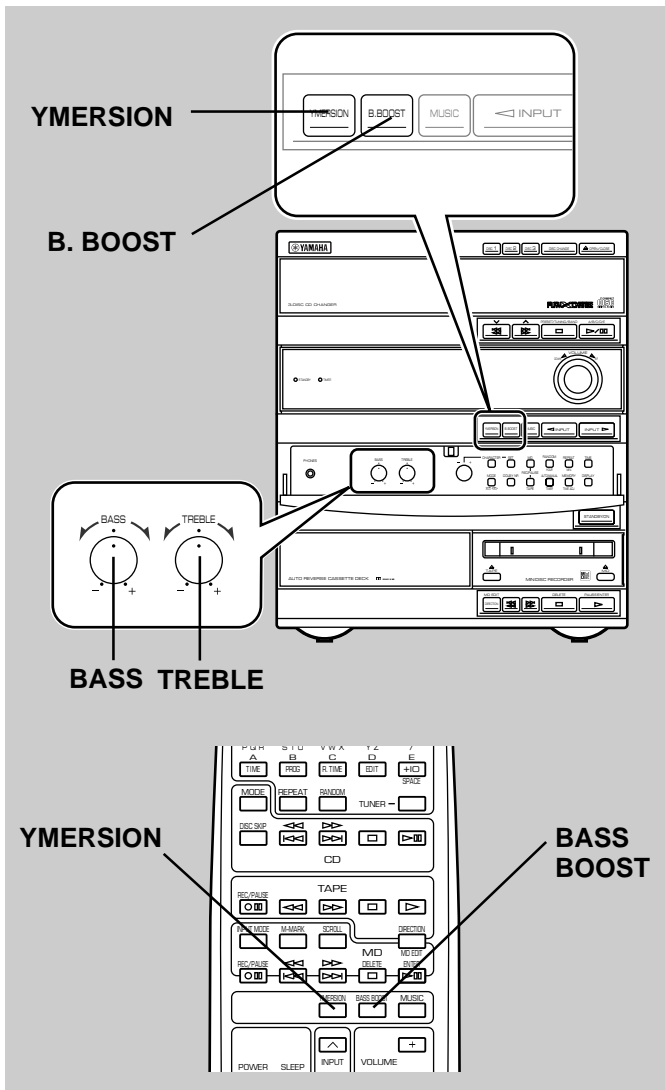

■ B. (BASS) BOOST button

Press this button so that “BASS BOOST” (②) is illuminated on the display to boost the bass frequency response at the left and right channels while maintaining overall tonal balance. This function is effective for reinforcing the bass frequencies when a subwoofer is not used.

■ BASS and TREBLE controls

BASS : Turn this knob clockwise to increase (or counterclockwise to decrease) the low frequency response.

TREBLE : Turn this knob clockwise to increase (or counterclockwise to decrease) the high frequency response.

■ YMERISION button

Press this button so that “YMERISION” (⑤) is illuminated on the display. YMERISION is Yamaha’s proprietary technology that enhances the spread of a normal stereo source play sound, creating three-dimensional acoustics using only two speakers. Press this button again so that “YMERISION” (⑤) goes out from the display to cancel this sound effect.

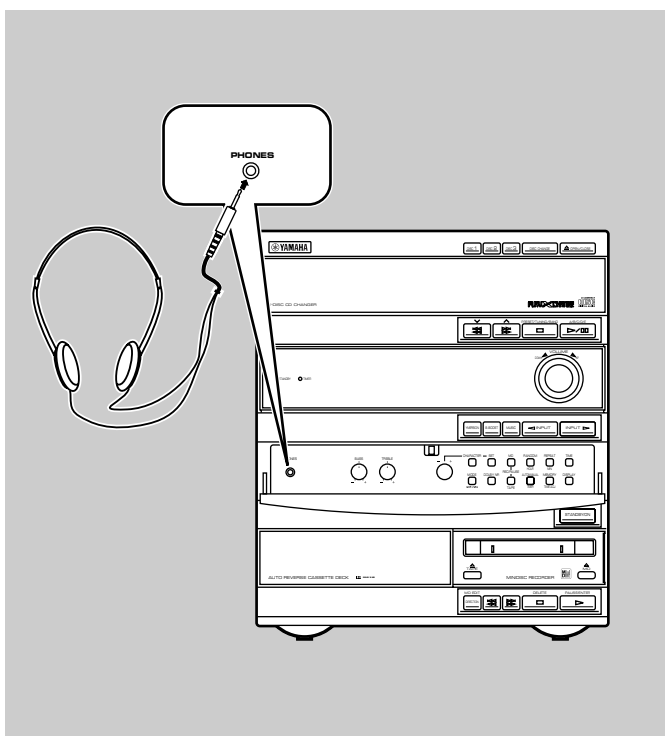

■ Listening with headphones

- Be sure that your headphones have a 3.5 mm (1/8”) diameter plug and between 16 ohms and 50 ohms impedance. Recommended impedance is 32 ohms.
- When you listen with headphones, connect the headphones to the **PHONES** jack. You can listen to the sound that is normally output from the speakers through headphones. Adjust **VOLUME** to a comfortable listening level.

Using the built-in timer

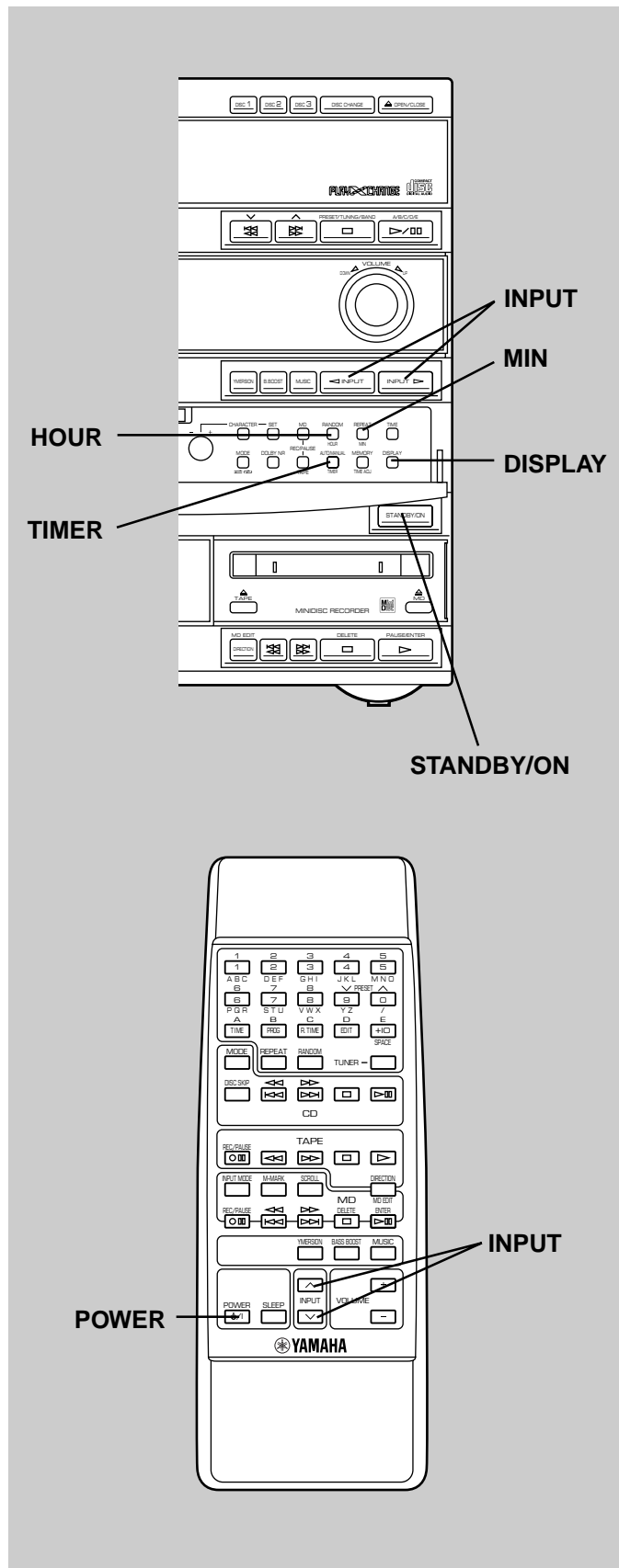

Timer play

By using the built-in timer, you can set the time when this system turns on and a source play begins, and the time when this system will be set to the standby mode automatically.

1 Press **DISPLAY**.
Whenever **DISPLAY** is pressed, the display mode changes as follows.

- 1 Current time (TIMER on/off mode)
- ↓
- 2 Source selecting mode (TAPE, TUNER, CD, MD)
- ↓
- 3 ON TIME/Time setting mode
- ↓
- 4 OFF TIME/Time setting mode
- ↓
- 5 Normal display mode

Note

The display mode will change in after about 8 seconds. If the mode is changed before the setting is completed, call the mode again by pressing **DISPLAY** once or more.

- 1 Current time**
Make sure that the current time is correct, and press **TIMER** so that "TIMER" lights up on the display.
- 2 Source selecting mode**
Select the source to be played with **INPUT** **▷** or **◁**.
- 3 ON TIME/time setting mode**
["ON TIME" appears on the display, and soon it is changed to a time setting mode.]
Set the time when you want to begin the timer play.
 - Press **HOUR** and set the hour.
 - Press **MIN** and set the minute.
- 4 OFF TIME/time setting mode**
If necessary, set the time when you want to finish the timer play in the same way as you did in step **3**. If you do not set the time, it will be automatically set so that the timer play finishes after 1 hour.

2 Press **TIMER** to complete the timer play setting.
This system turns into the standby mode.
* The **STANDBY** and **TIMER** indicators light up.
If you will continue using this system, press **STANDBY/ON** to turn on this system.

To cancel the timer play setting
Press **DISPLAY**, and then press **TIMER** so that "TIMER" goes out from the display.
* When this system is in the standby mode, press **TIMER** so that the **TIMER** indicator goes out.

Note
Unless there is a power failure for more than 5 minutes, the set time will be retained until it is reset.

Timer recording

1 To make recording onto a tape, follow steps 3–4 of “Basic recording” on page 21.

To make recording onto an MD, follow steps 2, 3 and 5 of “Basic recording” on page 30.

2 Tune in to the station you want to record.

3 Follow step 1 of “Timer play” on page 42.

- In step **2**, select “TUNER”, and then press **REC/PAUSE**.

* Press **TAPE REC/PAUSE** for making recording onto a tape, and press **MD REC/PAUSE** for making recording onto an MD. (“REC >TAPE (or MD)” and the frequency will flash alternately on the display.)

* Press both **TAPE** and **MD REC/PAUSE** for making recording onto a tape and MD at the same time. (“REC >Dual” and the frequency will flash alternately on the display.)

- In step **3**, set the time when you want to begin recording.
- In step **4**, set the time when you want to finish recording.

4 Press **TIMER**.

This system will be set to the standby mode.

- * The **STANDBY** and **TIMER** indicators light up.

To cancel the setting of timer recording

Press **DISPLAY** once or more so that “REC >TAPE (or MD)” flashes on the display. While “REC >TAPE (or MD)” is flashing, press **TAPE (or MD) REC/PAUSE**.

Note

When the timer recording is finished, the timer setting is automatically canceled.

Sleep timer operation

This system will be set to the standby mode automatically when the selected sleep time passes.

1 Play the desired sound source.

2 Press **SLEEP** repeatedly until the desired sleep time appears on the display. The display will change as described below.

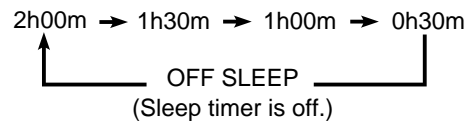

- * The normal display mode will resume about 4 seconds after the selection is made.

- * “SLEEP” will light up on the display.

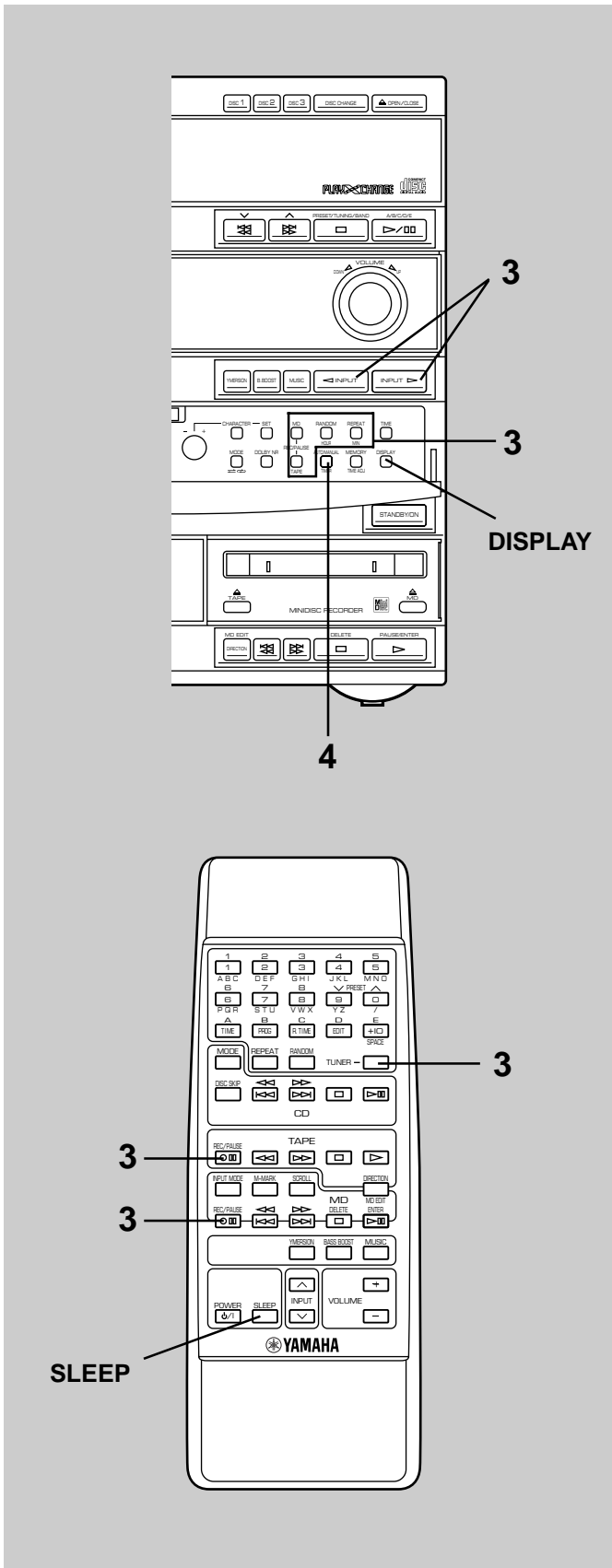

Appendix

Troubleshooting

Refer to the chart below when this system does not function properly. If the problem you are experiencing is not listed below or if the instruction below does not help, disconnect the power cord and contact your authorized YAMAHA dealer or service center.

	Problem	Cause	What to Do
General	This system does not work normally.	There is an influence of strong external noise (lightning, excessive static electricity, etc.) or the system was operated incorrectly.	Set this system to the standby mode and disconnect the AC power cord from the AC outlet. After about 30 seconds pass, connect the power and operate this system again.
	The sound suddenly goes off.	The protection circuit was activated because of a short circuit, etc.	Set this system to the standby mode, then turn on to reset the protection circuit.
		The SLEEP timer was activated.	Cancel the SLEEP timer function.
	No sound from speakers.	Speaker connections are not secure.	Secure the connections.
	No sound from the external unit connected with this system.	Incorrect cord connections.	Connect the cords properly. If the problem persists, the cords may be defective.
		Input source selection is not correct.	Make a correct input source selection.
	Timer cannot be set.	Current time is not set.	Set current time.
This system will not operate properly.	The internal microcomputer has been frozen by an external electric shock (lightning, excessive static electricity, etc.) or power supply with low voltage.	Unplug the AC supply lead from the wall AC outlet, then plug in again after about one minute.	
The volume level cannot be increased, or sound is distorted.	The component connected to the AUX/MD terminals on the rear of the main unit is turned off.	Turn on the power to the component.	
Tuner	Excessive static in FM broadcasts.	Interference from starting motor of nearby car.	Position the FM antenna as high and as far away from nearby roads as possible. Use coaxial cable.
		Interference from thermostat of nearby electrical appliance.	
	Noise increases during stereo broadcasts.	Antenna input is too weak due to obstructions or excessive distance from broadcasting station.	Check antenna connections. Install a multi-element type FM antenna if possible.
	Stereo broadcasts are noisy and STEREO indicator blinks on and off.	Insufficient antenna input.	Install an antenna appropriate for the electric field strength of your area.
	Preset stations cannot be selected.	Preset memory has been erased.	Reprogram memory presettings.
	Buzzing or static during AM broadcasts.	Interference from source such as lightning, fluorescent lights, electric motors or thermostat of nearby electrical appliance.	Problem is difficult to eliminate but can be lessened by grounding AM loop antenna.
		TV or microprocessor is being used nearby.	Move away from TV or microprocessor.
AM broadcast sensitivity is poor.	Radio signal is weak or antenna is not properly connected.	Properly connect AM loop antenna.	
		Change orientation of AM loop antenna.	
		Install an external AM antenna.	
CD player	A disc cannot be played back normally, or there is a noise during play.	The disc is not a standard type.	Play another disc.
	Play will not begin even if disc is loaded.	Disc is upside down.	Load disc label side facing up.
		Disc is dirty.	Clean disc.
	No sound.	The input source selection is incorrect.	Select the CD player by pressing INPUT ◀ or ▶ button until "CD" is illuminated on the display.
	Sound stops suddenly (always at the same spot).	Disc is dirty.	Clean disc.
Volume is set too high.		Lower volume.	

	Problem	Cause	What to Do
Tape deck	Tape will not move during playback or recording.	Slack tape wrapped around pinch roller.	Take up slack with a pencil before using.
	Recording is not possible.	Erasure prevention tab is broken off.	Replace tape or cover erasure prevention hole with cellophane tape.
		Head is dirty.	Clean heads.
	Sound is distorted or fades out, or stereo balance is poor.	Head is dirty.	Clean heads.
		Tape is worn.	Replace tape.
	Poor sound quality.	Tape encoded with Dolby NR is played back with this system's Dolby NR off, and vice versa.	Press the DOLBY NR button to select the appropriate mode.
		Head is dirty.	Clean heads.
	Excessive noise.	Head has become magnetized.	Demagnetize heads with head eraser.
	Tape travel stops in middle of playback or recording.	Slack tape coming out of cassette shell.	Take up slack by turning reels with a pencil.
		Tape is creased or torn.	Replace with new tape.
Endless tape is being used.		Do not use endless tapes.	
The beginning of desired selections on tape cannot be found.	Silent gaps between selections are too short.	The function of searching for the beginning of desired selections will not operate unless the silent gaps between selections are at least four seconds long.	
	Excessively soft passages in middle of selections.		
	Conversation, etc. is recorded.		
MD recorder	The MD recorder does not respond to operations.	Disc is dirty or damaged.	Replace the current disc with a new one.
		Disc is damaged ("UTOO ERR appears on the display).	
	Play is not possible.	Disc has been loaded incorrectly.	Reload the disc with the label side facing up, and the arrow pointing toward the disc insertion slot.
		An unrecorded (blank) disc was loaded ("Blank Disc" appears on the display).	Insert a recorded disc.
	Recording is not possible.	Disc is protected against recording. ("Protected" appears on the display).	Slide the protection tab to the closed position.
		A pre-mastered MD is loaded ("PlaybackMD" appears on the display).	Load a recordable disc.
The input source selection is incorrect.		Press INPUT ▷ or ◁ repeatedly to select the correct input source.	
There is not enough blank space left on the disc.		Load a recordable disc with fewer recorded tracks, or erase unnecessary tracks from the current disc.	
The MD cannot be removed when partially inserted.	The carriage lock function has worked.	Insert the disc completely, then press ⏏ to eject it.	
Remote control	Remote control does not work.	Batteries are dead.	Replace batteries.
		Remote control is too far away or tilted too much.	Use within 6 m and 60° radius.
		Direct sunlight or lighting (of an inverter type of fluorescent lamp, etc.) is striking the remote control sensor of the main unit.	Change position of the main unit.
	TV functions strangely when the remote control is used.	Remote control is being used near TV set with a remote control sensor.	Relocate the main unit away from the TV or cover TV's remote control sensor.

MD system limitations

The recording system in your MD recorder is radically different from those used in tape and DAT decks and is characterized by the limitations described below. Note, however, that these limitations are inherent to the MD recording system and are not a result of mechanical trouble.

“Can’t REC” is displayed before the maximum recording time (60 or 74 minutes) has been reached

Once 255 tracks have been recorded on one MD, “Can’t REC” is displayed regardless of the total recorded time.

“Disc Full” is displayed before the maximum number of tracks (255) have been recorded

During Automatic track-marking, fluctuations in emphasis within songs may be interpreted as song intervals, increasing the total number of tracks and causing “Disc Full” to be displayed.

The remaining recording time does not increase even after erasing numerous short tracks

Tracks under 12 seconds in length are not counted and so erasing them may not lead to an increase in the recording time.

“TOC Reading” is displayed continuously

The “TOC Reading” display lasts longer than normal when a brand new (blank) disc is inserted.

The total recorded time and the remaining time on the MD do not total to the maximum recording time

- Recording is done in minimum units of 2 seconds each, no matter how short the material.
- The MD recorder displays the length of the largest continuous blank area as the remaining time. Therefore, if there are several separate blank spaces, the remaining time will only display a time equivalent to the largest continuous blank space.

Tracks created through editing may exhibit sound dropout during search operations.

Track numbers are not recorded correctly

Incorrect assignment or recording of track numbers may result when CD tracks are divided into several smaller tracks during digital recording.

It is not possible to erase part of a track using the A-B Erase function

The MD recorder organizes the audio data in sound groups and clusters. The minimum size of these units may not consist of less than 10 seconds of stereo sound.

The correct recorded/playing time may not be displayed during playback of MDs recorded in monaural.

Copy protection (SCMS)

As a digital audio component, this MD recorder conforms with the Serial Copy Management System (SCMS) standards. The Serial Copy Management System restricts copies made by recording digital signals to the first-generation copies only. Therefore, an MD recorded from a digital input source cannot be used as a source for making another digital recording.

US and foreign patents licensed from Dolby Laboratories Licensing Corporation.

Display messages for MD recorder

Can't Copy

Digital recording cannot be performed. (See "Copy protection (SCMS)" on page 46.)

Can't Edit

Edit operations are not possible.

Can't Play!

Timer playback is not possible. The loaded disc may be blank, damaged, or an incompatible format.

Can't REC!

Timer recording is not possible. The loaded disc may be protected or there may not be enough blank space remaining on the disc.

Can't REC

Recording is not possible because there is not enough blank space remaining on the disc.

DIGin Unlock

No digital signal is being input to the DIGITAL IN (OPTICAL) terminal.

Disc Full

Recording is not possible because there is no blank space remaining on the disc.

Title Full

Additional characters cannot be input for the current title because the maximum number of characters for a single title (250) have already been input.

UTOC WError

Error occurred when writing to the TOC.

Not Audio

The inserted disc is not an audio MD.

Tr Protected

The selected track cannot be edited because it is protected.

TOC Full

The disc area allotted for TOC data has become full and further editing is not possible.

UTOC ERR L...

Problem involving user's TOC data.

TMP Over!!

The temperature of this system has exceeded the normal operating temperature.

TOC Writing

The TOC data is being written to the disc. Do not move this system or pull out the mains lead.

TOC Reading

The MD recorder is reading the TOC data.

Protected

The record protection on the inserted MD is set to "protect".

Playback MD

The inserted MD is designed for playback only (you cannot record on this disc).

Specifications

■ Amplifier section

Minimum RMS Output Power per Channel	
6 ohm, 1 kHz, 0.9% THD	80W+80W
Input Sensitivity/Impedance	
AUX	200 mV/47 k-ohm
Spectrum Analyzer Band	5 band
(100 Hz, 350 Hz, 1 kHz, 3.5 kHz, 10 kHz)	

■ Tuner section

Tuning Range	
FM	87.50 to 108.00 MHz
AM	531 to 1,611 kHz
Usable Sensitivity (FM)	
S/N 30 dB, 1 kHz, 100% Mod.	1.8 μ V

■ CD player section

Type	3 disc carousel auto-changer
D/A Converter	1-bit DAC
Filter	8-time oversampling digital filter
Laser Diode Properties	
Material: GaAlAs	
Wavelength: 780 nm	
Emission Duration: continuous	
Laser Output: max. 44.6 μ W*	
* This output is the value measured at a distance of about 200 mm from the objective lens surface on the Optical Pick-up Block.	

■ Tape deck section

Type	Auto reverse stereo cassette deck
Frequency Response (-20 dB)	
Type 1 (Normal)	50 to 15,000 Hz
Type 2 (High)	50 to 16,000 Hz
Wow and Flutter	0.09%, W.RMS
Signal-to-Noise Ratio	58 dB (Dolby NR OFF)
	66 dB (Dolby B NR ON)
Harmonic Distortion	0.8%

■ MD section

System	Minidisc digital audio system
Recording Method	Magnetic field modulation overwrite
Reading Method	Non-contact optical pick up
Coding	ATRAC (Adaptive TRansform Acoustic Coding)
Laser Diode Properties	
Material: GaAlAs	
Wavelength: 780 nm	
Pulse time:	
Read mode	0.8 mW continuous
Write mode	max. 10 mW 0.5S
	min. cycle 1.5S
	Repetition

■ Speaker section

Type	3-way bass reflex: 13 cm (5") woofer
	5 cm (2") tweeter
	2 cm (3/4") super tweeter
	Magnetic shielding type
Maximum Input	240W
Impedance	6 ohm

■ General

Power Supply	AC 240V, 50 Hz
Power Consumption	150W
	(In the standby mode: 2W)
Dimensions (W x H x D)	
Main unit	280 x 320 x 364 mm
Speaker	200 x 320 x 218 mm
Weight	
Main unit	11.2 kg
Speaker	3.8 kg x 2
Accessories	Remote control
	Batteries
	Speaker cords
	AM loop antenna
	Indoor FM antenna

Specifications are subject to change without notice.

YAMAHA ELECTRONICS CORPORATION, USA 6660 ORANGETHORPE AVE., BUENA PARK, CALIF. 90620, U.S.A.
 YAMAHA CANADA MUSIC LTD. 135 MILNER AVE., SCARBOROUGH, ONTARIO M1S 3R1, CANADA
 YAMAHA ELECTRONIK EUROPA G.m.b.H. SIEMENSSTR. 22-34, 25462 RELLINGEN, BEI HAMBURG, F.R. OF GERMANY
 YAMAHA ELECTRONIQUE FRANCE S.A. RUE AMBROISE CROIZAT BP70 CROISSY-BEAUBOURG 77312 MARNE-LA-VALLEE CEDEX02, FRANCE
 YAMAHA ELECTRONICS (UK) LTD. YAMAHA HOUSE, 200 RICKMANSWORTH ROAD WATFORD, HERTS WD1 7JS, ENGLAND
 YAMAHA SCANDINAVIA A.B. J A WETTERGRENS GATA 1, BOX 30053, 400 43 VASTRA FRÖLUNDA, SWEDEN
 YAMAHA MUSIC AUSTRALIA PTY, LTD. 17-33 MARKET ST., SOUTH MELBOURNE, 3205 VIC., AUSTRALIA

YAMAHA CORPORATION