



DIGITAL MIXING CONSOLE

DM7

DM7 COMPACT

Reference Manual

Table of Contents

Introduction	12
About the Product	12
About Available Documentation	13
About the Utility Software Configuration	14
Firmware Updates	15
Functional Enhancement Packages (Mixer Accessory)	16
Trademarks	17
Installation of Option Cards	18
Connections	21
Analog input connections	21
Analog output connections	23
I/O device connections	25
Daisy-chain connections	26
Star connections	29
Redundant connections	32
Connecting to the DM7 Console (DM7 Control)	35
Part Names & Functions	37
Top Panel	37
Rear Panel	40
Front Panel	44
Part Names & Functions(DM7 Control)	45
Top Panel	45
Rear Panel	48
Basic Operations	51
Basic Operations on the Top Panel	51
Basic Screen Operations	52
On-screen User Interface	53

Screen Overview 56

Tool Bar 56
About the SELECTED CHANNEL VIEW Screen 58
About the OVERVIEW Screen 65

Screens 68

EQ Screen 68
DYNAMICS Screen 73
AUTOMIXER Screen 77
SCENE Screen 81
 Scene List screen 81
 Scene List screen (Comment) 84
 Scene List screen (Focus) 85
 FOCUS screen 86
 Scene List screen (Fade Time) 88
 FADE TIME screen 89
 Individual Fade Time screen 90
 Scene List screen (GPI) 91
 Scene List screen (Playback Link) 92
 PLAYBACK LINK screen 93
 Scene List screen (Scene Link) 94
 Recall Safe screen 95
 Global Paste screen 97
 Scene List screen (MIDI)(Theater Package Compatible) 99
 MIDI TX screen 100
 AFC IMAGE screen 101
GENERAL Screen 102
DELAY COMPENSATION Screen 105

USER SETUP Screen	107
USER SETUP screen	107
PREFERENCE screen	110
Surface screen (DM7 only)	112
CUSTOM FADER screen	113
USER DEFINED KNOBS screen	115
USER DEFINED KEYS Screen	118
CREATE USER KEY screen	121
GUEST USER LEVEL screen	124
BUS SETUP screen	125
BUS SETUP Screen	125
BUS SETUP (Send Point) screen	126
WORD CLOCK Screen	128
MIDI/GPI Screen	131
MIDI/GPI (MIDI Setup) screen	131
MIDI/GPI (Program Change) screen	133
MIDI/GPI (Control Change) screen	136
MIDI/GPI (GPI) screen	137
MIDI/GPI (Fader Start) screen	139
Audio Follow Video Screen (Broadcast Package Compatible)	142
DATE/TIME Screen	144
NETWORK Screen	145
NETWORK (For Mixer Control) screen	145
NETWORK (For Device Control) screen	147
NETWORK screen: IMMERSIVE SOUND tab (Theater Package Compatible)	149
IMMERSIVE SOUND popup window (1CH)	151
IMMERSIVE SOUND popup window (OBJ1-36, OBJ37-72, OBJ73-108, OBJ109-128)	152
OBJECT ASSIGN screen	153
PY Slot screen	155
PY Slot screen	155
PY64-MD screen	156
PY8-AE screen	160
PY64-D screen	162
DM7 CONTROL SETUP Screen	164

PATCH Screen	167
Grid screen	167
Input patch screen (list screen)	169
Output patch screen (list screen)	171
Output port patch screen	172
Recording patch screen	173
Sub In patch screen	174
I/O DEVICE Screen	175
DANTE SETUP (Setup) screen	175
DANTE DOMAIN MANAGER screen	178
DANTE SETUP (Device Mount) screen	180
DEVICE SELECT screen	181
DEVICE LIST screen	182
SUPPORTED DEVICE screen	183
DVS or MANUAL screen	184
DANTE I/O DEVICE screen	185
CONSOLE I/O Screen	187
OMNI IN screen	189
OMNI OUT Screen	191
AES/EBU INPUT screen (DM7 only)	193
AES/EBU OUTPUT Screen	194
PY OUT / DANTE OUT Screen	196
I/O DEVICE screen: HA	197
I/O DEVICE screen: WIRELESS	199
I/O DEVICE Screen: Amplifier	201
DANTE PATCH (Input) screen	203
DANTE PATCH (Output) screen	204
RECORDER screen	205
RECORDER screen	205
RECORDER screen	207
RECORDER screen	209
LIVE REC screen	211
DAW REMOTE screen	213
DAW REMOTE SETUP screen	216

CH JOB Screen	217
DCA GROUP ASSIGN Screen	217
DCA SCENE GRID Screen (Theater Package Compatible)	219
MUTE GROUP ASSIGN screen	220
CH LINK screen	222
CH LINK SET screen	223
CH COPY screen	224
CH DEFAULT screen	225
MONITOR screen	226
MONITOR(MONITOR) Screen	226
MONITOR Screen	228
MONITOR SOURCE DEFINE Screen	231
MONITOR (CUE) screen	232
CUE Screen	234
PHONES screen	237
CUE SETTINGS screen	239
MONITOR (OSCILLATOR) screen	240
OSCILLATOR screen	241
MONITOR (TALKBACK) screen	244
TALKBACK screen	245
RACK Screen	247
RACK screen	247
GEQ Edit screen	248
PEQ Edit screen	251
FX screen	254
Premium screen	256
CH PARAMETER Screen	259
1ch Gain screen	259
12ch Gain screen	261
12ch D.Out screen	263
Insert screen	264
Delay screen	265
Send screen	267
To Stereo screen	269
Fader screen	271
NAME Screen	272
CH LIBRARY Screen	273
ACTOR Screen (Theater Package Compatible)	275

SURROUND Screen (Broadcast Package Compatible) 277

- SURROUND SETUP screen 277**
- DOWNMIX SETUP screen 278**
- Channel Parameter screen (Surround Pan tab) 279**
- Channel Parameter screen (Surround Pan tab) 281**
- MONITOR (MONITOR) screen (Surround) 282**
- MONITOR(MONITOR) screen 285**
- MONITOR SOURCE EXT DEFINE screen 288**
- SURROUND CUE screen 289**
- PHONES screen 290**

UTILITY Screen 292

- Utility Screen 292**
- USER DEFINED KEYS screen 294**
- MONITOR screen 295**
- SCENE LIST Screen 296**
- ASSIST Screen 298**
- SAVE/LOAD screen 299**
- LOUDNESS METER Screen 303**
- LOUDNESS METER SETUP Screen 305**
- SYSTEM Screen 306**
- LICENSE ACTIVATION Screen 307**
- UNIT MODE Screen 308**
- MAINTENANCE Screen 309**
- Initialize All Memory Screen 310**
- Initialize Current Memory Screen 311**
- Initialize Dante Screen 312**
- FADER CALIBRATION Screen 313**
- INPUT PORT TRIM Screen 314**
- OUTPUT PORT TRIM Screen 315**
- LED CALIBRATION Screen 316**

Sound Operations	318
Controlling GAIN via the OVERVIEW Screen	318
Controlling the EQ via the OVERVIEW Screen	319
Controlling the EQ via the SELECTED CHANNEL VIEW Screen	320
Controlling the Dynamics Processor via the OVERVIEW Screen	321
Controlling the Dynamics Processor via the SELECTED CHANNEL VIEW Screen	322
Controlling Inserts via the OVERVIEW Screen	323
Controlling Inserts via the SELECTED CHANNEL VIEW Screen	324
Directly Outputting an Input Channel	325
Controlling the Delay via the OVERVIEW Screen	326
Controlling the Delay via the SELECTED CHANNEL VIEW Screen	327
SENDS TO	328
Using the Faders to Adjust the Sends (SENDS ON FADER Mode)	329
Port to Port HA function	330
Mix Minus	335
ST Mode and LCR Mode	336
Sending Signals to the STEREO Bus	337
About DCA	338
Assigning Channels to the DCA	339
Using DCAs	340
DCA Scene Grid (Theater Package Compatible)	341
About MUTE Groups	342
Temporary Unmute Function During Mute	343
Assigning Channels to a Mute Group	344
Channel Link	345
Types of Channel Links	346
Temporary Link	347
Temporarily Linking Channels	349
Copying Channel Parameters	350
Initializing Channel Parameters	351

DSP Resource Management for Premium / FX / GEQ Rack	352
GEQ/PEQ	353
Inserting a GEQ/PEQ into a Channel via the SELECTED CHANNEL VIEW Screen	354
About Plug-ins	355
Live Rec	361
About Automixer	362
AFC IMAGE control	364
AFC IMAGE settings	364

Other Operations 365

Storing a scene	365
Recalling a Scene	366
Deleting a Scene	367
Duplicating Scenes	368
Modifying the Scene Number and Title	369
Using the Focus Function	370
Using the Fade Function	372
Outputting a Control Signal to an External Device in Tandem with Scene Recall (GPI OUT)	373
Using the Global Paste Function	374
Using the Recall Safe Function	375
Saving Settings Data on a USB Drive	376
Loading a File from a USB Drive	377
Editing a File	378
Creating a Directory	379
Using the Monitor Function	380
Using the Cue Function	382
Using the Solo Function	384
Using the Oscillators	385
Using Talkback	386
Using PHONES	387

About Meter Area	388
Controlling the METER Screen	389
Assigning a Function to a User Defined Knob	393
The Functions that can be Assigned to User Defined Knobs	394
Assigning a Function to a User Defined Key	399
The Functions that can be Assigned to User Defined Keys	400
Setting a Custom Fader Bank	413
Using the Assist Function	414
Using Split Mode	418
Actor Library Setting Procedure (Theater Package Compatible)	422
About Dante	423
Configuring Dante Controller	424
Mounting an I/O DEVICE	425
Patching an I/O DEVICE	426
Using the manual and shortcuts	427
DM7 Editor	430
<hr/>	
About DM7 Editor	430
File Menu	431
Setup Menu	432
Window Menu	433
Help Menu	434
Editor Operation Overview	435
Operation during Editor Startup	436
Editor and Unit Synchronization	437
Editor's Offline Edit Function	438
Appendix	439
<hr/>	
FX Parameters	439
Premium Parameters	456

Appendix	468
General specifications	468
Audio characteristics	469
Analog input standards	472
Analog output standards	473
Digital I/O standards	474
Control I/O standards	475
Pin assignment table	476
Troubleshooting	477

Introduction

About the Product

Target users

This product is intended for users who can perform mixing operations on PA systems in halls, event spaces, studios, etc.

Purpose of use

This product is used for mixing at halls and event spaces and in broadcast/production.

About model differences

	Number of analog inputs	Monaural input channel	AES/EBU	Channel strip
DM7	32	120	4-in/4-out	Channel Strip section: 24 Main section: 4
DM7 Compact	16	72	0-in/2-out	Channel Strip section: 12 Main section: 4

DM7 Control (Expansion Controller)

The DM7 Control can be used to control functions for a number of applications, such as User Defined Keys and knobs, Scene Memory, Monitor Control, and Panner joystick.

NOTE

Illustrations are for the DM7 unless otherwise noted.

About Available Documentation

The DM7 Series manual can be downloaded from the Yamaha Pro Audio website in PDF format. The manual can also be viewed in HTML format.

<https://www.yamahaproaudio.com/>

■ Owner's Manual

This mainly provides explanations of the names of the various parts on the panel and their basic operation.

■ DM7 Series Reference Manual (this document)

This manual provides detailed explanations of all screens and functions, and includes step-by-step procedures and a system set-up procedure to help you operate the DM7 Series.

<https://manual.yamaha.com/pa/mixers/dm7/rm/>

■ DM7 Editor Installation Guide

This guide explains how to install the DM7 Editor.

<https://manual.yamaha.com/pa/mixers/dm7/ig/>

■ DM7 StageMix User Guide

This guide explains an iPad application that allows you to control the DM7 Series system wirelessly.

<https://manual.yamaha.com/pa/mixers/dm7/ug/>

About the Utility Software Configuration

The DM7 Series can be used with a variety of utility software. Detailed information about the software is available on the Yamaha Pro Audio website.

<https://www.yamahaproaudio.com/>

For information regarding how to download or install the software, as well as setting details, refer to the website listed above or to the downloaded Installation Guide.

■ **DM7 Editor**

This application software allows you to set up and operate the unit from a connected computer. You can also back up the unit settings, or set up the unit at a remote site where access to the unit is limited.

■ **DM7 StageMix**

This is software that allows remote operation of the main unit using an iPad.

■ **MonitorMix**

This application software allows you to remotely control the monitor mix balance of any DM7-series unit from a smart device connected via Wi-Fi.

■ **Console File Converter**

This application software allows you to convert settings file formats between the Yamaha RIVAGE PM series, CL series, QL series and DM7 Series.

■ **ProVisionaire Series**

This application software allows you to create a control panel that suits the setup environment or operational procedure, and to remotely control and monitor devices.

Firmware Updates

You can update the unit's firmware to improve the operability, add functions, and correct possible malfunctions.

Information on updating the firmware can be found on the following website.

<https://www.yamahaproaudio.com/>

For information on updating and setting up the unit, please refer to the firmware update guide available on the website.

Functional Enhancement Packages (Mixer Accessory)

Functional Enhancement Package for Broadcasting: Broadcast Package (DEK-DM7-BR)

The optional Broadcast Package/Theater Package allows you to add features suitable for broadcast and theater applications. Suitable for broadcast applications, the Broadcast Package adds features such as mix minus and loudness metering, and streamlines broadcast mixing with the DM7 Series.

Features:

- Mix minus
- Fader cue release
- Backstop PFL
- Audio Follow Video
- Source select mix mode
- Loudness meter
- Meter scale
- 5.1 Surround

Functional Enhancement Package for Theater Applications: Theater Package (DEK-DM7-TH)

The Theater Package, which is suitable for theater applications such as plays and musicals, adds functions such as an actor library, DCA scene grid, and AFC Image control, greatly improving the convenience of mixing for complex scenes and sound productions using the DM7 Series.

Features:

- 4-bank EQ/DYN
- Actor library
- DCA presets
- DCA scene grid
- MIDI Output Event on Scene
- AFC Image Control

Trademarks

- The illustrations and screenshots in this manual are entirely for the purpose of explanation.
- We bear no responsibility whatsoever for the effects or impacts of using the software or this manual.
- Windows is a registered trademark in the United States and other countries of Microsoft Corporation of the United States.
- Mac and iPad are trademarks of Apple Inc. registered in the United States and other countries.
- MIDI is a registered trademark of Association of Musical Electronics Industry (AMEI).
- Mackie Control and HUI are registered trademark or trademarks of LOUD Technologies Inc.
- The names and trade names in this manual are the registered trademarks or trademarks of the companies involved.
- The typefaces included herein are solely developed by DynaComware Taiwan Inc.
- TUXERA is a registered trademark of Tuxera Inc. in the US and other countries.

The logo for Tuxera Inc. features the word "TUXERA" in a bold, white, sans-serif font. The letters are set against a solid red rectangular background. The letter "A" has a distinctive horizontal stroke that tapers off to the right, giving it a dynamic, forward-leaning appearance.

Installation of Option Cards

Installation of PY cards

Before you install a PY card, you must check the Yamaha Pro Audio global website to see whether the DM7 Series supports your card.

<https://www.yamahaproaudio.com/>

1 Make sure that the power to this product is turned off.



CAUTION

Installing or removing a card while the power is on may lead to electric shock or component failure.

2 Remove the screws that fasten the [PY] card slot cover and remove the slot cover.

The removed screws will be used again to install the PY card. Keep the slot cover in a safe place for future use.

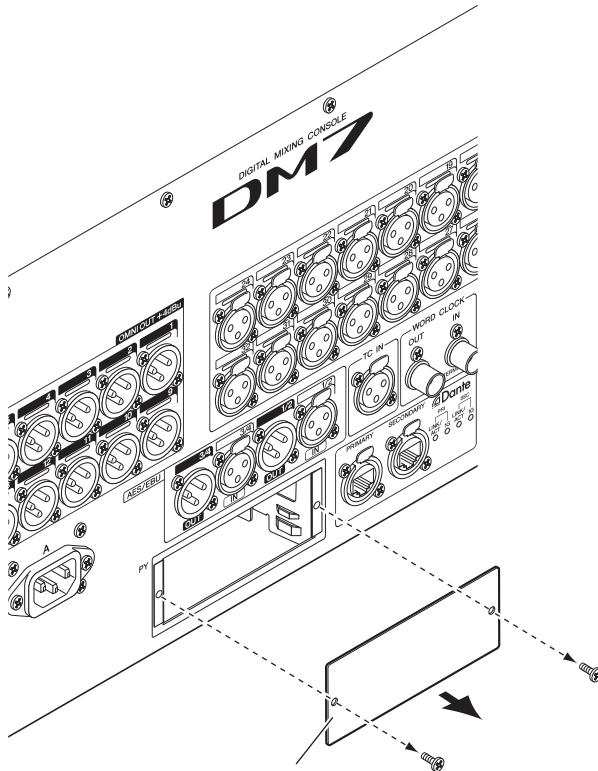

Removing the PY card

- 1 Make sure that the power to this product is turned off.**



CAUTION

Installing or removing a card while the power is on may lead to electric shock or component failure.

- 2 Completely loosen and remove the screws that hold the PY card in place.**
- 3 Pull the PY card toward you while holding the peg-shaped handles (see the figure below) on the card.**

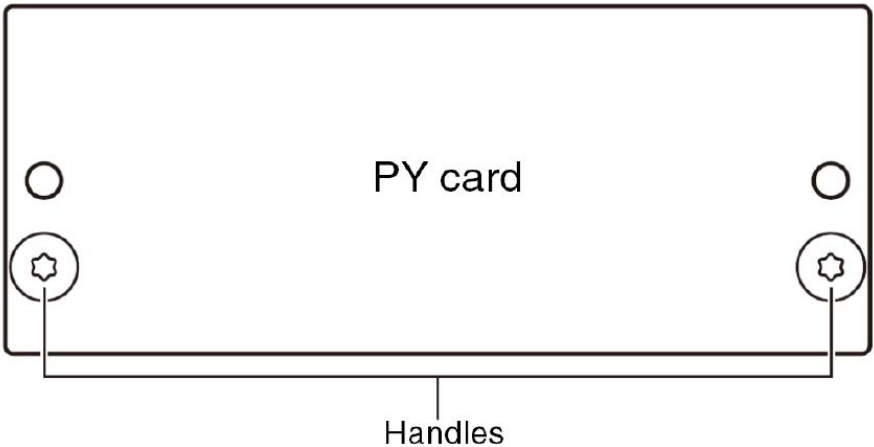

- 4 Replace the stored slot cover and affix it with the screws.**

Do not use the unit while the slot cover is removed. Component failure or malfunction may occur.

Connections

Analog input connections

The INPUT terminals on the DM7 Series and I/O devices are used primarily for connecting microphones and line-level devices.

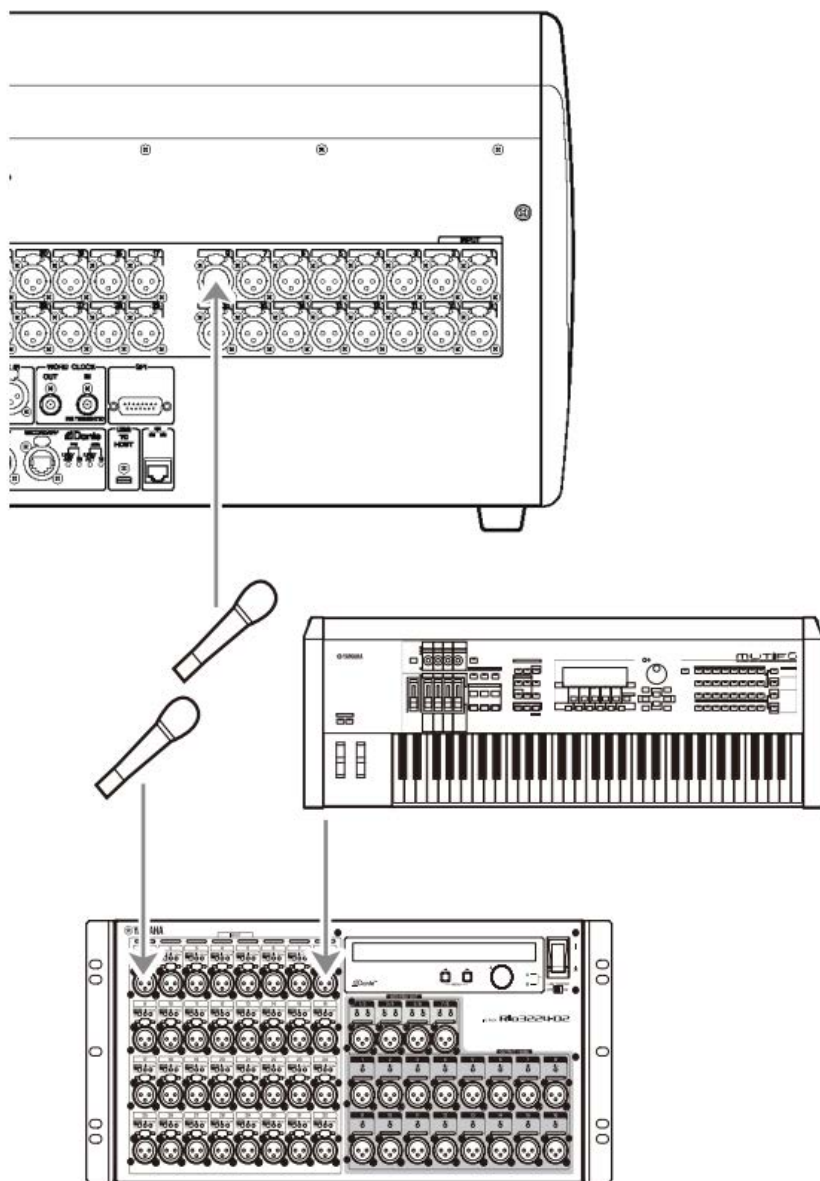

Rio3224-D2

The PATCH screen is used to set the switching of patches. Patches can also be switched using the PATCH button on the SELECTED CHANNEL VIEW screen.

Analog output connections

The OMNI OUT terminal on the DM7 Series and the OUTPUT terminals on the I/O devices can be used to patch output signals from output channels (MIX, MATRIX, STEREO (L/R)), monitor signals (MONITOR OUT L/R channels), and direct output signals from INPUT channels.

The front panel of the DM7 Series is equipped with a PHONES output jack for monitoring, enabling constant monitoring of the signal selected as the monitor source. The same signal can also be monitored through external speakers by assigning the MONITOR OUT L/R channels to any desired output terminal.

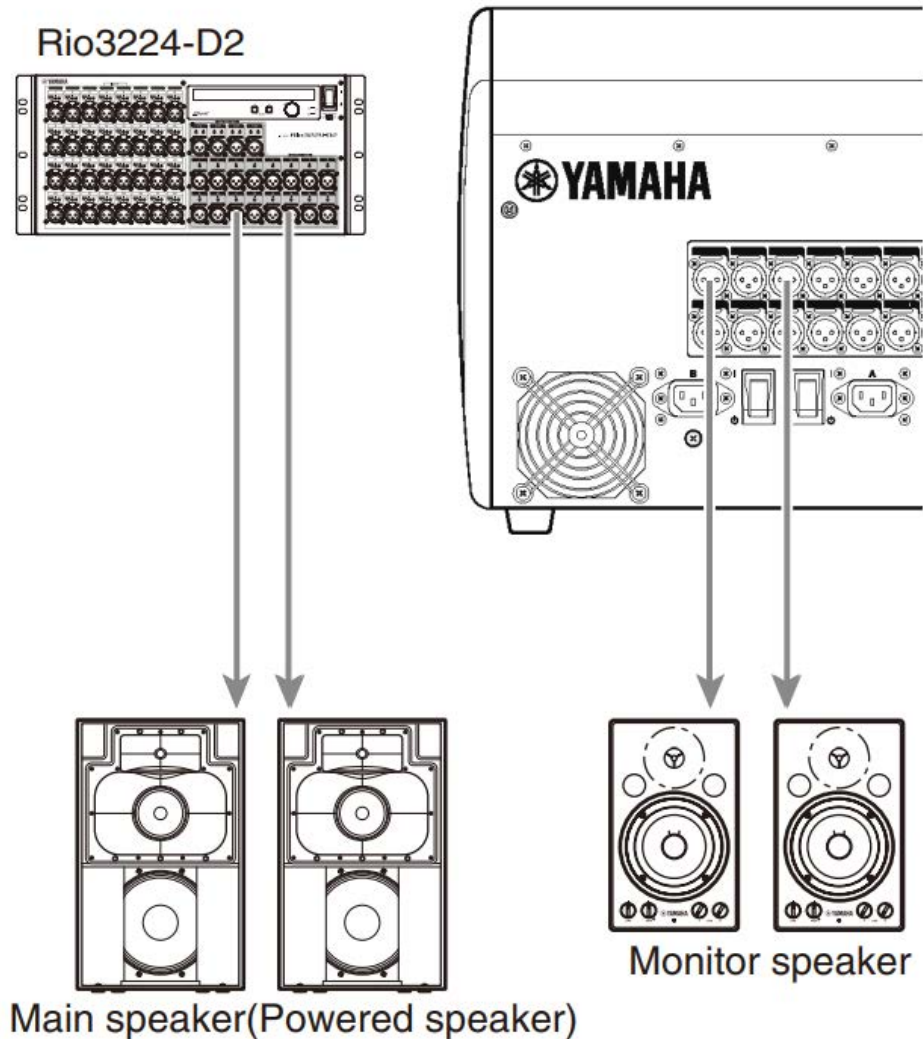

The PATCH screen is used to set the switching of patches. Patches can also be switched using the PATCH button on the SELECTED CHANNEL VIEW screen.

I/O device connections

When connecting the DM7 to I/O devices (Rio3224-D2, etc.) there are 2 options: daisy-chain connection and star connection.

In addition, devices equipped with two ports, one for the main circuit (PRIMARY) and the other for the secondary circuit (SECONDARY), can be redundantly connected to each other in the unlikely event of a failure.

Related links

- “About Dante” (p.423)
- “Daisy-chain connections” (p.26)
- “Star connections” (p.29)
- “Redundant connections” (p.32)

Daisy-chain connections

Daisy-chain connect devices by linking them together in a row. Building the network is easy and no network switches are required. It is used on simple systems when the number of devices to be connected is small.

As the number of connected devices increases, the latency must be increased. In addition, if the system fails due to a cable break or other cause, the network will be divided at that point and transmission to and from the devices beyond that point will not be possible.

■ Example of DM7 and I/O device connection

Use the Dante terminals on the DM7 and the I/O device and connect as shown below.

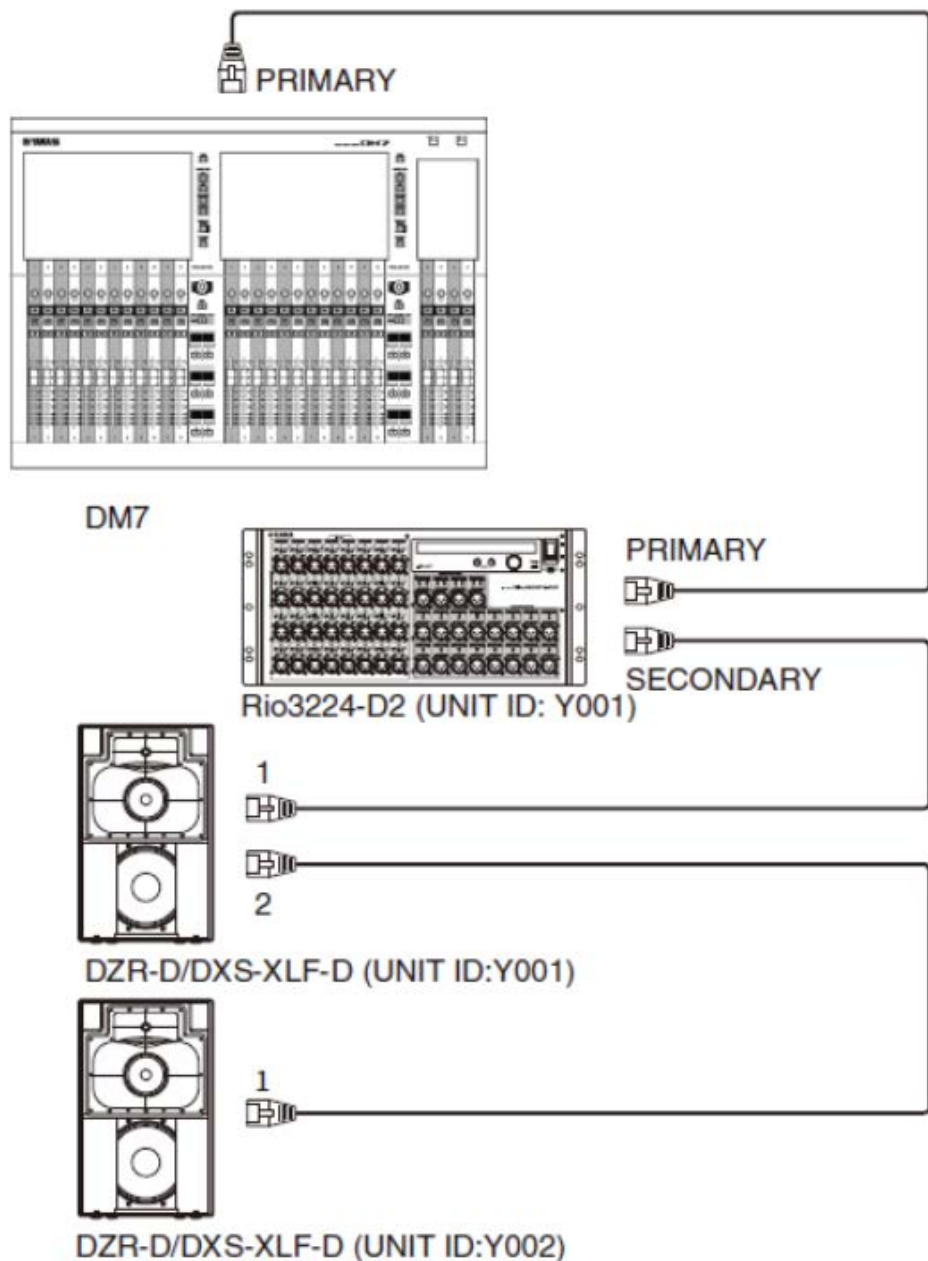

■ I/O device settings

Use the following settings when connecting the DM7 to Rio3224-D2 or DZR-D/DXS-XLF-D.

[Rio3224-D2 settings]

- UNIT ID = 1
- SECONDARY PORT = DAISY CHAIN
- START UP MODE = REFRESH

[DZR-D/DXS-XLF-D settings]

- UNIT ID = Desired ID
- MODE (DANTE MODE) = STANDARD

The UNIT ID for the DZR-D/DXS-XLF-D is set using the DANTE SETUP screen on the DZR-D/DXS-XLF-D unit.

[DM7 settings]

The Dante network settings are made using the Setup screen and the Device Mount screen in DANTE SETUP.

NOTE

The DZR Dante does not have the SECONDARY function.

Related links

- “DANTE SETUP (Setup) screen” (p.175)
- “DANTE SETUP (Device Mount) screen” (p.180)

Star connections

The star connection is a method of connecting devices centered around a network switch. A network switch that includes a variety of features to control/monitor the network (e.g., clock synchronization for any chosen data line, QoS to prioritize voice transmission, etc.) is recommended.

■ **Example of DM7 and I/O device connection**

Use the Dante terminals on the DM7 and the I/O device and connect as shown below.

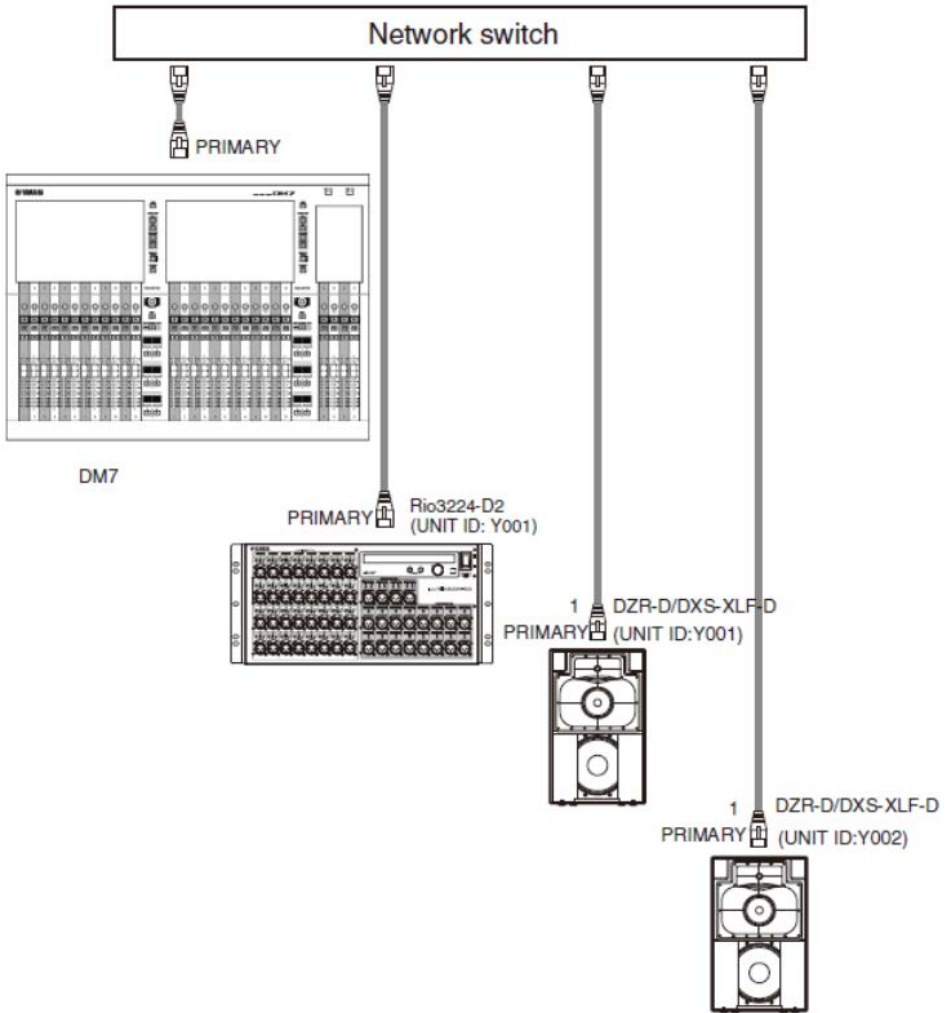

■ I/O device settings

Use the following settings when connecting the DM7 to Rio3224-D2 or DZR-D/DXS-XLF-D.

[Rio3224-D2 settings]

- UNIT ID = 1
- SECONDARY PORT = DAISY CHAIN

- START UP MODE = REFRESH

[DZR-D/DXS-XLF-D settings]

- UNIT ID = Desired ID
- MODE (DANTE MODE) = STANDARD

The UNIT ID for the DZR-D/DXS-XLF-D is set using the DANTE SETUP screen on the DZR-D/DXS-XLF-D unit.

[DM7 settings]

The Dante network settings are made using the Setup screen and the Device Mount screen in DANTE SETUP.

NOTE

The DZR Dante does not have the SECONDARY function.

Related links

- “DANTE SETUP (Setup) screen” (p.175)
- “DANTE SETUP (Device Mount) screen” (p.180)

Redundant connections

A redundant connection is a network consisting of two circuits, a primary circuit (PRIMARY) and a secondary circuit (SECONDARY). Normally, communication is performed on the PRIMARY circuit but in the event of a disconnection or other problem on the PRIMARY circuit, communication is automatically switched to the SECONDARY circuit. When using a star connection, this method creates an environment that is more resilient to network failures than a daisy-chain network.

■ Example of DM7 and I/O device connection

Use the Dante terminals on the DM7 and the I/O device and connect as shown below.

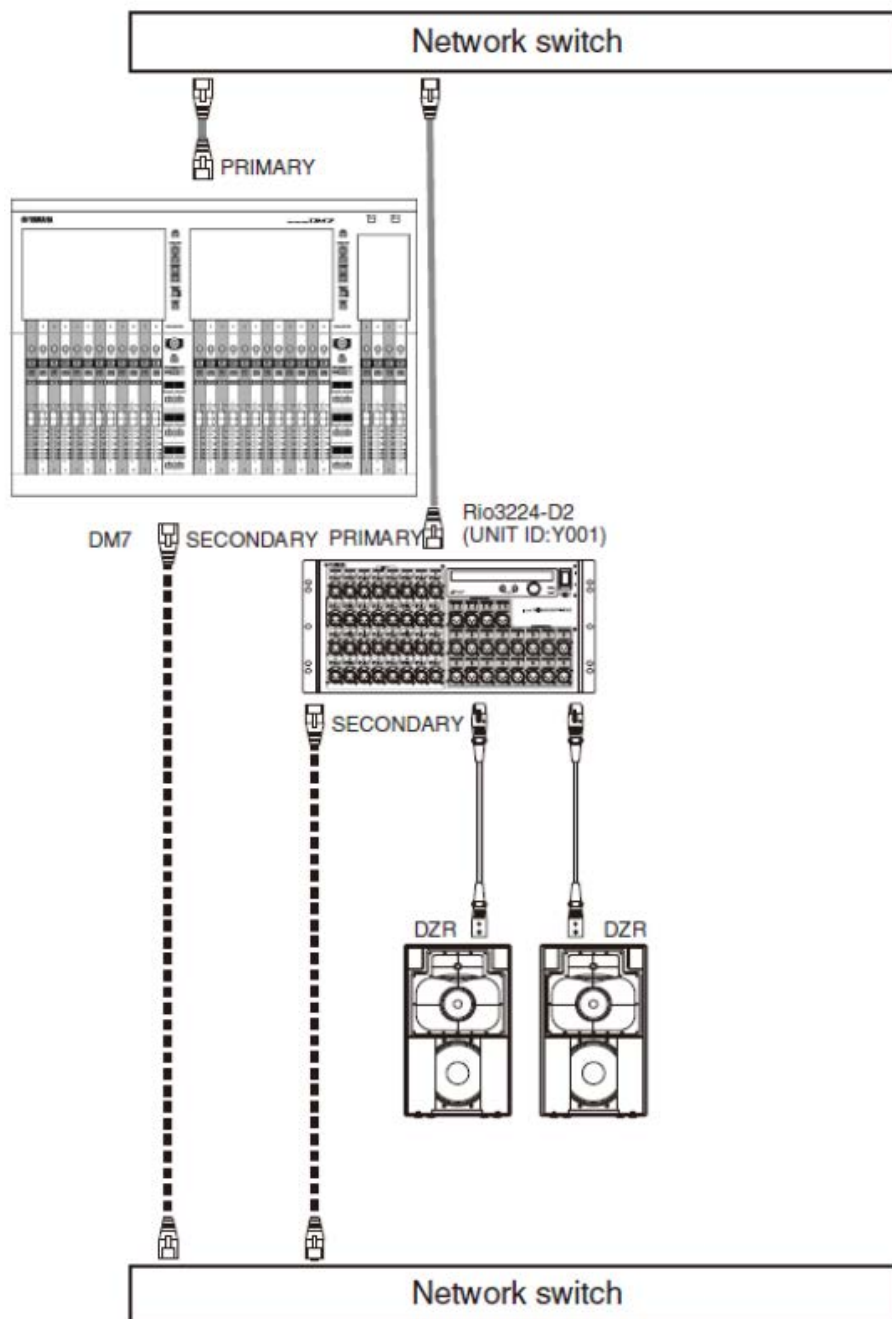

■ I/O device settings

Use the following settings when connecting the DM7 to a Rio3224-D2.

[Rio3224-D2 settings]

- UNIT ID = 1
- SECONDARY PORT = REDUNDANT
- START UP MODE = REFRESH

[DM7 settings]

The Dante network settings are made using the Setup screen and the Device Mount screen in DANTE SETUP.

Related links

- “DANTE SETUP (Setup) screen” (p.175)
- “DANTE SETUP (Device Mount) screen” (p.180)

Connecting to the DM7 Console (DM7 Control)

Use the upper displays and encoders in [USER DEFINED KNOBS] for the following operations.

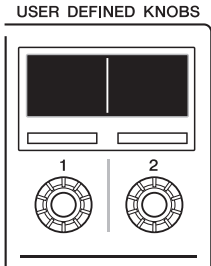

Encoder [1]: Press to cancel or back out of a menu or screen.

Encoder [2]: Turn to the right to advance through a menu or screen, and turn to the left to go back. Press to execute or select.

Press encoders [1] and [2] at the same time to enter the Menu screen.

You can set the items in the following table on the Menu screen.

Setting	Parameter1	Parameter2	Parameter3	Explanation
Version				Displays the firmware version.
Connection	Clear Last Target			Selects a connection destination.
	Direct IP			
Network	Network Mode	Static IP		Configure a network.
		DHCP		
	IP Address			
	Subnet Mask			
	Default Gateway			
Setting	Contrast	Mini LCD	0-10	Sets the screen's contrast and brightness.
	Brightness	Mini LCD	0-15	
		Color Bar	0-15	
		Panel	0-15	
		Light	0-15	
	Color	Light	0-10	
	Others	Fan Speed	LOW/HIGH	Sets the cooling fan's speed.
Maintenance	Fader Calibration			Performs Fader and Joy Stick calibration.
	Stick Calibration			

License				Displays license information.
Log				Displays the log.

For new connections

1 Configure a network.

For a new connection, start the product and go to the Menu screen. From the Menu screen, go to the Network screen.

■ When using DHCP

Select DHCP for the Mode on the Network screen.

■ When using a Static IP

Select Static IP for the Mode on the Network screen. After setting the IP Address, advance the screen and set the Subnet Mask and Default Gateway correctly.

2 Connect the DM7 console.

From the Menu screen, proceed to the Connection screen.

■ When selecting a detected DM7 console

On the Connection screen, turn encoder [2] to the right to display the detected DM7 console, and select the connection destination.

■ When directly specifying the IP address of the connection destination

From the Connection screen, proceed to the Direct IP screen and enter the IP address.

NOTICE

- DM7 Control may update automatically when a new connection is made. Wait until the update finishes without turning off the power.

If the connection settings have already been made

If a DM7 console existing on the same network is detected, it will automatically connect. If it does not connect automatically, follow the procedure for a new connection.

NOTE

If you want to enter the Menu screen when connection settings have already been made, press [USER DEFINED KNOBS] encoders [1] and [2] at the same time.

Part Names & Functions

Top Panel

This will explain the functions and names of the components on the top panel of the DM7 Series.

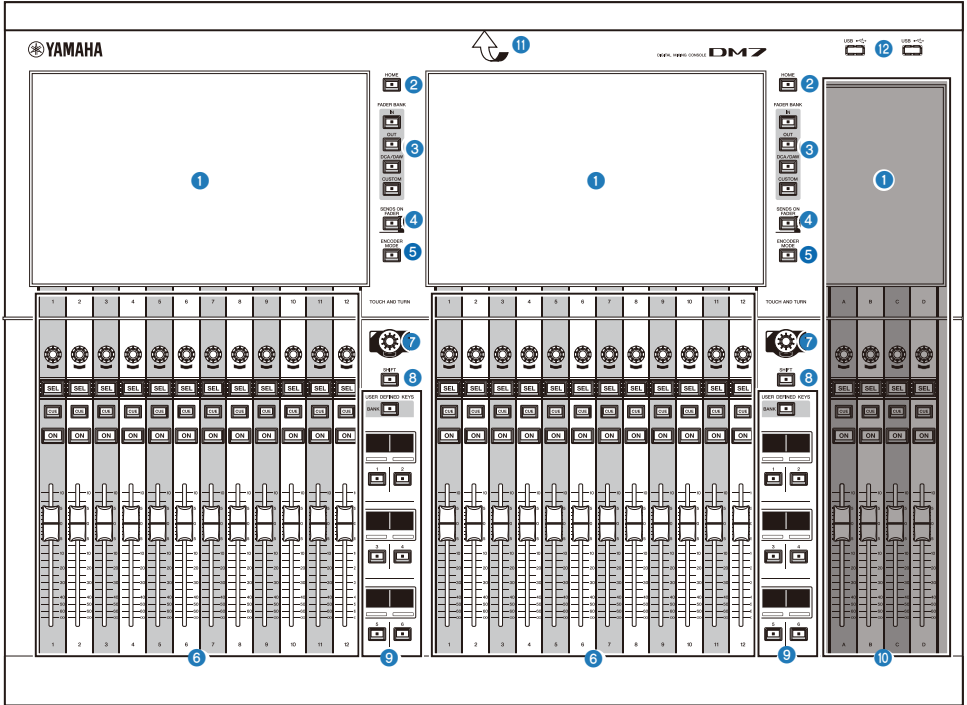

1 Touch screen

These are capacitive multi-touch screens. The unit will not work properly if operated when wearing gloves.

NOTICE

- Do not operate the screen with sharp-pointed objects or fingernails. It may damage the screen or make it impossible to operate the touchscreen.

NOTE

A clear protective film is installed on the touchscreen at the factory, please remove before use.

2 [HOME]

Recalls and toggles between the OVERVIEW and SELECTED CHANNEL VIEW screens.

3 [FADER BANK]

Switches fader assignments on the panel.

4 [SENDS ON FADER]

Turns SENDS ON FADER mode on/off. When this mode is turned on, you can use the channel strips to adjust the send level of signals sent to the MIX/MATRIX bus.

5 [ENCODER MODE]

Use these keys to display the screen on the corresponding Bay screen to switch between functions for the encoders located below the touch screen. These encoders feature the following two functions:

Screen Encoder function:

Up to 12 parameters can be assigned to the encoders via the touch screen.

Channel Encoder function:

Parameters for 12 channels on the channel strips can be assigned to the encoders.

6 Channel Strip section

Controls the main parameters for the currently-selected channels.

7 [TOUCH AND TURN]

Controls the parameter of the knob selected via the touch screens.

8 [SHIFT]

Combine with another key to perform certain functions.

9 [USER DEFINED KEYS]

Operates a pre-assigned function.

In addition, this switches the bank to be operated via [BANK] as the Fader Bank.

10 Main Section

This section allows you to adjust main parameters for the assigned channels. By default, STEREO A and STEREO B are assigned to channel C and D respectively.

NOTE

The areas in the diagram below are called Bay L (DM7 only) and Bay C.

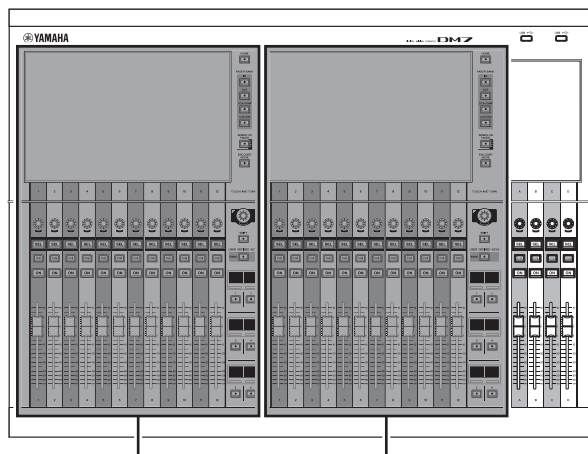

Bay L (DM7 only)

Bay C

11 LED lighting bar

Illuminates the operation panel when using in a dark location.

12 USB port

This port is used to connect USB drives.

■ USB drive format

The supported format types are FAT16 and FAT32 and exFAT.

■ Write protection

Some USB drives can be write-protected to prevent accidental deletion of data. If your USB drive contains important data, we suggest that you use write protection to prevent accidental erasure. On the other hand, you will need to make sure that your USB drive's write-protect setting is turned off before you save data to it.

For information about USB drives that can be used with the system, visit the Yamaha Pro Audio website at:

<http://www.yamahaproaudio.com/>

NOTICE

- Do not remove the USB drive from the USB port or turn off the power to the unit while the unit is accessing data, e.g., saving, loading or deleting data. Doing so may damage your drive, or may damage the data in the unit or on the media device.

Rear Panel

This will explain the functions and names of the components on the rear panel of the DM7 Series.

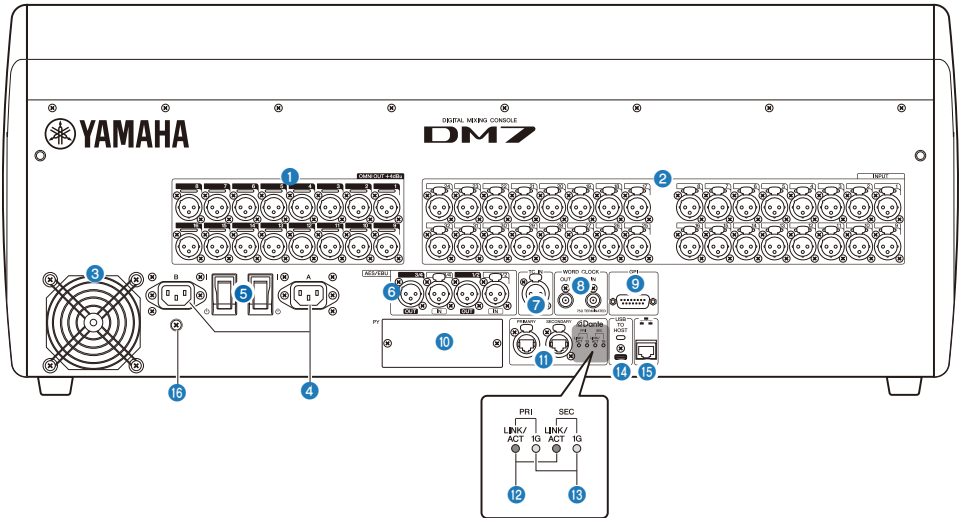

1 [OMNI OUT]

Balanced XLR 3-pin chassis output connectors for analog audio signals.

2 [INPUT]

Balanced XLR 3-hole chassis input connectors for analog audio signals from line-level devices or microphones.

3 Exhaust vent

This product is equipped with a cooling fan. This vent lets warm air escape from the unit. Make sure that the vent is not blocked with obstructions or other objects. Intake air is provided through vents on the lower front and rear sides.



CAUTION

- Do not block the ventilation ports (heat dissipating slits) on this product. To prevent increased internal temperature, there are ventilation holes on the front and rear of the product. If the ventilation ports are blocked, heat will be trapped inside the product, which may cause malfunction or fire.

4 **AC IN connectors [A]/[B]**

Connects to the supplied power cords. Connect the power cords to this unit, then connect the plug ends into the outlet. When connecting the power cords, insert all the way until they lock in place securely. The supplied AC power cords feature a V-lock mechanism with a latch, which prevents the power cords from disconnecting accidentally.



CAUTION

- Ensure that the power to the unit is turned off before connecting or disconnecting the power cord.

To disconnect a power cord, remove it while pressing the latch on the plug.

5 **[|]/[⏻] (Power switch)**

Toggles the power between ON (|) and OFF (⏻). If the unit will not be used for a long time, be sure to remove the power cord from the AC outlet.

When the switch is (⏻), the power is off.

NOTICE

- Turning the unit on/off in rapid succession can cause it to malfunction. After turning the unit off, wait at least six seconds before turning it on again.

NOTE

This product will operate normally when one or both power supplies [A] and [B] are on. If both power supplies are on and one of the power supplies fails during operation, the unit automatically switches to the other power supply.

6 **[AES/EBU]**

The DM7 is equipped with a sampling rate converter on both the [IN] and [OUT] chassis connectors. Please note that the DM7 Compact, which features only the [OUT] chassis connectors, is not equipped with a sampling rate converter.

[IN] (DM7 only)

These are balanced XLR 3-hole chassis input connectors that accept digital audio signals in the AES/EBU format.

[OUT]

These are balanced XLR 3-pin chassis output connectors for outputting digital audio signals in the AES/EBU format.

7 **[TC IN]**

This balanced XLR 3-hole chassis input connectors accepts time code signals from the connected external device.

8 **[WORD CLOCK OUT/IN]**

These are BNC connectors used to transmit/receive word clock signals to/from an external device. The [WORD CLOCK IN] connector is internally terminated by a 75-ohm resistor.

9 [GPI]

This is a D-sub 15-hole chassis connector that allows communication (5-in/5-out) with a GPI-compatible external device.

10 [PY]

This card slot allows you to install a PY card (sold separately) to expand the number of I/O ports.

11 Dante [PRIMARY]/[SECONDARY]

These terminals are used to connect to I/O devices such as the Rio3224-D2 to a Dante audio network. Use RJ-45 connectors that are compatible with Neutrik etherCON CAT5e connectors.

NOTICE

- Use an STP (Shielded Twisted Pair) cable to prevent electromagnetic interference. Make sure that the metal components of the connectors are electrically connected to the STP cable's shield by conductive tape or other similar methods.

Do not use the network switch's EEE function(*) within a Dante network. Although power management should be negotiated automatically in switches that support EEE, some switches do not perform the negotiation properly. This may cause EEE to be enabled in the Dante network when it is not appropriate, resulting in poor synchronization performance and occasional dropouts. Therefore, we strongly recommend that:

- When using a managed switch, turn off the EEE function on all ports used for Dante. Do not use switches that cannot turn off the EEE function.
- When using unmanaged switches, do not use switches that support the EEE function. The EEE function cannot be turned off on these switches.

*The EEE (Energy Efficient Ethernet) function is a technology that reduces switch power consumption during periods of low network traffic. It is also known as Green Ethernet or IEEE802.3az.

12 [LINK/ACT]

[PRIMARY] and [SECONDARY] indicators show the respective communication status. If the Ethernet cables are connected properly, the indicators will flash rapidly.

13 [1G]

These indicators light up when the Dante network is functioning as Gigabit Ethernet.

14 [USB TO HOST]

This is a USB Type-C (USB2.0) port.

By connecting a computer with a USB cable, the console can function as a 96 kHz/32-bit or 48 kHz/32-bit audio interface with a maximum of 18 inputs and 18 outputs. It also allows you to use USB-MIDI to control a DM7 Series unit and remotely control DAW software.

The Yamaha Steinberg USB Driver must be installed to communicate with the computer.

NOTICE

- Use USB cables less than 3 meters in length.
- Leave an interval of at least 6 seconds between plugging and unplugging the USB cable.

15 Network connector

This RJ-45 connector allows the unit to be connected to a computer via an Ethernet cable (CAT5 or higher recommended).

NOTICE

- Use an STP (Shielded Twisted Pair) cable to prevent electromagnetic interference.

16 Grounding screw

Each supplied power cord has a three-prong plug. If the AC outlets are grounded, this product will be properly grounded through the power cords. Also, grounding this screw may effectively eliminate noise such as hum and interference.

Front Panel

This will explain the functions and names of the components on the front panel of the DM7 Series.

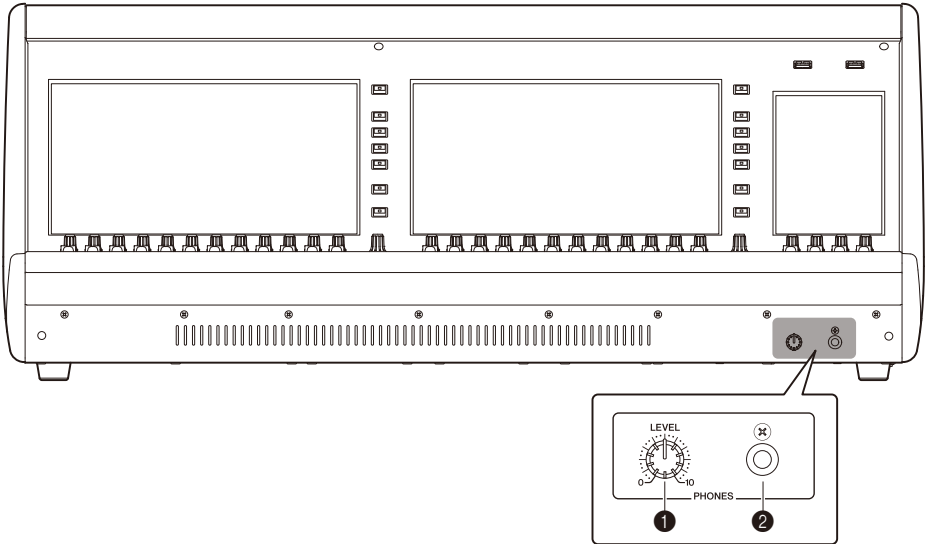

1 [PHONES LEVEL]

This adjusts the level of the signal output from the PHONES OUT socket.

2 [PHONES]

This is a headphone socket for monitoring the MONITOR or CUE signals.

Part Names & Functions(DM7 Control)

Top Panel

This will explain the functions and names of the components on the top panel of the DM7 Series.

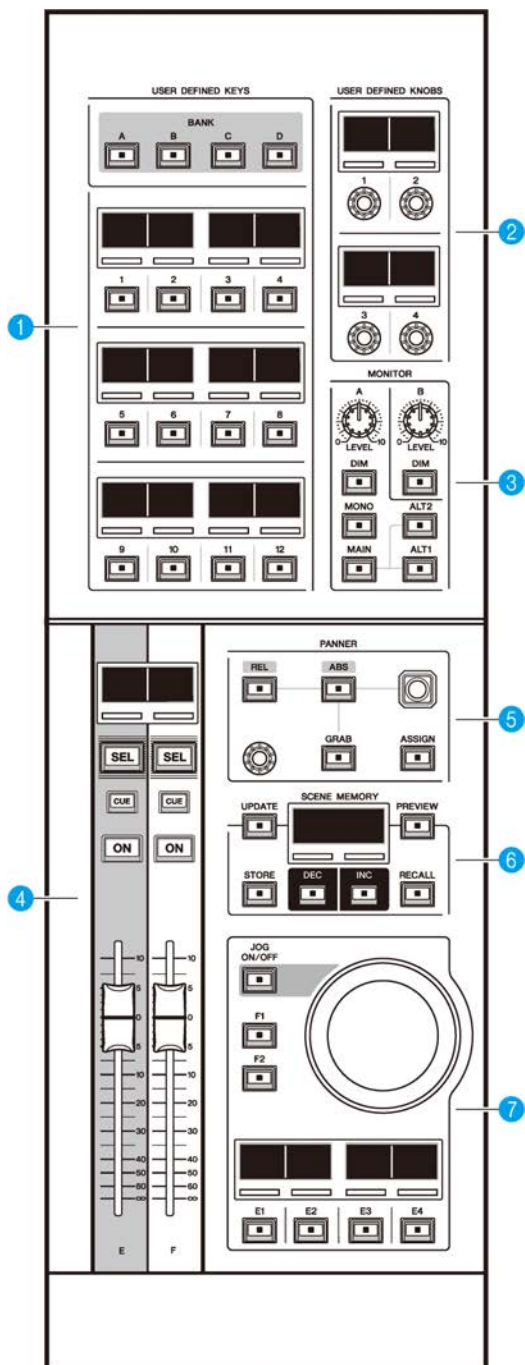

1 [USER DEFINED KEYS]

This section enables you to control the assigned functions. Use the [BANK] keys to switch banks. Assign functions from the DM7 console screen.

2 [USER DEFINED KNOBS]

This section enables you to control the assigned functions. You can assign four functions to these knobs. They are not organized into banks. Assign functions from the DM7 console screen

3 [MONITOR]

In this section, use the [LEVEL A] or [LEVEL B] knob to adjust the output level of the monitoring signals. In addition, these knobs enable you to operate the DIMMER function when you turn on the corresponding [DIM] key. In the Monitor A subsection, press the [MONO] key to switch Out Mode to MONO. To switch among the Output monitoring sources, use the [MAIN], [ALT1], and [ALT2] keys.

4 Channel Strip section

In this section, you can control the CUSTOM FADER channel strips for channels E and F assigned on the DM7 console.

5 [PANNER]

This section enables you to control the PANNER function. Use the joystick to control the PANNER in the X-Y direction, and use the encoder to control the PANNER in the Z direction. You can assign the function that you wish to operate to the encoder. Use the [REL] and [ABS] keys to switch between relative and absolute values for distance. Press the [GRAB] key to immediately apply the PANNER position. In addition, use the [ASSIGN] key to display the screen (that is linked to the PANNER function) on the DM7 console.

6 [SCENE MEMORY]

This section enables you to control scene memories. The currently-selected scene memory number appears on the SCENE MEMORY display.

7 Jog Wheel section

This section enables you to use the jog wheel, and keys [F1], [F2], or [E1] through [E4] to control the function that is assigned in advance. The name of the function assigned to keys [E1] through [E4] appears in the corresponding small displays. Assign functions from the DM7 console screen.

Rear Panel

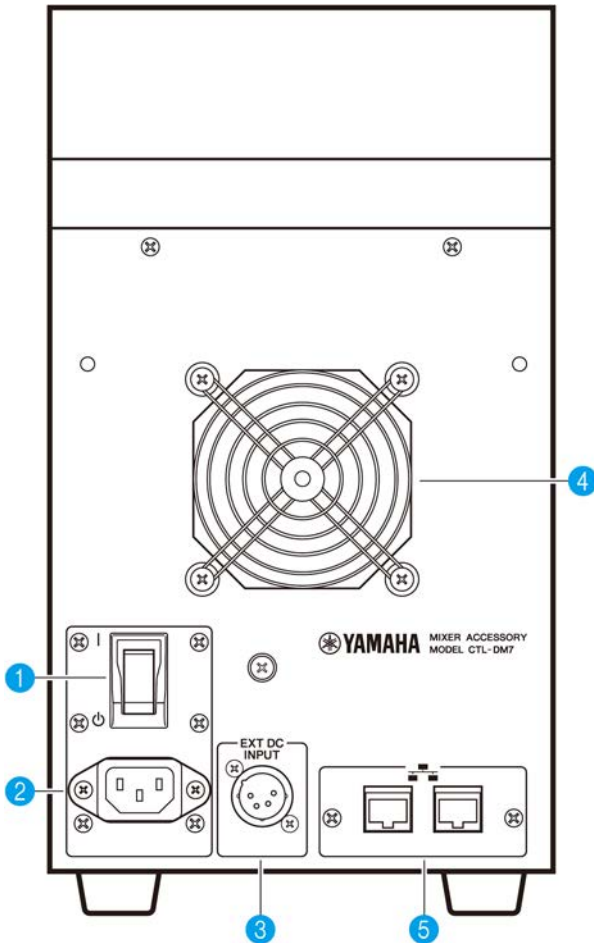

1 [I]/[O] (Power switch)

Toggles the power between on (I) and off (O). If the unit will not be used for a long time, be sure to remove the power cord from the AC outlet.

When the switch is (O), the power is off.

NOTICE

- Turning the unit on/off in rapid succession can cause it to malfunction. After turning the unit off, wait at least six seconds before turning it on again.

2 AC IN connector

Use this socket to connect the supplied power cord. First connect the AC power cord to this unit, and then insert the power cord plug into an AC outlet. Insert the cord plug all the way until it locks in place securely. The supplied AC power cord features a V-lock latch mechanism, which prevents the power cord from disconnecting accidentally.



CAUTION

- Be sure to turn off the power to the unit before connecting or disconnecting the power cord.

To disconnect a power cord, remove it while pressing the latch on the plug.

3 [EXT DC INPUT]

This is an XLR 4-pin chassis connector that provides external power supply (DC 24 V) as a backup for the internal power supply of this product. For this connector, use the Yamaha PA-700 AC Adaptor or an equivalent item recommended by Yamaha. To connect the AC adaptor, first connect the AC adaptor cord to the AC adaptor, and then insert the DC plug into this connector. Finally, insert the power cord plug into an AC outlet.



CAUTION

- Be sure to turn off the power to the external power supply before connecting it. Otherwise, component failure or electric shock may occur.
- For the [EXT DC INPUT] connector, be sure to use a power supply rated at DC 24 V that satisfies LPS (Limited Power Source) requirements.

NOTE

- You cannot use the power switch on this product to turn the power to the product on or off if an external power supply is connected.
- This product will operate normally when either one or both of the internal and external power supplies are turned on.
- If both power supplies are turned on and then one of the power supplies fails during operation, the unit will continue to operate normally.

4 **Cooling vent**

This product is equipped with a cooling fan. This vent lets warm air escape from the unit. Make sure that you do not block the vent with any object. The air is taken in through the ventilation ports under the front.



CAUTION

- Do not block the ventilation ports (heat dissipating slits) on this product. To prevent increased internal temperature, there are ventilation holes on the front and rear of the product. If the ventilation ports are blocked, heat will be trapped inside the product, which may cause malfunction or fire.

5 **Network connectors**

These RJ-45 connectors allow the unit to be connected to a computer via an Ethernet cable (CAT5e or higher recommended). In this way, you can control the unit externally from supported application software, such as DM7 Editor. Since the L2 switch is built in, you can set up this product to share and link functions with the DM7 console by connecting one of these connectors to the DM7 console and the other to a computer. These connectors do not support a redundant connection.

NOTICE

- Use an STP (Shielded Twisted Pair) cable to prevent electromagnetic interference.

Basic Operations

Basic Operations on the Top Panel

This section explains the basic operations that are performed on the top panel.

Bay encoder operations

The [ENCODER MODE] key is used to switch between functions.

Screen encoder

Up to 12 parameters can be controlled using the touchscreen.

Channel encoder

This controls the assigned parameters for the 12 channels lined up in the channel strips.

[TOUCH AND TURN] knob operation

Press the parameter you want to control on the touchscreen and use the [TOUCH AND TURN] knob to immediately control it. At this time, a pink frame will appear over the parameters that can be controlled on the touchscreen.

Basic Screen Operations

Switching screens



On the bay screen, when the  in the upper right is pressed, the menu bar is displayed. Press the desired button on the menu bar to switch to the corresponding screen. In the Utility screen, press the desired button on the HOME screen to switch to the corresponding screen. When the HOME button is pressed, you will return to the HOME screen.

NOTE

On the screen, the area with a pink frame when selected contains the parameters that can be controlled with the [TOUCH AND TURN] knob.

Controlling parameters with the [TOUCH AND TURN] knob

After selecting the parameter to be controlled by tapping on it, use the [TOUCH AND TURN] knob to perform operations. A pink frame appears around the selected parameter.

Setting parameter values on the screen

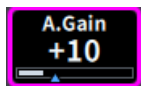

After selecting the parameter to be controlled by tapping on it, use the vertical or horizontal slider to set the parameter value. A pink frame appears around the selected parameter.

Scrolling

On screens that feature a scroll bar, slide your finger up and down or left and right to scroll the screen. Swiping the screen allows you to scroll quickly. You can also manipulate the screen as follows:

- Pinching or spreading fingers
The EQ's Q can be controlled.
- Sliding three fingers up and down
The amount of cut/boost of EQ gain for multiple bands can be adjusted simultaneously.
- Sliding four fingers up and down / Pinching or spreading three fingers in and out
The amount of EQ gain for multiple bands can be increased or decreased all at once.

On-screen User Interface

This section explains various user interface components shown in the touch screens, and how to use them.

Tabs

Tabs are used when switching between multiple pages. The page name is displayed on the tab.

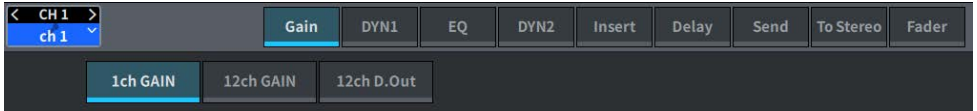

Buttons

Buttons are used to execute specific functions, to switch parameters on/off, or to select one of multiple choices. Buttons that perform on/off operations appear in solid colors while they are turned on, and are dark when turned off.



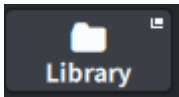

When you press the  button, a separate popup window will open, allowing you to make detailed settings.

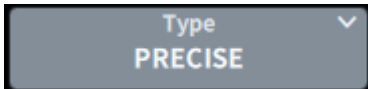

When you press the  button, a pull-down menu will appear.



When you press the expand  button or collapse  button, windows such as the EQ or dynamic will expand or collapse.

List screens

Windows similar to the following are displayed to allow you to select items from a list, such as the USER DEFINED knob setting window.

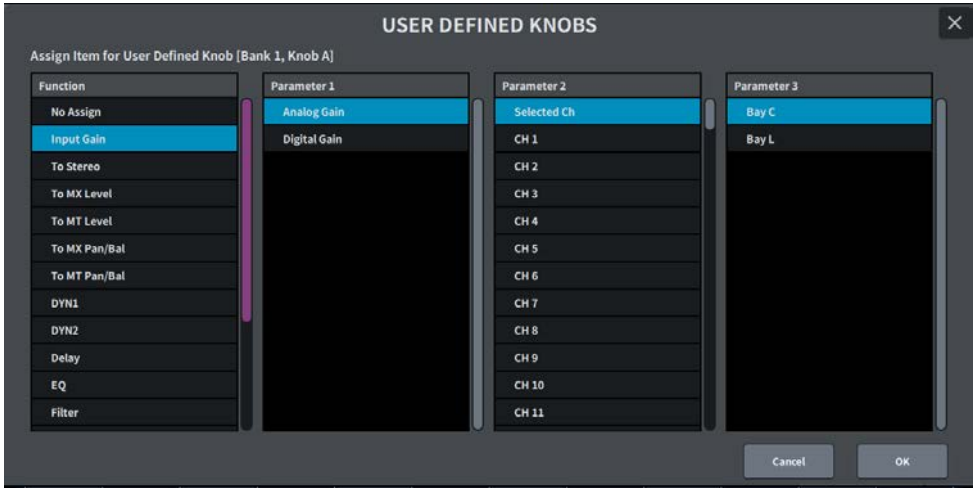

The blue item in the list is the item that is selected for operation. Use the [TOUCH AND TURN] knob to scroll up and down the list.

Keyboard screen

The following keyboard window will appear when you need to assign a name or comment to a scene or library, or when you need to assign a channel name. Press the character buttons on the screen to enter the desired characters.



Dialog boxes

Dialog boxes similar to the following allow you to confirm operations you just performed. Press the OK button to execute the operation. The operation will be canceled if you press the CANCEL button.



Screen Overview

Tool Bar

The toolbar has icons for frequently used functions and screens for system settings. The toolbar is always visible, even when the main area display has been switched.



- 1 Displays the “SCENE Screen” (p.81) .
- 2 Displays the “Controlling the METER Screen” (p.389) .
- 3 Displays the “PATCH Screen” (p.167) .
- 4 Displays the “RACK Screen” (p.247) .

5



Displays the menu bar.

Press to open a pull-down menu to access each function.

About the SELECTED CHANNEL VIEW Screen



This screen shows all mix parameters of the currently-selected channel.

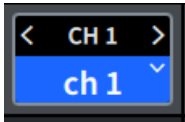

1 Selected channel

This area shows the number, name, icon, and channel color of the channel that is currently selected for operation. Press < to switch to the previous channel and > to switch to the next channel. Press ∨ to display a list of channels and you can switch to any channel.



2 Input Select button

Press to open the Input Select screen, where you can switch between Input A and B and change the patches.

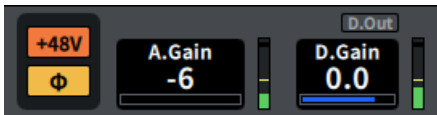

3 HA indicator

Displays the on/off status of the HA's phantom power (+48V) and the input phase. When pressed, a popup screen is displayed that allows you to turn the phantom power on/off and switch between forward (gray) or reverse (orange) phase.

4 A.Gain

Displays the HA analog gain. If the Gain Compensation function is turned on, a blue indicator appears, showing the analog gain position at the time the function was turned on. The level immediately after the analog HA is displayed on the right. When the screen is pressed to select, the value can be changed by sliding vertically or horizontally or using the [TOUCH AND TURN] knob; the Gain screen is displayed by pressing it again.

5 D.Gain

Displays the digital gain setting value. The on/off status of the Direct Out is displayed in the upper area. When the screen is pressed to select, the value can be changed by sliding vertically or horizontally or using the [TOUCH AND TURN] knob; the Gain screen is displayed by pressing it again.

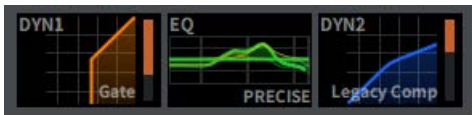

6 Switches between the expanded display and collapsed display of DYN1.

7 Switches between the expanded display and collapsed display of EQ. If you touch and hold EQ or DYN2 and slide to the side, the order of EQ and DYN2 will be switched.

8 Switches between the expanded display and collapsed display of DYN2.

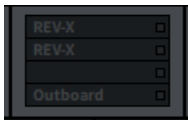

9 Press this to display the screen for effects and inserts.

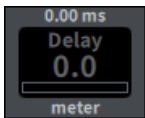

10 Delay

Displays the delay time. When the screen is pressed to select, the value can be changed by sliding vertically or horizontally or using the [TOUCH AND TURN] knob; the Delay screen is displayed by pressing it again.

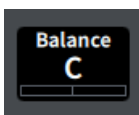

11 Pan/Balance

Displays the signal location. When the screen is pressed to select, the value can be changed by sliding vertically or horizontally or using the [TOUCH AND TURN] knob; the To Stereo screen is displayed by pressing it again.



12 ST A/B

Displays the on/off for signals sent to the STEREO A bus and B bus. Press to display the popup window used to switch on/off.



13 Fader

Displays the fader level. When the screen is pressed to select, the value can be changed by sliding vertically or horizontally or using the [TOUCH AND TURN] knob; the Fader screen is displayed by pressing it again.



14 ON/CUE

The channel and cue out on/off and the selected cue bus are displayed. Press to display the pop-up window used to switch on/off.

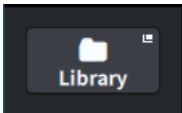

15 Opens the “CH LIBRARY Screen” (p.273) .

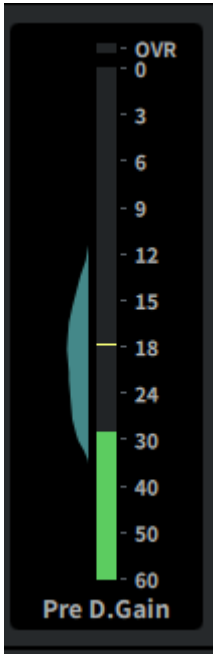

16 LEVEL meter

The signal level set in the channel Metering Point is displayed.

When A.Gain is present and the Metering Point is Pre GC or Pre D.Gain, the input level distribution is displayed next to the meter as a histogram. The width is displayed thicker as the levels being observed in an area increases.

When pressed, a popup screen is displayed to switch Metering Point, turn Peak Hold on/off, and reset the histogram.



17 Pair setting popup button

When pressed, the screen used for CHANNEL PAIRING is displayed.

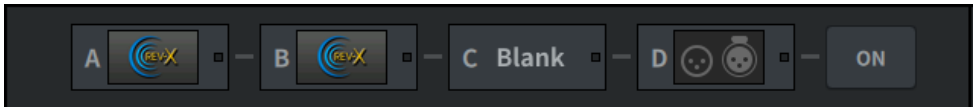

18 Insert button

Press this to display the screen for effects and inserts.



19 Automixer button

Opens the “AUTOMIXER Screen” (p.77) .

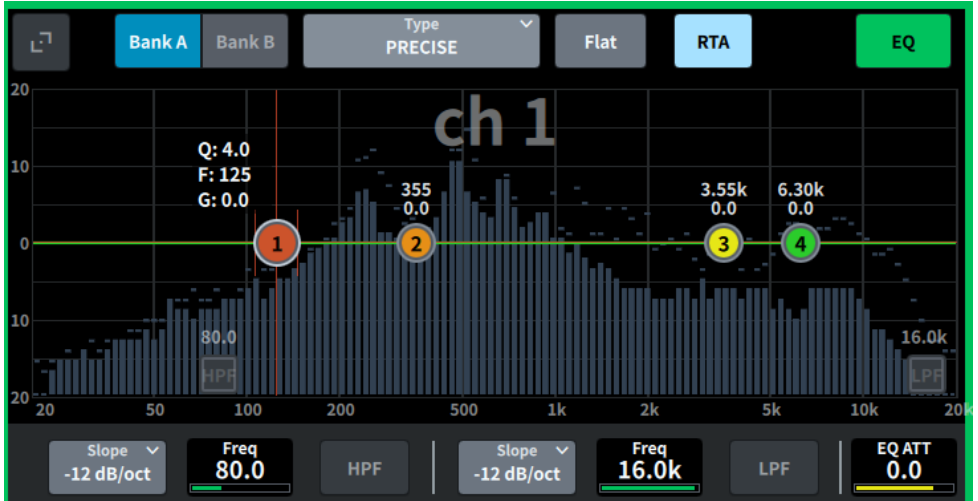

20 EQ

Displays the EQ graph, bank, type, HPF, LPF, EQ ATT, etc. Pressing this field displays the parameter name and value, and they can be adjusted using the screen encoder. Pressing the expand button displays the EQ screen.

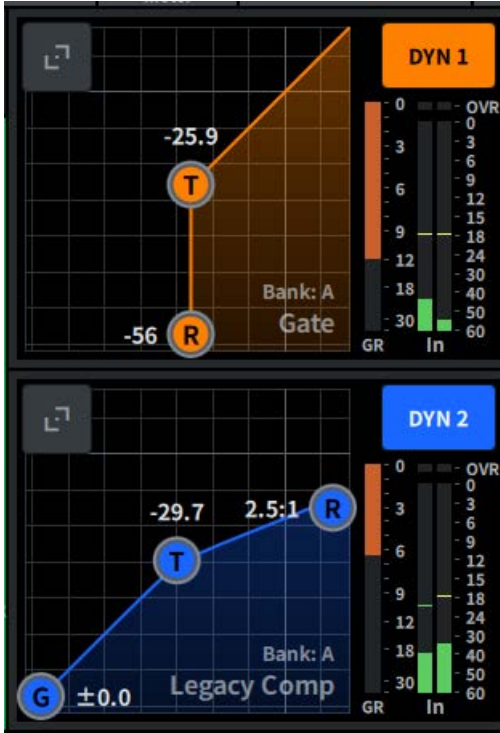

21 DYN1

Displays the selected dynamics type, threshold value, input/output frequency response graph, GR (gain reduction) meter, and input/output level indicators for Dynamics 1. Pressing this field displays the parameter name and value in the upper portion of the channel name area, and they can be adjusted using the screen encoder. Pressing the expand button displays the DYN1 screen.

22 DYN2

Displays the selected dynamics type, threshold value, input/output frequency response graph, GR (gain reduction) meter, and input/output level indicators for Dynamics 2. Pressing this field displays the parameter name and value in the upper portion of the channel name area, and they can be adjusted using the screen encoder. Pressing the expand button displays the DYN2 screen.



23 MIX/MATRIX Sends

Displays the level of the signal sent from the channel selected as the input channel to the MIX and MATRIX bus. The send parameters can be adjusted using the screen encoder by pressing this. Pressing again switches to the Send screen.

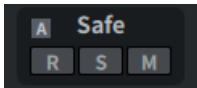

24 Safe

The Recall Safe, Solo Safe and Mute Safe statuses are displayed. Press to display the pop-up window used to switch on/off.



25 DCA/Mute

Displays the DCA and mute group to which the selected channel is assigned. The DCA/Mute Assign screen is displayed by pressing this.

NOTE

When MUTE GROUP CONTROL is on and the channel is muted and DCA MAIN is off, each indicator blinks.

About the OVERVIEW Screen



This screen simultaneously displays the main parameters of the parts of the 12 channels for which layers are selected.

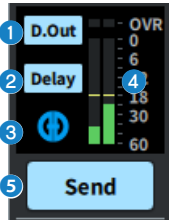

- 1 Press this to display the 12ch D.Out screen.
- 2 Press this to display the Delay screen.
- 3 Press this to open the AUTOMIXER screen.
- 4 **LEVEL meter**
The signal level set in the channel Metering Point is displayed.

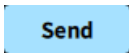

5 Send

Press this to displays the level of the signal sent from the selected channel the MIX and MATRIX bus.



6 A.Gain/D.Gain

Displays the HA analog gain. If the Gain Compensation function is turned on, a blue indicator appears, showing the analog gain position at the time the function was turned on. When the screen is pressed to select, the value can be changed by sliding vertically or horizontally or using the [TOUCH AND TURN] knob; the Gain screen is displayed by pressing it again.

If there is no analog gain, the digital gain is displayed.



7 HA indicator

Displays the on/off status of the HA's phantom power (+48V) and the input phase. When pressed, a pop-up screen is displayed that allows you to turn the phantom power on/off and switch between forward (gray) or reverse (orange) phase.

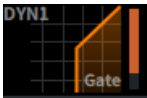

8 Press this to open the "DYNAMICS Screen" (p.73) .



9 Press this to open the "EQ Screen" (p.68) .



10 Press this to open the "DYNAMICS Screen" (p.73) .

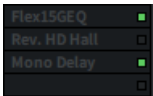

11 Opens the "Insert screen" (p.264) .

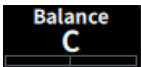

12 Pan/Balance

Displays the signal location. When the screen is pressed to select, the value can be changed by sliding vertically or horizontally or using the [TOUCH AND TURN] knob; the To Stereo screen is displayed by pressing it again.

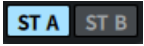

13 ST A/B

Displays the on/off for signals sent to the STEREO A bus and B bus. Press to display the pop-up window used to switch on/off.



14 DCA/Mute

Displays the DCA and mute group to which the selected channel is assigned. The DCA/Mute Assign screen is displayed by pressing this.

NOTE

When MUTE GROUP CONTROL is on and the channel is muted and DCA MAIN is off, each indicator blinks.

Screens

EQ Screen

All the EQ parameters of the currently-selected channel can be changed. This is convenient if you want to make detailed EQ settings for a specific channel.



The screen contains the following items.

- 1 **Expand/collapse button**
Expands or collapses the screen.
- 2 **Bank button**
Allows you to switch between A and B as the store destination for the EQ parameters.
- 3 **Type button**
Switches the EQ type to PRECISE, AGGRESSIVE, SMOOTH, or LEGACY.
The type of each channel can be set through Global Setting.
- 4 **EQ FLAT button**
When this is pressed, a confirmation screen appears, and when OK is pressed, the GAIN parameters for all EQ bands are reset to 0dB.
- 5 **Process Order button**
Switches the EQ and DYN2 order.
- 6 **Multi Ch View button**
Opens the Multi Ch View screen.

7 RTA button

If this button is on, a semi-opaque frequency response graph of the EQ processed input signal will be superimposed on top of the EQ frequency response graph.

8 PEAK HOLD

The peak in the graph displaying the RTA is held.

9 HOLD button

When this button is on, the frequency response graph will display and hold the result of the frequency analysis.

10 BALLISTICS field

- **BALLISTICS button**

When this is on, attenuation rate can be added to the graph plotting.

- **FAST/SLOW toggle button**

Switches the attenuation rate (FAST/SLOW).

11 Offset

Sets the offset for the RTA display.

12 EQ graph

Displays the parameter values for the EQ and filters.

13 EQ ON/OFF button

Switches the EQ on/off.

14 EQ IN/OUT level meter

Displays the peak level of signals before and after the EQ. For a stereo channel, these meters indicate the level of both the L and R channels.

15 LIBRARY button

Press this to display the CH LIBRARY screen.

16 COPY button

Copies the EQ parameter settings stored in the bank (selected via the A/B switching buttons) to buffer memory.

17 PASTE button

Press this to paste the settings copied in buffer memory to the EQ of the currently-selected bank. If valid data has not been copied into buffer memory, pasting is not possible.

18 COMPARE button

Press this to switch between and compare the settings stored in buffer memory and the currently-selected settings. If valid data is not stored in the buffer memory, comparison is not possible.

19 DEFAULT button

When this is pressed, a confirmation screen appears, and when OK is pressed, and the EQ/filters for all parameters are reset to their initial setting values.

20 HPF type select button

Allows setting of the HPF attenuation per octave to -6 dB/oct, -12 dB/oct, -18 dB/oct, or -24 dB/oct.

21 HPF FREQUENCY

Displays the HPF cutoff frequency. When the screen is pressed to select, the value can be changed by sliding vertically or horizontally or using the [TOUCH AND TURN] knob.

22 HPF ON/OFF button

Switches HPF on/off.

23 LPF type select button

Allows setting of the LPF attenuation per octave to -6 dB/oct or -12 dB/oct.

24 LPF FREQUENCY

Displays the LPF cutoff frequency. When the screen is pressed to select, the value can be changed by sliding vertically or horizontally or using the [TOUCH AND TURN] knob.

25 LPF ON/OFF button

Switches LPF on/off.

26 EQ ATT

Adjusts attenuator. When the screen is pressed to select, the value can be changed by sliding vertically or horizontally or using the [TOUCH AND TURN] knob.

27 LOW SHELVING ON/OFF button

Turn this button on to switch the LOW band to a shelving type filter.

28 BYPASS button

Sets the EQ band to bypass status.

29 HIGH SHELVING ON/OFF button

Turn on this button to switch the HIGH band to a shelving type filter.

30 EQ parameter setting

Displays the Q, FREQUENCY, and GAIN parameters for the LOW, LOW MID, HIGH MID, and HIGH bands. When the screen is pressed to select, the value can be changed by sliding vertically or horizontally or using the [TOUCH AND TURN] knob.

Touch Operation

This section explains the EQ operations performed by touching the EQ screen.

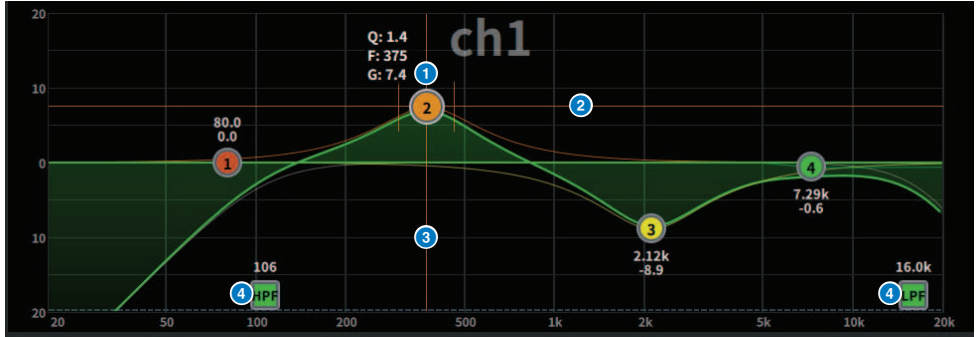

1 finger touch operations

1 Peak of selection band

Drag the band's ball to adjust frequency and gain.

The gain is reset by double tapping the ball.

If the balls for multiple bands are overlapping, the selection can be changed by tapping.

2 G axis

Drag up or down to fix the frequency and adjust the gain.

3 F axis

Drag left or right to fix the gain and adjust the frequency.

4 HPF/LPF

Drag to adjust the frequency. Double tap to turn on/off.

Multi-touch operations

• PINCH

Pinch to adjust the Q for the selected band.

Multi-band operations

The parameters for multiple bands can be adjusted all at once.

- **Boost band** Bands set in the boost area (the area above 0 dB). The boost amount for a band can be changed using multi-touch operation.

- **Cut band** Bands set in the cut area (the area below 0 dB). The cut amount for a band can be changed using multi-touch operation.

• BOOST

With three fingers, tap and hold the area above 0 dB and slide up or down to increase or decrease the amount of boost for all boosted bands.

- **CUT**

With three fingers, tap and hold the area below 0 dB and slide up or down to increase or decrease the amount of cut for all bands being cut at once.

- **EXPAND**

With four fingers, tap and hold and slide up or down to expand or reduce the gain adjustment amount for all bands at once. The same operation can be performed by placing three fingers across the 0 dB line and pinching.

DYNAMICS Screen

This allows for all dynamics parameters to be displayed and edited. This is convenient when you want to make detailed dynamics settings for a specific channel.

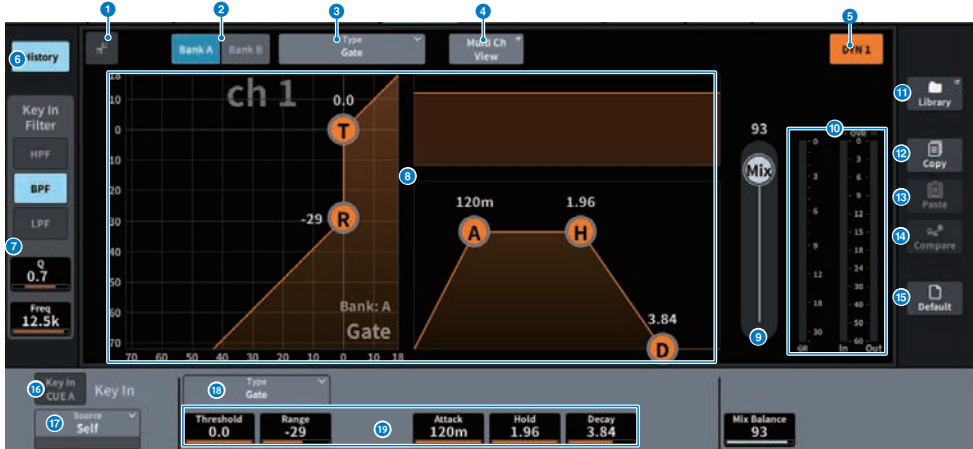

1 Expand/collapse button

Expands or collapses the screen.

2 Bank button

This allows you to switch between A and B as the store destination for the dynamics parameters.

3 Type button

Switches dynamics type between LEGACY COMP, COMP260, GATE, DE-ESSER, EXPANDER, DUCKING, FET Limiter (input channel DYN2 and output channel DYN1 only), and Diode Bridge Comp (input channel DYN2 and output channel DYN1 only).

4 Multi Ch View button

Opens the Multi Ch View screen.

5 Dynamics ON/OFF button

Switches dynamics on/off.

6 History button

When this is pressed, the last 10 seconds of history of the dynamics graph is displayed.

7 Key In Filter field (This area is not displayed if the dynamics type is De-Esser, FET Limiter, or Diode Bridge Comp.)

This function sets the filter settings for the key-in signal pass.

- **Filter selection button**

Select the type of filter from HPF, BPF, or LPF. Press a button that is on to disable the filter.

- **Q**

Displays the filter Q setting. When the screen is pressed to select, the value can be changed by sliding vertically or horizontally or using the [TOUCH AND TURN] knob.

- **FREQUENCY**

Display the cutoff frequency setting of the filter. When the screen is pressed to select, the value can be changed by sliding vertically or horizontally or using the [TOUCH AND TURN] knob.

8 Dynamics graph

Displays the input/output characteristics of the dynamics processors.

9 Mix Balance

The balance with the input signal can be adjusted.

10 Dynamics IN/OUT level meters, GR meter

These meters display the peak level of the signals before and after the dynamics processing, and the amount of gain reduction. For a stereo channel, these meters display the level of both the L and R channels.

11 LIBRARY button

Press this to display the CH LIBRARY screen.

12 COPY button

Copies the dynamics parameter settings stored in the bank (selected via the A/B switching buttons) to buffer memory.

13 PASTE button

Press this button to paste the settings that were copied in buffer memory to the dynamics of the currently-selected bank. If valid data has not been copied into buffer memory, pasting is not possible.

14 COMPARE button

Press this to switch between and compare the settings stored in buffer memory and the currently-selected settings. If valid data is not stored in the buffer memory, comparison is not possible.

15 DEFAULT button

Press this button to reset all dynamics parameters to the initial values.

16 KEY IN CUE button

This button cue-monitors the signal that is selected as the KEY IN SOURCE. The CUE will be canceled when you move to a different screen.

NOTE

Even if the Cue mode is set to MIX CUE (the mode in which all channels whose [CUE] key is on are mixed and monitored), turning on the KEY IN CUE button will cause only the signal of the corresponding channel to be monitored. All [CUE] keys that had been turned on at that time will be forcibly canceled.

17 KEY IN SOURCE selection button

Allows you to select one of the following as the key-in signal that will trigger dynamics processing.

- **Self**Signal from the same channel.
- **Other Pre DYN1**Pre-DYN1 signals on other channels (selected from a group of 24 channels each) (only Input Ch DYN1)
- **Other Pre Proc**Pre-Proc signals on other channels (selected from a group of 24 channels each) (only Input Ch DYN2)
- **MX Out**MIX channel output signal
- **EXT IN 1-4**Signal selected as EXT IN 1-4

18 Type button

Select the type of dynamics from the following.

- **Legacy Comp** This is a standard compressor that has been equipped with many of Yamaha's legacy digital mixers, such as PM1D and PM5D.
- **Comp 260**This is an analog-flavored compressor built using Yamaha's proprietary VCM (Virtual Circuitry Modeling) technology. The compression curve setting (Knee) can be selected from 6 levels: Hard / Soft-1 / Soft-2 / Soft-3 / Soft-4 / Soft-5. Although the attack/release times can also be adjusted, the preset settings reproduce the fixed characteristics of the original unit being modeled.
- **Gate**This dynamics type reduces the output by a fixed value (Range) when a signal smaller than the Threshold level is input.
- **De-Esser**This dynamics type detects only the sibilants and other high-frequency consonants of the vocal, and compresses its bandwidth.
- **Expander** This dynamics type reduces the output by a fixed ratio when a signal smaller than the Threshold level is input.
- **Ducking** This dynamics type reduces the output by a fixed value (Range) when a signal greater than the Threshold level is input. This is effective if you want to lower the volume level of background music using the Key In Source signal.
- **FET Limiter** This is a model of a FET compressor/limiter commonly used in studios. Because THRESHOLD is fixed internally, the degree of compression is adjusted by adjusting the INPUT level. (Input channel DYN2 and output channel DYN1 only)
- **Diode Bridge Comp** This is compressor modeling using Diode Bridge.(Input channel DYN2 and output channel DYN1 only)

19 Dynamics parameter settings

Displays the dynamics parameter values. These can be adjusted using the screen encoder. The type of parameters will vary depending on the currently-selected dynamics processor type.

AUTOMIXER Screen

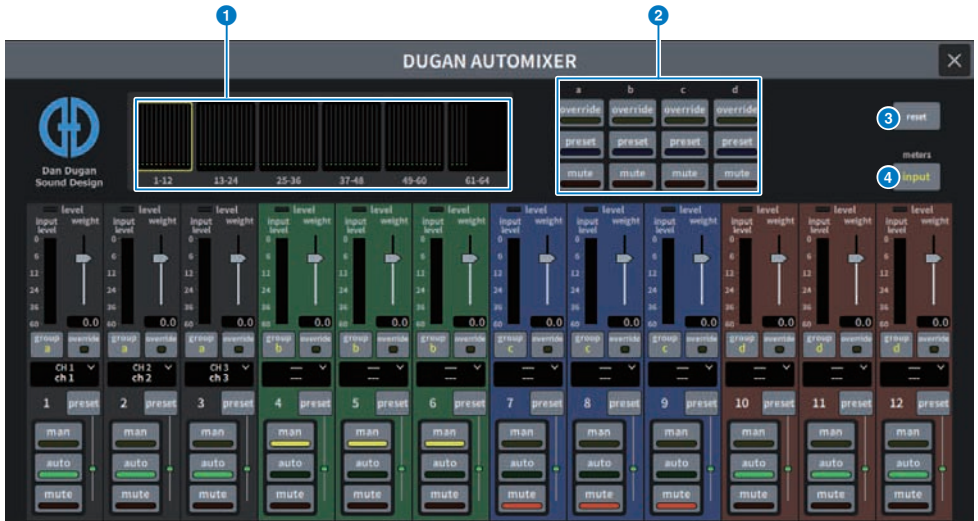

The screen contains the following items.

■ Master field

1 Channel display select buttons

Displays the automix gain meters and mode indicators (manual (yellow), auto (green), or mute (red)) for each channel. Press one of these buttons to select channels to be displayed in the channel control field below.

2 OVERRIDE/PRESET/MUTE buttons

These buttons are used to set up each group (a/b/c/d/e) selected in the channel control field. Only the buttons for the selected groups will be displayed.

• OVERRIDE

Press this button to smoothly fade-in the levels of the channels (for which the override buttons are turned on) to 0 dB (unity gain). All channels for which the override buttons are turned off will be muted.

• PRESET

Press this button to place the corresponding group of channels into a mode (manual, auto, or mute) as indicated next to the lit preset indicator.

• MUTE

Press this button to fade out all channels immediately (in 0.5 seconds).

3 reset button

Initializes the Automixer settings.

4 meters button

Switches the meter indicators displayed in the channel control field. Pressing the button repeatedly will switch among gain (automix gain), input (input level), and output (output level).

NOTICE

- Normally, the meter should be set to display gain

■ Channel control field

Each channel is always in either man, auto, or mute mode. The indicators for the active channel mode will light up. To select a mode, press the corresponding mode button or the PRESET button in the master field.

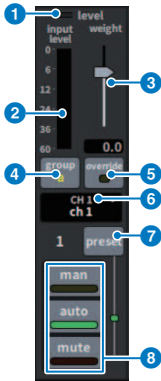

1 Level indicator

Lights up green when the audio signal reaches the level appropriate for automatic mixing.

NOTICE

- If the level indicator is flashing, raise the input gain. If the level indicator is illuminated red, lower the input gain.

2 Meter indicator

The meter indicator features three display modes. The mode will change each time the meters button in the master field is pressed.

gain (Green): Displays the Automixer gain

input (Yellow): Displays the input level

output (Blue): Displays the output level

NOTICE

- Normally, the meter should be set to display gain

3 **weight**

The weight adjusts the correlated sensitivity between input channels. Balance the weight controls so that the automix gain meters display approximately equal levels when no one is talking. For example, if there is ongoing noise near one microphone (e.g., computer fan or air vent), suppress it by reducing that channel's weight. To change the channel's weight setting, use the [TOUCH AND TURN] knob to adjust the weight slider.

Automixer calculates the ratios of the input levels of a specific channel against all input channels within the group. The following example explains how the weight control works.

■ **Raising the weight control for one channel:**

- Increases that channel's automix gain, and slightly decreases the automix gain on other channels.
- Channels with higher weight settings are more likely to gain automix gain (making it easier to be heard) than other channels.

■ **Lowering the weight control for one channel:**

- Decreases that channel's automix gain, and increases the automix gain for other channels.
- Makes it more difficult for that channel's mic to be differentiated from others when people are speaking on multiple microphones at the same time.

4 **group**

Each channel can be assigned to one of five groups (a/b/c/d/e). This group function is helpful in the following applications:

- When using multiple rooms: Assign the microphones in each room to different groups so that they can function as separate automixers.
- Stereo panning: Assign the microphones panned left, right, and center to separate groups to maintain a stable stereo presence.

5 **override**

Turning on the OVERRIDE button in the master field will place the corresponding channels into man mode or mute mode, depending on the override button status of the channel.

- When the channel's override buttons are on, turning on the OVERRIDE button in the master field will place the corresponding channels into manual (man) mode.
- When the channel's override buttons are off, turning on the OVERRIDE button in the master field will place the corresponding channels into mute mode.
- Turn off the Master OVERRIDE button to restore the previous mode for that channel.

The Override function is useful when the panel discussion leader wants to control the system.

Follow the steps below.

1. Turn on the OVERRIDE button on the channel for the leader.
2. Turn off the OVERRIDE button on all other channels.
3. Turn on the OVERRIDE button in the master field as necessary.

6 **Channel number**

The channel number and channel name to be inserted are displayed.

Press to set the channel to be inserted.

7 preset button

Press this button to select a channel mode (man, auto, or mute) that will be engaged if the PRESET button in the master field is turned on. The indicator will light up indicating when preset has been programmed for that channel.

8 man/auto/mute buttons

Switches between man/auto/mute.

man: There is no automixing, and the audio signal passes through at unity gain. Use this mode for singing through a microphone.

auto: Automixing is turned on. Use this mode for dialog or speeches.

mute: The channel's output is muted.

SCENE Screen

Scene List screen

This screen is used to manage scenes with saved mixer settings.

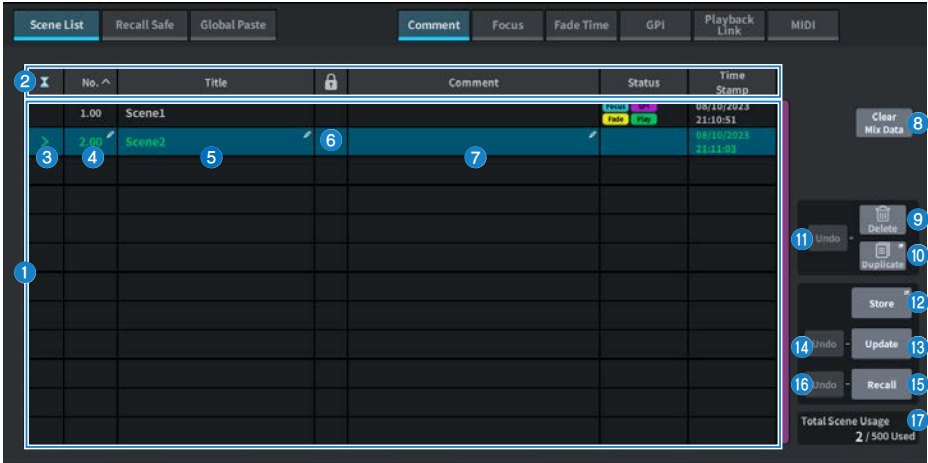

1 Scene list

This area displays information about the scenes stored in memory.

2 Sort buttons

The list will be sorted as follows, according to the column header you pressed.

- **No.**
Sorts the list in order of scene number.
- **Title**
Sorts the list in numerical/alphabetical order by title.
- **Comment**
Sorts the list in numerical/alphabetical order of comments.
- **Time Stamp**
Sorts the list by date and time of creation.

NOTE

By pressing the same location again, you can change the direction (ascending or descending order) in which the list is sorted.

3 Current scene select button

Press this button to select the scene that was recalled or stored most recently. The current scene is highlighted in green in the list.

4 Scene number

Displays the current scene number.

5 Scene title button

Displays the title assigned to the scene. Press to display the keyboard to edit the title. The maximum number of characters in a scene title is 16.

6 Protect (lock) symbol

Displays the write protect enabled/disabled status. Press to write-protect the scene, and the button lights up. Press it again to cancel write protection.

7 Selected scene

The scene highlighted in blue in the list is the currently selected scene.

8 Clear Mix Data button

Press this button to initialize the current scene.

9 Delete button

Press this button to erase the selected scene.

10 Duplicate button

Press this button to duplicate the selected scene.

11 Delete Duplicate Undo button

Undoes the delete and duplicated operations. This function is valid only immediately after you perform these actions.

12 Store button

Creates a new stores for the current mix data. Press to display the SCENE Store screen used to name and save the scene.

13 Update button

Updates scene data by overwriting the scene (that has been recalled or stored most recently) with the current mix data.

14 Update Undo button

Undoes the store operation. This is valid only if the immediately previous action was an overwrite save.

15 Recall button

Press this button to recall the currently-selected scene.

16 Recall Undo button

Undoes the recall operation. This is valid only if the immediately previous action was a recall operation.

17 Total Scene Usage Display

Displays the state of scene resource usage. The maximum number of scene data is 500.

Scene List screen (Comment)

This screen is used to manage scenes with saved mixer settings.

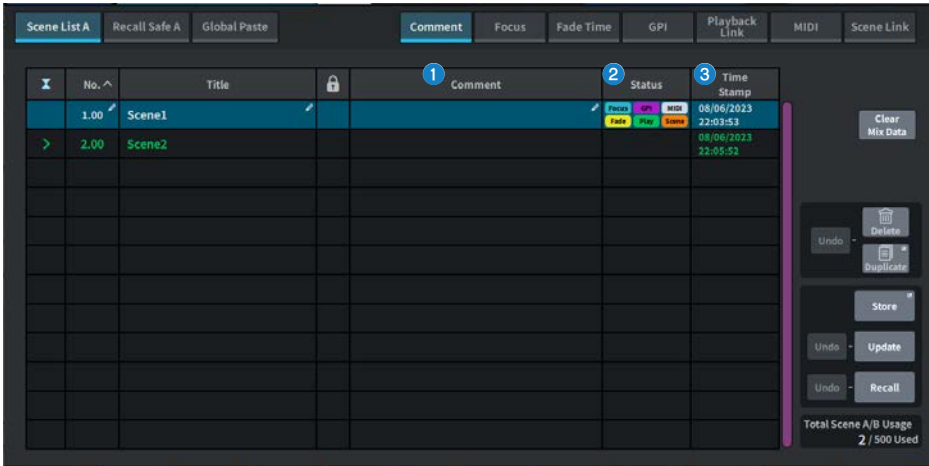

1 Comment field

Press this to display the keyboard to input scene comments.

The maximum number of characters in a comment is 32.

2 Status field

Indicators in this field display the settings for Focus, Fade, Play (Playback link: a function which plays a desired song a certain period of time after a scene is recalled), GPI (general-purpose interface), MIDI, and Scene Link.

3 Time Stamp field

Displays the date and time a scene was saved. For details about the Time Stamp display format, refer to "Setting the date and time of the internal clock".

Scene List screen (Focus)

When recalling a scene, this screen allows you to select which part of the data is to be recalled.

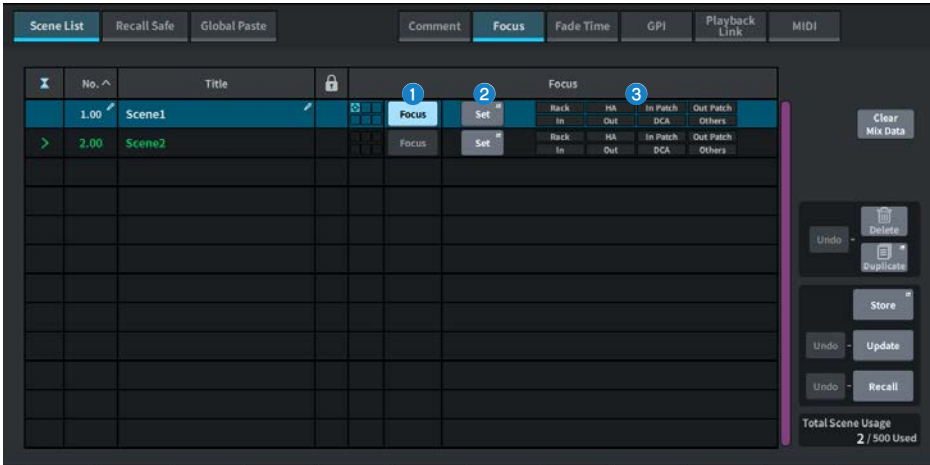

1 Focus button

Enables or disables the Focus function for each scene

2 Set button

Press this button to access the FOCUS screen, which allows you to select the parameters to be recalled.

3 Focus parameter display section

These indicators display the Focus settings that are specified for each scene (green: all parameters; blue: selected parameters).

FOCUS screen

When recalling a scene, this screen allows you to select which part of the data is to be recalled.

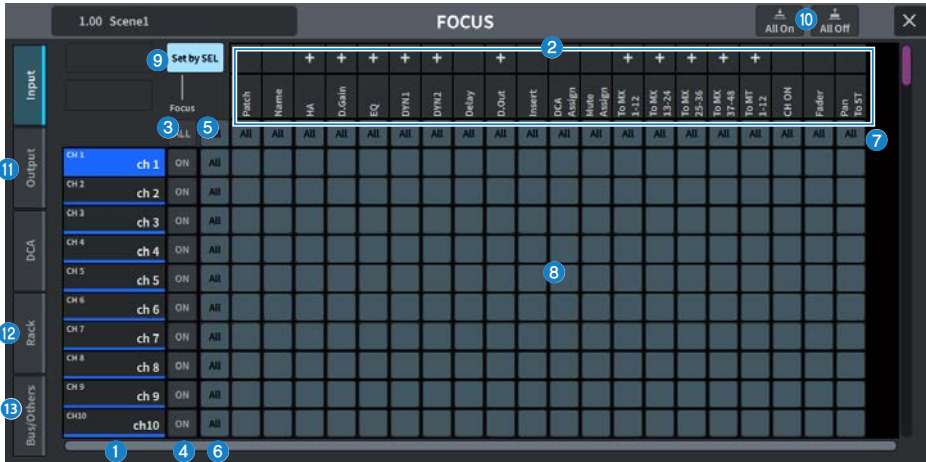

1 Channel display

Displays the channel name.

2 Category select list

Selects the category of parameters to be displayed on screen. You can press the + or – button located beneath the list to expand or collapse the channel parameter display for each category.

3 ALL channel Focus ON button

Specifies whether you want to apply the Focus function to all channels.

4 Channel Focus ON button

Turn Focus on/off for each channel.

5 All on button

Turns Focus on for all parameters on all channels.

6 All parameter settings ON button

Turns on/off the Focus setting for all parameters that are associated with the corresponding channels.

7 All channel settings ON button

Turns the Focus setting on/off for all channels associated to the selected parameter.

8 Parameter setting ON button

Turns the Focus setting on/off for parameters on each channel.

9 Set by SEL button

When this is on, the [SEL] key can be used to turn on/off the channel focus setting.

10 All On button/All Off button

Turns all the settings on/off.

11 Input, Output/DCA Tab

Press this to display the screen for setting the Focus for each channel.

12 Rack Tab

Press this to display the screen for setting the Focus for each Rack (Premium, FX, EQ, Automixer).

13 Bus/Others Tab

Press this to display the screen for setting the Focus for the Mix bus type, channel link and fader layer positions.

Scene List screen (Fade Time)

This screen allows you to set the function that causes the desired channel fader to change continuously for a certain amount of time until it reaches the new value when a scene is recalled.

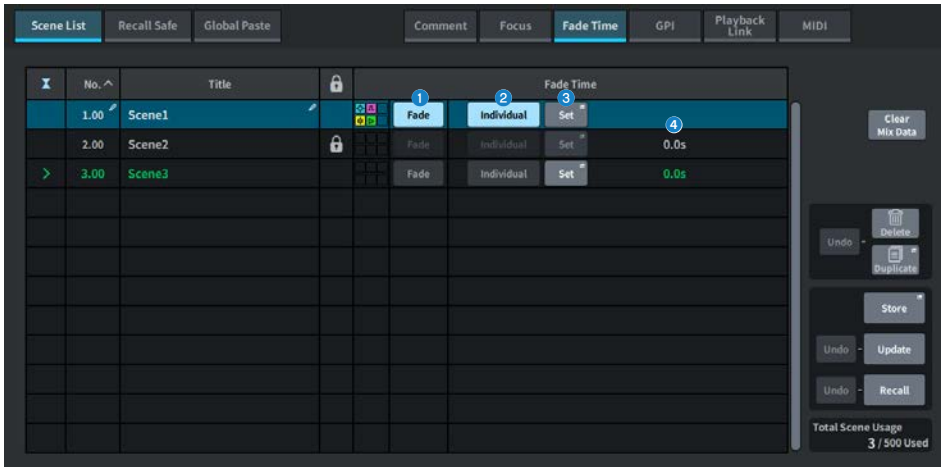

1 Fade button

Enables/disables the fade function for each scene.

2 Individual button

Switches the fade function between Global mode and Individual mode. Turn this on to set the fade time and offset time for each channel. When on, input channels can also have their Pan set individually.

3 Set button

Press to display the Fade Time screen where you can select the channel using the fade function and set the fade time (the time it takes for the fader to reach the new value).

4 Fade Time display

Displays the fade time set for each scene.

FADE TIME screen

This screen allows you to select the channel to which the fade effect will be applied and to adjust the fade time.



1 Channel display field

Displays as a highlight the channel/DCA to which the Fade effect will be applied, as selected in Channel select field 2.

2 Channel select field

Allows you to select the channels/DCAs to which Fade is applied.

3 Set by SEL button

When this button is on, you can add a channel by using the corresponding [SEL] key.

4 Fade Time setting display

This sets and displays the Fade time. Use the corresponding screen encoder to adjust the value.

5 All On button/All Off button

Turns all the settings on/off.

Individual Fade Time screen

This screen allows you to set the fade time and offset time for each channel.

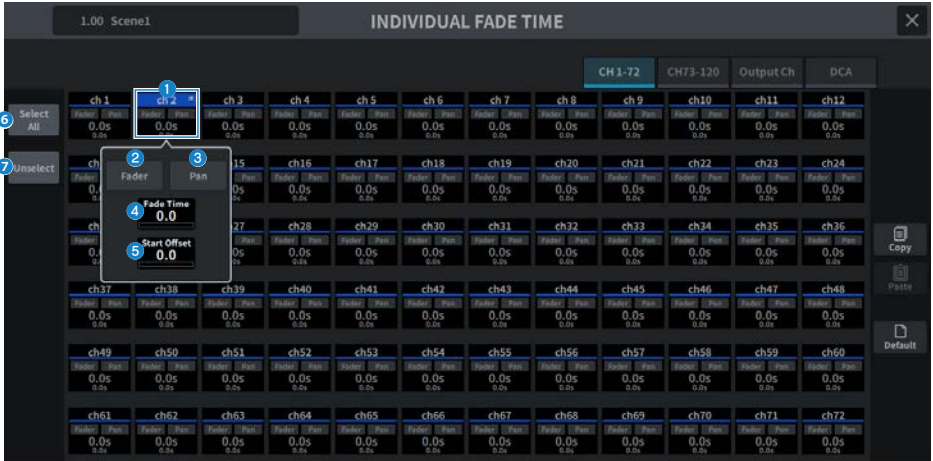

1 Channel display field

Allows you to select the channels/DCAs to which Fade is applied. When pressed, a popup screen is displayed.

2 Fader button

Sets and displays the on/off status of the Fader fade function.

3 Pan button (Input Channel only)

Sets and displays the on/off status of the Pan fade function.

4 Fade Time setting display

This sets and displays the Fade time. Use the [TOUCH AND TURN] knob or screen encoder to adjust the value.

5 Start Offset setting display

This sets and displays the Start Offset. Use the [TOUCH AND TURN] knob or screen encoder to adjust the value.

6 Select All button

Sets all channel selections.

7 Unselect button

Clears all channel selections.

PLAYBACK LINK screen

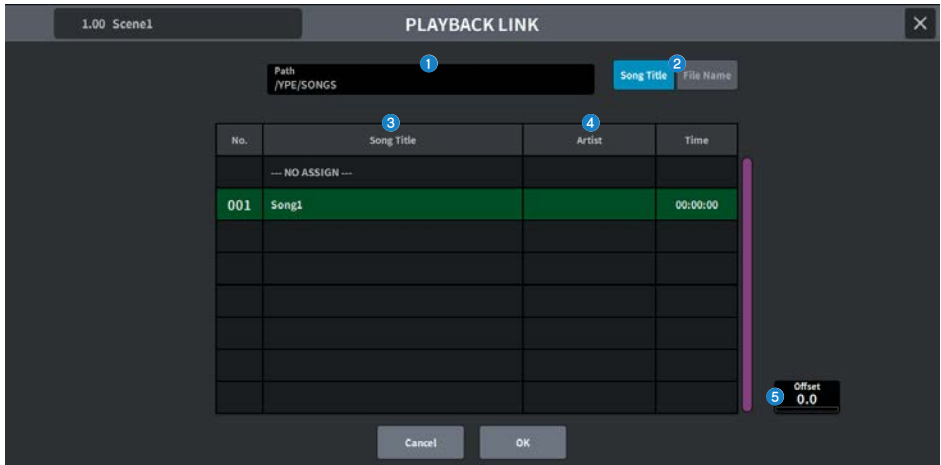

This screen contains the following items.

1 PATH indicator

This area indicates the current directory path.

2 Song Title/File Name switch buttons

Switch between the song title list and the file name list.

3 Song Title/File Name list

Displays the song title and file name of the audio files in the \YPE\SONGS\ folder.

4 ARTIST list

Displays the artist name of the audio files in the \YPE\SONG\ folder.

5 OFFSET

You can use the [TOUCH AND TURN] knob or the screen encoder to set the time interval from scene recall until the start of audio file playback.

8 Parameter setting ON button

Turns the Recall Safe settings on/off for parameters on each channel.

9 Set by SEL button

When this is on, the [SEL] key can be used to turn the Recall Safe settings on/off for the channel.

10 Input, Output, DCA tab

Press this to display the screen for setting the recall safe for each channel.

11 Rack Tab

Press this to display the screen for setting the recall safe for each Rack (Premium, FX, EQ, Automixer).

12 Bus/Others Tab

Press this to display the screen for setting the recall safe for the Mix bus type, channel link and fader layer positions.

Global Paste screen

Sets the function to copy-and-paste the settings of a desired channel or parameter to the scene data in memory.



Status field

1 Status

This displays the parameter to be copied from and the scene it will be pasted into.

2 Paste button

Press this button to paste the selected item(s) to the scene in memory.

Parameter field

3 Set by Edit button

When this is set to on, you can select channels and parameters by operating the panel or touch screen.

4 Clear button

This can cancel the selected parameter. This is displayed when the Set by Edit button is set to on.

5 Manual button

Press the Manual button to display the Global Paste Parameter screen. On this screen, select the channel and parameter to be copied from.

6 Bank button

Press this to recall the parameter settings stored in the Bank button. Press the selected Bank button again to display the keyboard screen.

Destination Scene field

7 **SUM button**

When this is on, SUM mode is enabled. In SUM mode, multiple Scene Group settings can be deployed.

8 **Scene Group button**

Press this to deploy the saved settings to the Destination Scene in the SCENE LIST. Press the selected Scene Group button again to display the keyboard screen.

9 **Scene list**

Select the scene being pasted into the (Destination Scene). The selected scene will be displayed with a highlight.

Press the Scene Group List in the Group column to display only the groups to which each scene is associated.

10 **Save button**

When this is on, Save mode is enabled. In Save mode, the contents of the scene list can be save to the selected Scene Group.

11 **All button**

Selects all the scenes in a scene list.

12 **Clear button**

Clears the highlighted selection in the scene list.

13 **Selected scene display**

This displays the number of selected scenes.

Scene List screen (MIDI)(Theater Package Compatible)

Multiple MIDI events can be issued when a scene is recalled.

There are four types of MIDI messages that can be used:

- **Note On**

C2 (0) - G8 (127) (Velocity fixed at 127)

- **Note Off**

C2 (0) - G8 (127) (Velocity fixed at 0)

- **Program Change**

No. 1 - 128

- **Control Change**

No. 0 - 119, Value 0 - 127

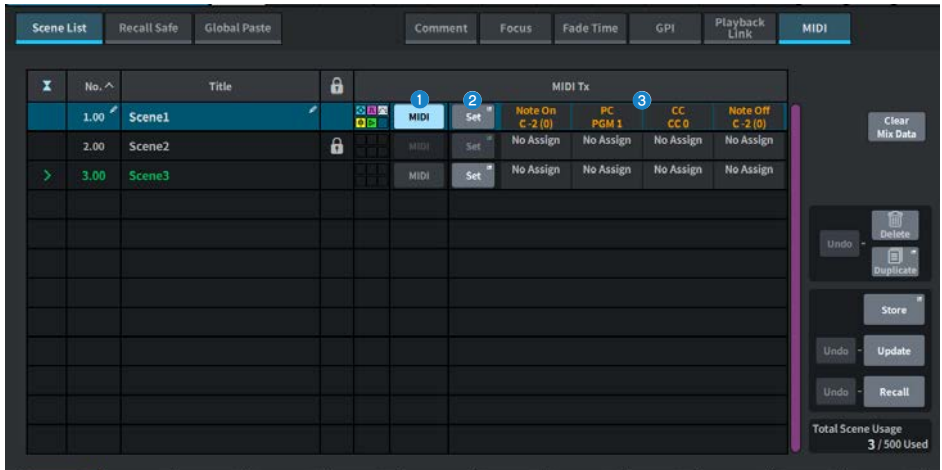

1 MIDI button

When on, the set MIDI message will be issued when the scene is recalled.

2 Set button

Opens the MIDI screen where you can set MIDI messages linked to scene recall.

3 MIDI message indicator

Displays MIDI messages linked to scene recall. MIDI messages are sent in order from left to right.

MIDI TX screen



This screen contains the following items.

1 Device selection button

Press this button to display the screen for selecting USB or PY. When PY is selected, either an "Online" (green), "Virtual" (yellow), or "No MIDI" (gray) indicator is displayed according to the status of the PY card.

2 MIDI CH selection button

Press this button to display the screen for selecting CH1-CH16 or CH ALL. If set to CH ALL, MIDI messages will be sent on all channels.

3 MIDI message command button

Press this button to display the screen for selecting MIDI commands.

4 MIDI message parameter knob

Set parameters with the [TOUCH AND TURN] knob and screen encoder. For Control Change, CTL is controlled by the screen encoder and Value is controlled by the [TOUCH AND TURN] knob.

GENERAL Screen

Displays the version and license.

Set the brightness of the touch screen, top panel LEDs, USER DEFINED KEYS display, and LED lighting bar.



This screen contains the following items.

1 Version

Displays the system software version.

2 License button

Press this button to display the LICENSE screen that displays the system software license.

3 Delay Compensation button

Press this button to open the Delay Compensation screen that automatically adjusts the delay (timing) caused by inserts and routing-based DSP processing.

4 **+48V Active button**

Switches phantom power (+48V) on/off. When this button is off, phantom power will not be supplied even if you turn on the +48V button of the [INPUT] jack input channel.

NOTE

- **Precautions related to phantom power**

- Observe the following precautions to prevent damage to the main unit/external devices and noise.
- Turn off phantom power if it is not needed.
- Turn it off when connecting a device that does not support phantom power to the [INPUT] jack on the back.
- Do not connect or disconnect a cable to the [INPUT] jack on the back while phantom power is on.
- Turn on/off with the output control set to minimum.

5 **Name Language button**

Select the language to use for the channel name.

NOTE

Use DM7 Editor or DM7 StageMix for input in languages other than English. If the language setting selected with this button and the language used for the channel name are different, some characters may not be displayed properly.

6 **Console Lock button**

This button locks the console. If you press this button when a password has been set, a PASSWORD popup window will appear. If you enter the correct password, the console will be locked. If you press this button when there is no password, the console will lock immediately.

7 **Fan button**

This is a switch that toggles the rotation speed of the cooling fan inside the equipment between HIGH and LOW.

8 **Contrast**

- **Mini LCD**

Sets the contrast of the characters in the USER DEFINED KEYS display on the top panel.

9 **Brightness**

- **Mini LCD**

Sets the brightness of the USER DEFINED KEYS display on the top panel. The brightness of the color bar on the USER DEFINED KEYS display also changes at the same time. After setting the brightness of the USER DEFINED KEYS display, use the Color Bar if you want to adjust the brightness of the color bar on the USER DEFINED KEYS display.

- **Color Bar**

Sets the brightness of the color bar of the USER DEFINED KEYS display on the top panel. You can set the relative brightness of the color bar on the USER DEFINED KEYS display without changing the brightness of the USER DEFINED KEYS display.

- **Panel**

Sets the brightness of the LEDs on the top panel.

- **Screen**

Sets the brightness of the touch screen.

- **Light**

Sets the brightness of the LED lighting bar at the top of the top panel.

10 **Color**

Sets the color of the LED lighting bar at the top of the top panel.

11 **Bank button**

Select the bank (A/B) for setting the panel settings.

12 **Actor button (Theater Package compatible)**

Press this button to display the ACTOR screen.

DELAY COMPENSATION Screen

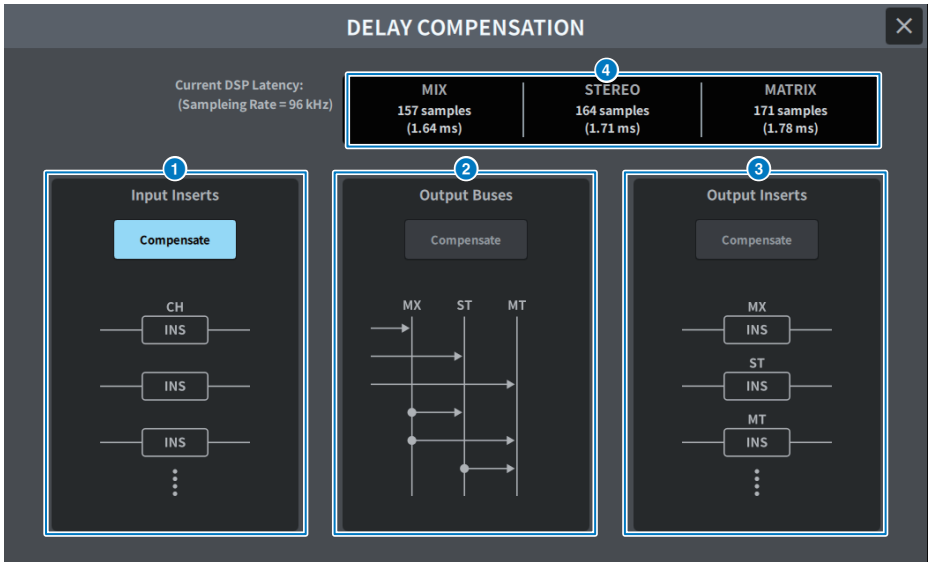

The screen contains the following items.

NOTE

By default, only INPUT INSERTS is on.

1 INPUT INSERTS COMPENSATE button

When this is on, the delay caused by the input channel inserts is automatically adjusted. When using this compensation, all input channel signals will be delayed by 44 samples.

2 OUTPUT BUSES COMPENSATE button

When this is on, delays for each bus in the MIX/ST/MATRIX are automatically adjusted. When using this compensation, output from the MIX bus is delayed by 18 samples and the output from the STEREO bus is delayed by 9 samples. When used simultaneously with OUTPUT INSERTS COMPENSATE, the output from the MIX bus is delayed by 132+18 samples, the output from the STEREO bus is delayed by 132+9 samples, and the output from the MATRIX bus is delayed by 132 samples.

3 OUTPUT INSERTS COMPENSATE button

When this is on, the delay caused by the output channel inserts is automatically adjusted. When using this compensation, output signals from the MIX bus is delayed by 44 samples, the output from the STEREO bus is delayed by 88 samples, and the output from the MATRIX bus is delayed by 132 samples.

sample	fs 48kHz	fs 96kHz
9	0.19msec	0.09msec

sample	fs 48kHz	fs 96kHz
18	0.38msec	0.19msec
44	0.92msec	0.46msec
88	1.83msec	0.92msec
132	2.75msec	1.38msec
132+9	2.94msec	1.47msec
132+18	3.13msec	1.56msec

4 Latency display

This displays the latency (msec) from the time a signal enters the DSP (engine) through the INPUT until it is output to each bus. Latency is added when Delay Compensation is applied. This will vary according to the Fs (sampling rate).

- **MIX** Latency from INPUT to MIX OUT
- **STEREO** Latency from INPUT to STEREO OUT
- **MATRIX** Latency from INPUT to MATRIX OUT

USER SETUP Screen

USER SETUP screen

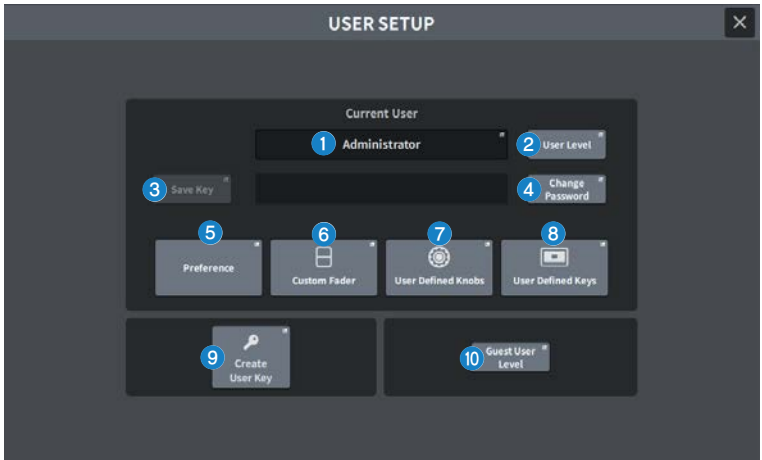

The screen contains the following items.

1 Current User button

Press this to display the screen used to switch the logged in user.



2 User Level button

Press this to display the CREATE USER KEY screen used to set the logged-in user.

3 Save Key button

Press this display the screen to overwrite and save the user authentication key.



The power user (Administrator) can use an empty slot for a new save.

4 Change Password button

Press to display the screen to change the password.

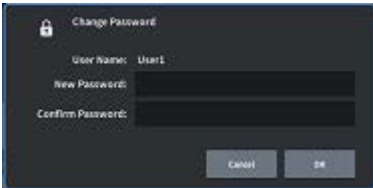

5 Preference button

Press this button to display the “PREFERENCE screen” (p.110) where various preferences can be set.

6 User Defined Keys button

Press this to display the “USER DEFINED KEYS Screen” (p.118) , where you can make USER DEFINED key-related settings.

7 User Defined Knobs button

Press this to display the “USER DEFINED KNOBS screen” (p.115) , where you can set the parameters related to the USER DEFINED knobs, and assign functions to the Channel Strip encoders.

8 Custom Fader button

Press to display the “CUSTOM FADER screen” (p.113) , where you can make settings for custom faders, which can freely combine channels.

9 Create User Key button

Press this to display the “CREATE USER KEY screen” (p.121) used to create new users.

10 Guest User Level button (Power user (Administrator) only)

Press this to display the “GUEST USER LEVEL screen” (p.124) , where you can set the guest user login.

PREFERENCE screen

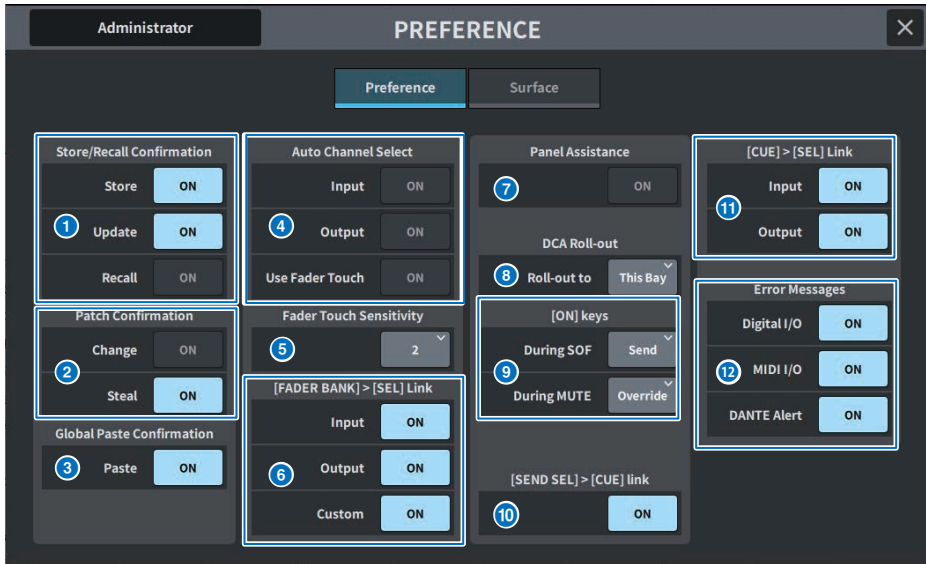

1 Store/Recall Confirmation

Allows you to turn on/off options related to scene store/update/recall operations. When this is on, a confirmation message is displayed when you perform a Store, Update, or Recall operation.

2 Patch Confirmation

Allows you to turn on/off options related to patch operations.

- **Change**

When this is on, a confirmation message is displayed when you edit an input patch or output patch.

- **Steal**

When this is on, a confirmation message is displayed when you edit an input or output patch that is already patched to a port.

3 Global Paste

When this is on, a confirmation message is displayed when you perform a global paste.

4 Auto Channel Select

Sets whether a channel will be selected when the [ON] key or fader for the channel is operated.

- **Input**

- **Output**

This can be turned on/off separately for input channels and output channels.

- **Use Fader Touch**

Touching a fader will automatically select the corresponding channel via the Touch Sense function built into the fader.

5 Fader Touch Sensitivity

The Touch sensitivity can be adjusted in five steps. Higher values provide greater touch sensitivity.

6 [FADER BANK] > [SEL] Link

Specifies whether channel selection will be linked with fader bank selection. You can set this parameter separately for INPUT (input channels), OUTPUT (output channels), and CUSTOM (Custom fader bank). If this button is on, when you select the corresponding fader bank, the channels in that bank that was selected most recently will be selected, and its [SEL] key will illuminate.

7 Panel Assistance

If the Panel parameter in the Brightness field is set to less than 50%, when this is set to on, all the LED indicators on the panel will be dimmed.

8 DCA Roll-out

Roll-out to

Sets the Bay for DCA Roll-out.

9 [ON] keys

During SOF

Selects the operation of the [ON] keys during SENDS ON FADER mode.

- **Send**Turns Send on/off
- **Channel**Turns Channel on/off

This is useful when the monitor engineer wants to control the channel on/off at all times, even during SENDS ON FADER.

During MUTE

Selects the operation of the [ON] keys while muted.

- **Override**Turns mute on/off
- **Channel Off**Turns the Channel on/off

10 [SEND SEL]>[CUE] Link

When in SENDS ON FADER mode, this turns on/off the CUE state follow operation when the destination bus is switched.

11 [CUE]>[SEL] Link

Sets whether channel selection will be linked with cue operations.

12 Error Messages

• **Digital I/O**

If this is on, and a digital audio I/O error (Console AES/EBU input/output, PY slot digital input/output) occurs, an error message will be displayed.

• **MIDI I/O**

If this on, if a MIDI transmission/reception error occurs, an error message will be displayed.

• **DANTE Alert**

When this is on, if a Dante error occurs, an error message will be displayed.

Surface screen (DM7 only)

Set top link layer selections for multiple Surface bays.

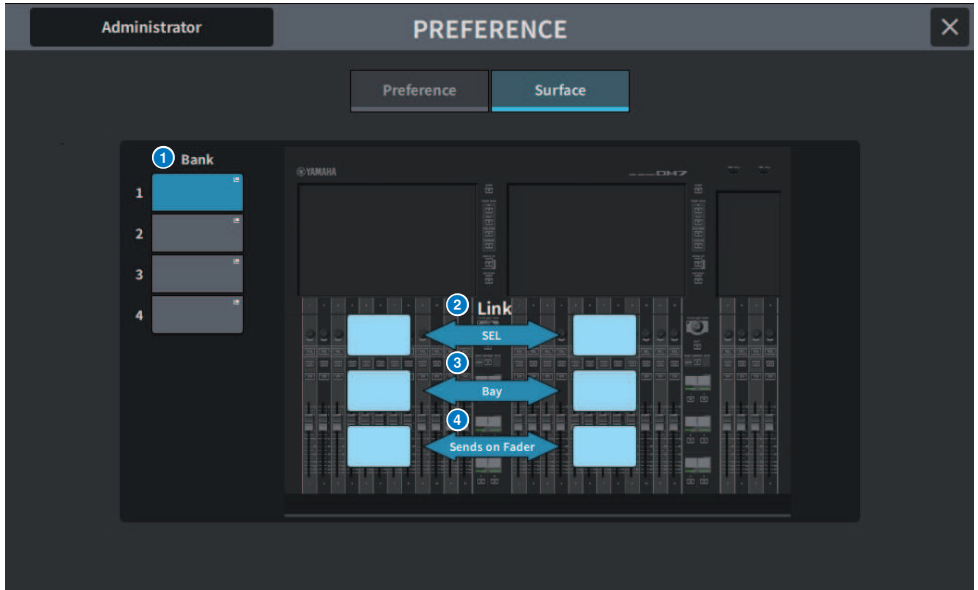

1 Bank

Press this to recall the saved setting.

2 SEL

This links the channel selection.

3 Bay

This links Bay setting and fader layer selection.

4 SENDS ON FADER

This links the SENDS ON FADER on/off and destination bus.

CUSTOM FADER screen

CUSTOM FADER screen

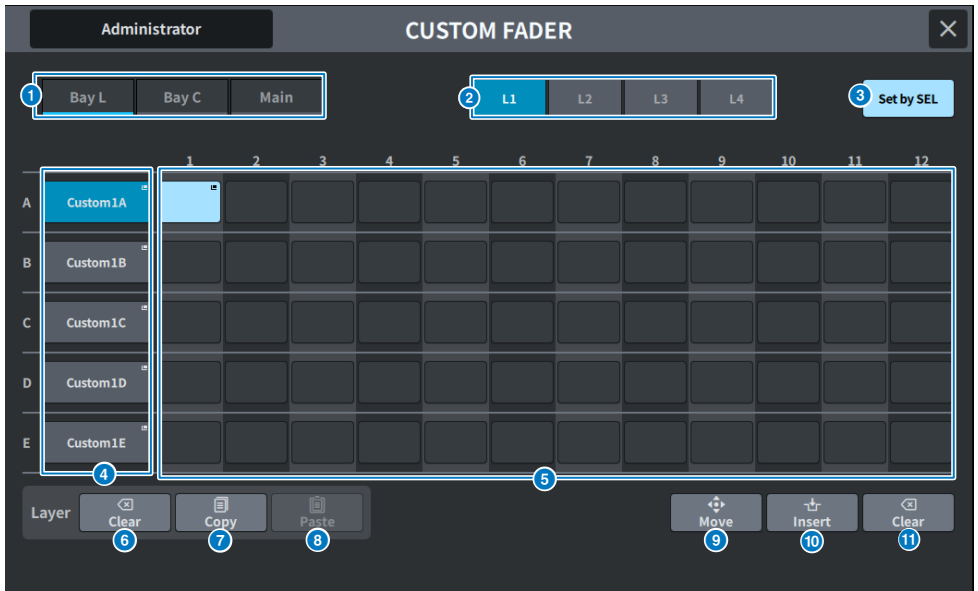

The screen contains the following items.

1 Bay select buttons

This allows you to select a bay or main fader to which you want to assign a combination of channels.

2 Bank select buttons

This allows you to select a bank to set up.

3 Set BY SEL button

When this is on, channels can be assigned to the currently selected fader assign button using the [SEL] key.

4 NAME popup button

Press this to display the keyboard used to name layers.

5 Fader assign button

Selects the position to assign a custom fader. Press the selected fader assign button again to display the CH SELECT screen which will selecting the channel to assign. The assigned channels will be displayed.

6 LAYER CLEAR button

This button sets the settings for the currently selected layer to unassigned. Press this to open the confirmation screen, and press OK to execute. Otherwise, press CANCEL to return to the previous screen without changing anything.

7 LAYER COPY button

Copies the selected layer.

8 LAYER PASTE button.

Pastes to the selected layer.

9 MOVE button

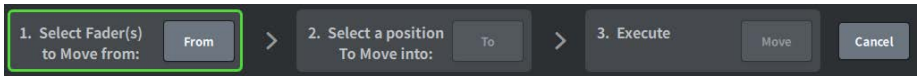

Press to enter MOVE mode to move the fader. After using the fader assign button to select the move source, press the TO button. Next, select the fader assign button for the move target, and press the MOVE button.

10 INSERT button

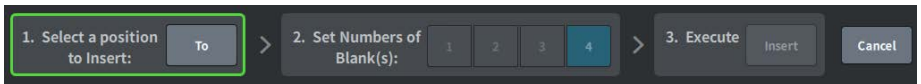

Press to enter INSERT mode to add a fader. After selecting the position to be added using the Fader assign button, select the number of additions (1-4). Next, press the INSERT button.

11 CLEAR button

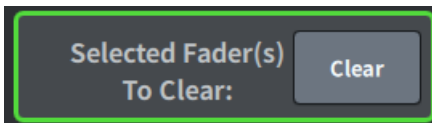

Press to clear the assigned fader (no assignment).

Press to enter CLEAR mode to delete the fader block. After using the fader assign button to select the fader to be deleted, press the CLEAR button.

USER DEFINED KNOBS screen

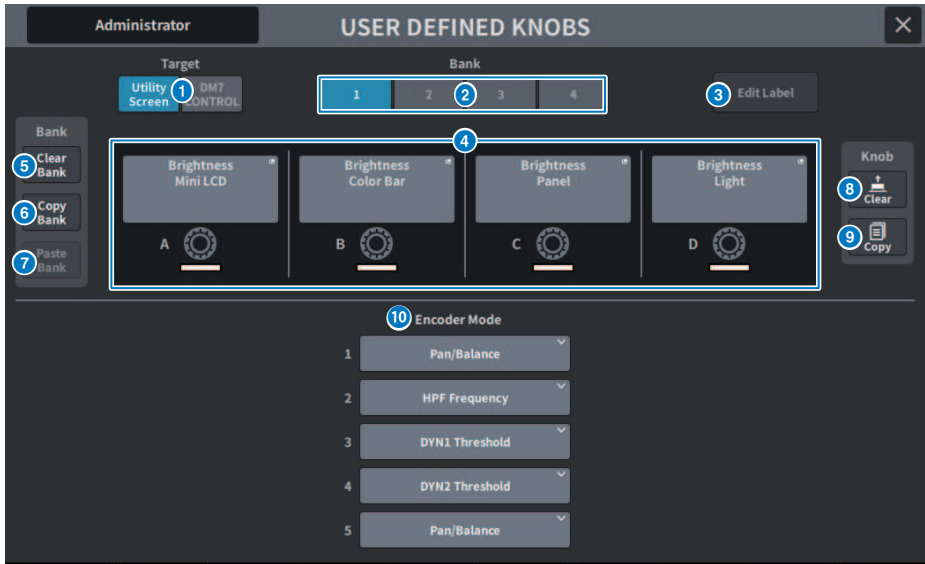

This screen contains the following items.

1 Target button

Select the USER DEFINED knob to be set from the Utility screen or DM7 Control.

2 Bank 1-4 tabs

Allows you to switch between the banks ([1]/[2]/[3]/[4]) for the USER DEFINED knobs.

3 Edit Label button

Press this button to enter edit mode, which allows you to set the title and color.

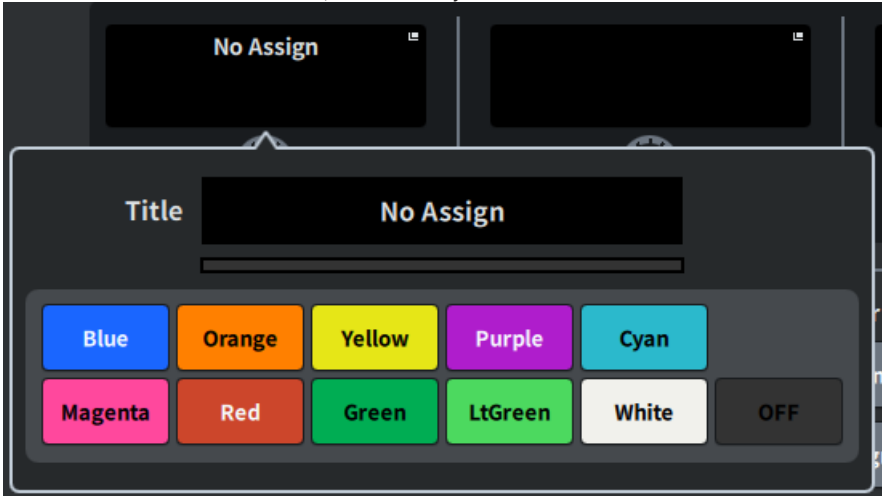

Press it again to return to normal mode.

4 USER DEFINED KNOBS A-D

These buttons correspond to the USER DEFINED knobs [A] to [D] on the panel. Press to display the USER DEFINED KNOB screen for assigning functions. If nothing is assigned to the button, "No Assign" is displayed.

5 Clear Bank button

Press this button to display a confirmation message. Press OK to clear all current Banks.

6 Copy Bank button

Press this button to copy the current Bank.

7 Paste Bank button

Press this button to display a confirmation message. Press OK to paste the copied Bank settings.

8 Clear button

Press this button to enter clear mode. Select the knob you want to clear and press the Clear button.

9 Copy button

Press to enter copy mode. Select the knob you want to copy. However, this will not copy the Short Name or Color between the Utility screen and the DM7 control.



Paste button

Press this button to enter paste mode. Press the knob you want to paste to select it. (Multiple selections are allowed)

10 Bay Encode Mode

Use the screen encoders to select the function you want to assign. You can assign the following functions.

- Pan/Balance
- Analog Gain
- Digital Gain
- Auto A.G./D.G.
- HPF Frequency
- LPF Frequency
- DYN1 Threshold
- DYN2 Threshold
- Delay
- Selected Send
- MX 1–48 Sends
- MT 1–12 Sends

USER DEFINED KEYS Screen

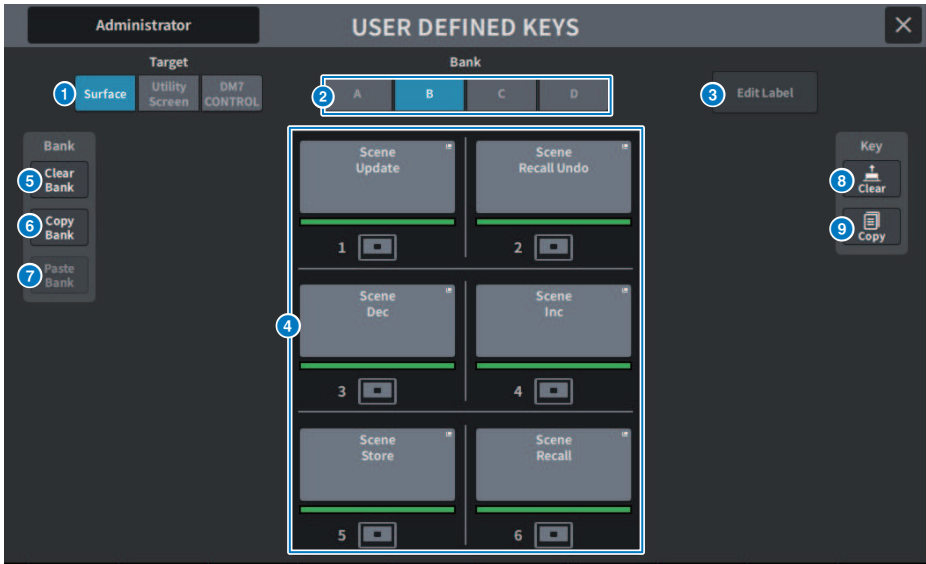

This screen contains the following items.

1 Target button

Select the USER DEFINED key to be set from the panel (Surface), Utility screen, or DM7 Control.

2 Bank tab

Switches the bank of USER DEFINED keys ([A] to [D] on the panel and DM7 Control, 1 to 4 on the Utility screen).

3 Edit Label button

Press this button to enter edit mode, which allows you to set the title and color.

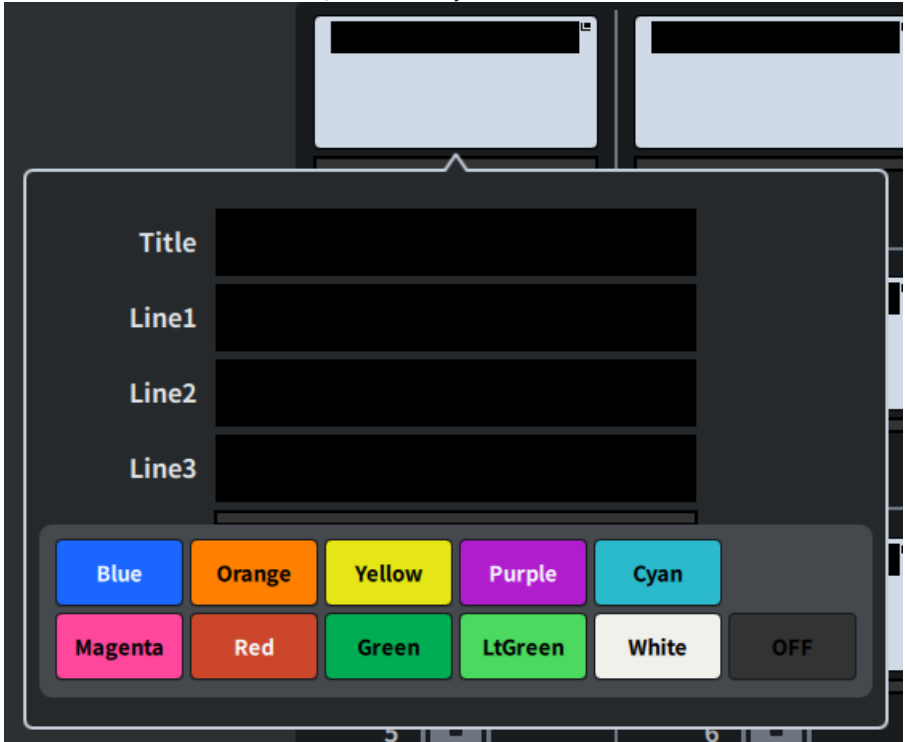

Press it again to return to normal mode.

4 USER DEFINED KEYS

These buttons correspond to USER DEFINED keys [1] to [6] on the panel (or USER DEFINED keys 1 to 12 on the Utility screen). Press to display the USER DEFINED KEY screen for assigning functions. If nothing is assigned to the button, "No Assign" is displayed.

5 Clear Bank button

Press this button to display a confirmation message. Press OK to clear all current Banks.

6 Copy Bank button

Press this button to copy the current Bank.

7 Paste Bank button

Press this button to display a confirmation message. Press OK to paste the copied Bank settings.

Since the number of banks is different between the Surface and Utility screens and DM7 Control, the method of copying and pasting is different. Patterns (Left, Middle, Right) will be displayed, so select one and execute.

8 Clear button

Press this button to enter clear mode. Select the key you want to clear and press the Clear button.

9 Copy button

Press to enter copy mode. Select the key you want to copy.



Paste button

Press the key you want to paste to select it. (Multiple selections are allowed)

CREATE USER KEY screen

This screen allows you to create user authentication keys and save them to the main unit or to a USB drive.

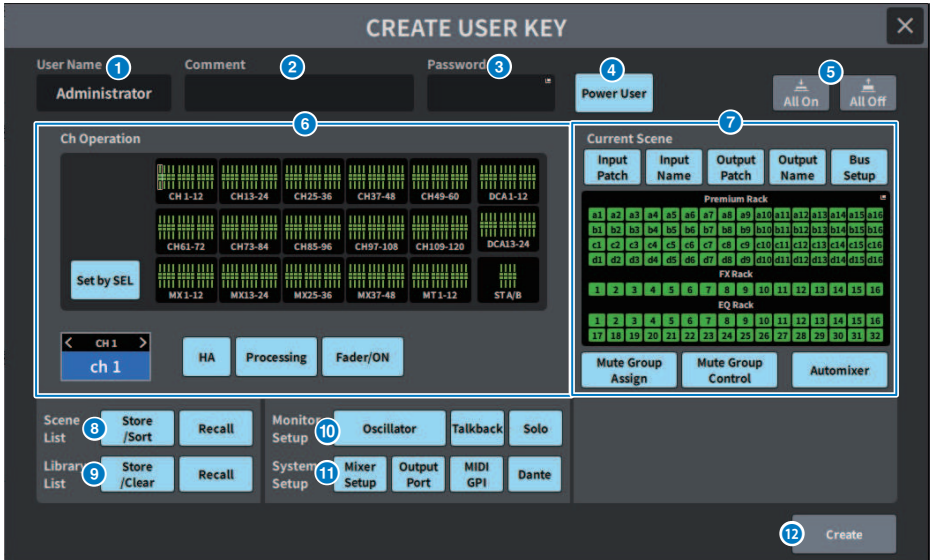

1 User Name

This displays the user name. Press here to display the keyboard screen which you can use to enter a user name of up to 16 characters.

2 Comment

This displays user-related comments. Press here to display the keyboard screen which you can use to enter a comment of up to 32 characters.

3 Password

This sets the password. Press here to display the keyboard screen which you can use to enter a password of up to 8 characters.

4 Power User

This sets whether or not power user rights are granted.

5 All On/All Off

This permits/clears all items that can be set.

6 Ch Operation

Sets the range of operation for each channel in the input channels, output channels, and DCA groups. The currently selected channel is the target of the setting. In the lower portion of CH OPERATION, the settings for the currently selected channel are displayed. The channel to be set is selected by pressing the [SEL] key on the panel or select channel. The type of buttons displayed depends on the selected channel/group.

- **INPUT channel**[HA], [Processing], [Fader/ON]
- **MIX/MATRIX channel**.....[With Send], [Processing], [Fader/ON]
- **STEREO channel**.....[Processing], [Fader/ON]
- **DCA Group**.....[DCA Main], [DCA Group Assign]

- **HA**Restricts operations on the HA (head amp) patched to that channel.
- **Processing**.....Restricts operation of general signal processing parameters (except faders, [ON] key, send level, etc.) for that channel.
- **Fader/ON**.....Restricts operation of faders, [ON] key, send level, etc. for that channel.
- **With Send**.....Restricts send parameter operations to that channel.
- **DCA Main**Restricts operation of the fader, ON/OFF, and ICON/COLOR/NAME for that DCA group.
- **DCA Group Assign**Restricts the assignment change operations for that DCA group.
- **Set by SEL**When this button is on, pressing the [SEL] key for the appropriate channel on the panel will collectively set/reset the above operation authorizations for that channel.

7 Current Scene

This sets the range of possible operations for current scene memory.

- **Input Patch/Input Name**Restricts operations on patches and names for input channels.
- **Output Patch/Output Name**.....Restricts operations on patches and names for output channels.
- **Bus Setup**.....Restricts bus setup operations.
- **Premium Rack/FX Rack/EQ Rack**.....Restricts operations on the different racks. This is set on the RACK CREATE USER LEVEL screen displayed when this area is pressed.
- **Mute Group Assign/Control**Restricts mute group assignment and mute group control operations.
- **Automixer**Restricts Automixer operations.

NOTE

For the DM7 Compact, faders that are not available for that model will not be displayed

8 Scene List

This sets the range of possible operations for scene memory

- **Store/Sort** Store/sort operations
- **Recall**Recall operations

9 Library List

This sets the range of possible operations for each type of library.

- **Store/Clear** Store/Clear operations
- **Recall**Recall operations

10 Monitor Setup

This sets the range of possible operations for monitor setup.

- **Oscillator**
- **Talkback**
- **Solo**

11 System Setup

This sets the range of possible operations for system setup.

- **Mixer Setup**
- **Output Port**
- **MIDI GPI**
- **Dante**

NOTE

- The details of the restrictions with the Dante button are shown below:
- Change of Console ID
- Change of Secondary Port settings
- Change of leadership (This Console or Dante Controller) for Dante Patch changes
- Change of Bit Depth
- Change of Latency
- Change of Device Mount
- Change of Remote HA Assign
- Change of Dante Input Patch
- Change of Dante Output Patch
- Change of Dante Input Patch Library (Recall changes only)
- Change of PREFERRED LEADER
- If operation has been restricted, a "Permission Denied" message is displayed at the bottom of the screen.
- The factory default setting is Off (no restrictions).

12 Create button

This creates user authentication keys containing the user rights that have been set.

GUEST USER LEVEL screen

This screen displays and changes the user level.

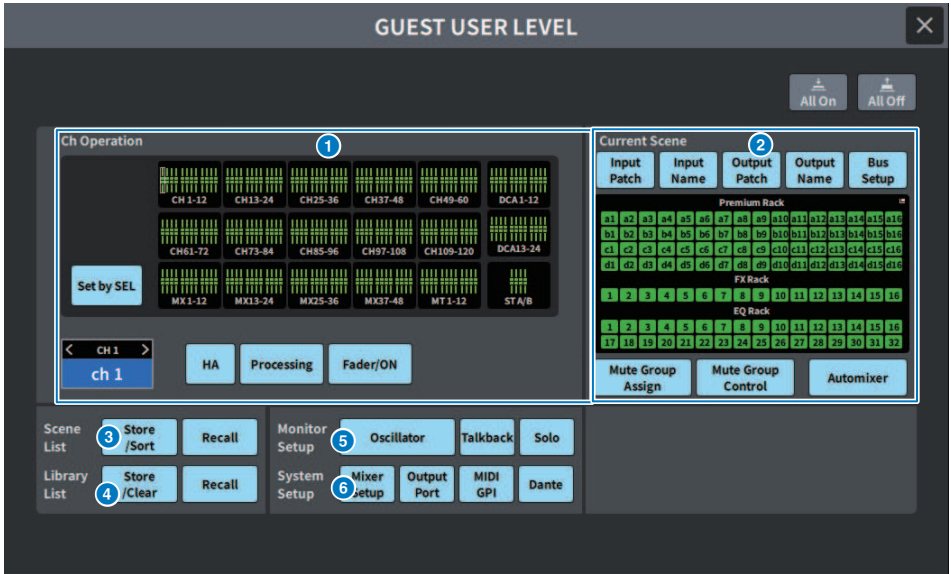

The setting items conform to “CREATE USER KEY screen” (p.121) .

BUS SETUP screen

BUS SETUP Screen

Change basic bus settings (stereo/mono switching, Pan Link, etc.).



1 Signal type switch buttons

This allows you to select how signals are processed for every adjacent pair of buses. You can select Stereo (stereo signal) or Mono × 2 (monaural signal × 2 systems).

2 Bus type selection buttons

This selects the bus type for every adjacent pair of buses. You can select Vari (variable send level), Fixed (fixed send level), or Mix Minus (Broadcast Package compatible).

3 Pan Link button

This button appears when the Signal Type is Stereo and set to Vari. When the button is on, the signal sent to the corresponding channel will be linked to the To Stereo pan.

N-1 Owner button

This appears when Mix Minus (Broadcast Package compatible) is selected. If you press this button, a screen where you can select the Owner channel for mix minus settings (input channels that use mix minus) will be displayed.

BUS SETUP (Send Point) screen

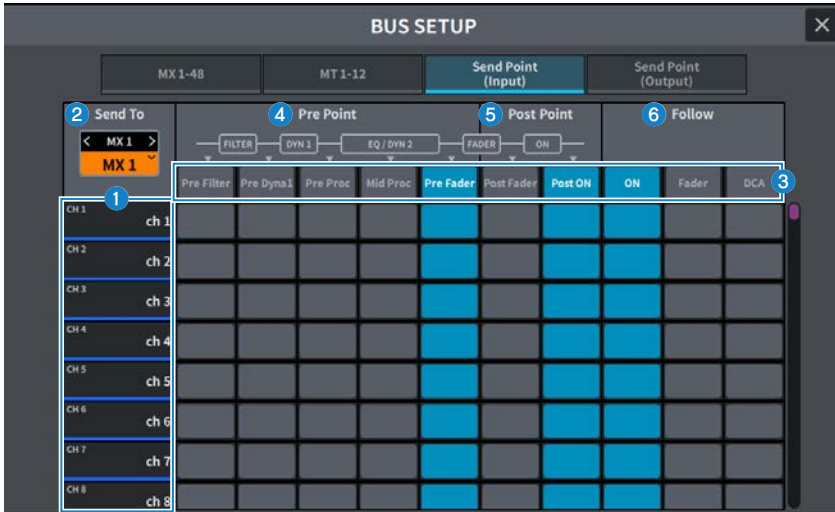

The screen contains the following items.

1 Channel list

This displays the channels.

2 SEND TO

Selects a channel on the MIX/MATRIX bus as the signal destination. Press < to switch to the previous channel and > to switch to the next channel. Press √ to display a list of channels and you can switch to any channel.

3 All button

Press this to apply the selected send point to all channels simultaneously.

4 Pre send point select buttons

This allows you to select the send point for each channel for which Pre is turned on. These buttons correspond to the following parameters.

Buttons	Send Point
Pre Filter	Immediately before the filter
Pre Dyna1	Immediately before DYNAMICS1
Pre Proc	Immediately before EQ and DYNAMICS2
Mid Proc	Between EQ and DYNAMICS2
Pre Fader	Immediately before the fader

5 Post send point select buttons

Allows you to select the send point for each channels for which Pre is turned off (Post). These buttons correspond to the following parameters.

Buttons	Send Point
Post Fader	Immediately after the fader
Post ON	Immediately after the [ON] key

6 Follow settings button

Allows you to select for each channel whether the signal sent to the MIX/MATRIX bus will follow the ON/Fader/DCA settings regardless of the send point. These buttons correspond to the following parameters.

Buttons	Setting
ON	Follow ON
Fader	Follow Fader
DCA	Follow DCA

WORD CLOCK Screen

This screen sets the DM7 Series word clock.

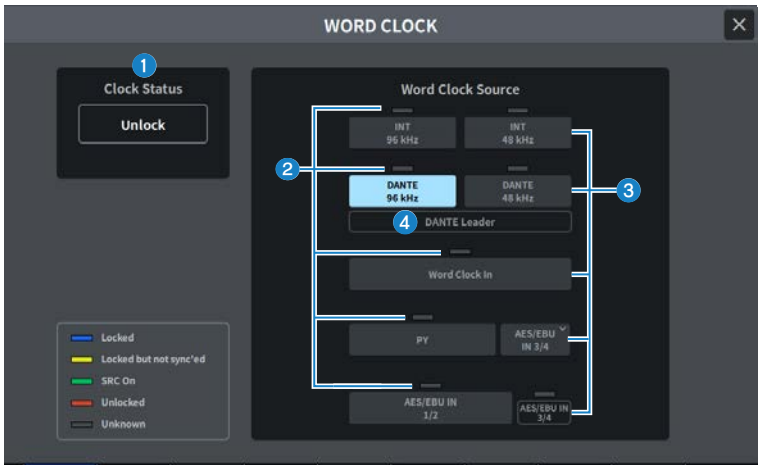

1 Clock frequency display

This display the frequency (48 kHz or 96 kHz) of the currently-selected clock. If this is not syncing, "Unlock" is displayed at this position.

2 **Clock status display**

This displays the status of synchronization to the clock (status) for each clock source. The details of each display is explained below.

- **Locked (Blue)**

Indicates that a clock synchronized with the selected clock source is being input. If an external device is connected to the corresponding connector or slot, it indicates that a clock is being input or output properly between that device and the DM7 Series. If the sampling frequency is close, this status may be displayed even if not synchronized.

- **Locked but not sync'ed (Yellow)**

A valid clock is being input, but is not synchronized with the selected clock source. If an external device is connected to the corresponding connector, it indicates that a clock is not being input or output properly between that device and the DM7 Series.

- **SRC On (Green)**

This is the status applied to PY slots and [AES/EBU] terminals. This indicates that the SRC (Sampling Rate Converter) is enabled for the corresponding channel. Therefore, even if it is asynchronous, normal input/output is performed between with the DM7 Series.

- **Unlocked (Red)**

A valid clock is not being input. If an external device is connected to the corresponding connector, a clock will not be input or output properly between that device and the DM7 Series.

- **Unknown (Grey)**

This indicates that the clock status cannot be detected because there is no valid clock input. You will be able to select this connector/slot, but successful synchronization cannot occur until a valid connection is established.

NOTE

- If the indicator for the port selected as the clock source turns blue and the clock frequency is displayed, the DM7 Series is operating normally with the new clock.
- If the indicator for the selected clock does not turn blue, make sure that the external device is connected correctly, and that the external device is set to transmit clock data.
- Noise may occur at the output terminals when the word clock setting is changed. To protect your speaker system, be sure to turn down the power amp volume before changing the word clock setting.

3 **Clock select buttons**

Select the clock source to be used as the clock from the following options:

- **INT 96 kHz**
- **INT 48 kHz**

The internal clock (sampling rate: 96 kHz or 48 kHz) will be used as the clock source.

- **DANTE 96 kHz**
- **DANTE 48 kHz**

The word clock provided from the Dante audio network (sampling rate: 96 kHz or 48 kHz) will be used as the clock source.

- **WORD CLOCK IN**

The word clock supplied from the WORD CLOCK IN jack on the rear panel is used as the clock source.

- **PY**

The word clock supplied from the PY card slot on the rear panel is used as the clock source.

- **AES/EBU IN**

The word clock supplied from AES/EBU IN on the rear panel is used as the clock source.

NOTE

If the unit is initialized to the factory default status, the word clock default value will be set to DANTE 96 kHz.

4 **DANTE Clock status display**

This is displayed when it is set to clock leader or clock follower on a Dante audio network.

MIDI/GPI Screen

MIDI/GPI (MIDI Setup) screen

This screen sets the MIDI input and output.

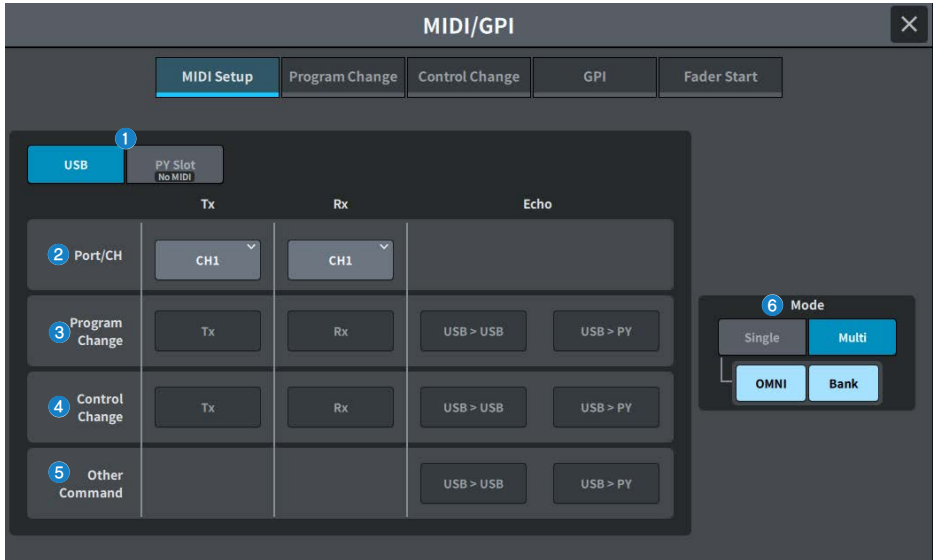

1 USB/PY Slot

This selects the component to be configured for MIDI message sending and receiving.

- **USB**

USB port

- **PY slot**

PY slot

2 PORT/CH field

This allows you to specify the settings for the channel that sends and receives MIDI messages.

- **Tx CH**

This allows you to specify the settings for the MIDI channel that sends MIDI messages.

- **Rx CH**

This allows you to specify the settings for the MIDI channel that receives MIDI messages.

3 **Program Change field**

This allows you to switch MIDI Program Change message send and receive on/off.

- **Tx**

This switches Program Change sending on/off.

- **Rx**

This switches Program Change receiving on/off.

- **Echo**

Switches the echo output of Program Change messages (resending Program Change messages without modification) on/off.

4 **Control Change field**

Allows you to switch MIDI Control Change message sending and receiving on/off.

- **Tx**

Switches Control Change message sending on/off.

- **Rx**

Switches Control Change message receiving on/off.

- **Echo**

Switches the echo output of Control Change messages (resending Control Change messages without modification) on/off.

5 **Other Command field**

Switches the echo output of other MIDI messages (resending other messages received from external devices without modification) on/off.

6 **Program Change Mode field**

Allows you to select the Program Change send/receive mode.

- **Single**

If this button is on, Program Changes will be sent and received only on a single MIDI channel (Single mode).

- **Multi**

If this button is on, Program Changes will be sent and received on multiple MIDI channels (Multi mode).

- **OMNI**

If this button is on, Program Changes on all MIDI channels are received in Single mode. Single mode sending and Multi mode sending and receiving are disabled.

- **Bank**

If this button is on, Bank Select messages can be sent and received in Single mode (Bank Select messages switch the group of Program Change messages to be used.).

MIDI/GPI (Program Change) screen

This screen is used to assign scene memory to a Program Change.

When a scene is recalled, a Program Change message for the corresponding number can be sent to an external device. Conversely, the corresponding scene can be recalled when a Program Change message is received from an external device.



1 Program Change field

Switches Program Change send and receive on/off. This setting is linked with the Program Change field on the MIDI Setup screen.

USB

- **Tx**

If this button is on, the corresponding Program Change is sent to the USB port when a scene recall is performed.

- **Rx**

If this button is on, the corresponding scene is recalled when the Program Change is received from the USB port.

- **Echo USB>USB / Echo USB>PY**

When this is on, Program Change messages that are received from an external device are sent without modification.

PY Slot

- **Tx**

When this is on the corresponding Program Change message is sent to the PY slot when a scene is recalled.

- **Rx**

When this is on, the corresponding scene is recalled when a Program Change message is received on the PY slot.

- **Echo PY>PY / Echo PY>USB**

When this is on, Program Change messages that are received from an external device are sent without modification.

2 Program Change Mode field

This allows you to select the Program Change send/receive mode. It is linked with the MIDI Setup screen.

3 List

This is a list that displays the scene recall operation assigned to each MIDI channel and MIDI Program Change number. The list shows the following items.

- **CH/Bank**

When "CH" is displayed, the column indicates the MIDI channel (1–16) on which Program Changes are sent/received. If Program Change send and receive is set to Single mode and the Bank button is on, the display will change to Bank", and the numerical value in this column will correspond to the bank number.

- **NO**

Indicates the program number 1–128.

- **Program Change Event**

Displays the scene number/scene name assigned to each channel (bank number) or program number. Press an individual assignment display area to open the MIDI Program Changescreen, to select the content that you want to assign.

4 Scroll button

This scroll up and down the list by channel or bank.

5 CLEAR ALL button

Press this button to clear all scene recall assignments in the list.

MIDI/GPI (Control Change) screen

This screen assigns parameters such as fader operation and [ON] key on/off to Control Changes. MIDI Control Change messages can be used to control assigned parameters.

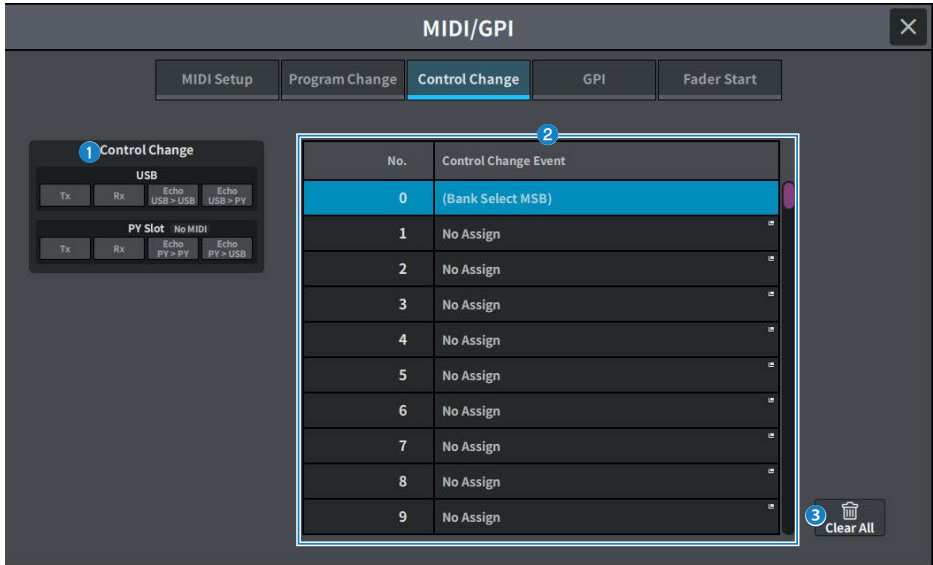

1 Control Change field

This allows you to switch Control Change send/receive on/off, and specify whether echo output of the Control Changes will be performed. It is linked with the MIDI Setup screen.

2 List

This displays the fader/knob operations or [ON] key on/off operations that are assigned to each control number.

- **No.**

This displays the control number. You can use control numbers 1–31, 33–95, and 102–119.

- **Control Change Event**

Displays/selects the type of parameter assigned. When you press a parameter, the MIDI Control Change screen is displayed, allowing you to change the control number assignment.

3 CLEAR ALL button

Press this to clear all parameter assignments in the list.

4 POLARITY MODE select button

This button selects the polarity of the GPI IN port.



..... (Low active) Becomes active when the input signal is low level.



..... (High active) Becomes active when the input signal is high level.

5 GPI OUTPUT button

Press this button to display the GPI OUTPUT screen. The button displays the name of the currently-selected function or parameter.

6 TEST button

While this button is on, the corresponding GPI OUT port will become active and outputs a control signal.

7 POLARITY MODE select button

Allows you to select the polarity of the GPI OUT port.



..... (Low active) Grounded when the GPI OUT port is active.



..... (High active) Open when the GPI OUT port is active.

8 GPI OUT status indicator

Indicates the status of the voltage that is being output from each GPI OUT port.

9 Local/PY Slot

Switches the display of the GPI setting target. Simultaneous operation is possible.

MIDI/GPI (Fader Start) screen

This sets linked operation with the fader for devices connected to the GPI OUT port.



Output Destination field

1 GPI OUT1 – GPI OUT10 buttons

Select the GPI OUT port to be set.

2 Fader display

Displays the selected fader. Press to open the GPI OUT FADER START screen and the channel can be set.

When the Set by SEL button is On, the fader is selected using the [SEL] on the main panel.

3 Set by SEL button

When this button is on, you can add a channel by using the corresponding [SEL] key.

Mode field

You can select the fader operation mode that will be the trigger for signal output from the GPI OUT port. You can choose from the following fader modes.

4 No Assign

Operating the fader for the selected channel will not output a signal.

5 Fader Start

A trigger signal of 250 msec duration will be output if the fader for the selected channel is raised from below the specified Upstroke level (between -138.0 dB and 10.0 dB) to above that level.

6 Fader Stop

A trigger signal of 250 msec duration will be output when the fader for the selected channel reaches the specified Downstroke level (between $-\infty$ dB and 9.95 dB).

7 Fader Tally

A trigger signal will be output if the fader for the selected channel is raised from below the specified Upstroke level (between -138.0 dB and 10.0 dB) to above that level. This signal will be held until the fader reaches the specified Downstroke level (between $-\infty$ and 9.95 dB), or until that GPI OUT port receives a different trigger. The following illustration shows how the output signal from the GPI OUT port will change when a fader is operated in each fader mode. In this example, the Threshold field is set to -60.00 for Upstroke, and to $-\infty$ for Downstroke. (In this illustration, Low Active is selected as the POLARITY of the GPI OUT port. If High Active POLARITY is selected, the output signal polarity will be reversed.)

NOTE

At the high level, the output signal of the port will be open. If the receiving device requires high level, take it from the +5V power supply pin. However in this case, there is a limit on the amount of current that can be provided. For details, refer to the "Control input/output specifications."

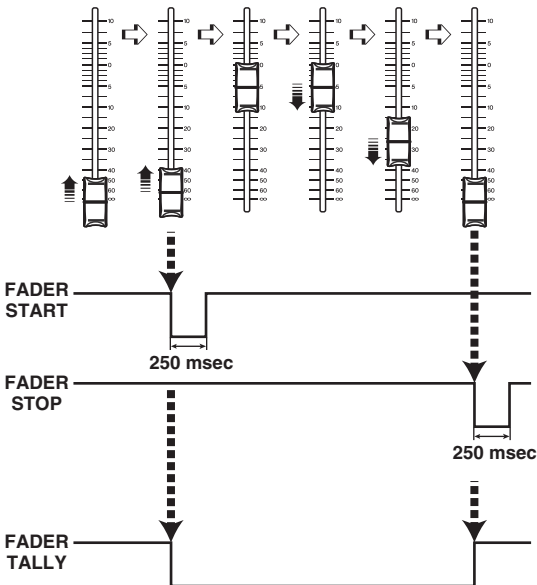

Threshold field

8 Upstroke/Downstroke

These knobs set the level that will be serve as the threshold at which to output a trigger signal. A trigger signal will be output when the fader exceeds the Upstroke level, or when the fader falls below the Downstroke level.

When the screen is pressed to select, the value can be changed by sliding vertically or horizontally or using the [TOUCH AND TURN] knob.

NOTE

- The Threshold values specified by the Upstroke/Downstroke knobs are common to all GPI OUT ports. However, a channel (fader) can be selected for each GPI OUT PORT. Only the Upstroke value will be valid if Mode is set to Fader Start, and only the Downstroke value will be valid if Mode is set to Fader Stop. If Mode is set to Fader Tally, both the Upstroke and Downstroke values will be valid.
- Regardless of the Fade Time setting, a trigger signal is output immediately after the recall by determining the position to be reached when that scene has completed the recall.

Audio Follow Video Screen (Broadcast Package Compatible)

This is a function used by broadcasting stations where the mixing console automatically controls the fader level corresponding to the video in response to the tally from the Video Switcher. It reduces the burden on the operator and avoids problems such as being unable to respond to sudden camera switching and not being able to hear the sound.



1 Selected channel

Selects the channel for Audio Follow Video (AFV). Press < to switch to the previous channel and > to switch to the next channel. Press V to display a list of channels and you can switch to any channel.

2 Enable AFV button

Turns the channel's AFV function on/off.

3 Trigger selection button

Selects the GPI IN that will trigger the channel's AFV.

4 Open Offset

This is the time period from when the GPI IN ON event is received until the fade starts.

5 Open Time

This is the time period from when the fade starts until it reaches the Open Level (the fader level corresponding to fader open).

6 Close Offset

This is the time period from when the GPI IN OFF event is received until the fade starts.

7 Close Time

This is the time period from when the fade starts until it reaches the Close Level (the fader level corresponding to fader close).

8 Open Fader Level Capture button

Sets the current channel fader level as the Open Fader Level.

9 Open Fader Level Fader

This is the fader level set by the GPI IN ON event.

10 Close Fader Level Capture button

Sets the current channel fader level as the Close Fader Level.

11 Close Fader Level Fader

This is the fader level set by the GPI IN OFF event.

12 Copy button

Copies the currently displayed parameters.

13 Paste button

Pastes the copied parameters.

14 Default button

Returns the parameters to their initial values.

15 AFV graph display

A graph that shows changes in fader level caused by AFV.

16 Overview display

Displays the channel assignment status.

NOTE

- If the operator is manually controlling the faders, manual control will take precedence.
- If a scene recall fade (Global Fade or Individual Fade) is triggered during an AFV fade, the AFV fade will be interrupted.

DATE/TIME Screen

This select the date/time setting for the unit's internal clock and the date/time display method.

The screenshot shows the DATE/TIME configuration screen. At the top, there are three dropdown menus: 'Time Zone' (set to Tokyo), 'Date' (set to MM/DD/YYYY), and 'Time' (set to 24-Hour). Below these is a calendar grid showing dates from 7/15/2019 to 11/19/2023. A 'DST (+1:00)' button is highlighted. At the bottom, there are 'Reset' and 'Set' buttons.

- 1 Time Zone**
Specifies the internal clock's time zone.
- 2 DST (Daylight saving time)**
Sets daylight saving time mode for the internal clock.
- 3 Date**
Sets the date display format and the date.
- 4 Time**
Switches between 12-hour clock format and 24-hour clock format.
- 5 Reset button**
Returns to the original time setting.
- 6 Set button**
Confirms the date and time that has been set.

NETWORK Screen

NETWORK (For Mixer Control) screen

The NETWORK (For Mixer Control) screen is used to configure the network settings required when connecting to a computer or iOS device using the NETWORK connector on the DM7 Series.

Please use the settings to match to the computer and network being connected.

NOTE

Please refer to the DM7 Editor Installation Guide for the setting method when connecting to a LAN.

1 IP address acquisition method button

This selects the method used to acquire an IP address.

- **DHCP:**

Automatically acquires the IP address using DHCP (Dynamic Host Configuration Protocol).

- **Static IP :**

Set your own IP address.

2 IP Address

This sets the addresses to identify individual devices on the Internet or within the LAN.

3 Subnet Mask

Defines how many bits of the IP address used on the network are used for the network address that identifies the network.

4 Gateway Address

This sets the addresses that identify devices (gateways) that interconvert data of different media and protocols within the network.

5 Name

Sets the name to be displayed within the network.

6 PIN

Sets the PIN (4-digit numeric password) to be entered when connecting to the DM7 Series main unit through the MonitorMix application.

MonitorMix is an application that allows performers to adjust monitor balance from the stage.

7 Bus Permission button

Press this button to display a screen for selecting the bus to connect to Monitor Mix.

NOTE

- When the IP address acquisition method button has been set to DHCP, setting **2**, **3**, **4** is not required. When it has been set to Static IP, the screen to set **2**, **3**, **4** is displayed. Enter the values for each item.
- Please set For Mixer Control and For Device Control on different Subnets.

NETWORK (For Device Control) screen

The NETWORK (For Device Control) screen is used to configure the network settings required when controlling devices on a Dante audio network.

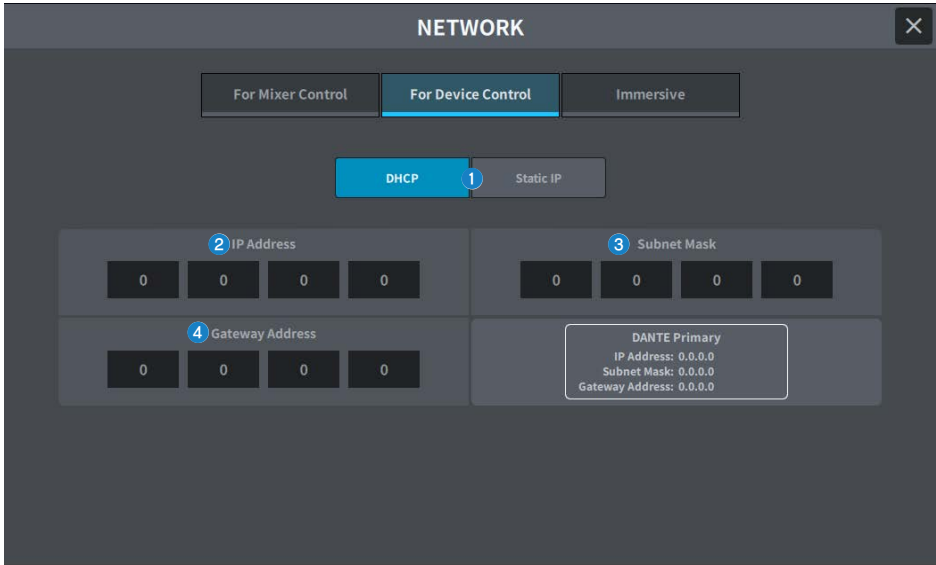

1 IP address acquisition method button

This selects the method used to acquire an IP address.

- **DHCP:**
Automatically acquires the IP address using DHCP (Dynamic Host Configuration Protocol).
- **Static IP :**
Set your own IP address.

2 IP Address

These buttons specify the ID used to distinguish individual devices on a Dante audio network.

3 Subnet Mask

Defines how many bits of the IP address used on Dante audio network are used for the network address that identifies the network.

4 Gateway Address

This sets the addresses that identify devices (gateways) that interconvert data of different media and protocols within the Dante audio network.

NOTE

- When the IP address acquisition method button has been set to DHCP, setting ②, ③, ④ is not required. When it has been set to Static IP, the screen to set ②, ③, ④ is displayed. Enter the values for each item.
- Please set For Mixer Control and For Device Control on different Subnets.
- When the IP address set in For Device Control and the subnet of the IP address of the DM7's PRIMARY port that can be confirmed on Dante Controller are different, the DM7 will not be able to discover devices on the Dante audio network.

Error Messages

 Dante Control Communication Error! When Console DANTE Primary IP is set as Static, DEVICE CONTROL IP Address must be in same Subnet.	 Network Addressing Error! DEVICE CONTROL and MIXER CONTROL IP Address must be in different Subnets.
 Network Addressing Error! MIXER CONTROL and DANTE Primary IP Address must be in different Subnets.	 Network Addressing Error! MIXER CONTROL and DEVICE CONTROL IP Address must be in different Subnets.

NETWORK screen: IMMERSIVE SOUND tab (Theater Package Compatible)

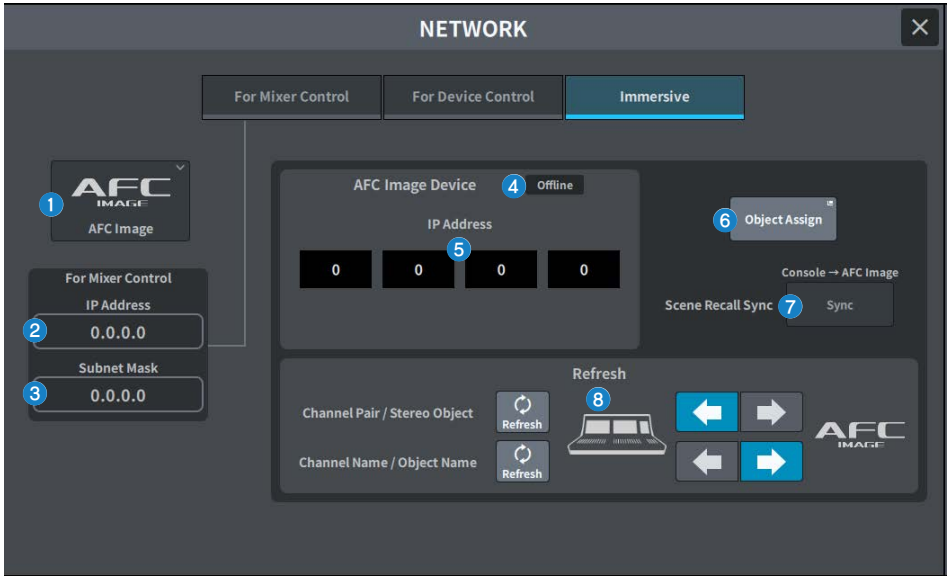

This screen contains the following items.

- 1 Immersive Device Settings button**
Press this button to select and mount an AFC Image.
- 2 IP Address Display**
Displays the set IP address.
- 3 Subnet Mask Display**
Displays the set Subnet Mask.
- 4 Connection Status Display**
 - **Online:** Connected
 - **Offline:** Not connected
- 5 Network Settings**
Set the IP address.
- 6 Object Assign**
Press to open the AFC Image object assign screen. .

7 Scene Recall Sync

Turn this on to recall the AFC scene in sync with the scene recall on the console.

8 Refresh

Matches the channel pair status, name, icon, and channel color. Use the Direction Setting button to determine the direction, and set it with the REFRESH button.

IMMERSIVE SOUND popup window (1CH)

AFC IMAGE parameters can be viewed and edited for the corresponding multiple channels.
(Example: Stereo channel)



1 Immersive Sound graph

Displays parameters for AFC IMAGE.

2 CONTROL button

Switches the control on or off. When this button is turned off, the position cannot be operated from the console.

3 Parameters

Displays the position (X, Y, Z), size and send level of objects. Use the screen encoder or the [TOUCH AND TURN] knob to operate the parameters.

4 SOLO

Switches the Solo function on or off. The SOLO CLEAR button disables all solo functions.

The SOLO and SOLO CLEAR buttons for which show mode is turned on in AFC IMAGE will be hidden.

IMMERSIVE SOUND popup window (OBJ1-36, OBJ37-72, OBJ73-108, OBJ109-128)

AFC IMAGE parameters can be viewed and edited for the corresponding multiple channels.



1 CONTROL button

Switches the control on or off. When this button is turned off, the position cannot be operated from the console.

2 Display Switch Button

Switches the objects displayed on the screen.

3 Immersive sound graph

Displays AFC IMAGE parameters.

4 Parameters

Displays the position (X, Y, Z), size and send level of AFC IMAGE. Use the screen encoder or the [TOUCH AND TURN] knob to operate the parameters.

SOLO

- 5 Switches the Solo function on or off. The SOLO CLEAR button disables all solo functions. The SOLO and SOLO CLEAR buttons for which show mode is turned on in AFC IMAGE will be hidden.

OBJECT ASSIGN screen



This screen contains the following items.

1 AFC Object Number

Indicates the AFC object number.

2 Channel Assign

Displays the Input/Mix assigned to the object. Press to display the channel assignment screen.

3 Input Patch

When an Input channel is assigned to the object, the Input patch is displayed. Press to change the Input patch.

4 Direct Out Point

Select the signal extraction point from Pre Filter, Pre DYN1, Pre Proc, Mid Proc, Pre Fader, Post Fader, and Post On. Press the Set All button to set all input channels assigned to the object at once.

5 Direct Out Patch

When an Input channel is assigned to the object, the Direct Out patch is displayed. Press to change the Direct Out patch.

6 Output Patch

When a Mix channel is assigned to the object, the Output patch is displayed. Press to change the Output patch.

7 Generate Custom Fader

Generates a custom fader setting from the current assignment order. Press the Generate button to display a screen for selecting the custom fader bank in which to save the settings.

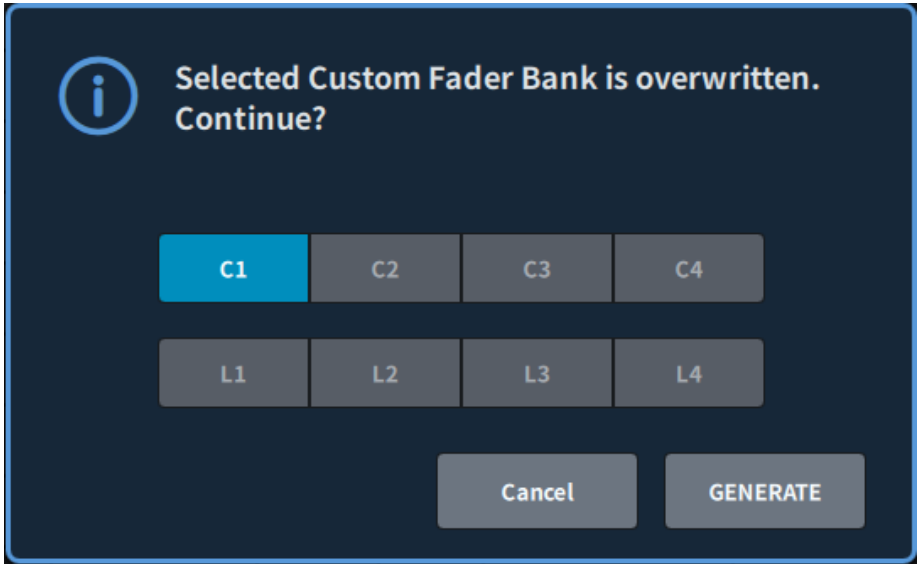

PY Slot screen

PY Slot screen

This adds the PY card to be used.

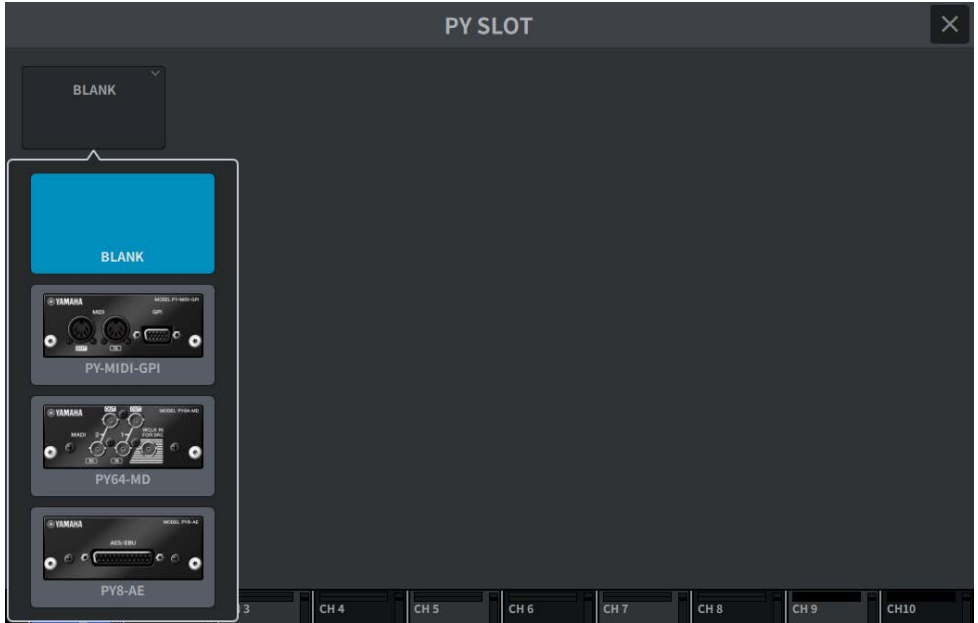

When a card is selected, the setting screen is displayed.

When the selected card is online, an "Online" indicator is displayed, and when it is offline, a "Virtual" indicator is displayed.

- **PY-MIDI-GPI**...Press the MIDI/GPI button to display the “MIDI/GPI (MIDI Setup) screen” (p.131) .
- **PY64-MD**...Displays the “PY64-MD screen” (p.156) .
- **PY 8 -AE**...Displays the PY8-AE screen (same items as the “AES/EBU INPUT screen (DM7 only)” (p.193) and “AES/EBU OUTPUT Screen” (p.194) screens).

PY64-MD screen

The illustration shows the screen when a PY64-MD card is selected. The screen contains the following items.

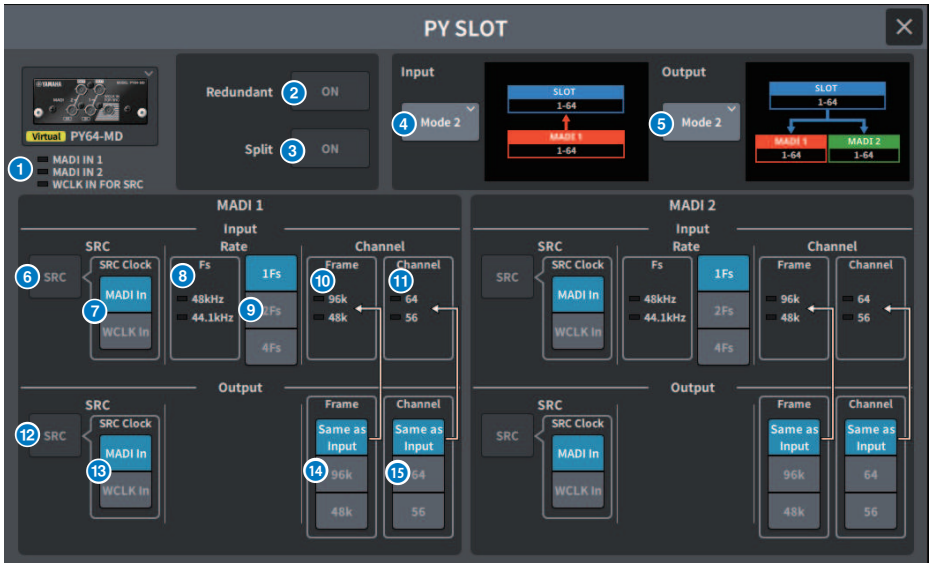

1 Input indicator

Displays the input signal status.

MADI 1 IN, MADI 2 IN: Illuminated (solid) when synchronized, flashing when asynchronous. Off when there is no valid input.

WCLK IN FOR SRC: Illuminated when sampling frequency is detected. Off when there is no valid input.

2 Redundant button

When this button is on, Redundant is enabled.

NOTE

When the Redundant button is on, the Input Mode button is disabled. MADI1 (Channel 1-64) is Primary and MADI2 (Channel 1-64) is Secondary.

3 Split button

When this button is on, the input signal is split and sent to output. The destination is the output terminals within the same system.

The input signal to MADI 1 IN is split to MADI 1 OUT, and the input signal to MADI 2 IN is split to MADI 2 OUT.

NOTE

When the Split button is on, the Output Mode button is disabled.

4 **Input Mode button**

Selects the input signal setting.

• **Mode1**

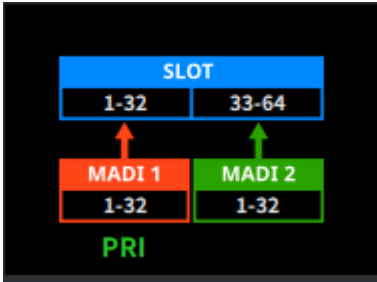

The MADI1 (Channel 1-32) signals are input to Slot 1-32, and the MADI2 (Channel 1-32) signals are input to SLOT 33-64

• **Mode2**

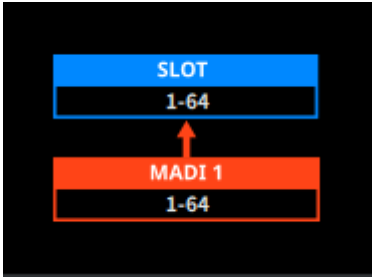

Inputs the MADI1 (Channel 1-64) signal

• **Mode3**

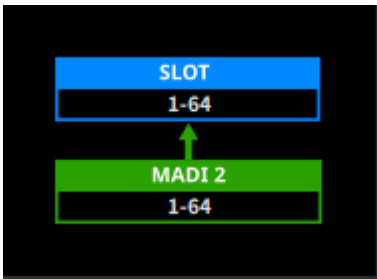

Inputs the MADI2 (Channel 1-64) signal

5 Output Mode button

Selects the output signal setting.

• **Mode1**

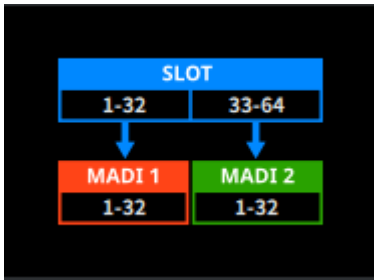

The SLOT 1-32 signals are output to MADI1 (Channel 1-32), and the Slot 33-64 signals are output to MADI2 (Channel 1-32)

• **Mode2**

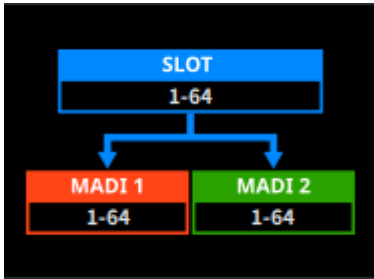

The SLOT 1-64 signals are output to both MADI1 and MADI2

6 Input SRC button

Selects SRC on/off for the input signal.

7 Input SRC Clock button

Selects the clock for the input signal when SRC is on.

• **MADI In**

Sets the MADI IN clock to SRC clock

• **WCLK In**

Sets the WCLK IN FOR SRC clock to SRC clock

8 Input Fs indicator

This displays whether the input signal is 48kHz system or 44.1kHz system. Turns off when there is no valid input signal.

9 Input Rate button

Selects the input signal rate.

• **1Fs**

44.1 kHz/48 kHz, maximum of 64 channels

• **2Fs**

88.2 kHz/96 kHz, maximum of 32 channels

• **4Fs**

176.4 kHz/192 kHz, maximum of 16 channels

10 Input Frame indicator

This displays the input signal's Frame format. Turns off when there is no valid input signal.

11 Input Channel indicator

This displays the input signal's Channel format. Turns off when there is no valid input signal.

12 Output SRC button

Selects SRC on/off for the output signal.

13 Output SRC Clock button

Selects the clock for the output signal when SRC is on.

• **MADI In**

Sets the MADI IN clock to SRC clock

• **WCLK In**

Sets the WCLK IN FOR SRC clock to SRC clock

14 Output Frame button

This displays the output signal's Frame format.

• **Same As Input**

Outputs in the same Frame format as MADI IN

• **96k**

Outputs in 96k Frame format

• **48k**

Outputs in 48k Frame format

15 Output Channel button

This sets the output signal's Channel format.

• **Same As Input**

Outputs in the same Channel format as MADI IN

• **64**

Outputs in 64 channels

• **56**

Outputs in 56 channels

PY8-AE screen

Input

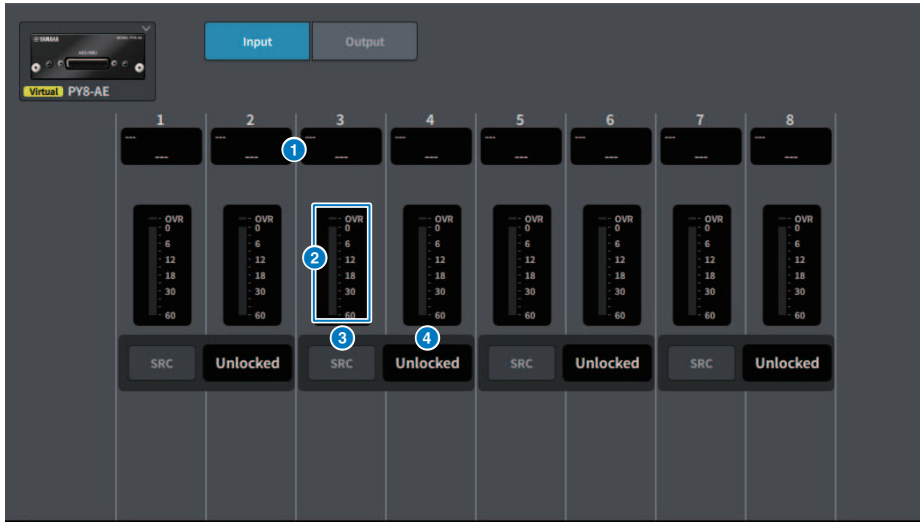

The screen contains the following items.

- 1 Patch display**
Displays the channel that has been patched.
- 2 Level meter**
This shows the input level.
- 3 SRC button**
Switches the sampling rate converter on/off for each pair of channels.
- 4 Clock status display**
Displays the status of the input signal.

Output

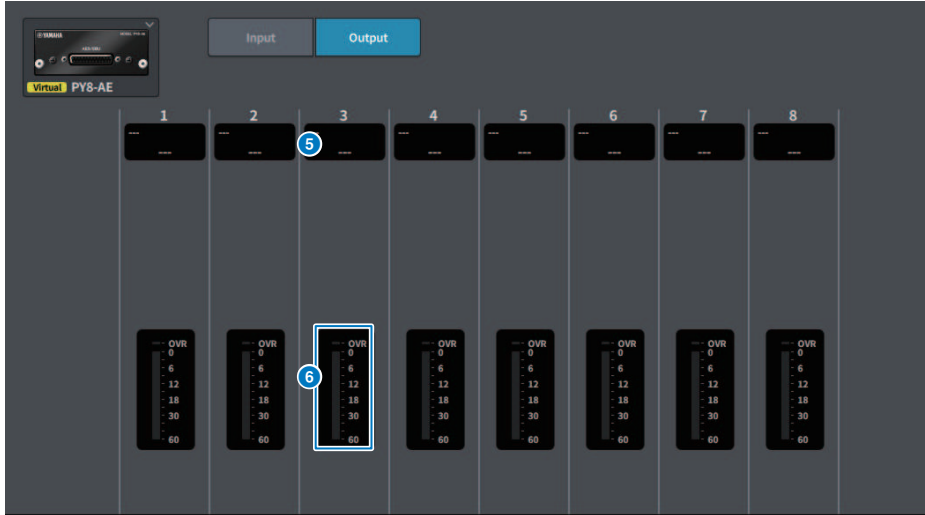

The screen contains the following items.

- 5 Patch display**
Displays the channel that has been patched.
- 6 Level meter**
Displays the output level of the signal

PY64-D screen

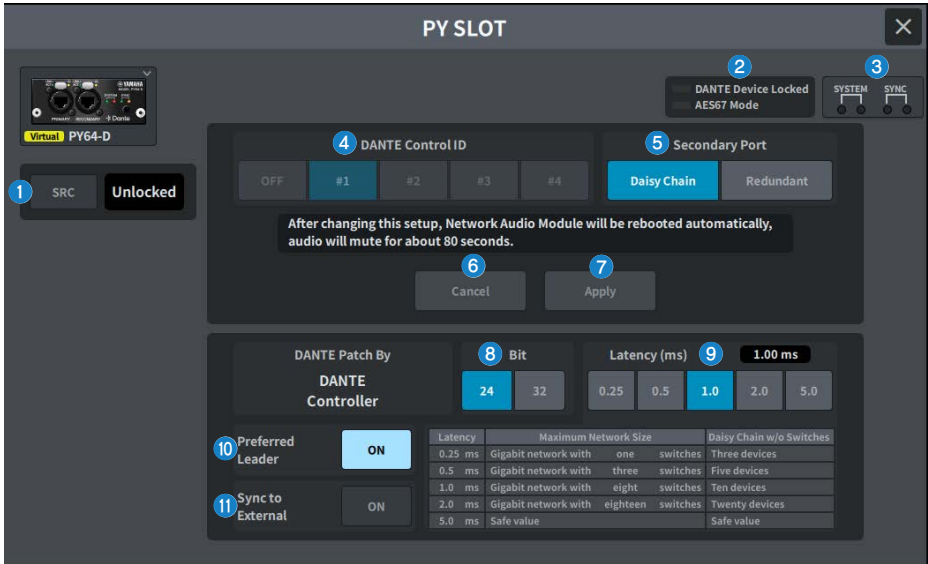

The illustration shows the screen when a PY64-D card is selected. The screen contains the following items.

1 SRC button

Turns SRC on or off and displays the clock synchronization status.

2 Status indicator

• DANTE Device Locked

The indicator is lit red if the DANTE Device Locked function is enabled, preventing the audio network settings of the Dante device from being changed.

• AES67 Mode

The indicator is lit green if AES67 (audio network compatibility connection standard) mode is enabled.

3 SYSTEM/SYNC indicator

These indicators show the Dante operational status. Press this to display the messages. In patterns where a message is displayed, an error icon or information icon is displayed next to the indicator.

4 DANTE Control ID buttons

These buttons are linked to the ID setting on the Dante Setup screen of the console.

5 Secondary Port select buttons

Select the Dante audio network connection method: either the daisy chain connection used for simple systems with a small number of connected devices, or the redundant connection used when connecting multiple devices.

6 Cancel button

This cancels the temporarily edited content during the process of editing DANTE Control ID or Secondary Port.

7 Apply button

If you have edited the DANTE Control ID setting or the Secondary Port setting, the settings are applied when you press this button, and a dialog box appears for confirming the change.

8 Bit select button

For selecting either 24 bits or 32 bits as the bit rate of the Dante audio network.

9 Latency select buttons

For selecting from 0.25 ms, 0.5 ms, 1.0 ms, 2.0 ms, or 5.0 ms for the latency of the Dante audio network.

10 Preferred Leader button

When set to ON, this increases the unit's order of priority for being the leader within the Dante audio network.

11 Sync To External button

When this is set to ON, the unit will sync to the word clock supplied from the external clock source.

This button is automatically set to ON if the word clock supplied from the WORD CLOCK IN terminal or AES/EBU IN on the rear panel is used as the clock source.

NOTE

• **WORD CLOCK screen**

- When SRC is on, PY64-D cannot be set as the clock source. Also, when PY64-D is the clock source, SRC cannot be turned on.
- The only sampling frequencies that can be changed from the DM7 series are DANTE 96kHz and DANTE 48kHz. Set all other frequencies using Dante Controller.
- When a sampling frequency other than DANTE 96kHz or DANTE 48kHz is selected, the sampling frequency and pull-up are displayed. If SRC is off at that time, the clock status will be Unlocked.

DM7 CONTROL SETUP Screen

Make DM7 Control settings.

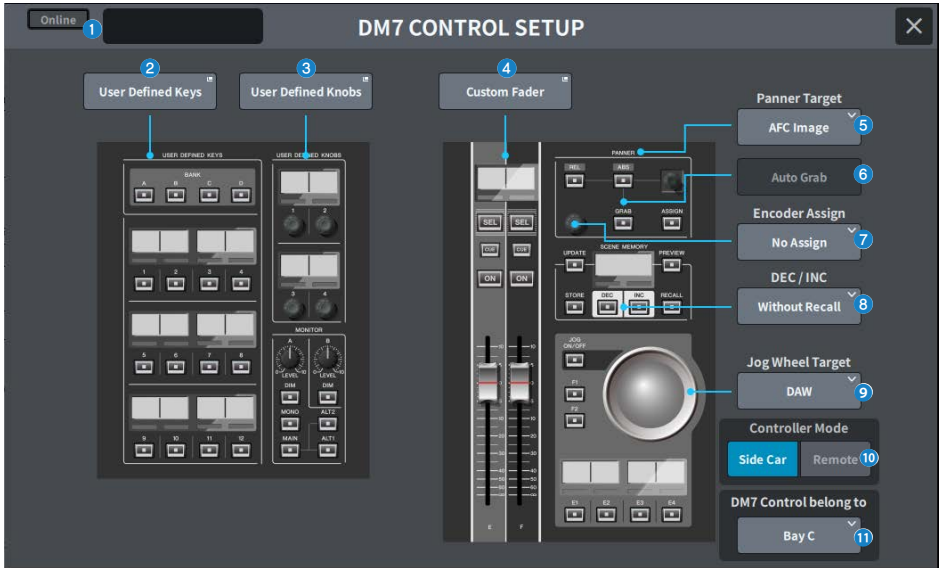

1 Status display

Connection status indicator

Displays the connection status of DM7 Control.

- When not connected

Offline

- When connected

Online

Power status warning indicator

Appears when there is a disabled DM7 Control power supply.

- When AC IN is disabled

NO AC

- When DC IN is disabled

NO EXT DC

Status display

Displays the status of DM7 Control. Displays the update progress when DM7 Control is in update mode.

2 User Defined Keys button

Press this button to display the USER DEFINED KEYS screen.

3 User Defined Knobs button

Press this button to display the USER DEFINED KNOBS screen.

4 Custom Fader button

Press this button to display the CUSTOM FADER screen.

5 Panner Target selection button

Select the Panner operation target.

- AFC Image (requires Theater Package)
- 5.1 Surround (requires Broadcast Package)

6 Auto Grab button

Specifies whether to automatically grab when approaching the actual parameter when operating with the Panner.

Value	Explanation	Default
Off	No Auto Grab	
On	Auto Grab	○

7 Encoder Assign selection button

Select the Encoder operation target. The selection changes depending on which Panner Target selection button is selected. Sets the Encoder Assign to the corresponding default value when the Panner Target changes.

If Panner Target is AFC Image

- No Assign
- Z
- Width
- Height
- REV Send

If Panner Target is 5.1 Surround

- No Assign
- DIV
- LFE

8 DEC/INC selection button

Select the behavior when the DEC button and INC button are operated.

- Without Recall
No recall after DEC/INC
- With Recall
Recall after DEC/INC

9 Jog Wheel Target selection button

Select the Jog Wheel operation target.

- DAW
- Scene List
- Touch and Turn

10 Controller Mode selection button

Select the purpose of DM7 Control.

	Explanation	Default
Side car	Expand and use the DM7 main unit controls	<input type="radio"/>
Remote	Use separated from the DM7 main unit	

In Remote mode, the following DM7 main unit interlocking and linked operations are inhibited.

- Confirmation display on the DM7 main unit during SCENE MEMORY UPDATE, and RECALL
- Selected Scene changes on the DM7 main unit by Scene List operation
- Touch and Turn operations with Jog Wheel Target
- Brightness setting

11 DM7 Control belongs to selection button (DM7 only)

Select the target Bay for [SEL], Scene List, etc.

- Bay C
- Bay L

NOTE

DM7 Compact is fixed to Bay C.

PATCH Screen

Grid screen

Set the patches to input and output channels.



1 Universe View button

Press this to display the Universe screen.

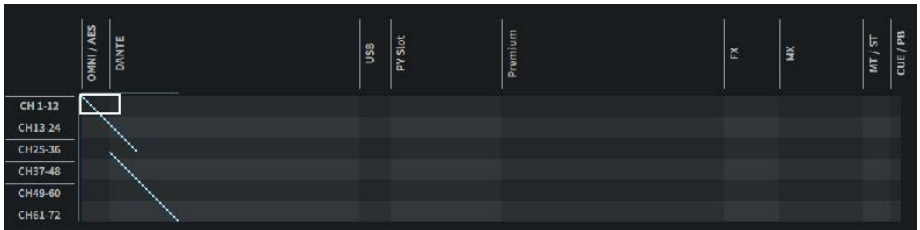

This gives you a bird's eye view of the entire setup. Moving the white frame changes the patch being displayed.

2 Clear All button

Press this button to clear all patches.

3 SHOW PORT button

Switches between displaying Port A and Port B on the grid.

4 Continuous Patch button

Press the continuous patch button, and then rotate the knob to continuously patch the target channel on a one-to-one basis. When you press the continuous patch button, the OK button and the NG button are displayed. Press the OK button to confirm the selected continuous patches. Press the NG button to revert the continuous patches to their previous state.

5 Channel display

This displays the channels that will be assigned to the I/O terminals.

6 Grid

This grid allows you to patch input ports (horizontal lines) to input channels (vertical columns). Currently patched grid cells are displayed in white. Press (or click) the desired grid cell to set or disable the patch.

7 I/O ports

Displays the input/output category and the channel number of the input/output port.

8 Grid View

Press this button to display the Grid screen.

Input patch screen (list screen)

Makes various settings for the input channels.

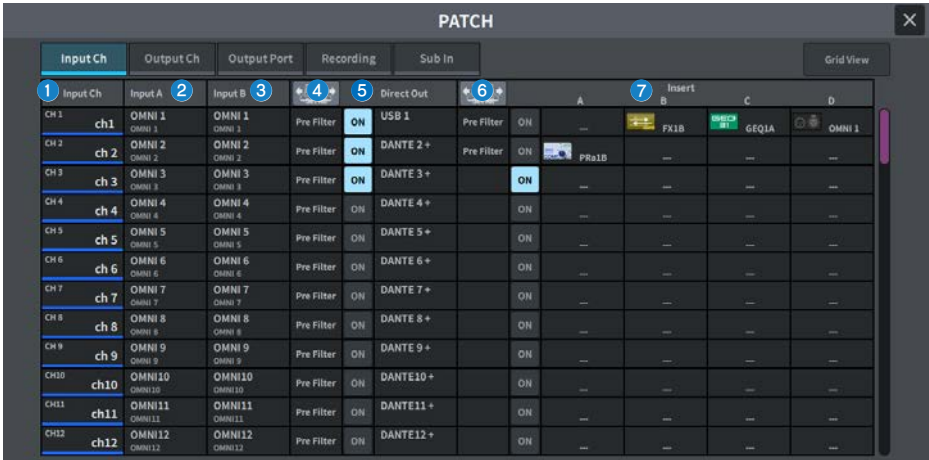

1 Channel display

Displays the channels that will be assigned to the input port.

2 Input A button

Displays the input channel Patch A.

Press this button to display the patch selection screen.

3 Input B button

Displays the input channel Patch B.

Press this button to display the patch selection screen.

4 Direct Out point

Allows you to select the signal extraction point as Pre Filter, Pre DYN1, Pre Proc, Mid Proc, Pre Fader, Post Fader and Post On.

Press the Set All button for batch setting.

5 Direct Out button

Displays the port to which the input channel signal is directly output. If nothing is selected, the button displays ----. Press this button to display the patch selection screen.

Press the ON button to turn DIRECT OUT on/off.

6 Insert point

Allows you to select the signal extraction point from Pre Filter, Pre DYN1, Pre Fader and Post On.

Press the Set All button for batch setting.

7 Insert block button

This displays the four plug-ins that have been assigned to Insert . If nothing is selected, the button displays ----. Press this button to display the plug-in selection screen.

Press the ON button to turn Insert on/off.

Patch selection screen



1 Clear Patch button

This clears the selected patch.

2 Sequential Patch

This specifies the number of patches set in Sequential Patch that continue from the channel selected on the Patch Screen.

Output patch screen (list screen)

Makes various settings for the output channels.

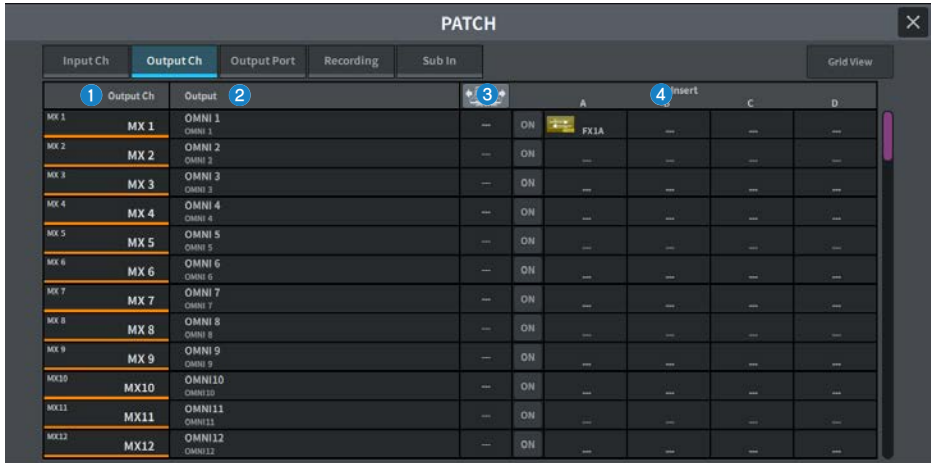

1 Channel display

Indicates the channels that will be assigned to the output port.

2 Output button

Displays the patches to output channels.

Press this button to display the patch selection screen.

3 Insert point

Allows you to select the signal extraction point from Pre Filter, Pre Proc, Pre Delay, Pre Fader and Post ON.

Press the Set All button for batch setting.

4 Insert block button

This displays the four plug-ins that have been assigned to Insert . If nothing is selected, the button displays ----. Press this button to display the plug-in selection screen.

Press the ON button to turn Insert on/off.

Output port patch screen

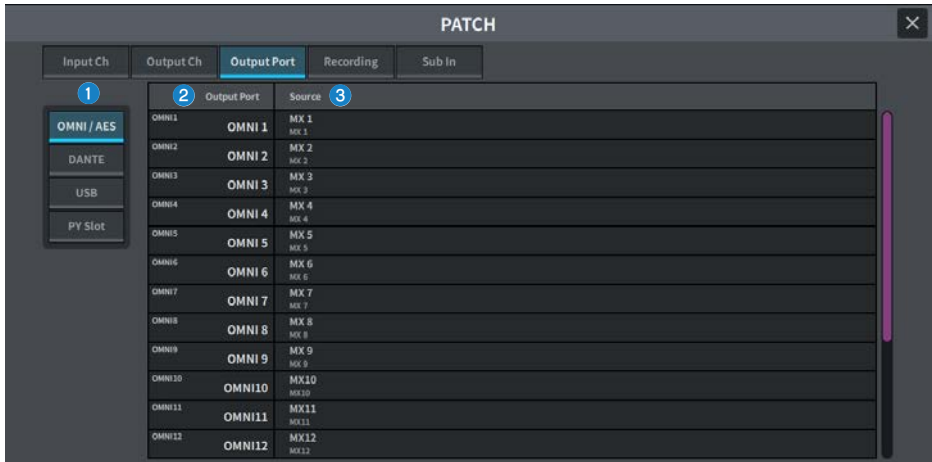

This sets the output port's patch settings

1 Output port category

Allows you to select an output port category.

2 Output Port

Displays the output port.

3 Source

Displays the source for the output port. Press this button to display the patch selection screen.

Recording patch screen

This sets the patch settings for the recorder used for Virtual Sound Check.

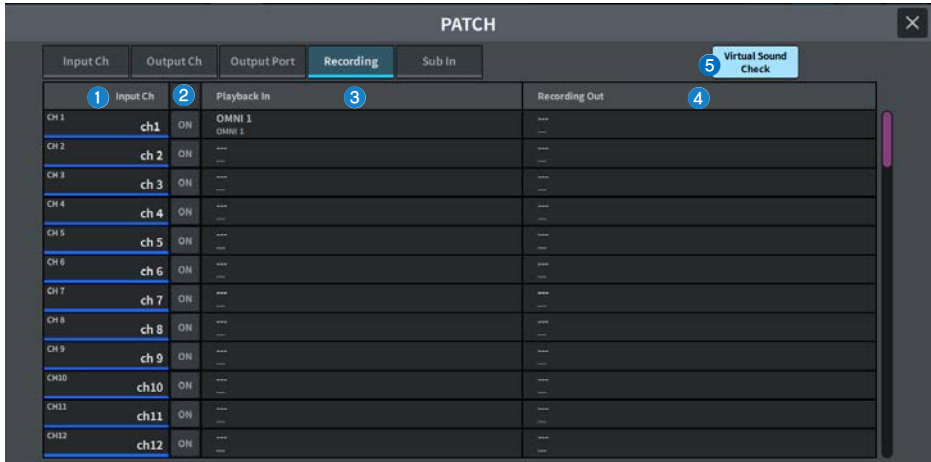

1 Channel display

Displays the channels that will be assigned to the recorder.

2 Check buttons

Allows you to add or delete channels that are subject to the virtual sound check.

The ALL button makes all channels subject to the check.

3 Playback In

Displays the patch for inputting the playback track (channel) output from a DAW, etc. to DM7 series. Press this button to display the selection screen.

4 Recording Out

Displays the patch for outputting from the DM7 series to the track (channel) input of the recorder (DAW, etc.) to be recorded. Press this button to display the selection screen.

5 Virtual Sound Check button

If this button is on, the Virtual Sound Check function is enabled, and the patches for the virtual sound check are switched.

Sub In patch screen

This sets the Sub In (routing from input port to output bus) patch settings.

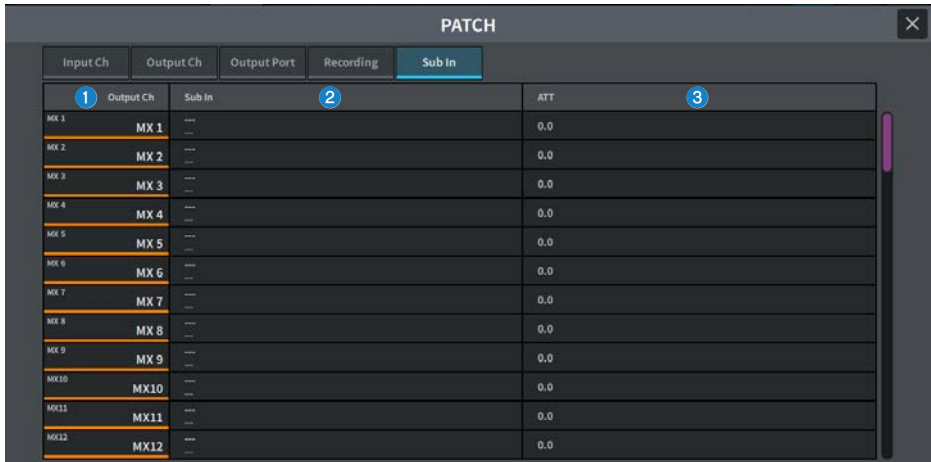

1 Channel display

Displays the channels assigned to Sub In.

2 Sub In

Displays the input source's input port. Press this button to display the selection screen.

3 ATT

Displays the gain for each channel.

I/O DEVICE Screen

DANTE SETUP (Setup) screen



This configures the Dante audio network environment.

1 Status indicator

- **DANTE Device Locked**

The indicator is lit red if the DANTE Device Locked function is enabled, preventing the audio network settings of the Dante device from being changed.

- **AES67 Mode**

The indicator is lit green if AES67 (audio network compatibility connection standard) mode is enabled.

2 SYSTEM/SYNC indicators

These indicators show the Dante operational status. Press this to display the messages. In patterns where a message is displayed, an error icon or information icon is displayed next to the indicator. For details on what the indicators show, refer to "Messages".

3 DANTE Control ID button

This sets the ID for the DM series main unit. If the ID is turned OFF, the DANTE Patch By select button is fixed to DANTE Controller, and Dante patching cannot be controlled. Additionally, the mounted I/O DEVICE remote functionality is disabled. If you specify ID #1, the shared settings (Bit/Latency/Word Clock) are also applied to the mounted I/O racks.

NOTE

Assign different IDs to the digital mixing consoles on the Dante audio network.

4 Secondary Port select buttons

Select the Dante audio network connection method: either the daisy chain connection used for simple systems with a small number of connected devices, or the redundant connection used when connecting multiple devices.

5 Cancel button

This cancels the temporarily edited content during the process of editing DANTE Control ID or Secondary Port.

6 Apply button

If you have edited the DANTE Control ID setting or the Secondary Port setting, the settings are applied when you press this button. A dialog box is displayed for you to confirm the change.

7 DANTE Patch By select buttons

When the This Console button is selected, Dante patching can be modified from the DM7 Series. When the DANTE Controller button is selected, Dante patching cannot be controlled.

8 Bit select button

These buttons select either 24 bits or 32 bits as the bit rate of the Dante audio network.

9 Latency select button

Select from 0.25 ms, 0.5 ms, 1.0 ms, 2.0 ms, or 5.0 ms for the latency of the Dante audio network.

10 Preferred Leader button

When turned ON, this increases the unit's order of priority for being the leader within the Dante audio network.

11 SYNC TO EXTERNAL button

When this is set to ON,, the unit will sync to the word clock supplied from the external clock source.

NOTE

When using PY64-D, set it manually to match the clock setting of the Dante audio network.

12 Dante Domain Manager field

Displays the status of Dante Domain Manager (DDM). This is displayed if a DDM server exists on the network or if the DM7 series is part of a domain. Press this to display the DANTE DOMAIN MANAGER screen.

State

Indicates the status of joining the domain.

- **Disconnected:**
DDM server is not on the same network
- **Unmanaged:**
DDM server is on the same network but is not part of the domain
- **Domain:**
DDM server is on the same network and is part of the domain

Local

Displays the status of the Dante settings (including Dante patching) on the DM7 series.

- **Read Write:**
Can be modified.
- **Read Only:**
Cannot be modified.

Remote

Displays the control status of the Dante settings (including Dante patching) for devices on the DM7 series network.

- **Read Write:**
Can be modified.
- **Read Only:**
Cannot be modified.
- **None:**
Cannot discover or change devices.

User

Displays the user name when logged in to DDM.

- **When not logged in**
Displays "Logout"
- **During the login process**
Displays "Logging in..."
- **When logged in**
Displays the user name

DANTE DOMAIN MANAGER screen

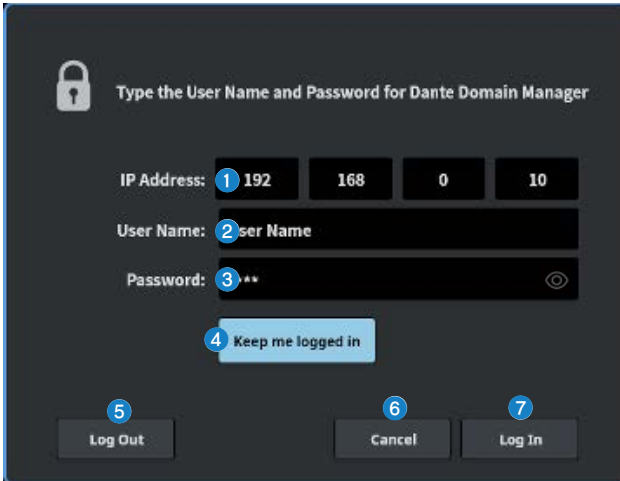

Log in to the Dante Domain Manager (DDM) on the DANTE DOMAIN MANAGER screen.

1 IP Address

Enter the IP address of the DDM.

2 User Name

Enter the DDM user name.

3 Password

Enter your password.

The password can be shown/hidden using the icon.

4 Keep me logged in button

If this is turned on, you will be automatically logged in with the same user name and password the next time you connect to the DDM server.

5 Log Out button

If this is turned on, a confirmation message "Log out Dante Domain Manager" [Cancel]/[OK] will be displayed, and when you press OK, you will be logged out as the current user.

6 Cancel button

Closes the window.

7 Log In button

Begins the login process to DDM and closes the window.

NOTE

- If the subnets of the For Device Control IP address on the NETWORK screen and the DDM server IP address are different, you will not be able to log in to DDM.
- As a specification of Dante Domain Manager (DDM), users who log in have privileges. This user privilege works only when enrolled in a domain.
- ① Site Control ② Domain Control ③ Media Control ④ Read Only ⑤ None
- The privileges that allow full control of the DM3 series are ① to ③. If you log in using Read Only in ④, you will only be able to view the settings and cannot change patches from the DM7 series. If you log in using None in ⑤, you will not be able to control or monitor. Therefore, it is not possible to check DANTE PATCH or change patches.

Related links

- Dante
- DANTE PATCH screen

DANTE SETUP (Device Mount) screen

This selects and mounts a device from among multiple I/O DEVICES on the Dante audio network.

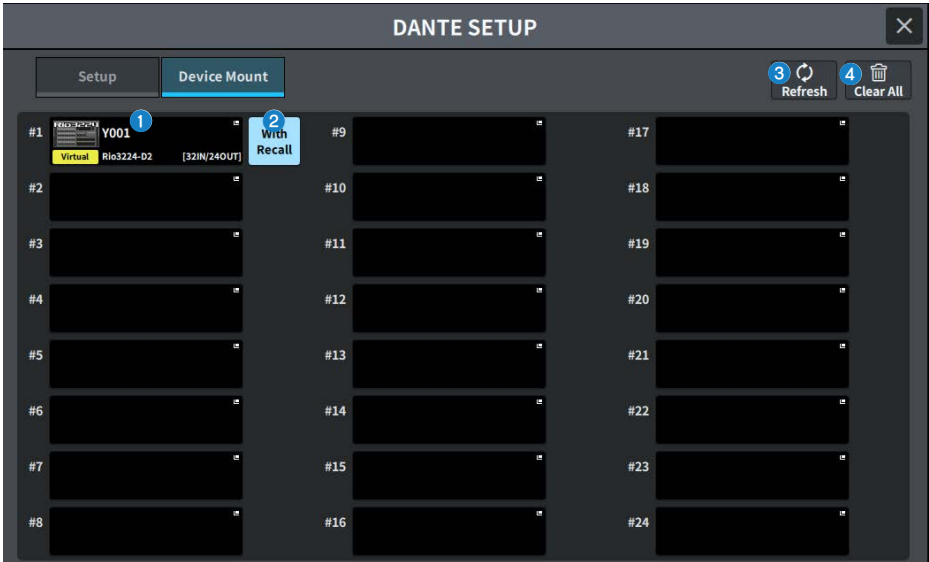

1 I/O DEVICE select button

This displays I/O DEVICE model name and number of inputs/outputs. Press to display the DEVICE SELECT screen to mount the I/O DEVICE or the corresponding DANTE I/O DEVICE screen.

2 With Recall button

When on, the information saved in the DM7 Series unit is applied to the HA device when scene recall is performed while connected to the applicable I/O DEVICE. If the R series START UP MODE is set to "REFRESH", mute is canceled after the initial HA parameter synchronization is completed.

3 Refresh button

Press this to update the I/O DEVICE information on the Dante audio network to the latest state.

4 Clear All button

Press this to unmount (cancel the mount) for all displayed I/O DEVICES.

DEVICE SELECT screen

This screen includes several pages, which you can switch between using the buttons located at the top of the screen.

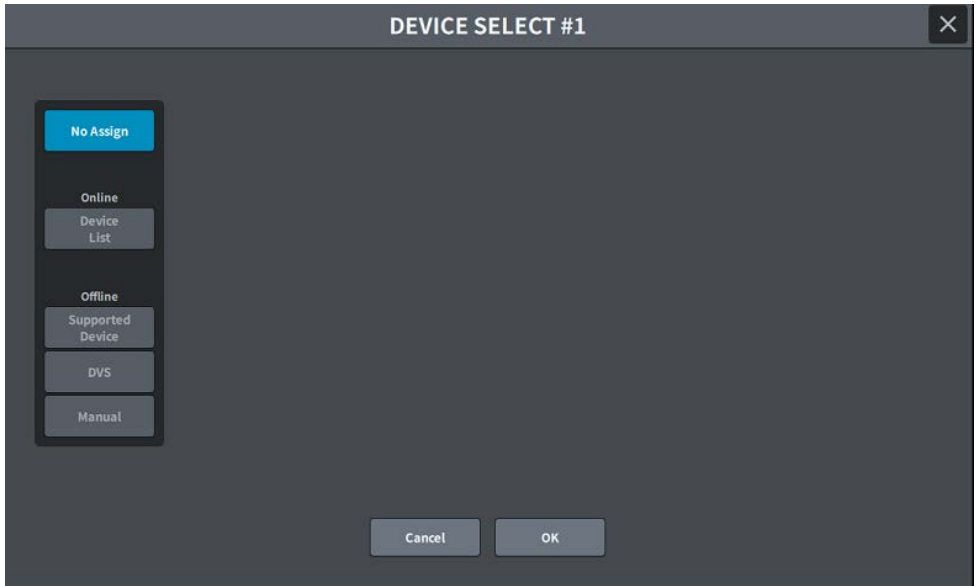

No Assign

Unmounts device

Device List

Select and mount from the online I/O DEVICES

Supported Device

Select and mount from the supported devices list

DVS

Enter a device label and mount (only for Dante Virtual Soundcard)

Manual

Enter a device label and mount

DEVICE LIST screen

This selects a device from the list of I/O DEVICES on the Dante audio network and mounts it.

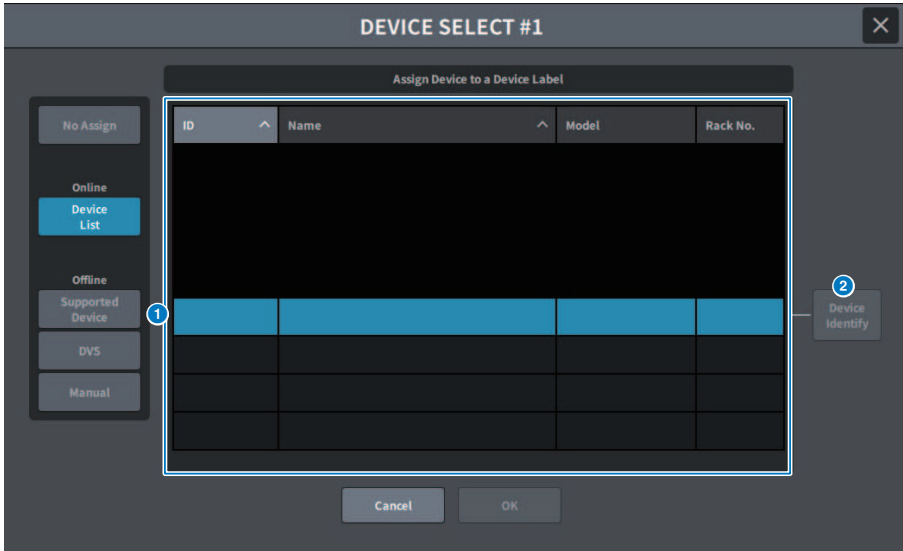

1 DEVICE LIST

This displays a list of the I/O DEVICES on the Dante audio network. Select the I/O DEVICE to mount from the list.

NOTE

After the MODEL information appears in blue text, press the OK button to mount the device. If you press the OK button before it appears in blue, the device is not recognized as a supported device. If the same I/O DEVICE with the same UNIT ID is already mounted, the OK button is disabled and the device cannot be mounted.

2 DEVICE IDENTIFY button

This is enabled for an I/O DEVICE with the DEVICE IDENTIFY function, and when pressed, the device can be recognized.

Port Identify: Pressing a [SEL] key will cause the signal indicator to flash for the port of the I/O device that is assigned to the corresponding channel by the INPUT PATCH/OUTPUT PATCH settings.

SUPPORTED DEVICE screen

You can select from supported I/O DEVICES and mount a device offline.



1 DEVICE TYPE

This displays a list of the supported I/O DEVICE types. Select the I/O DEVICE type to mount from the list.

NOTE

If the same I/O DEVICE with the same UNIT ID is already mounted, the OK button is disabled and the device cannot be mounted.

2 I/O DEVICE display

This displays the selected I/O DEVICE. This displays the model name, the number of inputs and outputs, and the remote control icon (only for supported devices).

3 UNIT ID knob

Press the screen to select, and then slide vertically/horizontally or use the [TOUCH AND TURN] knob to operate and set the UNIT ID.

DVS or MANUAL screen

Enter the device label of the I/O DEVICE and mount the device offline.

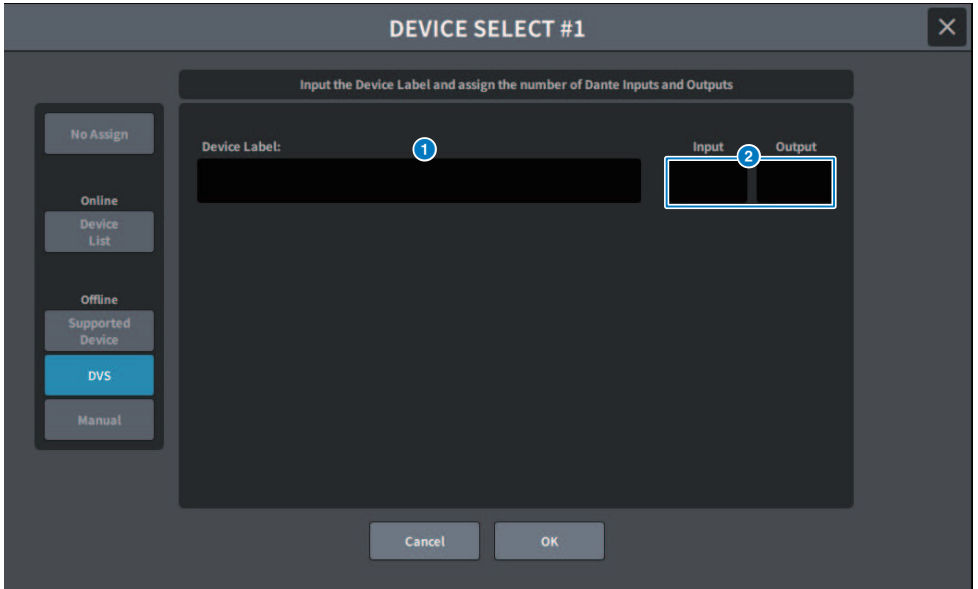

1 DEVICE LABEL

This displays the device label for the I/O DEVICE entered using the keyboard.

2 INPUT/OUTPUT

Use the keyboard to specify the number of inputs and outputs of the Dante audio network.

DANTE I/O DEVICE screen



The screen contains the following items.

1 I/O DEVICE button S

This displays the I/O DEVICE's ID number and the model name. Press to display the DEVICE SELECT screen to select the I/O DEVICE to be mounted.

2 I/O DEVICE select button

Pressing one of these displays the corresponding I/O rack, as well as the status indications (below).

Virtual Device was configured previously and does not currently exist on the Dante audio network.

Conflict A device of a different DEVICE TYPE is connected with the same ID.

Duplicate Multiple devices of the same model exist with the same ID.

Not Ctrl The DANTE Control ID of the DM series is set to OFF, and it is controlled by Dante Controller.

Secondary The DM series is configured as redundant, and is connected only via the secondary line (SECONDARY).

Locked DANTE Device Lock is set to ON.

AES67 Operating in AES67 mode.

AES Lock Operating in AES67 mode, and DANTE Device Lock is set to ON.

Guest Participating in a DDM domain, with Remote control status set to Read Only.

None Participating in a DDM domain, with Remote control status set to None.

Mismatch

The version combination of the built-in Dante module and the device on the network does not match.

NOTE

When the DANTE Setup screen's DANTE Control ID is off, the device cannot be controlled and the icon is hidden (excluding Shure Wireless Receiver).

3 I/O DEVICE display

Pressing the HA display area displays the I/O DEVICE screen, and pressing the output terminal area displays the DANTE PATCH screen's OUTPUT tab.

4 Control status icon

This displays the control status of the device.

Discovering

Searching for the device to be controlled

Declined

The device to be controlled was discovered, but the connection was refused

Connecting

Attempting to connect to the device

Synchronizing

Synchronizing with the device

Controllable

The device can be controlled

NOTE

When the DANTE Setup screen's DANTE Control ID is off, the device cannot be controlled and the icon is hidden (excluding Shure Wireless Receiver).

5 SYSTEM/SYNC indicators

These display various messages such as errors, warnings, and information.

6 REMOTE ONLY button (Rio3224-D2 and Rio1608-D2 only)

When turned on, HA operation is disabled from the I/O DEVICE panel. Only devices for which With Recall has been enabled can be turned on/off.

CONSOLE I/O Screen

Sets the internal parameters of the console.

DM7

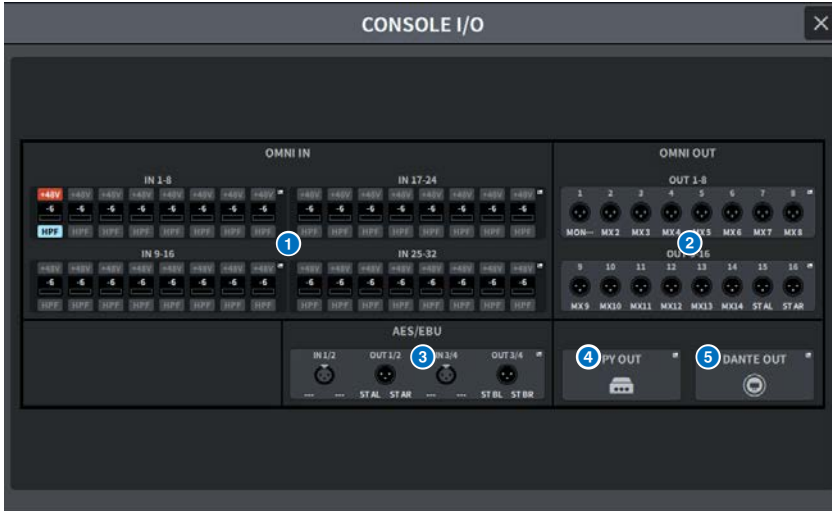

DM7 Compact

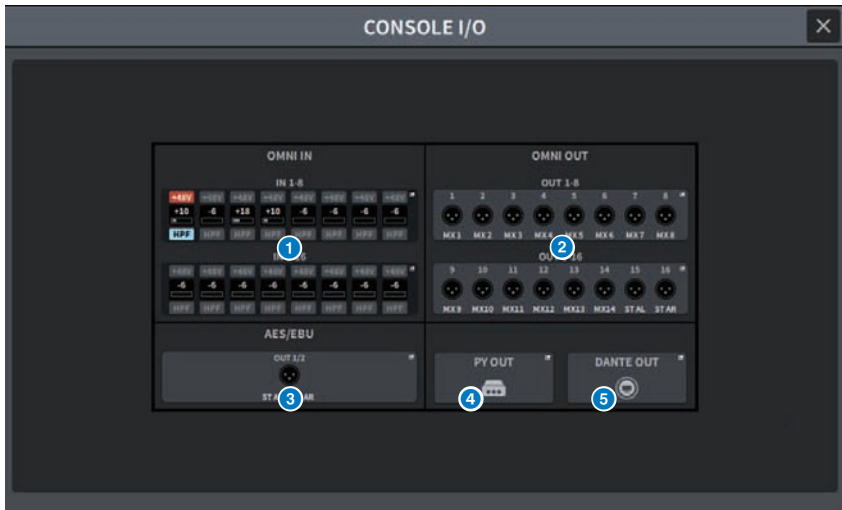

- 1 Press this to display the “OMNI IN screen” (p.189) .

Screens > I/O DEVICE Screen

- 2 Press this to display the “OMNI OUT Screen” (p.191) .
- 3 Press this to display the “AES/EBU INPUT screen (DM7 only)” (p.193) and the “AES/EBU OUTPUT Screen” (p.194) .
- 4 Press this to display the PY OUT Screen.
- 5 Press this to display the DANTE OUT Screen.

OMNI IN screen



The screen contains the following items.

- 1 **Patch display**
Displays the channel that has been patched.
- 2 **+48V button**
Switches phantom power (+48V) on/off.
- 3 **A.GAIN**
This displays the HA analog gain setting value. When the screen is pressed to select, the value can be changed by sliding vertically or horizontally or using the [TOUCH AND TURN] knob.
- 4 **GC (GAIN COMPENSATION) button**
This turns the gain compensation function on/off for each channel
- 5 **PHASE button**
This switches the phase of the input signal.
- 6 **HPF button**
Turns the high pass filter on/off for each port.
- 7 **FREQUENCY**
Sets the HPF cutoff frequency. When the screen is pressed to select, the value can be changed by sliding vertically or horizontally or using the [TOUCH AND TURN] knob.

8 M/S button

Turns the M/S decoder on/off for each pair of channels.

9 S-GAIN

Adjusts the M/S side gain. When the screen is pressed to select, the value can be changed by sliding vertically or horizontally or using the [TOUCH AND TURN] knob.

OMNI OUT Screen



This screen contains the following items.

- 1 **Patch display**
Displays the patched channel.
- 2 **Level meter**
Displays the signal level.
- 3 **PHASE button**
Switches the phase of the output signal.
- 4 **Gain**
Displays the output gain of the output port. If you press the screen to select it, you can slide it up/down, left/right, or use the [TOUCH AND TURN] knob to change the value.
- 5 **Output Load Impedance button**
Selects the load resistance of the output port. (10kΩ/600Ω)
- 6 **Assign button**
Toggles the assignment of Delay to the output port on/off.
The number of assigned resources is displayed on the left.
- 7 **View Assign button**
Press this button to display the assignment to the output port.

8 Delay setting

Displays the channel delay settings. If you press the screen to select it, you can slide it up/down, left/right, or use the [TOUCH AND TURN] knob to change the value. The current setting can be seen the top (always displayed in ms) and bottom (displayed in the currently selected scale).

NOTE

If msec (milliseconds) is selected as the DELAY SCALE, nothing will be displayed above.

9 Delay button

Switches the delay on/off.

10 Delay Scale popup button

Press this button to open the Delay Scale popup window, where you can set the delay time unit.

AES/EBU INPUT screen (DM7 only)

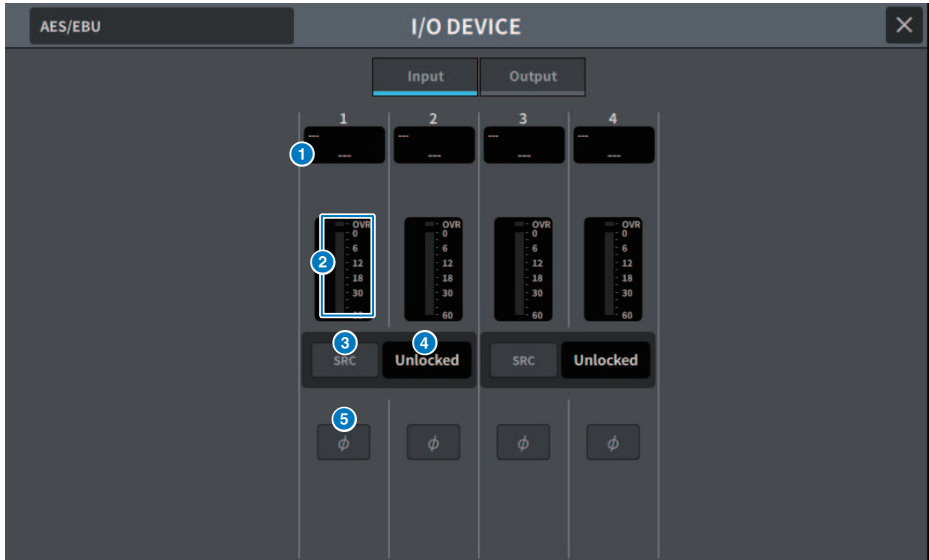

The screen contains the following items.

- 1 Patch display**
Displays the channel that has been patched.
- 2 Level meter**
This shows the input level.
- 3 SRC button**
Switches the sampling rate converter on/off for each pair of channels.
- 4 Clock status display**
Displays the status of the input signal.
- 5 PHASE button**
Switches the phase of the input signal.

NOTE

This is the parameter in the I/O DEVICE. It is different than the Φ parameter in the channel module of the control surface.

AES/EBU OUTPUT Screen



This screen contains the following items.

1 Patch display

Displays the patched channel.

2 SRC button (DM7 only)

Switches the sampling rate converter on/off for each pair of channels.

3 Sampling frequency select menu (DM7 only)

Sets the output sampling frequency when SRC is on. Select from SAME AS INPUT (same as word clock input), 44.1kHz, 48kHz, 88.2kHz, 96kHz.

4 Level meter

Displays the signal output level.

5 PHASE button

Switches the phase of the output signal.

6 Gain

Adjusts the output gain of the output port. Press to select and change the value with the [TOUCH AND TURN] knob.

7 Assign button

Toggles the assignment of Delay to the output port on/off.

The number of assigned resources is displayed on the left.

8 View Assign button

Press this button to display the assignment to the output port.

9 Delay setting

Displays the channel delay settings. If you press the screen to select it, you can slide it up/down, left/right, or use the [TOUCH AND TURN] knob to change the value. The current setting can be seen the top (always displayed in ms) and bottom (displayed in the currently selected scale).

NOTE

If msec (milliseconds) is selected as the DELAY SCALE, nothing will be displayed above.

10 Delay button

Switches the delay on/off.

11 Delay Scale popup button

Press this button to open the Delay Scale popup window, where you can set the delay time unit.

PY OUT / DANTE OUT Screen



This screen contains the following items.

1 Patch display

Displays the patched channel.

2 Assign button

Toggles the assignment of Delay/Gain to the output port on/off.
The number of assigned resources is displayed on the left.

3 View Assign button

Press this button to display the assignment to the output port.

4 Delay setting

Displays the channel delay settings. If you press the screen to select it, you can slide it up/down, left/right, or use the [TOUCH AND TURN] knob to change the value. The current setting can be seen the top (always displayed in ms) and bottom (displayed in the currently selected scale).

NOTE

If msec (milliseconds) is selected as the DELAY SCALE, nothing will be displayed above.

5 Delay button

Switches the delay on/off.

6 Delay Scale popup button

Press this button to open the Delay Scale popup window, where you can set the delay time unit.

7 PHASE button

Switches the phase of the output signal.

8 Gain

Displays the output gain of the output port. If you press the screen to select it, you can slide it up/down, left/right, or use the [TOUCH AND TURN] knob to change the value.

9 Level meter

Displays the signal output level.

I/O DEVICE screen: HA

The [TOUCH AND TURN] knob can be used to remotely control the I/O DEVICE HA.



1 Channel display

Displays the patched channels.

2 +48V button

Switches phantom power (+48V) on/off.

3 A.Gain

Displays the amount of gain for the I/O DEVICE HA. When the screen is pressed to select, the value can be adjusted by sliding vertically or horizontally or using the [TOUCH AND TURN] knob. The level meter on the right side allows you to check the input level of the corresponding port.

NOTE

For devices with a wider setting range than the DM7 Series, some values cannot be set from the DM7 Series. Similarly, if the value set on the connected device side is outside the DM7 Series setting range, it will be displayed as an approximate value or a limit value.

4 GC button

Turns gain compensation on/off to maintain a constant signal level on the audio network.

5 HPF button

Turns the high-pass filter built into the HA of the I/O device on/off.

6 FREQUENCY

Adjusts the cutoff frequency for the high-pass filter built into the HA of the I/O device. When the screen is pressed to select, the value can be adjusted by sliding vertically or horizontally or using the [TOUCH AND TURN] knob.

NOTE

For devices use a different method of changing the setting value from the DM7 Series, the cutoff frequency may be set at an approximate value.

I/O DEVICE screen: WIRELESS

This sets the channel name, gain, etc. for a wireless device. Setting is not possible if the device is offline. When the device is online, the settings on the device side are reflected.



NOTE

The number of channels and the displayed content varies depending on the model.

1 Tx.ATT/Tx.GAIN

Sets the transmission level. Press to select, and the value can be adjusted using the [TOUCH AND TURN] knob. Not displayed for wireless devices that cannot be operated.

2 Channel name

Press this button to display the NAME screen used to set the channel name. The number of characters that can be set varies depending on the model.

3 Frequency

This displays the currently set RF signal frequency.

4 Rx.LEVEL/Rx.GAIN

Sets the amount of gain for the receiver. Press to select, and the value can be adjusted using the [TOUCH AND TURN] knob. The level meter on the right side allows you to check the input level. Not displayed for wireless devices that cannot be operated.

5 MUTE button

Mutes the receiver's audio signal.

6 **Signal quality meter**

Displays the quality of the RF signal being received. The vertical axis represents quality, the horizontal axis represents time, and the connection status display is updated once per second. The bar graph becomes lower when the RF signal quality decreases as a result of increased distance from the transmitter or due to interference. This is displayed in purple for Shure devices and white for all other devices.

7 **RF (Radio Frequency) signal meter**

The number of bars displayed indicates the RF signal (A/B channel) level. An active antenna indicator is displayed on the right side to indicate which antenna is active. The RF signal meter displays both A and B when in Diversity mode. In Quadiversity mode, the strongest level from A to D is displayed.

NOTE

For the relationship between the number of bars and the actual RF signal level values, please refer to the manuals from the device manufacturer.

8 **Battery indicator**

The number of bars displayed indicates the amount of remaining battery power.

NOTE

For the relationship between the number of bars and the maximum operating time, please refer to the manual from the device manufacturer.

9 **PORT ASSIGN button**

Press this button to display the screen used to specify the port to which the actual input signal has been assigned.

When the port specified by the PORT ASSIGN button is patched to a channel, control and level monitoring of the wireless device can be performed from the input channel.

NOTE

- If the target device is dismantled, the console-side parameters will return to their default values. When a new device is mounted and patched, its parameters are reflected in the main unit.
- All port assignments to the corresponding rack are removed only when an I/O Device is in the No Assign state.
- For control of any company's devices, the control parameters are not saved in scenes or files.

I/O DEVICE Screen: Amplifier

You can remotely control the amplifier in the I/O DEVICE screen.

For NEXO NXAMPmk2



1 Status indicator

Indicates the status of the device.

Status		Indicator display
Overall	Overall status of the device	
Alert	Alert	Green: Normal operation
Amp	Operating status of each amplifier channel	Yellow: Fault detection Orange: Temporary malfunction
PS	Operating status of power supply unit	Red: Malfunction that cannot be resolved
Fan	Operating status of each Fan unit	

Alert indicator display is green and red only. When an alert occurs, the indicator turns red and the alert contents are displayed at the bottom of the screen.

2 Scene

Displays the recalled scene number and title.

3 Cabinet

Displays the name of NEXO Setup selected in the NXAMP.

4 Version

Displays the firmware version of the device.

5 Input Meter

Displays both the input analog input levels and digital input levels.

6 Standby button

Switches the standby mode on or off.

7 Overmute button

Switches the over mute (mute all channels) on or off.

8 Output level meter

Displays the output level of the channel.

9 Limit indicator

Lights while the limiter for amplifier or power supply protection is applied.

10 Protect indicator

Lights while the limiter for speaker protection is applied.

11 Volume

Sets the channel volume.

12 Mute button

Switches the channel mute on or off.

13 Channel name

Displays the channel name (the speaker preset name for the NXAMP).

DANTE PATCH (Input) screen

This sets the DANTE PATCH for the inputs.

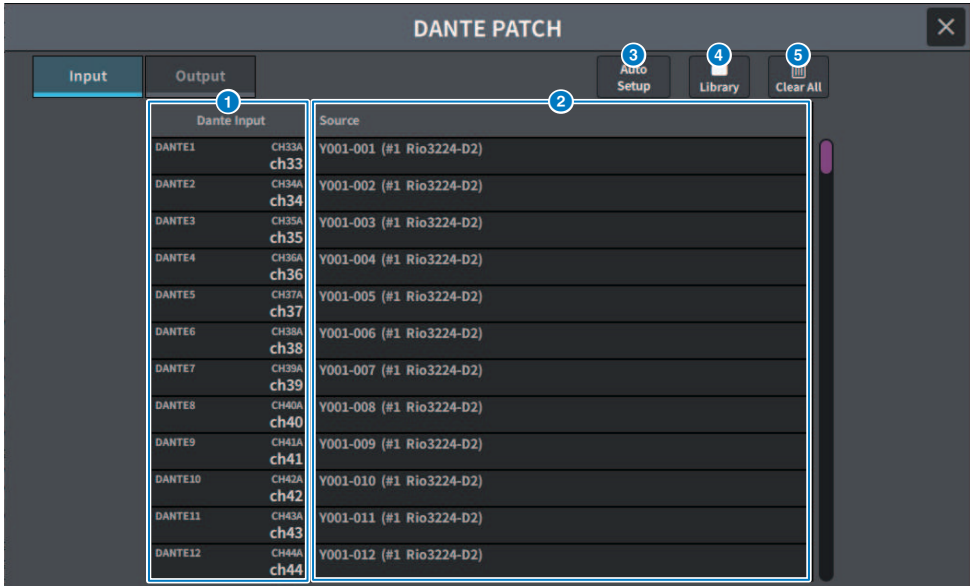

1 Dante Input

This displays the input channels.

2 Source

Press this to display a screen to select the input ports. The currently-selected port is displayed on the button.

3 Auto Setup button

Press this to automatically set up the input port.

4 Library button

Press this to display the DANTE INPUT PATCH LIBRARY screen.

A maximum of 100 input patch presets can be registered. Registering in the Library makes it easy to quickly set up patches.

5 Clear All button

Press this button to clear all patches.

DANTE PATCH (Output) screen

This sets the DANTE PATCH for the outputs.

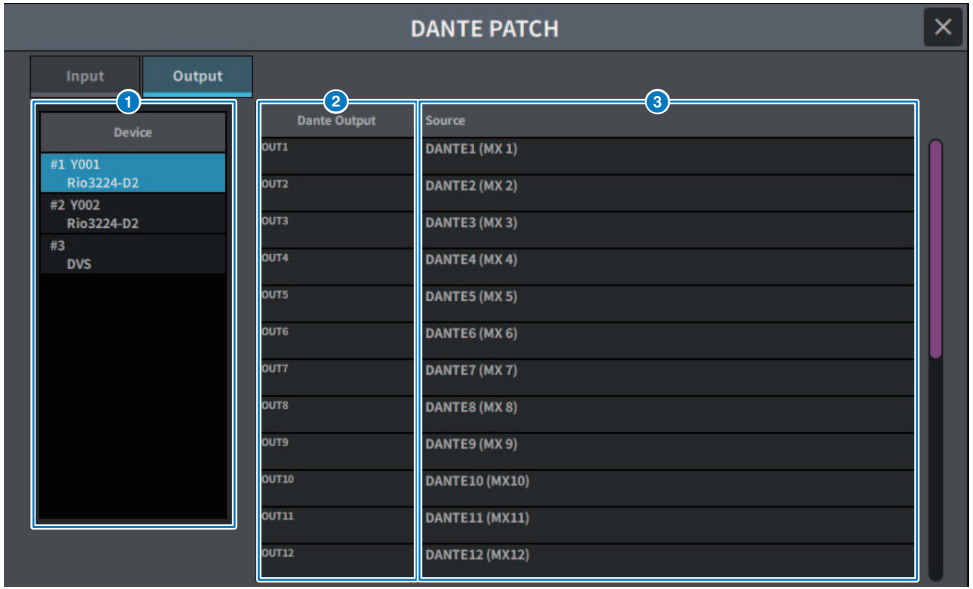

1 Device

Selects the device to set.

2 Dante Output

This displays the output channels.

3 Source

Press this to display a screen to select the output ports. The currently-selected port is displayed on the button.

RECORDER screen

RECORDER screen

Allows you to record to USB storage devices and play and manage audio files.



1 Recorder Input buttons (L/R)

Press these to display the screen, where you can select signals that will be patched to the recorder's L/R input channels.

2 Recorder Input meter

Displays the level of the signals input to the recorder.

3 Recorder Input GAIN

Sets the level of the signal input to the recorder.

4 Recorder Input CUE buttons

If CUE A, or CUE B is on, you will be able to audition the signal input to the recorder.

NOTE

You cannot turn on any of these buttons and the Playback Output CUE button simultaneously.

5 Playback Output buttons (L/R)

Press these to display the screen to select the signals to be patched to the L/R channels of the playback output.

6 Playback Output meter

Displays the level of the recorder playback output signal.

7 Playback Output GAIN

Sets the level of the recorder playback output signal.

8 Playback Output CUE buttons

If CUE A, or CUE B is on, you will be able to audition the playback signal output from the recorder.

NOTE

These cannot be turned on simultaneously with the Recorder Input CUE button.

RECORDER screen

Allows you to record to USB storage devices and play and manage audio files.



1 Title list

This is a list of the playable audio files and the folders that are saved in the selected folder of the USB drive. The column with the green background in the center of the list indicates the song file/folder that is selected for operation.

2 Status indicator

A symbol indicating whether the file is playing, paused, or recording is displayed at the left edge of the title list.

3 Track number

Displays the file number in the title list.

4 Sub-directory

If there is a folder at a lower level, a folder icon is displayed at the track number position. You can move to the lower level by pressing the folder icon.

5 Play check

When multiple songs are played back in succession, this sets whether or not the song is played.

6 Scroll bar

Scrolls up/down through the title list.

7 Display switch buttons

This button switched between the Song Title display and File Name display in the list.

8 Make Dir button

Creates a new directory in the current directory.

9 Move Up/Move Down buttons

This change the order within the list of the selected song.

10 Delete button

Deletes the selected file.

11 Save List button

Saves the order of the current title list and whether or not there is a Play check as a playlist.

12 Reload button

Loads the playlist that was most recently saved. This is used to undo edits to a playlist and revert to a previous state.

RECORDER screen

Allows you to record to USB storage devices and play and manage audio files.



TRANSPORT field

Allows you to control recording and playback of a song.

1 Current song

Displays the track number, title, and file format of the currently selected song. The display changes during playback recording.

2 Elapsed time display

Displays the elapsed playback time of the current song during playback, and the elapsed recording time during recording.

- Remaining time display

Displays the remaining playback time of the current song during playback.

3 REW button

Moves the playback point to the beginning of the current song. If already at the beginning position, moves to the beginning of the previous song with the Play check. If the playback point is not at the beginning of the current song, and if you press and hold down this button for two seconds or longer, the song will rewind. If you operate this button during playback, playback will resume from the point at which the button is released.

4 STOP button

The recorder will change from play/record/recording-standby mode to stop mode.

5 **PLAY/PAUSE button**

Changes the mode as follows:

- **Stop mode**
Moves to playback mode and starts playback from the beginning of the current song.
- **Playback mode**
Playback pause mode
- **Playback pause mode**
Moves to playback mode and starts playback from the point where it was paused
- **Recording standby mode**
Recording mode
- **Recording mode**
Recording pause mode
- **Recording pause mode**
Moves to recording mode and resumes recording from the point where it was paused.

6 **FF button**

Moves the playback point to the beginning of the next song with a Play check. If you press and hold down this button for two seconds or longer, the song will fast-forward. If you operate this button during playback, playback will resume from the point at which the button is released.

7 **REC button**

Moves to recording standby mode.

NOTE

Individual button functions can also be assigned to the USER DEFINED key.

8 **REC FORMAT/RATE button**

Allows you to select the recording file format and recording rate.

PLAYMODE Field

Allows you to specify how the recorder will behave when playback of the current song is complete.

9 **Single button**

If this button is on, only the current song will play. If this button is off, when the current song finishes playing, the next song in the list with a Play check is played.

10 **REPEAT button**

If this button is on, the playback will repeat. If the Single button is on, only the current song will play repeatedly. If the Single button is off, all songs in the list that are marked with a Play check will playback repeatedly in the order of the list. If this is off, the song will play only once.

If the Single button is on, the current song will play only once, and then stop. If the Single button is off, all songs in the list that are marked with a Play check will play once in the order of the list, and then playback will stop.

LIVE REC screen

This provides remote control of the DAW.



1 Marker list field

The marker information recorded for the current DAW (Nuendo or Cubase) project is displayed as a list. The list can be scrolled by using the [TOUCH AND TURN] knob. Press this field to display the keyboard screen used to edit the marker information.

2 Information display

Press this to display the DAW REMOTE SETUP screen to select the connection destination. Displays the information (DVS device label, IP address, USB) for the selected connection destination.

3 Add Marker button

Adds a marker to the project at the current playback position.

4 Recall Link button

Sets whether or not markers are created when a scene is recalled. The button is lit when on.

5 Playback position information display

Displays the current position information. The time display format can be changed by pressing the button on the far right.

6 Go to Project Start button

Returns the playback position to the beginning of the project.

7 Go to Previous Marker button

Returns the playback position to the previous marker.

8 Go to Next Marker button

Advances the playback position to one marker ahead.

9 Go To Project End button

Advances the playback position to the end of the project.

10 Cycle button

Turns project repeat on/off.

11 Stop button

Stops project playback/recording.

12 Play button

Starts project playback.

13 Record button

Starts/stops project recording.

14 Easy Rec button

This button immediately starts recording on all tracks. Press this to move the playback position to the last recorded position, change all tracks to record status, start recording, display the record panel and then lock the panel. Recording occurs by reversing the time set in Pre-Record Time back from the actual record start position.

15 Record lock button

Turns recording state retention on/off. Prevents accidentally stopping recording while recording is in progress.

If the STOP button is pressed while the record lock button is on, the DAW (Nuendo or Cubase) will display the confirmation "Do you want to continue recording?"

DAW REMOTE screen

The DAW REMOTE screen is used to remotely control the DAW.

If DAW1-12 or DAW13-24 is selected on the screen displayed when the [DCA/DAW] button in the fader bank on the panel is pressed, the DAW REMOTE screen is displayed.



1 Unmute All button

Press to cancel all mutes. This is lit up when there is a channel that has been muted.

2 Deactivate All Solo button

Press to clear all solos. This is lit up when there is a channel in solo status.

3 Rec Arm All button

Press to set all tracks to record status.

4 Automation Read All button

Press to set all tracks to Automation Read status. Lit when there is even one track in Automation Read status.

5 Automation Write All button

Press to set all tracks to Automation Write status. Lit when there is even one track in Automation Write status.

6 **Automation Mode select button**

For Steinberg

Selects the automation write mode.

- **Touch** Writes fader values in touch mode
- **Auto-Latch** Writes fader values in auto-latch mode
- **Cross-Over** Writes fader values in cross-over mode

For Others

Allows you to select the function for the channel's Auto button.

- **Read** Read on/off button
- **Touch** Touch on/off button
- **Latch** Latch on/off button
- **Write** Write on/off button
- **Trim** Trim on/off button
- **Off** Off button

7 **Trim button**

Switches Trim mode on/off. Lights up when turned on.

8 **Connection select button**

This displays the current connection target. Press this to display the DAW REMOTE SETUP screen.

9 **Go to Project Start button**

Returns the playback position to the beginning of the project.

10 **Go to Previous Marker button**

Returns the playback position to the previous marker.

11 **Go to Next Marker button**

Advances the playback position to one marker ahead.

12 **Go To Project End button**

Advances the playback position to the end of the project.

13 **Fast-Rewind button**

Moves the playback position backward.

14 **Fast-Forward button**

Move the playback position forward.

15 **Cycle button**

Turns project repeat on/off. Lights up when turned on.

16 Stop button

Stops project playback and recording.

17 Play button

Starts project playback. Lit during playback.

18 Record button

Starts project playback and recording. Lit during recording.

19 Information display

Displays the playback position time. When selected, the playback position can be moved using the [TOUCH AND TURN] knob.

When connected properly the DAW Remote and indicator are displayed.

20 Time format switching buttons

Switches the display format of the time shown in the information display.

21 Scrub/Shuttle buttons

Turns the function to move the playback position using the [TOUCH AND TURN] knob on/off.

- **Scrub** Outputs audio during operation
- **Shuttle** Continue in the specified direction

22 Bank switching buttons

Moves the channel to be assigned to the fader left or right in 12-channel increments.

23 Channel switching buttons

Moves the channel to be assigned to the fader left or right in 1-channel increments.

24 Level meter

Displays the channel level.

25 Automation Read button

Turns the channel Automation Read status. Lit when Automation Read status is on.

26 Automation Write button

Turns the channel Automation Write status. Lit when Automation Write status is on.

27 Monitor button

Turn the channel monitor on/off. Lit when channel Monitor is on.

28 Rec Arm button

Turns the channel record status on/off. Lit when record status is on.

DAW REMOTE SETUP screen

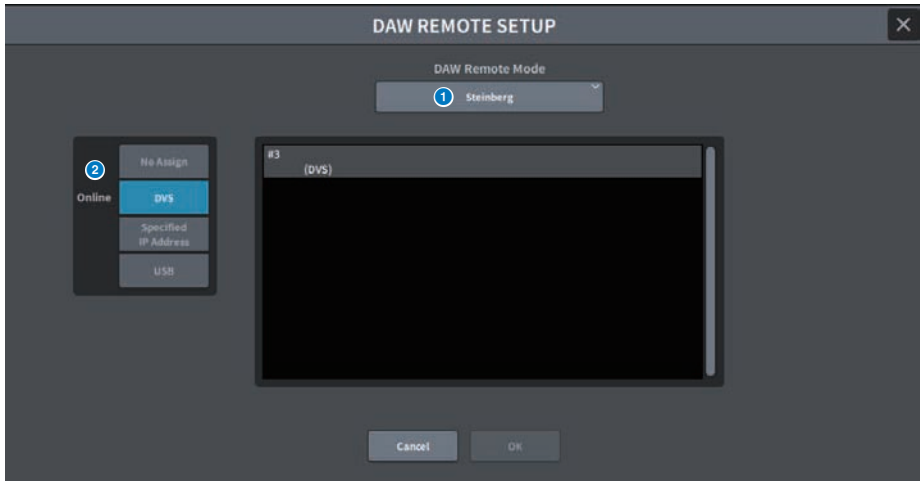

The screen contains the following items.

1 DAW Remote Mode select button

Selects Steinberg or Others for the DAW Remote Mode.

2 Connection select button

This button selects the DAW Remote and Live Rec connection destination.

- **No Assign** Not connected
- **DVS** Select DVS from the device list and connect
- **Specified IP Address** Specify the IP address of the DANTE device or computer and connect
- **USB** Connect via USB

DVS select list

This is displayed when DVS is selected with the connection destination select button.

Select DVS as the connection from the list.

IP address

This is displayed when Specified IP Address is selected with the connection destination select button.

Specify the IP address of the connection destination.

CH JOB Screen

DCA GROUP ASSIGN Screen

Sets the channel to be assigned to the DCA group. A DCA group can operate the levels for multiple channels at once.

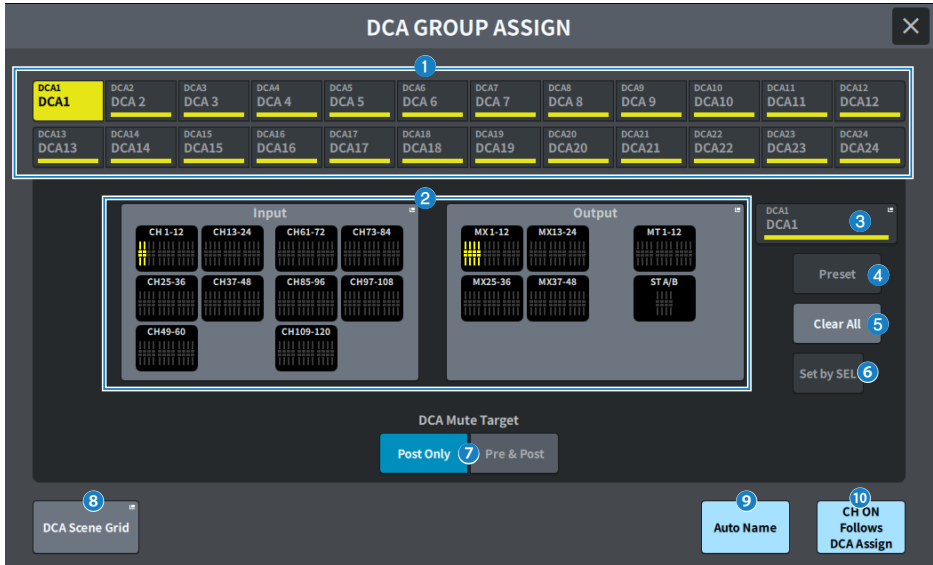

1 DCA selection buttons

Selects the DCA to be operated.

2 DCA assign field

Channels registered to the currently selected DCA are highlighted in yellow. Press this field to display the assign screen.

3 DCA display

Displays the currently selected DCA. Press to display the NAME screen used to edit the DCA name, color and icon.

4 Preset editing buttons (Theater Package compatible)

Press this button to open the Preset screen.

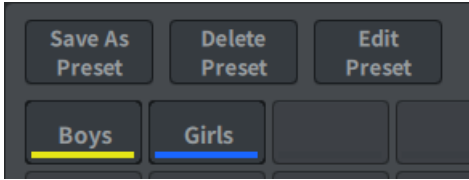

- **Save As Preset button**

Turn this button on and press the Preset button to save the currently selected DCA settings.

- **Delete Preset button**

Turn this on and press the Preset button to delete the Preset settings.

- **Edit Preset button**

Turn this on and press the Preset button to display the DCA PRESET ASSIGN screen, allowing you to select the channel to assign to the Preset.

- **Preset button**

The name and color are displayed.

5 Clear All button

Press this to clear all selections.

6 Set by SEL button

When this button is on, you can add a channel by using the corresponding [SEL] key. To select more channels, turn this button on, and then press the corresponding [SEL] keys for the channels to be added.

7 DCA Mute Target

Select Post Only, or Pre & Post. When set to Pre & Post, sends set to Pre Fader will also be muted.

8 DCA Scene Grid button (Theater Package compatible)

Press this button to display the DCA SCENE GRID screen.

9 Auto Name button (Theater Package compatible)

If this button is on, the name of the lowest-numbered channel assigned to the DCA group will be set as the DCA group name. An empty string is set when all DCA group assignments are unassigned.

10 CH ON Follows DCA Assign (Theater Package compatible)

Turning this button on will turn on the channels assigned to the DCA group. Channels that are unassigned from the DCA group are turned off. A channel-on indicator will now appear on the channel button displayed on the DCA GROUP ASSIGN screen and DCA SCENE GRID screen.

DCA SCENE GRID Screen (Theater Package Compatible)

A DCA can be assigned for each scene.

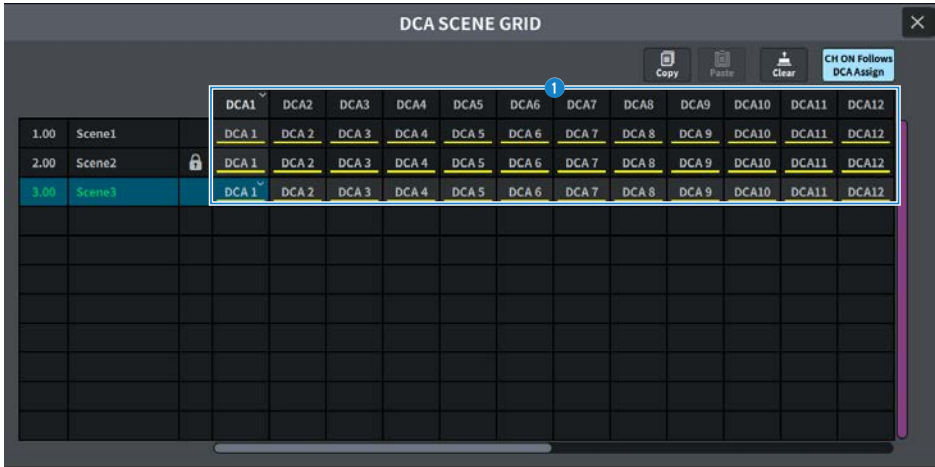

1 DCA Grid

Displays the DCA information for a specific scene. Press to display a screen for selecting the channel to assign. If you press the header at the top, you can assign the entire column.

MUTE GROUP ASSIGN screen

Sets the mute group and mute safe.

A mute group allows muting of multiple channels at the same time. Mute safe allows you to temporarily exclude specific channels registered to the mute group.

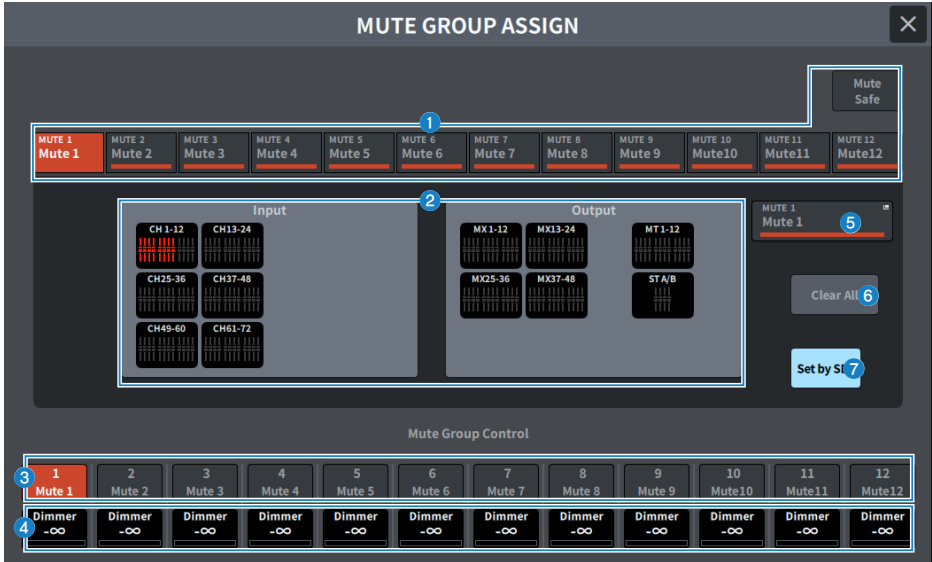

1 Mute group/mute safe select button

Allows you to select a mute group or mute safe to which you want to assign channels.

2 Mute group assign display field

This area displays the channels assigned to the currently-selected mute group.

While this screen is displayed, press the [SEL] key for the channel that you want to assign to the mute group. The channel will be assigned to the mute group, and the display for the corresponding fader for that channel will turn red. Press the same [SEL] key again to cancel the registration.

When the mute safe button is selected, the channel to be set as mute-safe is displayed. The procedure for registering or canceling a mute group is the same.

3 Mute group control button

Switches mute on/off for each mute group.

The [ON] key for each muted channel in a mute group will flash.

4 Dimmer level

Sets the level for each mute group when the Dimmer function is enabled.

NOTE

If the dimmer level is set to any level other than $-\infty$ dB, and the corresponding mute group control button is turned on, this button will be lit orange.

5 Mute group display

Displays the currently-selected mute group. Press to display the keyboard screen for editing the mute group name.

6 Clear All button

Press this to clear all selections.

7 Set by SEL button

When this button is on, you can add a channel by using the corresponding [SEL] key. To select more channels, turn this button on, and then press the corresponding [SEL] keys for the channels to be added.

CH LINK screen

Sets the function to link parameters such as fader operation and EQ for input channels or output channels.

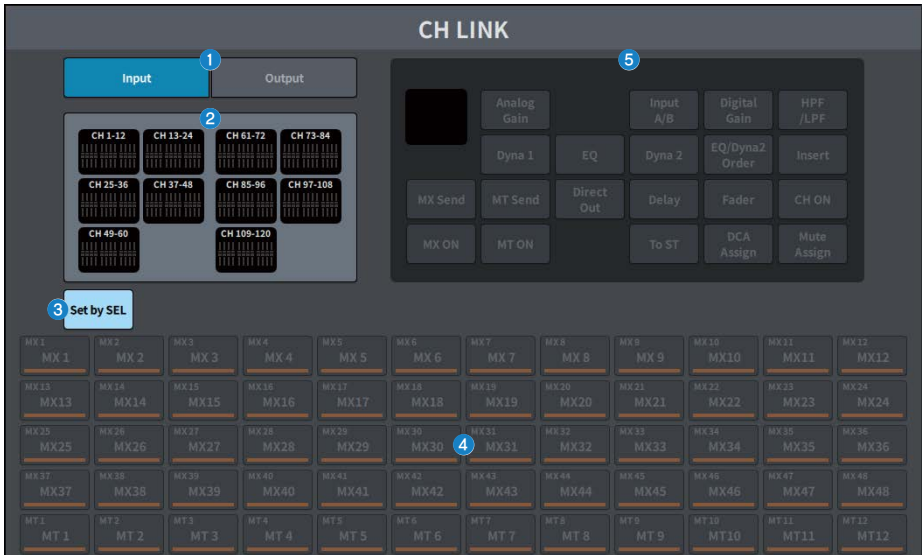

1 Input/Output buttons

These buttons switch between the input channel screen and output channel screen.

2 CH LINK display field

This displays the channels registered to the currently selected CH LINK.

Press this to display the CH LINK SET screen.

3 Set by SEL button

When this button is on, you can add a channel by using the corresponding [SEL] key.

4 Channel select button

Selects the target bus when the MX ON, MX Send, MT ON, and MT Send buttons are turned on in the linked parameters.

5 Parameter select button

Selects the parameters to link.

CH LINK SET screen



1 Input/Output buttons

Allows you to switch the input channel and the output channel.

2 Channel select button

Selects the channels you want to link. Linked channels will be displayed an alphabetical character that indicates the link group.

NOTE

- Selecting a linked channel selects all channels in the same group.
- To add a channel to a group, select the group and the channel to be added, then press the Link button.
- By selecting two groups and pressing the Link button, you can combine two groups into one group. In this case, the subsequent group is combined into the preceding group. (If you combine group A and group B, the result will be group A.)
- To unlink a channel, select the group and then press the channel that you want to remove to deselect it.

3 Link button

2 Links the channels selected in (2).

4 Unlink button

2 Unlinks the channels selected in (2).

5 Set by SEL button

When this button is on, you can add a channel by using the corresponding [SEL] key.

6 Unselect All

Clears all channel selections.

CH COPY screen

Sets the function to copy the mix parameter settings of each channel to another channel.



1 From button

It is automatically selected when you enter the CH COPY screen. Press this button if you want to select a different copy source channel.

2 To button

Selected when the mode is changed to select copy destination.

3 Paste button

After specifying the source and destination, press the button to execute channel copy operation.

4 Display channel switching button

Select the type of channels that you want to display on the screen.

5 ASSIGN section

Selects the copy source channel and the copy destination channel.

6 Set by SEL button

When this is on, you can select a channel by using the [SEL] key.

CH DEFAULT screen

Sets the function to restore the channel parameters to their default values.



1 Default button

After selecting the channel, press this button to execute the initialization operation.

2 Display channel switching button

Select the type of channels that you want to display on the screen.

3 ASSIGN section

Allows you to select the channels for which you want to restore parameters to their initial values.

4 Set by SEL button

When this is on, you can select a channel by using the [SEL] key.

MONITOR screen

MONITOR(MONITOR) Screen

Operates the signal to be checked through headphones or external monitor speakers.

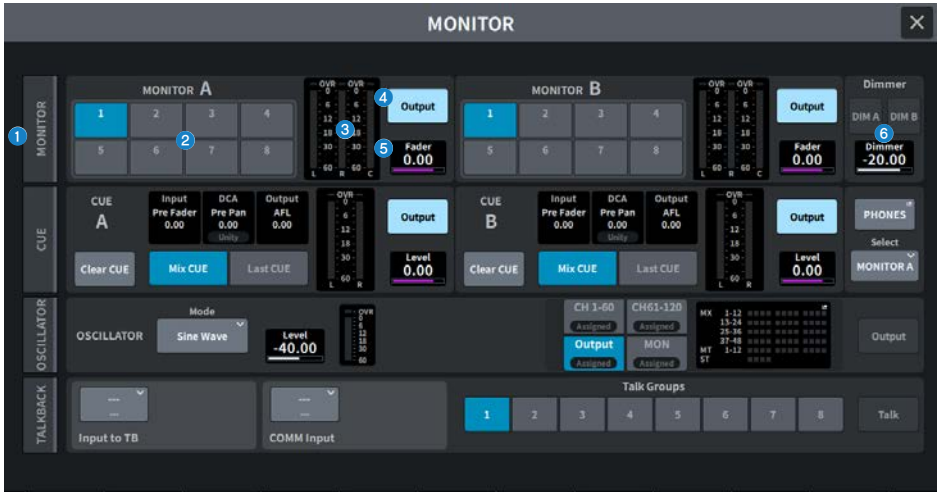

1 MONITOR tab

Displays the MONITOR screen, where you can configure advanced monitor settings. Select MONITOR A or B as the control target, and configure the settings in the corresponding field.

2 MONITOR SOURCE SELECT buttons

Allows you to select one of the DEFINE 1–8 sources that will be output to the MONITOR bus.

3 Meter field

Displays the output levels of Monitor Out L, R, and C channels.

4 Output button

Switches monitor out on/off.

5 Fader level

Adjusts the monitor fader level. Use the [TOUCH AND TURN] knob to adjust.

6 Dimmer field

Allows you to configure the settings for the Dimmer function, which temporarily attenuates monitor signals.

- **DIM A/DIM B buttons**

Turn this on to enable the dimmer and attenuate the monitor signal.

- **Dimmer level**

Adjusts the amount by which the monitor signals will be attenuated when the dimmer is on.

MONITOR Screen



This screen contains the following items.

1 Source Select button

Allows you to select from the DEFINE 1–8 sources that will be output to the MONITOR bus.

23 Mode

Selects the mode.

- **Last**

Allows you to select one of the DEFINE 1–8 sources that will be output to the MONITOR bus.

- **Mix**

Allows you to select multiple of the DEFINE 1–8 sources that will be output to the MONITOR bus.

If the number of sources is greater than 8, they cannot be selected.

2 MONITOR Delay

Displays the currently-specified delay time.

Displays the delay time of the currently selected unit and the select type of unit (scale).

3 MONITOR Delay ON button

If this is on, the monitor signal will be delayed according to the setting of the MONITOR Delay knob.

4 CUE Interrupt button

Press this to interrupt the monitor signal with the cue signal. If this button is on and the cue is enabled, the cue signal will be sent to the monitor output.

5 MONITOR Out Mode

Selects the monitor output mode from the following.

- **LR + C DOWNMIX**

In this mode, the L/C/R channel signals will be downmixed and output in stereo.

- **MONO**

In this mode, monitor signals will be output in monaural.

- **LCR**

In this mode, the L/C/R channel signals will be output.

6 Center CH ON button

If you plan not to monitor the center channel, turn this button off. If this button is off, the center channel will not be included during downmixing.

7 COMM Interrupt button

Press this button to add the COMM signal to the monitor signal. If this button is on, the COMM signal will be sent to the monitor output.

8 Meter

This field displays the output level of the monitor's L/R/C channels.

9 Insert button

Press this to display the window to insert plug-ins into the monitor signal. The currently-set plug-in inserts are displayed on the button.

10 Insert ON button

Switches the plug-in insert on/off.

11 Output Patch button

Displays the monitor output destination slot or port for the L, C and R channels respectively. Press this to display the PORT SELECT screen.

12 MONITOR Output button

Switches monitor out on/off.

13 MONITOR Fader level

Adjusts the monitor fader level.

14 Monitor Source Define button

Sets the source that will be output to the MONITOR bus.

15 Dimmer on CUE indicator

When cue is active, CUE A and/or CUE B will be lit.

16 Dimmer on CUE

Adjusts the amount by which the monitor signal will be attenuated when CUE is on.

17 Dimmer level

Adjusts the amount by which the monitor signal will be attenuated when dimmer is on.

18 DIM A/DIM B buttons

Turn this on to enable the dimmer and attenuate the monitor signal.

19 Dimmer on TB indicator

Displays the on/off status of the talkback dimmer function.

20 Dimmer on TB level

Adjusts the amount by which the monitor signal will be attenuated when talkback is on.

21 COMM level

Adjusts the COMM signal level.

22 COMM ON button

When this is on, the COMM signal is enabled.

24 MONITOR level

Displays the monitor level.

When the DM7 Control is not connected: Adjusts the monitor level with the [TOUCH AND TURN] knob.

When the DM7 Control is connected: The display disappears and the monitor level is adjusted with the DM7 Control.

25 Speaker Select buttons

Press to select the output destination Speaker.

- **MAIN**

The output destination of L, R, and C set as the MAIN Speaker is set.

- **ALT1**

The output destination of L, R, and C set as the ALT1 Speaker is set.

- **ALT2**

The output destination of L, R, and C set as the ALT2 Speaker is set.

26 Setup Speaker button

Press this button to display a screen for setting the output destinations for MAIN, ALT 1, and ALT 2.

MONITOR SOURCE DEFINE Screen

This screen allows you use the DEFINE button to register the source that will be output to the MONITOR bus.

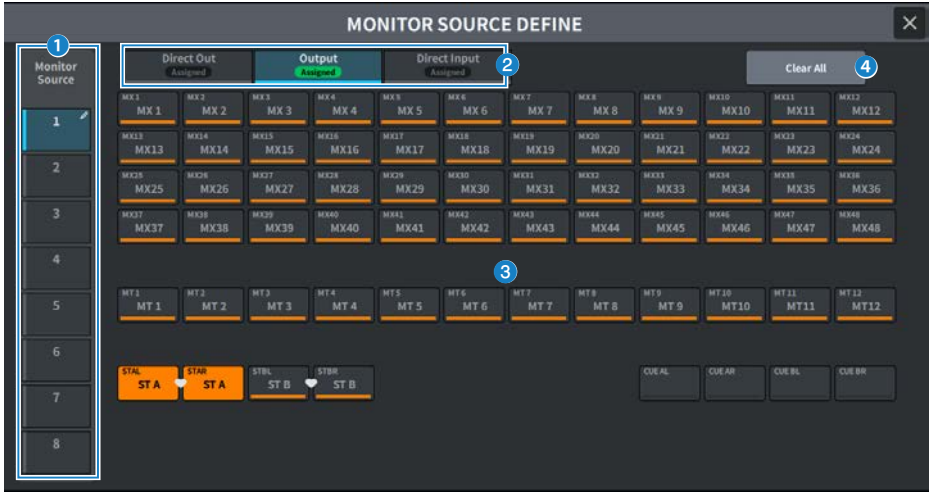

This screen contains the following items.

1 Source Select button

Allows you to select one of the DEFINE 1–8 sources that will be output to the MONITOR bus. Press to display a keyboard for naming.

2 Display switching tabs

Switches the types of channels, buses, and input ports that are displayed on the screen.

3 Monitor source selection buttons

Allows you to select monitor sources that will be assigned to the DEFINE buttons. The selected monitor sources will be highlighted. Press the same button again to cancel the selection.

4 Clear All button

Press this to clear all selections.

MONITOR (CUE) screen

Operates the CUE function used to check the sound of the selected individual channel/DCA.



1 CUE tab

Displays the CUE screen where you can configure advanced cue settings. Select CUE A or B as the operation target, and configure the settings in the corresponding field.

2 Input/DCA/Output CUE field

Displays the setting status for input cue, DCA cue, and output cue.

3 Clear CUE button

Cancels all cue selections simultaneously. If the CUE Mode setting is Mix CUE, all of the selected channels will be cleared.

4 CUE Mode buttons

Allows you to select the operation mode when the [CUE] key is on for multiple channels.

- **Mix CUE mode**
All selected channels are cued.
- **Last CUE mode**
Only most recently selected channel is cued.

5 Meter

This displays the output level of the cue L/R channels.

6 CUE Output button

This button switches cue output on/off.

7 CUE level

Displays the output level from cue out. Use the [TOUCH AND TURN] knob to adjust.

8 PHONES button

Displays the PHONES screen to set the signal to monitor using headphones.

9 PHONES Select button

Selects the signal that is monitored by the headphones.

CUE Screen



This screen contains the following items.

1 CUE Settings button

Press this to display the CUE Settings screen, where you can select the cue destination. You can select the cue destination (CUE A, CUE B, or A+B) for each channel.

2 SOLO ON button

Switches the solo operation on/off.

3 SOLO Safe button

Excludes any channel from solo operations.

4 Active CUE indicator

The type of cue currently being monitored is indicated by the lit option.

5 Clear CUE button

Cancels all cue selections simultaneously. If the CUE Mode setting is Mix CUE, all of the selected channels will be cleared.

6 Input CUE field

Allows you to configure settings related to the input channel cue.

- **Cue point selection button**

Sets the position for auditioning from PFL Pre FILTER (immediately before FILTER), Pre Fader (immediately before the fader), AFL (immediately after the fader), and Post Pan (immediately after pan).

NOTE

Be aware that if you select Post Pan, you will be unable to monitor signals sent to the MONO bus from an input channel that is set to LCR mode.

- **PFL Trim**

Sets the monitor levels when PFL is selected. Use the [TOUCH AND TURN] knob to adjust.

- **Follow Pan button**

If this button is on, the TO STEREO PAN setting will be applied to the pan setting of the signal sent from input channels to the CUE bus.

7 DCA CUE field

Allows you to configure settings related to the DCA cueing.

- **Cue point selection button**

The position for the DCA audition can be selected from Pre Pan (immediately before pan) or Post Pan (immediately after pan).

- **DCA Trim**

Displays the monitor level when cueing DCA. Use the [TOUCH AND TURN] knob to adjust.

- **Unity button**

If this button is on, the main level of each DCA is auditioned at the same volume as when set to 0 dB (unity gain).

8 Output CUE field

Allows you to configure settings related to the output channel cue.

- **Cue point selection button**

Select the position for auditioning the output channel from PFL (immediately before the fader) or AFL (immediately after the fader).

- **PFL Trim**

Displayed the monitor levels when PFL is selected. Use the [TOUCH AND TURN] knob to adjust.

9 CUE Mode buttons

Allows you to select the operation mode when the [CUE] key is on for multiple channels.

- **Mix CUE mode**

All selected channels are cued.

- **Last CUE mode**

Only most recently selected channel is cued.

10 Meter

This displays the output level of the cue L/R channels.

11 Insert button

Press this to display the window where you can insert plug-ins into the CUE signal. The currently-set plug-in inserts are displayed on the button.

12 Insert ON button

Switches the plug-in insert on/off.

13 CUE Out Mode selection button

The CUE signal output can be selected as STEREO or MONO.

14 CUE Output button

This button switches cue output on/off.

15 CUE level

Displays the output level from cue out. Use the [TOUCH AND TURN] knob to adjust.

16 CUE Output Patch button

Press this to display the PORT SELECT screen where you can select output ports to patch to the L/R channels of the cue output.

17 Fader CUE Release ON button (Broadcast Package Compatible)

When this button is turned on, the CUE for that channel will be cleared when the fader level exceeds the threshold value.

18 Fader CUE Release Threshold (Broadcast Package Compatible)

The threshold value is displayed. Use the [TOUCH AND TURN] knob to adjust it.

19 Backstop PFL ON button (Broadcast Package Compatible)

Pushing the fader below the OFF position (level is $-\infty$) turns the CUE on, and raising or releasing the fader turns the CUE off.

PHONES screen

This configures the settings related to signals monitored by the headphones.

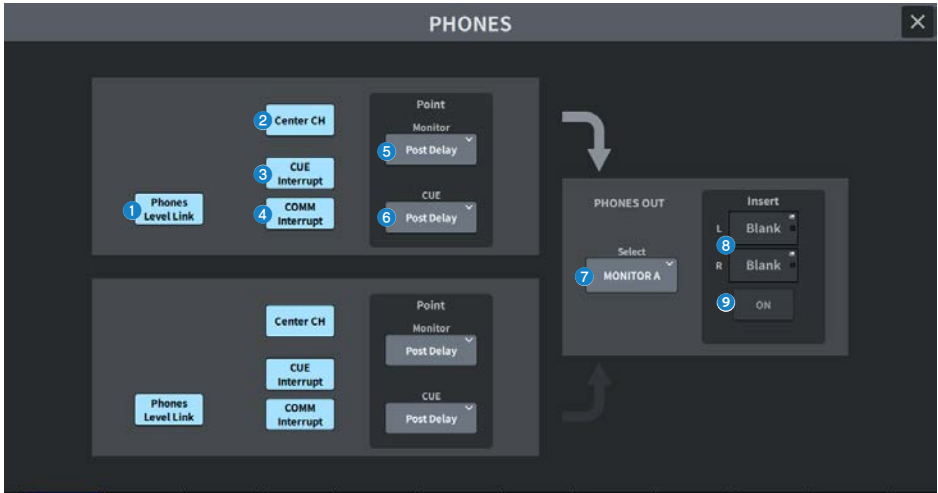

1 Phones Level Link button

If this is on, the monitor fader level is linked to the level of signals sent to the PHONES output jack.

2 CENTER CH ON button

If you plan not to monitor the center channel, turn this button off.

3 CUE Interrupt button

Switches the Cue Interrupt function on/off.

NOTE

When CUE is selected as the monitor source, it is recommended that CUE Interrupt be turned off to prevent the monitor source from being interrupted by CUE operation.

4 COMM Interrupt button

Switches the COMM Interrupt function on/off.

5 Point Monitor button

Select one of the following monitor signal source points:

- Pre Delay
- Post Delay

6 CUE Monitor button

Select one of the following cue signal source points:

- Pre Delay
- Post Delay

7 Select button

Selects the signal that is monitored by the headphones.

8 Insert button

Press this to display a screen where you can insert plug-ins into the signal monitored by the headphones.

9 Insert ON button

Switches the plug-in insert on/off.

CUE SETTINGS screen



The screen contains the following items.

1 Channel list

This displays the channels.

2 All button

Press this to apply or cancel the selected cue destination (CUE A, CUE B) for all channels simultaneously. If there is a mix of selected and unselected in that column, "... " will be displayed.

3 CUE select buttons

Allows you to select the cue destination for each channel.

MONITOR (OSCILLATOR) screen

Sends a sine wave or pink noise from the internal oscillator to any chosen bus.

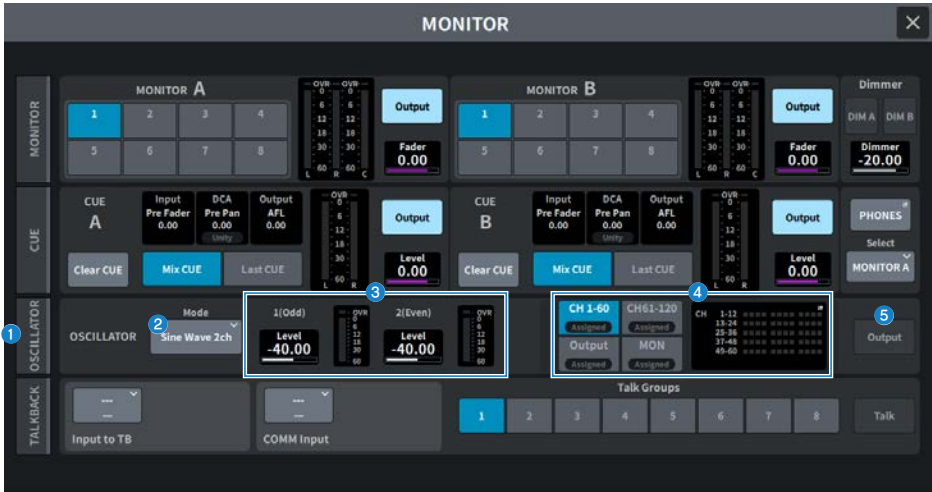

1 OSCILLATOR tab

Displays the OSCILLATOR screen where you can configure advanced oscillator settings.

2 OSCILLATOR Mode buttons

Displays the selected oscillator mode. Press this to display the screen to switch modes.

- Sine Wave
- Sine Wave 2ch
- Pink Noise
- Burst Noise

3 OSCILLATOR LEVEL field

Adjusts the oscillator levels. A meter beside LEVEL displays the output level of the oscillator. Press LEVEL to adjust the oscillator level using the [TOUCH AND TURN] knob. The range is -96.00 dB to 0.00 dB.

4 OSCILLATOR Assign field

An indicator lights to indicate the currently-selected oscillator output destination (input channels, buses or monitor). Use the buttons at the left to switch the indicator display. For buttons with any one of the channels/buses selected, the "Assigned" indicator is lit green.

5 OSCILLATOR Output button

Turns the oscillator output on/off.

OSCILLATOR screen



The screen contains the following items.

1 OSCILLATOR Mode buttons

Select one of the following four oscillator operating modes:

Sine Wave

A sine wave is output continuously.

Sine Wave 2ch

Two sine waves (with different frequencies) are output separately.

Pink Noise

Pink noise is output.

Burst Noise

Pink noise is output intermittently.

2 Parameter field

Allows you to set the oscillator parameters. The contents and functions of this field vary depending 1 on the operating mode in (1).

For **Sine Wave**

- **Level**

Displays the output level of the sine wave. This can be operated using the [TOUCH AND TURN] knob.

- **Freq**

Displays the frequency of the sine wave. This can be operated using the [TOUCH AND TURN] knob.

- **Frequency button**

Allows you to select the sine-wave frequency from 100 Hz, 1 kHz, and 10 kHz.

For **Sine Wave 2ch**

- **Level (Odd)**

Displays the output level of the odd-channel sine wave. This can be operated using the [TOUCH AND TURN] knob.

- **Freq (Odd)**

Displays the frequency of the odd-channel sine wave. This can be operated using the [TOUCH AND TURN] knob.

- **Level (Even)**

Displays the output level of the even-channel sine wave. This can be operated using the [TOUCH AND TURN] knob.

- **Freq (Even)**

Displays the frequency of the even-channel sine wave. This can be operated using the [TOUCH AND TURN] knob.

- **Frequency**

Allows you to select the sine-wave frequency from 100 Hz, 1 kHz, and 10 kHz.

The initial value is 100Hz. Two meters (odd and even) will be displayed.

For **Pink Noise**

- **Level**

Displays the output level of the pink noise. This can be operated using the [TOUCH AND TURN] knob.

- **HPF**

Displays the cutoff frequency of the HPF that processes the pink noise. This can be operated using the [TOUCH AND TURN] knob. Use the button below to switch the HPF on/off.

- **LPF**

Displays the cutoff frequency of the LPF that processes the pink noise. This can be operated using the [TOUCH AND TURN] knob. Use the button below to switch the LPF on/off.

For **Burst Noise**

- **Level, HPF, LPF**

These are the same as for Pink Noise.

- **WIDTH**

Displays the length of the intermittently output noise. This can be operated using the [TOUCH AND TURN] knob.

- **INTERVAL**

Displays the length of silence between noise bursts. This can be operated using the [TOUCH AND TURN] knob.

3 **Meter section**

This is a meter that displays the oscillator output level.

4 **OSCILLATOR Output button**

Turns the oscillator output on/off. If this on, the oscillator signal will be sent to the input channel or bus selected in the ASSIGN section. Press this again to turn oscillator off.

5 **Display channel switching button**

Select the type of channels that you want to display on the screen. CH1-60, CH61-120 (CH61-72 for DM7 Compact), Output, and MONITOR can be selected For buttons with any one of the channels/buses selected, the "ASSIGNED" indicator is lit green.

6 **Assign section**

Allows you to select a channel to which the oscillator signal will be sent. Press one of the 4 tabs to select the type of channels/buses displayed, and then press the button(s) for the desired channels/buses (multiple selections are allowed).

If Sine Wave 2ch is selected as the mode, the output signal is determined depending on whether the selected channel number is odd or even. For example, the odd-channel signal will be routed to MIX1 and the even-channel signal will be routed to MIX2. If the Clear All button is pressed, all selections can be cleared.

7 **Clear All**

Excludes all output channels from the oscillator signal destination.

MONITOR (TALKBACK) screen

The microphone signals input to the desired input port are sent to the desired bus.

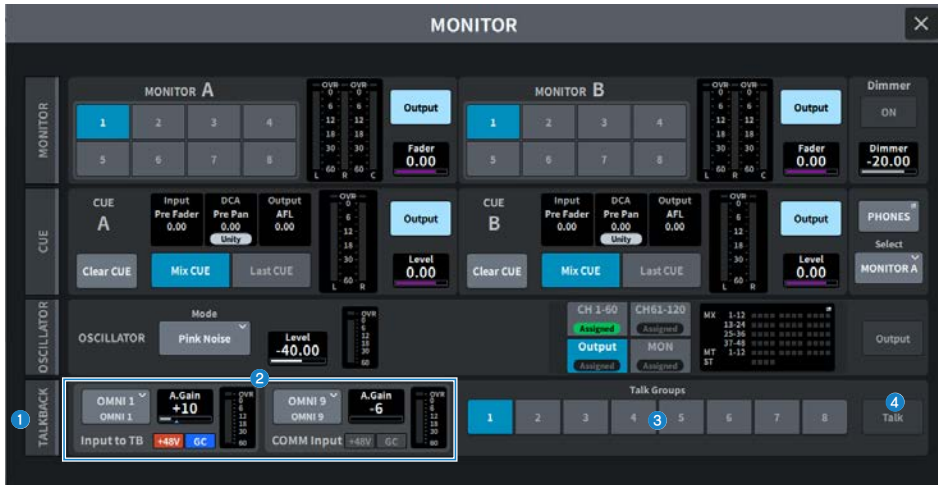

1 TALKBACK tab

Displays the TALKBACK screen where you can configure advanced Talkback settings.

2 Input to TB field, COMM Input field

• TALKBACK patch button

Press this to display the INPUT PORT SELECT screen where you can patch a desired input port/slot to Talkback. The selected port/slot name is displayed on the button. If no patch is assigned, the button will display "-----".

• A. Gain

Sets the analog gain for the corresponding input port/slot. This can be operated using the [TOUCH AND TURN] knob.

• TALKBACK +48 indicator

Displays the +48V on/off status for the corresponding input port/slot.

• TALKBACK GC indicator

Displays the on/off status of gain compensation for the corresponding input port/slot.

• TALKBACK level meter

Displays the level after passing through the input gain for the corresponding input port/slot.

3 Talk Groups button

Selects the output source set in the TALKBACK screen.

4 Talk button

Switches Talkback out on/off.

TALKBACK screen



The screen contains the following items.

1 Input to TB field, COMM Input field

• TALKBACK patch button

Press this to display the INPUT PORT SELECT screen where you can patch a desired input port/slot to Talkback. The selected port/slot name is displayed on the button. If no patch is assigned, the button will display "----".

• TALKBACK +48V button

Turns the phantom power (+48V) supplied to the corresponding input port on/off.

• A. Gain

Sets the analog gain for the corresponding input port/slot. This can be operated using the [TOUCH AND TURN] knob.

• TALKBACK GC button

Turns the corresponding gain compensation on/off when the corresponding input port is used as the talkback input.

• TALKBACK HPF

Sets the cutoff frequency for the HPF when you use the corresponding input port as the talkback input. The HPF is switched on/off using the button.

• TALKBACK level meter

Displays the level after passing through the input gain for the corresponding input port/slot.

2 Talk Groups button

This sets the output destination of the talkback signal.

3 Talkback ON button

Switches Talkback out on/off.

4 TalkbackOut patch button

Press this to display the OUT PATCH screen where you can patch any desired output port to talkback.

5 TalkbackOut ON button

This button switches talkback output on/off when you use any output port as the talkback output.

6 Assign select button

Select the output destination to be registered to the Talk Groups button.

7 Clear All button

Exclude all output channels from being the talkback output.

RACK Screen

RACK screen



The screen contains the following items.

- 1 Category select tabs**
Allows you to select the category of plug-in that will be mounted in the rack.
- 2 PLUG-IN select buttons**
Allows you to select the plug-in that will be mounted.
- 3 PLUG-IN DSP USAGE display**
Displays the state of plug-in resource usage.

GEQ Edit screen

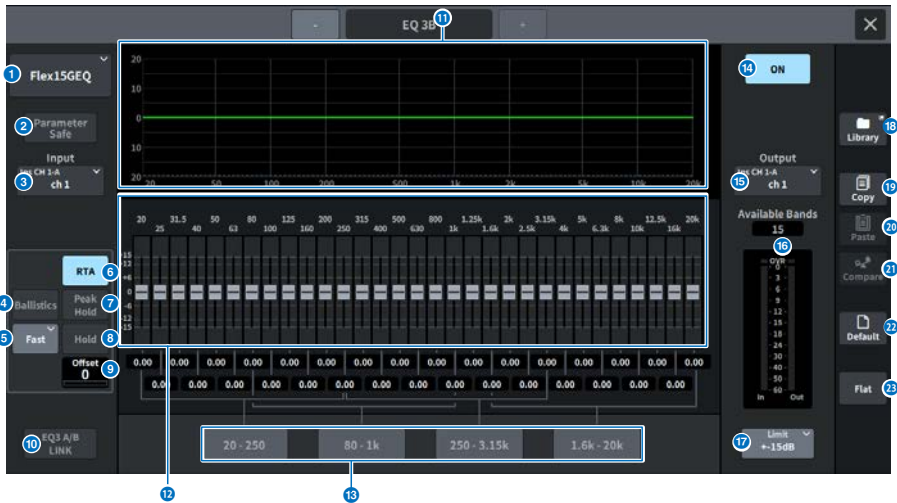

The screen contains the following items.

1 EQ select buttons

Allows you to select the EQ that will be mounted.

2 Parameter Safe button

Switches Recall Safe for parameters on/off.

3 Input button

Press this to display a screen to select the channels to be patched to this rack.

4 BALLISTICS button

If this button is on, you will be able to add attenuation rate to the analyzed frequency response graph.

5 FAST/SLOW toggle button

Switches the attenuation rate (FAST/SLOW).

6 RTA button

If this button is on, a semi-opaque frequency response graph of the input signal (immediately after EQ) will be superimposed on top of the EQ frequency response graph.

7 PEAK HOLD

If this button is on, the analyzed frequency response graph will hold the peak level indication.

8 HOLD button

When this button is on, the frequency response graph will display and hold the result of the frequency analysis.

9 Offset

Sets the offset for the RTA display.

10 EQ A/B LINK button

Press this button to display the GEQ LINK screen where you can link the GEQ of paired channels.

11 EQ graph

Displays the current approximate characteristics of the 31BandGEQ/15BandGEQ.

12 Fader

This is the fader that displays the amount of boost/cut for each band of the 31BandGEQ/15BandGEQ. The actual values can be checked in the numerical boxes below. The fader selected for operation on the touchscreen can be operated with the [TOUCH AND TURN] knob.

13 FADER ASSIGN field

This is the field to select the group of bands that will be controlled by the faders in the channel strip section.

14 EQ ON button

Switches the currently-selected EQ on/off.

15 Output button

Press this to display a screen to select the channels to be patched to this rack.

16 Level meter

Displays the peak level of signals before and after the EQ. For a stereo channel, these meters indicate the level of both the L and R channels.

17 LIMIT select button

Allows you to select the range of gain adjustment from the following options: ± 15 dB, ± 12 dB, ± 6 dB (these are valid in both the boost and cut directions), or -24 dB (valid only in the cut direction).

18 LIBRARY button

Press this to open the EQ library screen.

19 COPY button

Copies the selected GEQ settings to buffer memory.

20 PASTE button

Press this to paste the settings that were copied in buffer memory to the current GEQ. If valid data has not been copied into buffer memory, pasting is not possible.

21 COMPARE button

Press this to switch between the current GEQ settings and the data in buffer memory. If valid data has not been copied into buffer memory, you will not be able to compare the data.

Screens > RACK Screen

22 **DEFAULT button**

Press this to restore the default parameter setting.

23 **FLAT button**

Press this to reset the GAIN parameters of all GEQ bands to 0 dB.

PEQ Edit screen



The screen contains the following items.

- 1 **EQ select buttons**
Allows you to select the EQ that will be mounted.
- 2 **Parameter Safe button**
Switches Recall Safe for parameters on/off.
- 3 **Input button**
Press this to display a screen to select the channels to be patched to this rack.
- 4 **BALLISTICS button**
If this button is on, you will be able to add attenuation rate to the analyzed frequency response graph.
- 5 **FAST/SLOW toggle button**
Switches the attenuation rate (FAST/SLOW).
- 6 **RTA button**
If this button is on, a semi-opaque frequency response graph of the input signal (immediately after EQ) will be superimposed on top of the EQ frequency response graph.
- 7 **PEAK HOLD**
If this button is on, the analyzed frequency response graph will hold the peak level indication.
- 8 **HOLD button**
When this button is on, the frequency response graph will display and hold the result of the frequency analysis.

9 Offset

Sets the offset for the RTA display.

10 EQ A/B LINK button

Press this button to display the PEQ LINK screen where you can link the PEQ of paired channels.

11 EQ type select button

Switches the EQ type to PRECISE, AGGRESSIVE, SMOOTH, or LEGACY.

12 PEQ graph

Displays the parameter values for the PEQ and filters.

13 ATT

Adjusts the level.

14 Parameter select button

Allows you to select parameters to be set.

15 EQ parameter

The parameters for each band and filter of the selected bands (BAND1 to BAND8) are displayed. When the screen is pressed to select, the value can be adjusted by sliding vertically or horizontally or using the [TOUCH AND TURN] knob.

16 EQ ON button

Switches the currently-selected EQ on/off.

17 Output button

Press this to display a screen to select the channels to be patched to this rack.

18 Level meter

Displays the peak level of signals before and after the EQ. For a stereo channel, these meters indicate the level of both the L and R channels.

19 LIBRARY button

Press this to open the EQ library screen.

20 COPY button

Copies the selected PEQ settings to buffer memory.

21 PASTE button

Press this to paste the settings that were copied in buffer memory to the current PEQ. If valid data has not been copied into buffer memory, pasting is not possible.

22 COMPARE button

Press this to switch between the current PEQ settings and the data in buffer memory. If valid data has not been copied into buffer memory, you will not be able to compare the data.

Screens > RACK Screen

23 **DEFAULT button**

Press this to restore the default parameter setting.

24 **FLAT button**

Press this to reset the GAIN parameters of all PEQ bands to 0 dB.

FX screen

The popup window for each plug-in contains the following items.

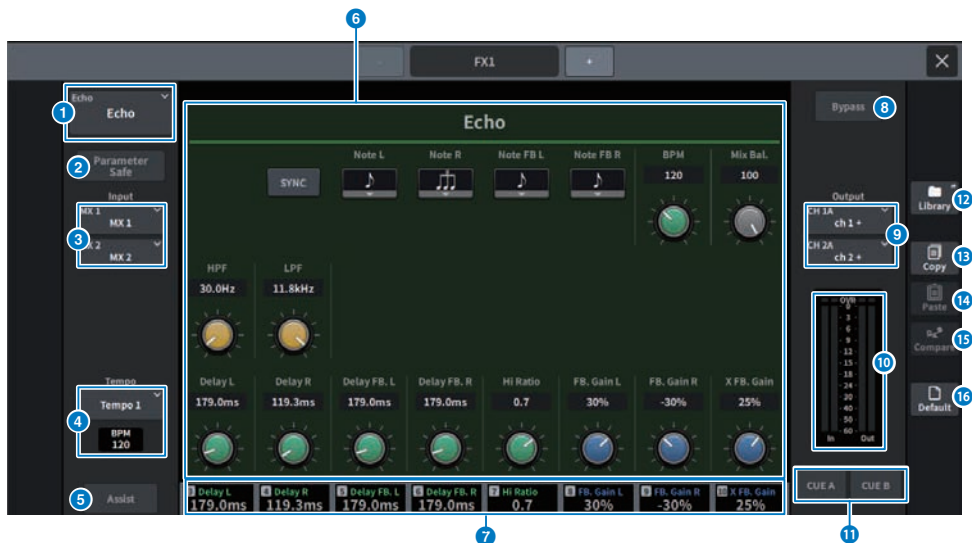

1 MOUNT button

Press this to display the MOUNT screen to select the FX to be mounted.

2 Parameter Safe button

Switches Recall Safe on/off for the FX parameters.

3 Input button (L/R)

Press this to display a screen to select the channels to be patched to this rack.

4 Tempo button

Allows you to select the tempo of the tap tempo function. This is displayed if a delay-type or modulation-type effect is selected.

BMP

Sets the BPM for the selected tap tempo.

5 Assist button

When this is pressed, the screen shows the parameter assignments that can be operated by the screen encoders.

NOTE

If the Assist button is on, you will be able to easily identify the parameters that are currently available for editing, and the parameters that will be available for editing after you select them. By pressing and turning the screen encoder, you can manipulate the parameters in fine increments.

6 Parameter field

The parameters are displayed according to the currently selected FX.

7 Screen encoder access field

Displays the parameter names and parameter values assigned to the screen encoder. To switch the parameter to be operated, press the screen.

8 Bypass button

Sets the plug-in to the bypass status.

9 Output button (L/R)

Press this to display a screen to select the channels to be patched to this rack.

10 IN/OUT meters

Displays the level of the signal before and after it passes through the FX.

11 CUE A/B buttons

When on, the signal after passing through FX can be auditioned. You can choose CUE A, or CUE B.

12 Library button

Press this to open the library screen.

13 Copy button

Copies the selected FX settings to buffer memory.

14 Paste button

Press this button to paste the settings that were copied in buffer memory to the current FX. If valid data has not been copied into buffer memory, pasting is not possible.

15 Compare button

Press this to switch between the current FX settings and the data in buffer memory. If valid data has not been copied into buffer memory, you will not be able to compare the data.

16 Default button

Restores the default parameter settings.

Premium screen

The popup window for each plug-in contains the following items.

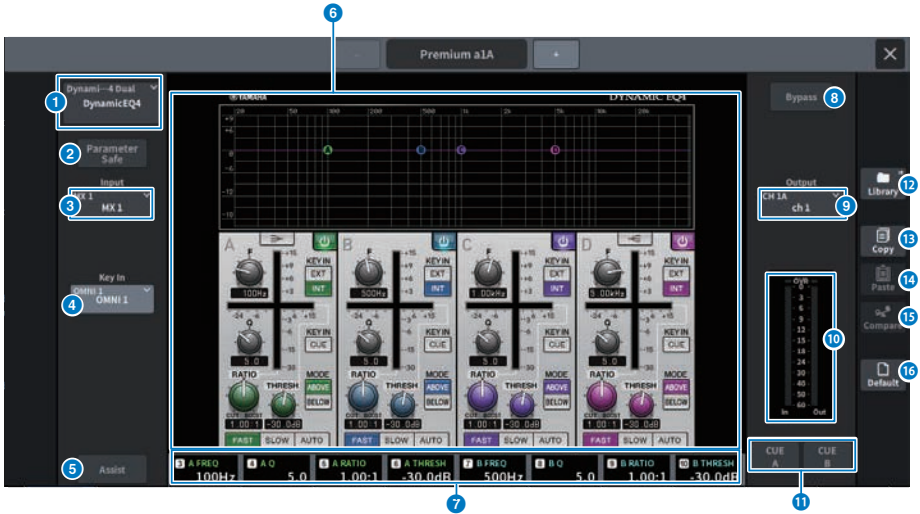

- 1 MOUNT button**
Press this to display the MOUNT screen to select the Premium to be mounted.
- 2 Parameter Safe button**
Switches Recall Safe on/off for Premium parameters.
- 3 Input button**
Press this to display a screen to select the channels to be patched to this rack.
- 4 Key In button**
Press this button to open the Key In Source Select screen where you can select a key-in signal source.



Tempo button

Allows you to select the tempo of the tap tempo function. This is displayed if a delay-type or modulation-type effect is selected.

BMP

Sets the BPM for the selected tap tempo.

- 5 **Assist button**
When this is pressed, the screen shows the parameter assignments that can be operated by the screen encoders.

NOTE

If the Assist button is on, you will be able to easily identify the parameters that are currently available for editing, and the parameters that will be available for editing after you select them. By pressing and turning the screen encoder, you can manipulate the parameters in fine increments.

- 6 **Parameter field**
Displays the parameters of the currently-selected Premium.

- 7 **Screen encoder access field**
Displays the parameter names and parameter values assigned to the screen encoder. To switch the parameter to be operated, press the screen.

- 8 **Bypass button**
Sets the plug-in to the bypass status.

- 9 **Output button**
Press this to display a screen to select the channels to be patched to this rack.

- 10 **IN/OUT meters**
Displays the signal level before and after it passes through Premium.

- 11 **CUE A/B buttons**
When this is on, you can audition the signal after it has passed through Premium. You can choose CUE A, or CUE B.

- 12 **Library button**
Press this to open the library screen.

- 13 **Copy button**
Copies the settings of the selected Premium in to buffer memory.

- 14 **Paste button**
Press this to paste the settings that were copied in to the buffer memory to the current Premium. If valid data has not been copied into buffer memory, pasting is not possible.

15

Compare button

Press this button to switch between the current Premium settings and the data in buffer memory. If valid data has not been copied into buffer memory, you will not be able to compare the data.

16

Default button

Restores the default parameter settings.

CH PARAMETER Screen

1ch Gain screen

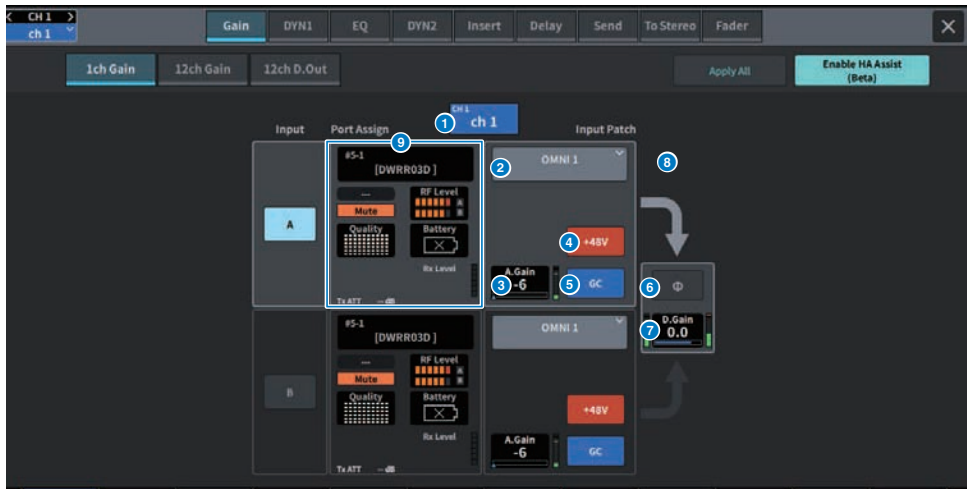

The screen contains the following items.

1 Channel display

The name and color of the current channel are displayed in the button.

2 Patch information

Displays the channel's patch status.

A. Gain

3 This displays the HA analog gain setting value. When the screen is pressed to select, the value is adjusted by sliding vertically or horizontally or using the [TOUCH AND TURN] knob. If gain compensation is on, an indicator is displayed showing the analog gain position at the time that gain compensation was turned on.

4 +48V button

Switches phantom power (+48V) on/off.

5 GC (GAIN COMPENSATION) button

Switches the gain compensation on/off for each channel.

6 Phase button

Switches the phase of the input signal.

D. Gain

- 7 Displays the digital gain setting. When the screen is pressed to select, the value is adjusted by sliding vertically or horizontally or using the [TOUCH AND TURN] knob.

GANG button

- 8 This is display only for stereo. If this button is on, the differences in LR analog gain will be maintained and linked. The same applies to digital gain.

PortAssign

- 9 Displays the information assigned to a port. For details, refer to the I/O DEVICE Wireless screen.

12ch Gain screen

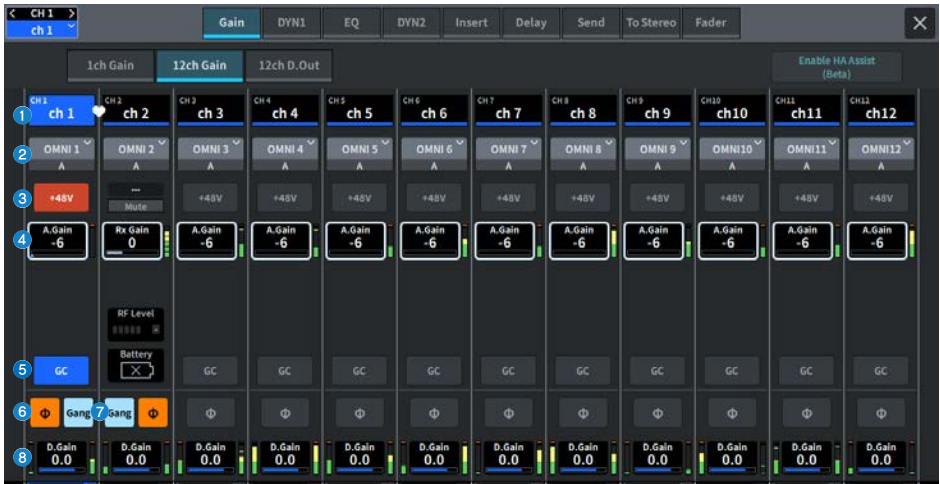

The screen contains the following items.

Channel select button

- 1 Displays the channels. Press this button to select the channel. The name and color of the current channel are displayed in the button.

Patch information

- 2 Displays the channel's patch status.

+48V button

- 3 Switches phantom power (+48V) on/off.

A. Gain

- 4 This displays the HA analog gain setting value. When the screen is pressed to select, the value is adjusted by sliding vertically or horizontally or using the [TOUCH AND TURN] knob. If gain compensation is on, an indicator is displayed showing the analog gain position at the time that gain compensation was turned on.

GC (GAIN COMPENSATION) button

- 5 Switches the gain compensation on/off for each channel.

Phase button

- 6 Switches the phase of the input signal.

GANG button

- 7 This is display only for stereo. If this button is on, the differences in LR analog gain will be maintained and linked. The same applies to digital gain.

D. Gain

- 8 Displays the digital gain setting. When the screen is pressed to select, the value is adjusted by sliding vertically or horizontally or using the [TOUCH AND TURN] knob.

12ch D.Out screen



The screen contains the following items.

1 Channel select button

2 DIRECT OUT ON button

Switches direct out on/off. The currently set direct out point is displayed at the bottom of the button.

3 DIRECT OUT PATCH popup button

Displays the currently-selected port. If nothing is selected, the button displays "----". Press this button to display the patch screen.

4 DIRECT OUT point

Allows you to select the signal extraction point as Pre Filter, Pre DYN1, Pre Proc, Mid Proc, Pre Fader, Post Fader and Post On.

5 FOLLOW setting buttons

Allows you to set parameters for signals routed from input channels to the direct out so that the parameters will follow the FADER/ON/DCA settings.

6 DIRECT OUT LEVEL

Displays the output level of the Direct Out. When the screen is pressed to select, the level can be adjusted by sliding vertically or horizontally or using the [TOUCH AND TURN] knob.

Insert screen

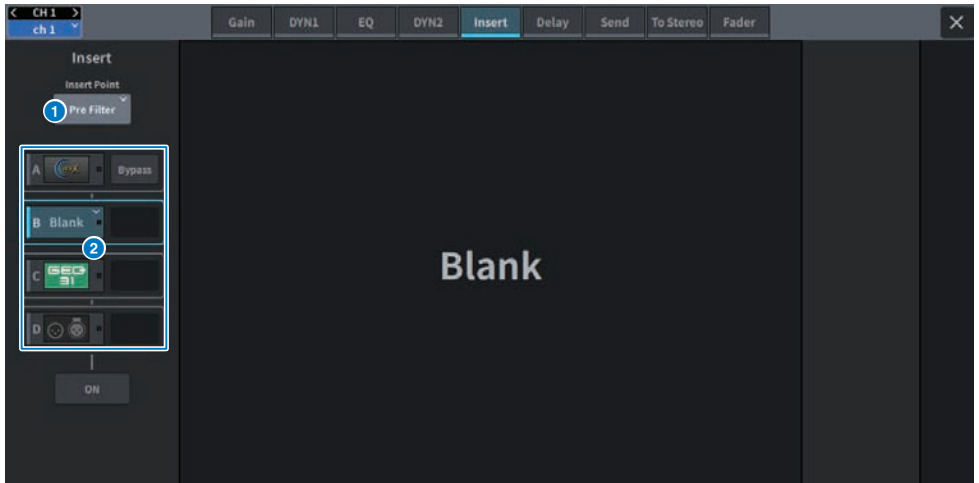

The screen contains the following items.

- 1 Insert Point**
Allows you to select the insert location from Pre Filter, Pre DYN1, Pre Fader and Post ON.
- 2 Insert block [A]-Insert block [D] buttons**
Displays four plug-ins that have been assigned to each Insert. Press this button to display the edit screen for the assigned plug-in. Press again to display the effect patch setting screen.

Delay screen



The screen contains the following items.

1 DELAY SCALE popup window

Press this to display the DELAY SCALE popup window where you can set the unit for the delay time.

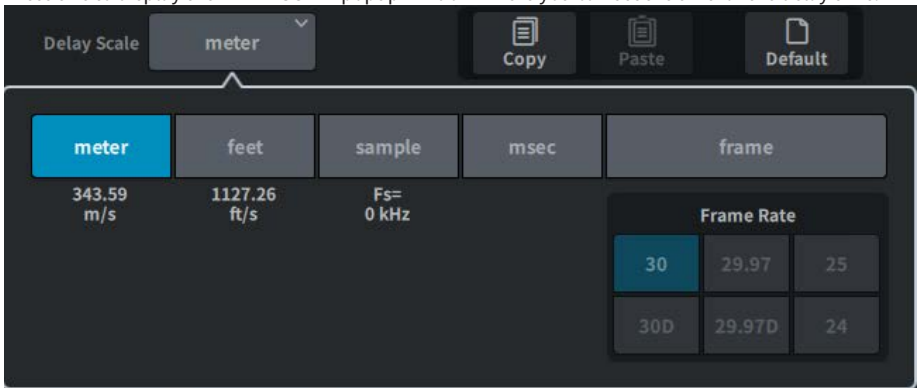

2 Channel select button

Each button will light to indicate that the corresponding channel is selected. Press to select that channel.

3 DELAY ON buttons

Switches delay on/off.

4 Delay insert point select buttons

Allows you to select the delay insert point from the following: Pre Filter, Pre DYN1, Pre Fader and Post Fader

5 Gang button

This button is displayed when channels are paired. If this is on, the difference between the delay time values are maintained and linked.

6 Delay setting

Displays the channel delay value. When the screen is pressed to select, the value can be changed by sliding vertically or horizontally or using the [TOUCH AND TURN] knob. You can view the current value immediately above the knob (always shown in unit of ms) and below the knob (shown using the currently-selected scale).

NOTE

If msec (millisecond) has been selected for the DELAY SCALE, nothing will appear above the knob.

Send screen

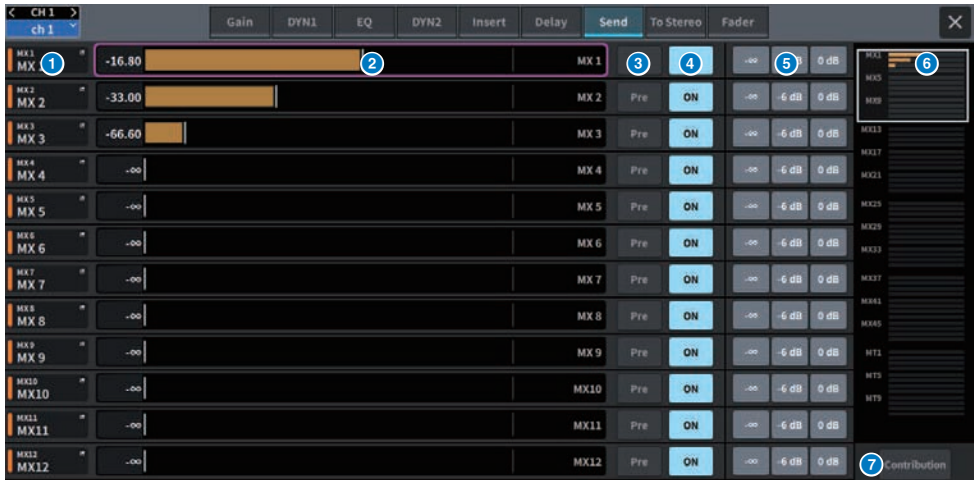

The screen contains the following items.

1 Send destination bus button

Press to display the send destination's Send To screen.

2 SEND channel area

Displays the send level and delay for 12 channels.

When the screen is pressed to select, the send level and pan for the bus can be adjusted by sliding horizontally or using the [TOUCH AND TURN] knob.

3 PRE button

Selects either PRE or POST as the send point of the signal that is sent to each bus. If a button is lit, the send point is set to PRE.

4 SEND ON button

This button switches send to each bus on/off.

5 Preset button

For send level, $-\infty$, -6 dB or 0 dB can be selected.

For pan, L, C or R can be selected.

6 MIX/MATRIX overview

This displays the send level and pan from the channel to the MIX/MATRIX bus. The area currently displayed in detail is indicated by a white border. The area can be changed using tap or slide.

7 Contribution button

Press this to display the busses with send level and pan settings together in the SEND channel area.

OVERVIEW Screen

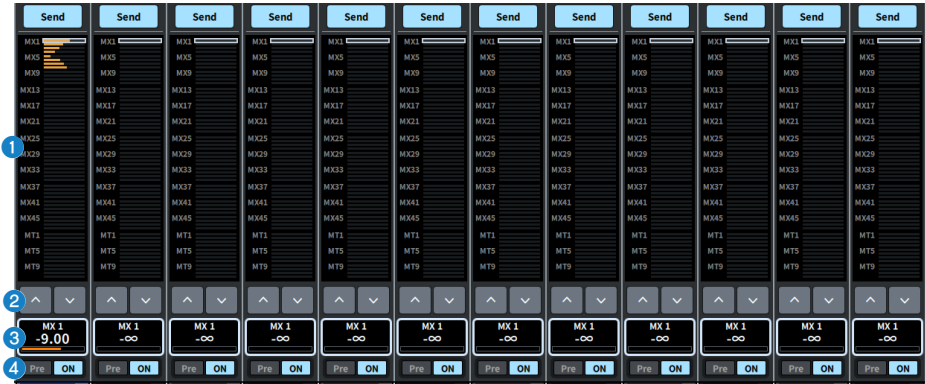

8 MIX/MATRIX overview

This displays the send level and pan from the channel to the MIX/MATRIX bus. The bus currently displayed the level is indicated by a white border. Press and hold to display a screen for selecting the target bus.

9 Select button

You can use this button to select the bus.

10 Level/Pan display

Displays the send level and pan from the selected channel to the MIX and MATRIX buses.

11 PRE button

Selects either PRE or POST as the send point of the signal that is sent to each bus. If a button is lit, the send point is set to PRE.

SEND ON button

This button switches send to each bus on/off.

To Stereo screen

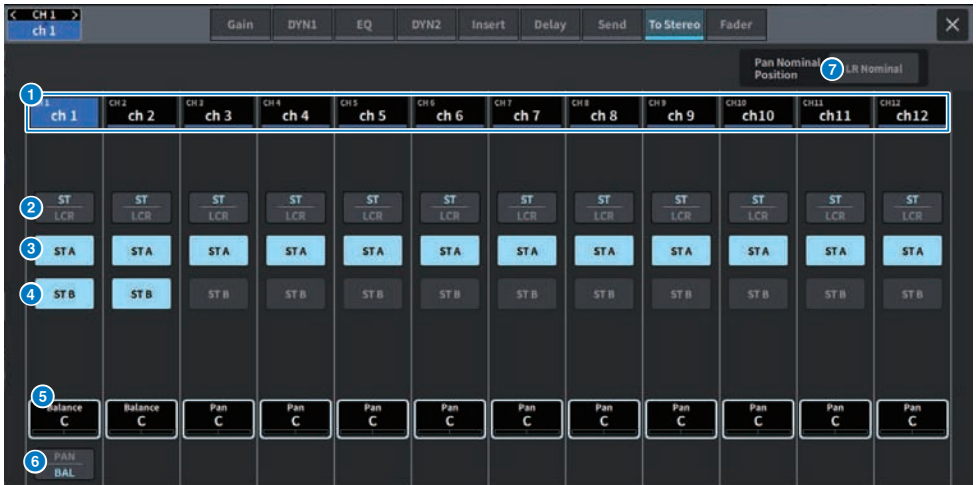

The screen contains the following items.

1 Channel select button

2 ST/LCR mode select button

Press to switch the mode between ST and LCR. The currently selected mode is highlighted

3 TO ST A button

Turns the signal sent to the STEREO A bus on/off.

4 TO ST B button

Turns the signal sent to the STEREO B bus on/off.

5 TO ST PAN/TO ST BALANCE

For a MONO channel, this adjusts the left/right position of the signal sent to the STEREO bus. For a STEREO channel, this adjusts the volume balance of the left/right signals sent to the STEREO bus. When the screen is pressed to select, the value can be changed by sliding vertically or horizontally or using the [TOUCH AND TURN] knob.

For a STEREO channel the following button is displayed.

6 PAN/BALANCE select button

This button selects whether the volume balance (BALANCE) or the pan (PAN) of the signal sent to the STEREO bus will be adjusted.

For a MIX channel, the following pull-down menu is displayed above the ST/LCR mode select button.

TO STEREO send point

Allows you to select the send point as Pre Filter, Pre Proc, Mid Proc, Pre Delay, Pre Fader, Post Fader or Post ON.

7 LR Nominal button

When on, the center of the mono channel is set to -3 dB and the LR sweep is set to 0 dB. The fault is 0 dB for the center of the monaural channel and 3 dB for the LR sweep.

Fader screen

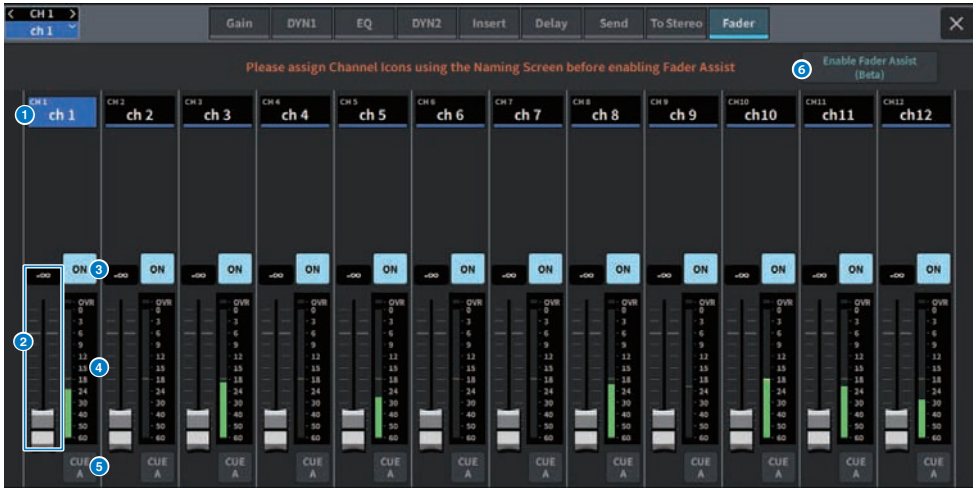

The screen contains the following items.

- 1 **Channel select button**
- 2 **Fader**
Adjusts the channel signal level.
- 3 **ON button**
Switches the channel on/off.
- 4 **Meter**
This is the meter that displays the level.
- 5 **CUE**
Switches channel cue on/off.

NAME Screen

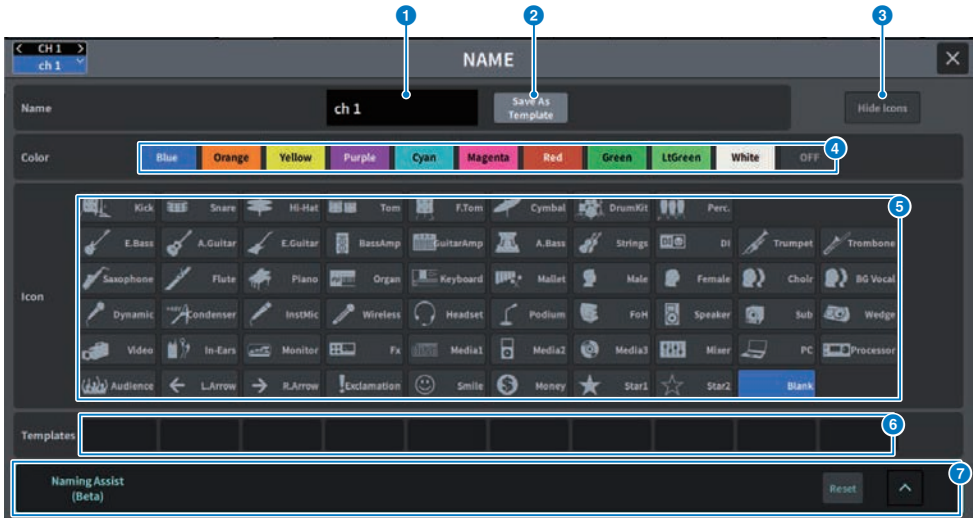

The screen contains the following items.

1 Channel name edit box

Displays the name of the channel that is currently selected. Press this to display the keyboard used to apply names.

Multilingual channel names can be entered via DM7 Editor or DM7 StageMix.

2 Save As Template button

Turn this button on and press a template select button to store as a template.

3 HIDE ICON button

Press this button to hide the icon.

4 Channel color select buttons

Allows you to select a channel color. Press this to apply the change. If you select OFF, the channel color and icon will be grayed out.

5 Icon select buttons

Allows you to select a channel icon. Press this to apply the change.

6 Template select buttons

Allows you to select a template. Press this to apply the change.

7 Naming Assist

This recommends an icon and channel name corresponding to the channel's input signal.

CH LIBRARY Screen

Using libraries allows you to store and recall the EQ or Dynamics settings of the currently-selected channel.

The screenshot shows the 'INPUT CH LIBRARY' interface. At the top, there is a 'List Filter' section with a 'Show All' button, two category dropdown menus (both set to 'None'), and three filter buttons: 'All', 'EQ', and 'DYN'. Below this is a table with columns: No., Title, Type, Category 1, Category 2, and Focus. The first row is highlighted in blue and contains the following data: No. 001, Title 'Initial Data', Type 'MONO (1=480)', Category 1 'Choir', Category 2, and Focus 'All EQ DYN DYN'. To the right of the table are buttons for 'Clear', 'Store', and 'Recall'. At the bottom right, a 'Total Library Usage' indicator shows '1 / 600 Used'. A blue box highlights the 'List Filter' section, and a blue circle with the number '1' is placed above the 'List Filter' label. Another blue circle with the number '2' is placed in the empty row 005 of the table.

No.	Title	Type	Category 1	Category 2	Focus
001	Initial Data	MONO (1=480)	Choir		All EQ DYN DYN
002					
003					
004					
005					
006					
007					
008					
009					
010					
011					

1 List Filter

Selectively displays the data from the list.

The differentiating elements are Category1, Category2, and Focus.

2 List

Displays the setting data (presets) stored in the library. Colored columns indicate that they have been selected for operation.

- **Title:** Title
- **Type:** Information on setting data (STEREO/MONO, output channel type, etc.)
- **Category1:** Channel icon contents



- **Category2:** User-defined
Input via the keyboard screen.
- **Focus:** Recalled data
All: All data
EQ, DYN1, DYN2: EQ and dynamics data

3 Clear button

Clears the setting data of the selected target.

4 Store button

Stores EQ, dynamics, and other settings for the currently selected channel.

5 Recall button

Recalls the setting data of the selected item.

6 Total Library Usage

Up to 600 user presets can be stored in all libraries collectively.

ACTOR Screen (Theater Package Compatible)



This screen contains the following items.

- 1 **Input Ch**
Displays the input channel to which the actor library is assigned.
- 2 **Actor Mode**
When on, the channel will be set to the actor mode.
- 3 **Actor Library**
Displays the set actor library name. Press to display the ACTOR LIBRARY Screen for setting the actor library.
- 4 **Apply button**
Updates the library with current data.
- 5 **Revert button**
Recalls the library set for that channel. Any changes made to the current data will be overwritten in the recalled library.
- 6 **Default button**
Clears the library settings and initializes the current EQ and dynamics 4-bank data.
- 7 **INPUT NAME selection**
Operated with either the screen encoder or the [TOUCH AND TURN] knob.
- 8 **All Actor**
When on, all channels will be set to the actor mode.

9 Apply Edited button

Updates the library of all changed channels.

10 Revert Edited button

Recalls the library of all changed channels.

11 Default All button

Clears the library settings of all channels and initializes the current EQ and dynamics 4-bank data.

SURROUND Screen (Broadcast Package Compatible)

SURROUND SETUP screen

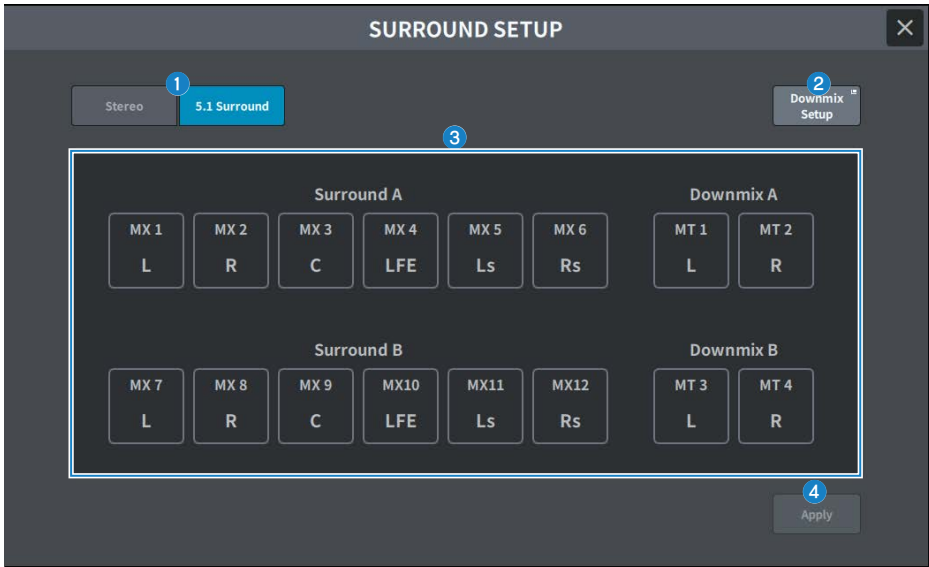

- 1 Mixing mode select buttons**
Switches between Stereo mode and 5.1 Surround mode.
- 2 Downmix Setup buttons**
Press to open the DOWNMIX SETUP screen.
- 3 Surround bus setting display**
Displays the Surround bus settings.
 - Use Surround A MX 1-6
 - Use Surround B MX 7-12
 - Use Downmix A MT 1-2
 - Use Downmix B MT 3-4
- 4 Apply button**
Press to switch to the selected mode.

DOWNMIX SETUP screen



1 Downmix Settings

Sets the downmix coefficients for Surround A, Surround B and Monitor.

- **Assignment buttons (L, R)**

Turns the assignment to Downmix L, R on/off.

- **Level**

Sets the send amount to Downmix L, R.

2 Apply to Monitor buttons

Applies the corresponding downmix settings to the Monitor downmix settings.

Channel Parameter screen (Surround Pan tab)



1 Page Switching buttons

Switch between 1-channel display and 72-channel display.

2 Surround Pan Image

Displays the position (Left-Right, Front-Rear) as a ball on an XY graph.

3 Assign buttons(L, C, R, Ls, LFE, Rs)

Turns the send to each surround channel on/off.

4 Surround Assign buttons (A, B)

Turns the send to the surround bus on/off.

5 Surround pan parameters

- **LR**
Sets panning in the Left-Right direction
- **FR**
Sets panning in the Front-Rear direction
- **Div**
Sets the concentration on the Center channel
- **LFE**
Sets the send amount to the Low Frequency Effect channel

These pan parameters are assigned to Screen Encoders 2 to 5 (8 to 11 for the R side).

6 Copy button

Press to copy the surround pan parameters.

- Parameters to be copied
 - Surround pan parameter
 - Assign buttons (L, C, R, Ls, LFE, Rs)
 - Surround assign buttons (A, B)

7 Paste button

Press to paste the copied surround pan parameters.

8 Compare button

Press to compare with the copied surround pan parameters.

9 Default button

Press to call up a confirmation message for whether to return to the initial values or not.

Channel Parameter screen (Surround Pan tab)



Thumbnail display

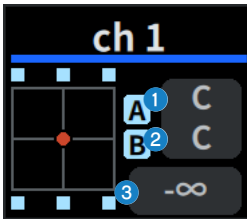

- 1 LR value display
- 2 FR value display
- 3 LFE value display

Displays the surround pan position for each channel and the assignment to the surround bus.

Select a channel to adjust the LR (Left, Right) value, FR (Front, Rear) value, and LFE (Low Frequency Effect) value. Slide to select multiple channels.

When the display area is pressed and a white frame appears, it can be operated with the screen encoder.

Press the LR/FR value display to adjust LR or FR, and press the LFE value display to adjust LFE.

MONITOR (MONITOR) screen (Surround)

Operates the signals to be checked on headphones or external monitor speakers when in Surround mode.

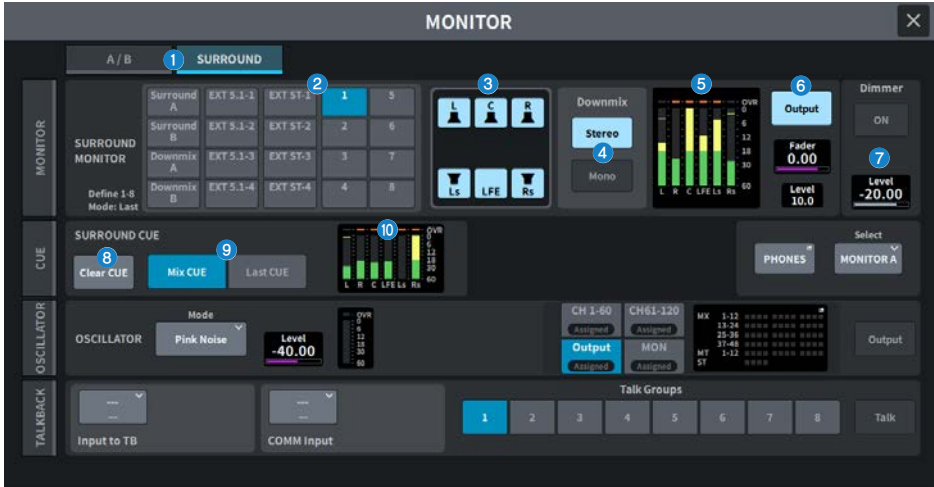

1 Page Switching Tabs

Switches the page to be displayed.

- **A/B**
Monitor A/B, Cue A/B
- **Surround**
Surround Monitor, Surround Cue

2 Source select buttons

For selecting the source for the Surround Monitor.

- **Surround A**
Surround A bus
- **Surround B**
Surround B bus
- **Downmix A**
Downmix A bus
- **Downmix B**
Downmix B bus
- **EXT 5.1-1 - EXT 5.1-4**
Surround external inputs 1-4
- **EXT ST-1 - EXT ST-4**
Stereo external inputs 1-4
- **1-8**
Monitor source definition 1-8 (Shared with Monitor A/B)

3 Speaker mute buttons

Press to turn the corresponding speaker on/off.

If speaker mute is in Solo mode, it will operate as a solo speaker.

4 Downmix buttons

- **Stereo button**
Turn on to output a stereo downmix.
- **Mono button**
Turn on to output a mono downmix.

5 Level meter

Displays the source level.

6 Output

- **Output button**
Turns the Surround Monitor output on/off.
- **Level**
Adjusts the output level of Surround Monitor.
DM7 Control
When not connected: Adjustment is possible by touch and turn.
When connected: No display.
- **Fader**
Adjusts the output fader of Surround Monitor.

7 Dimmer

ON button Turns the Surround Monitor dimmer on/off.

Level Adjusts the Surround Monitor dimmer level.

8 Clear CUE button

Touch to clear the Surround CUE.

9 Cue Mode select buttons

Selects the Surround Cue mode.

Mix CUE Mix CUE mode

Last CUE Last CUE mode

10 Level meter

Displays the Surround Cue level.

MONITOR(MONITOR) screen

Operates the signal to be checked through headphones or external monitor speakers.



1 Source select buttons

For selecting the source for the Surround Monitor.

- **Surround A**
Surround A bus
- **Surround B**
Surround B bus
- **Downmix A**
Downmix A bus
- **Downmix B**
Downmix B bus
- **EXT 5.1-1 - EXT 5.1-4**
Surround external inputs 1-4
- **EXT ST-1 - EXT ST-4**
Stereo external inputs 1-4
- **1-8**
Monitor source definition 1-8 (Shared with Monitor A/B)

2 Setup button (EXT)

Press to open the MONITOR SOURCE EXT DEFINE window.

3 Mode select button (Define)

Selects the selection mode for monitor source definitions 1-8 .

- **Last**

Selects only the last selected source

- **Mix**

Selects multiple monitor sources (up to a total of 8 channels).

4 Setup button (Define)

Touch to open the MONITOR SOURCE DEFINE window.

5 Downmix buttons

- **Stereo button**

Turn on to output a stereo downmix.

- **Mono button**

Turn on to output a mono downmix.

- **Setup button**

Touch to open the DOWNMIX SETUP window.

6 Level meter

Displays the source level.

7 Speaker mute buttons

Touch to turn the corresponding speaker on/off.

If Speaker Mute is in Solo mode:

SOLO button

Turns Speaker Mute SOLO mode on/off.

8 Output button

Turns Surround Monitor output on/off.

9 Output Patch button

Touch to open the Output Patch setting screen.

10 Fader

Adjusts the output fader for Surround Monitor.

11 Level

Adjusts the output level of Surround Monitor.

When the DM7 Control is not connected: Adjusts the output level with the [TOUCH AND TURN] knob.

When the DM7 Control is connected: The display disappears and the output level is adjusted with the DM7 Control.

12 Phones Level Link button

When set to ON, this adjusts the level of the signal sent to the PHONES output terminal to the Surround This can be linked to the level of the Monitor output fader and operated.

13 CUE Interrupt button

This button interrupts the monitor signal. When this button is on and cue is enabled, the cue signal will be sent to the monitor output.

14 Dimmer on CUE

- **CUE indicators**

When CUE is active, CUE A and CUE B light up respectively.

- **Dimmer level**

Adjusts the attenuation of the monitor signal when CUE is turned on.

15 Dimmer

- **Dimmer level**

Adjusts the attenuation of the monitor signal when the dimmer is on.

- **ON button**

When this is set to ON, the dimmer is on and the monitor signal is attenuated.

16 Dimmer on TB

- **TB indicator**

Displays the on/off status of the dimmer function for talkback.

- **Dimmer Level**

Adjusts the attenuation of the monitor signal when talkback is turned on.

17 COMM

- **COMM Level:** Adjusts the level of the COMM signal.

- **ON button:** When this is set to ON, the COMM signal is enabled.

18 COMM Interrupt button

This button adds the COMM signal to the monitor signal. When this button is on, the COMM signal is sent to the monitor output.

MONITOR SOURCE EXT DEFINE screen

Sets the monitor input source.

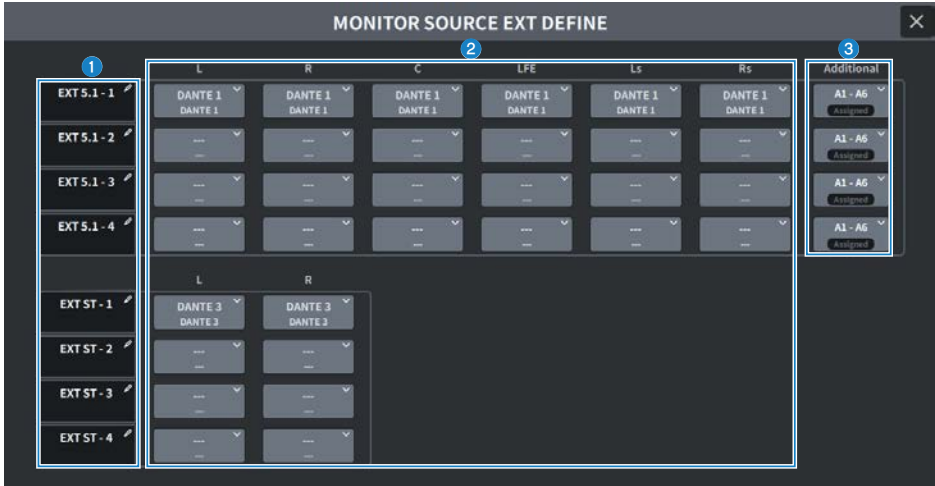

1 Source label display

Displays the source label. Press to display a keyboard for editing the label.

2 Source display

Displays the input source of the external surround source (5.1 ch).

3 Source display (Additional)

Sets up to 6 channels of additional sources for external surround sources in formats exceeding 5.1ch, such as 7.1.4 ch.

SURROUND CUE screen

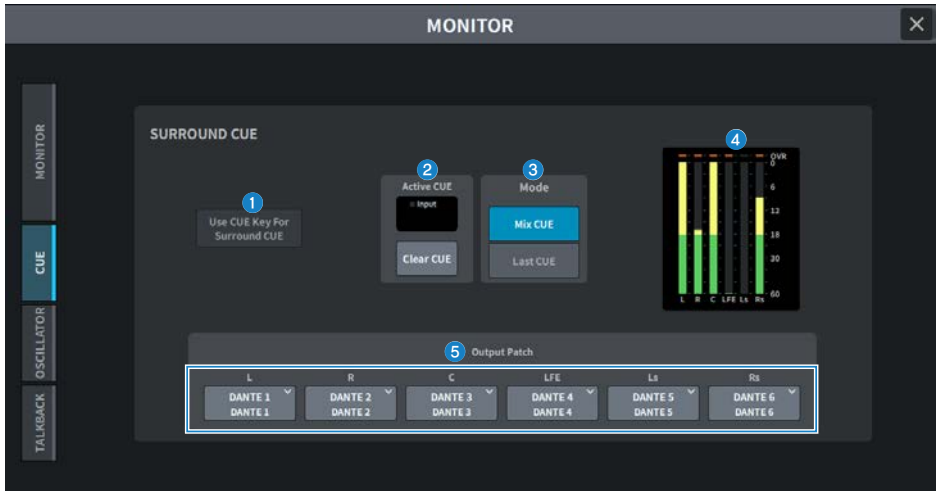

This screen contains the following items.

1 Use CUE Key For Surround CUE button

When this is set to ON, you can use the [CUE] key to turn Surround CUE for the input channel on/off.

2 Active CUE display

When Surround CUE for the input channel is active, the indicator lights (green).

Clear CUE button

Press to clear the cue.

3 Cue Mode select buttons

Selects the Surround Cue mode.

- **Mix CUE**

Mix CUE mode

- **Last CUE**

Last CUE mode

4 Level meter

Displays the Surround Cue level.

5 Output Patch

Displays the output patch for Surround Cue.

PHONES screen

Make settings related to the signals monitored through headphones.

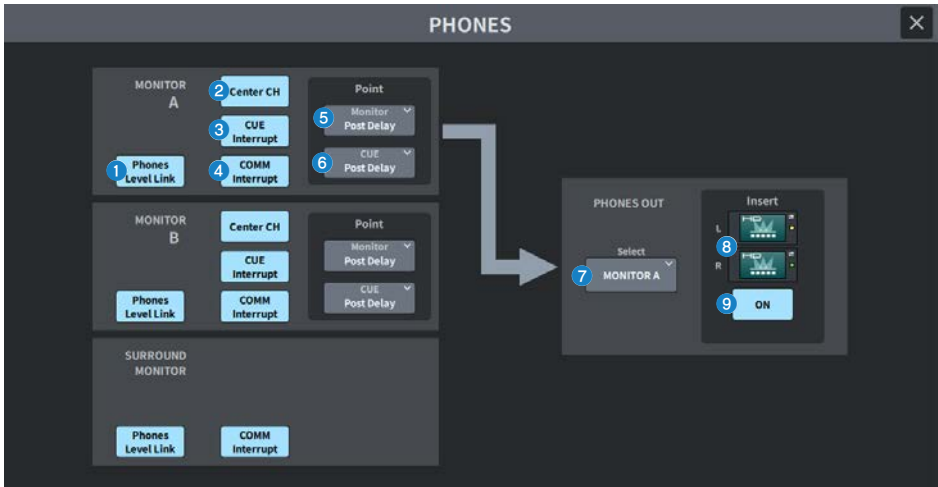

1 Phones Level Link button

When turned on, the level of the signal sent to the PHONES output terminal can be linked to the monitor fader level.

2 CENTER CH ON button

Turn off if you do not want to monitor the center channel.

3 CUE Interrupt button

Turns CUE Interrupt on/off.

NOTE

When CUE is selected as the monitor source, we recommend turning CUE Interrupt off to prevent the monitor source from being cut off by CUE operations.

4 COMM Interrupt button

Turns COMM Interrupt on/off.

5 Point Monitor button

Select the point from which to extract the monitor signal from the following:

- Pre Delay
- Post Delay

6 CUE Monitor button

Selects the point from which the cue signal is extracted from the following.

- Pre Delay
- Post Delay

7 Select button

Selects the signal to be monitored with headphones.

8 Insert button

Press to display a screen for inserting a plug-in into the signal to be monitored with headphones.

9 SURROUND MONITOR (Surround mode only)

- Phones Level Link button
Sets whether to link the Phones Level with the Surround Monitor Level and Surround Monitor Fader.
- COMM Interrupt button
Sets whether to mix the COMM Input into Phones.

UTILITY Screen

Utility Screen

On this screen, you can view the status of the DM7 Series unit, and recall other screens for monitoring or other operational purposes.

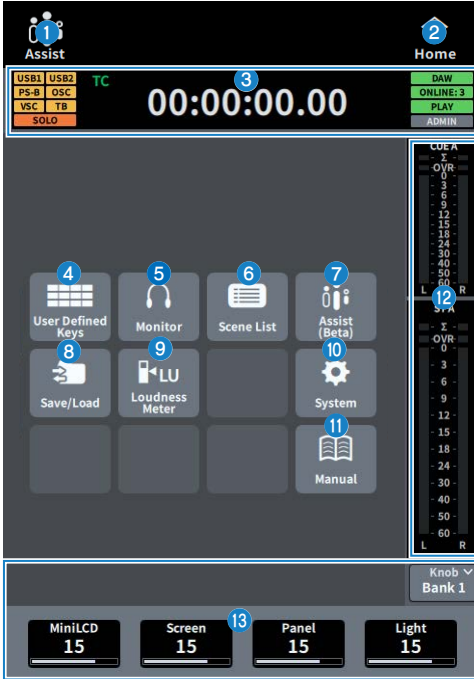

1 Assist display

This icon operates when “Using the Assist Function” (p.414) is enabled. Press this to stop operation.

2 HOME button

Press this to return to the select screen.

3 Status display

- **USB1 USB2:** USB access indicator lamps
- **PS-A PS-B:** Power supply A/B status display
- **OSC ALT:**
OSC: Oscillator On
ALT: User Defined Key Alternate Funcion Active
Displayed in the same area, with priority given to ALT
- **VSC:** Virtual Sound CheckOn (flashing)
- **TB:** Talkback On
- **SOLO:** SOLO On

CLOCK display

TC • • • Displays the data input from the TC IN port

Clock • • • Displays the current time

- **DAW:** DAW connection status. Solid when online
- **ONLINE:[n]:** The number of online Editor, StageMix, and DM7 Control units
- **PLAY REC:** Recorder status (Solid green for Play, flashing red for Rec)
- **ADMIN [User Name]:** Name of the currently logged in user

4 Displays the USER DEFINED KEYS screen. (“USER DEFINED KEYS screen” (p.294))

5 Displays the MONITOR screen. (“MONITOR screen” (p.295))

6 Displays the SCENE LIST screen. (“SCENE LIST Screen” (p.296))

7 Displays the ASSIST screen. (“ASSIST Screen” (p.298))

8 Displays the SAVE/LOAD screen. (“SAVE/LOAD screen” (p.299))

9 Displays the LOUDNESS METER screen. (“LOUDNESS METER Screen” (p.303))

10 Displays the SYSTEM screen. (“SYSTEM Screen” (p.306))

11 Displays the MANUAL screen.

12 Meter

13 User Defined Knobs Display

USER DEFINED KEYS screen

The USER DEFINED KEYS screen allows you to assign functions to USER DEFINED keys.

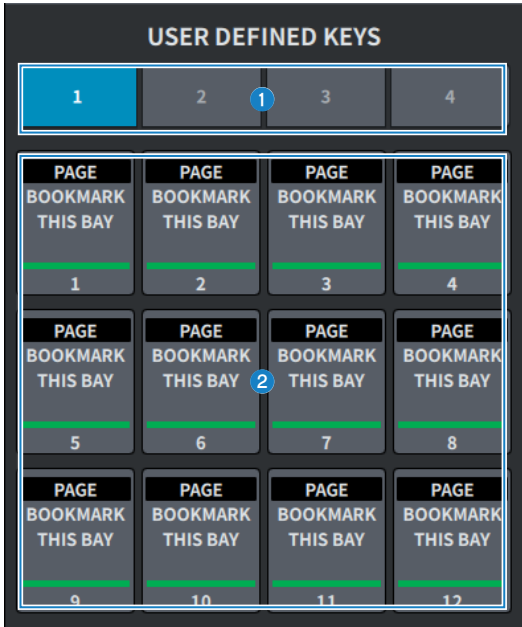

- 1 BANK 1-4 tab**
Switches between the banks for the USER DEFINED keys.
- 2 USER DEFINED KEYS 1-12**
Operates a pre-assigned function.

MONITOR screen

Operates the signal to be checked through headphones or external monitor speakers.

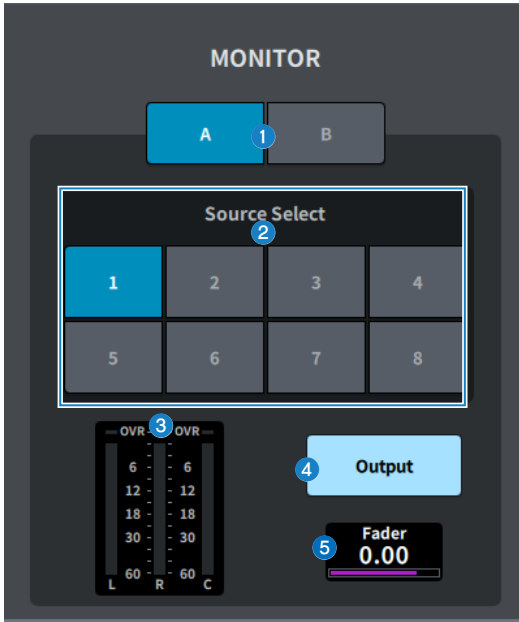

- 1 MONITOR A/MONITOR B button**
Selects the monitor output from the two MONITOR A and MONITOR B systems.
- 2 Source Select button**
Allows you to select one of the DEFINE 1– 8 sources that will be output to the MONITOR bus.
- 3 Meter**
This field displays the output level of the monitor's L/R/C channels.
- 4 MONITOR Output button**
Switches monitor out on/off.
- 5 MONITOR Fader level**
Adjusts the monitor fader level.

SCENE LIST Screen

This screen is used to manage scenes with saved mixer settings.

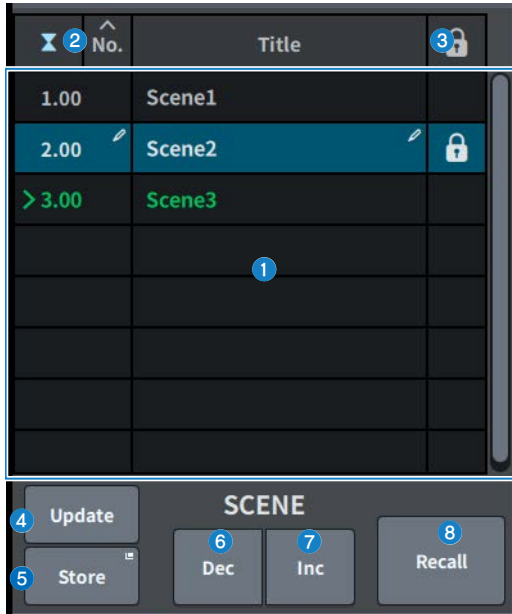

1 Scene list

Displays scenes stored in memory.

Press No. or Title at the top to sort.

The scene highlighted in blue in the list is the currently selected scene.

2 Current scene select button

Press this button to select the scene that was recalled or stored most recently. The current scene is highlighted in green in the list.

3 Protect (lock) symbol

Displays the write protect enabled/disabled status. Press to write-protect the scene, and the button lights up. Press it again to cancel write protection.

4 Update button

Updates scene data by overwriting the scene (that has been recalled or stored most recently) with the current mix data. While the [SHIFT] key is held down, this changes to the Undo Update button.

5 Store button

Creates a new stores for the current mix data. Press to display the SCENE Store screen used to name and save the scene.

6 Dec button

Press this button to move back 1 from the currently-selected scene. While the [SHIFT] key is held down, this changes to the Undo Delete button.

7 Inc button

Press this to move forward 1 from the currently-selected scene. While the [SHIFT] key is held down, this changes to the Delete button.

8 Recall button

Press this button to recall the currently-selected scene. While the [SHIFT] key is held down, this changes to the Undo Recall button.

ASSIST Screen

The ASSIST screen configures the “Using the Assist Function” (p.414) function.

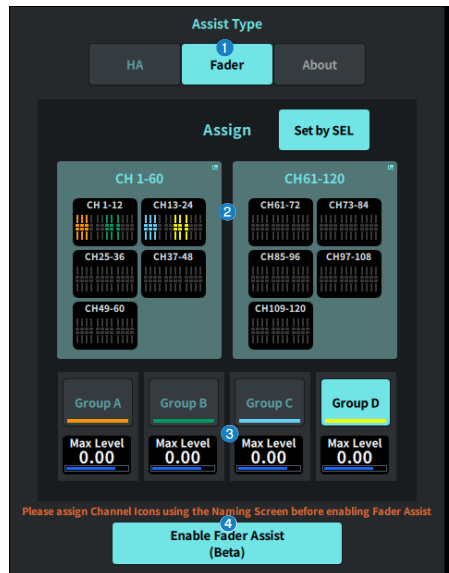

1 Assist Type button

Selects the Assist function.

- HA . . . Configures the HA Assist function.
- Fader . . . Configures the Fader Assist function.

2 Assign field

Selects the channel for which the Assist function is to be configured.

Press the Set by SEL button to select on the panel.

Group A-D can be registered when using the Fader Assist function.

3 User Setup

Configures the user's desired gain and levels in the Assist function.

- HA . . . Set the target HA level and maximum gain in the Assist function.
- Fader . . . Sets the maximum level in the Assist function.

4 Enable HA/Fader Assist button

Enables the Assist function.

SAVE/LOAD screen

The SAVE/LOAD screen displays saved files and subdirectories.

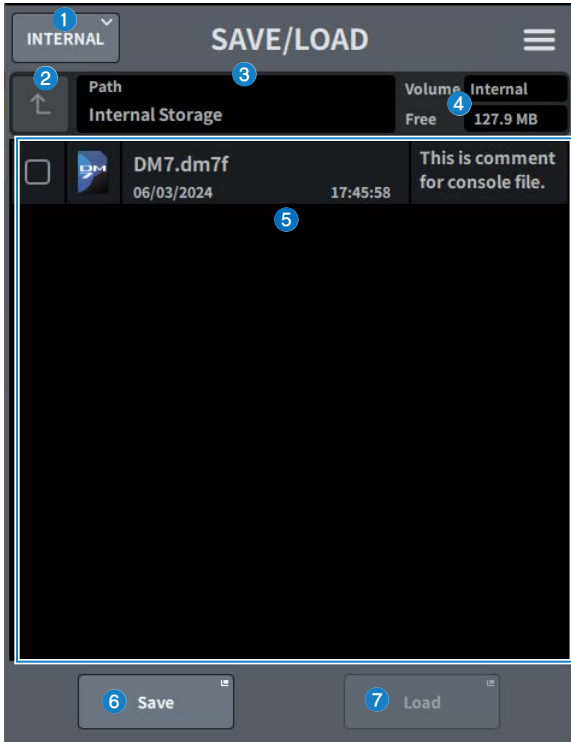

1 USB1/USB2/INTERNAL switch button

Select the desired destination for loading/saving the file.



2 Directory move button

Move the current directory up one level.

If the current directory is the top level, the arrow button is grayed out.

3 Current directory display

Displays the bus of the current directory.

4 Volume name display

Displays the volume name and the amount of free space on the USB drive.

The time required to calculate free space depends on the capacity of the connected USB storage device. When a large USB storage device is connected, it may take more than 3 minutes to calculate the free space.

5 File list

Files and subdirectories stored on the USB storage device are displayed. Colored rows indicate that they have been selected for operation.

6 Save button

Saves the DM7 Series settings.

Press the Save button to display the SAVE screen.

If the configuration file cannot be saved due to insufficient storage capacity, an error message will be displayed.

7 Load button

Loads the selected DM7 Series settings file.

Image files (png, bmp, jpg files) for display on the CONSOLE LOCK screen can also be loaded.

Press the Load button to display the LOAD screen.

After loading the file, a message is displayed when a specific license function is used, even if there is no license.

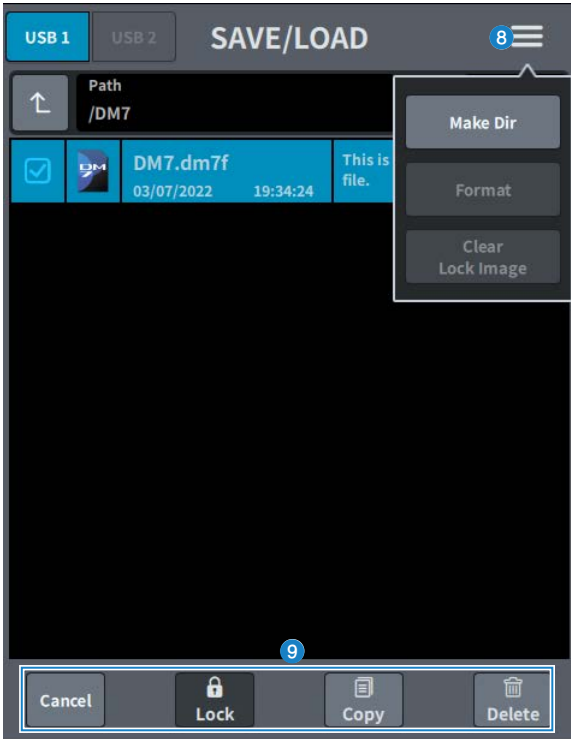

8 Menu button

- **Make Dir:** Creates a new directory.
- **Format:** Formats the USB drive.

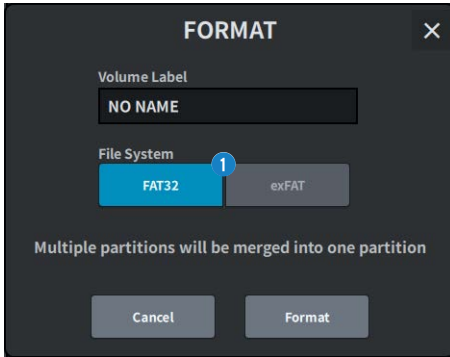

1 File System selection button

Selects the format (FAT32/exFAT).

- **Clear Lock Image:** Deletes the image set for the console lock screen.

9 Tool buttons

Operates on data that has a check mark in the file list.

NOTE

Formats supported by DM7 Series

Format	Maximum volume	File size limit	Compatibility with previous models
FAT32 (MBR partition)	2TB	4GB	Yes
FAT32 (GPT partition)	18EB	4GB	No
exFAT	256TB	No	No

LOUDNESS METER Screen

Broadcast Package compatible. By installing a loudness meter, the loudness level can be displayed on the mixer itself.

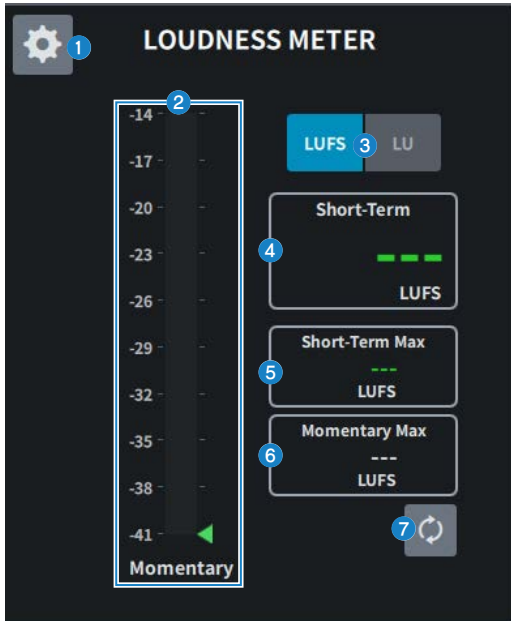

1 Settings icon

Opens the LOUDNESS METER SETUP screen.

2 Loudness meter

Displays the Momentary level.

The short-term level is indicated by triangle on the right side of the meter.

3 LUFS (LKFS)/LU switch button

Switches between absolute value display and relative value display.

4 Short-Term display

Displays the Short-Term value.

5 Short-Term Max display

Displays the maximum Short-Term value.

6 Momentary Max display

Displays the maximum Momentary value.

7 Reset button

Reset the Short-Term Max and Momentary Max values.

LOUDNESS METER SETUP Screen

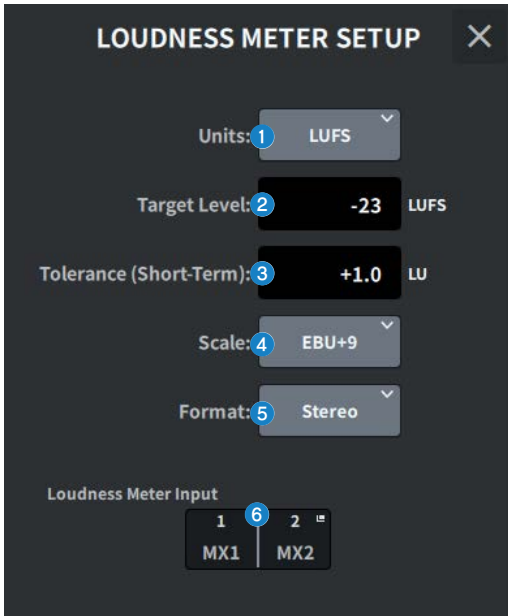

This screen contains the following items.

- 1 Units selection button**
Selects the unit to display when displaying absolute values.
- 2 Target Level setting**
Sets the Target Level.
- 3 Tolerance (Short-Term) setting**
Sets the permissible Short-Term level for the Target Level.
- 4 Scale selection button**
Selects the Loudness Meter scale.
- 5 Format selection button**
Selects the input format for the Loudness Meter.
- 6 Loudness Meter Input display**
Displays the input source of the Loudness Meter. Press to open the LOUDNESS METER INPUT window for selecting the input source.

SYSTEM Screen

The SYSTEM screen displays settings and utilities.

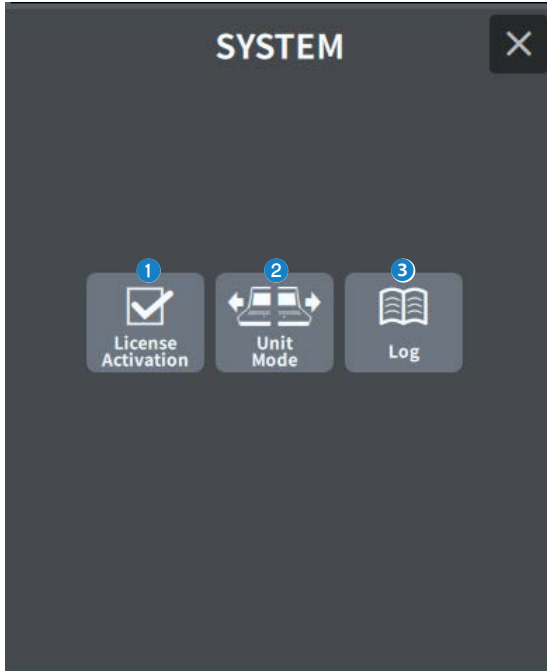

1 License Activation

Press this button to display the LICENSE ACTIVATION screen.

2 Unit Mode

Press this button to display the UNIT MODE screen.

3 Log

Displays the log.

LICENSE ACTIVATION Screen

The License screen displays DEK license information and the QR code used for activation.

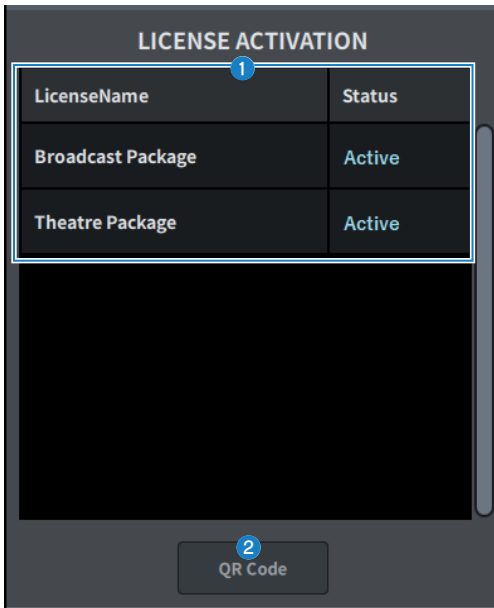

1 License List

Displays license information.

2 QR Code button

Press this to display a QR code.

Use the code during activation. For details, refer to the flyer enclosed with the DEK.

UNIT MODE Screen

The UNIT MODE screen is used to configure the Unit Mode function.

Using “Using Split Mode” (p.418) allows one console to take on two roles at the same time.

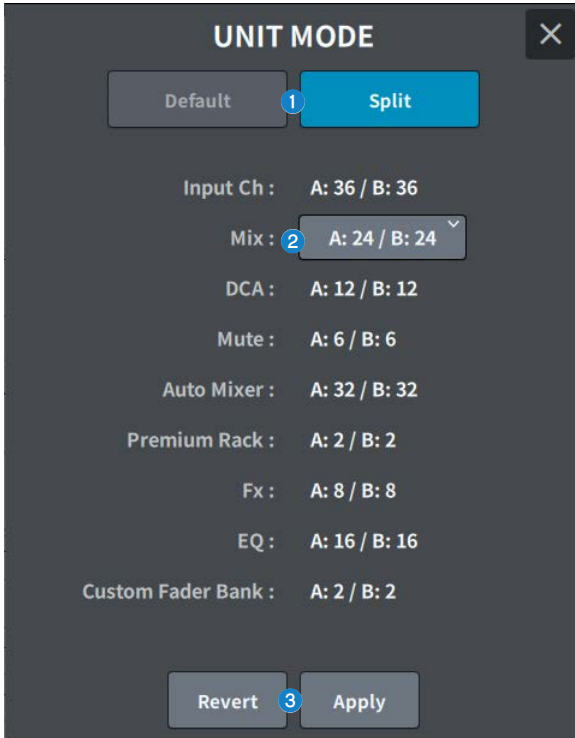

1 Default/Split button

Selects the mode.

For details, refer to “Using Split Mode” (p.418) .

2 Mix bus distribution select button

Select from the options below:

- A:12 / B:36
- A:24 / B:24
- A:36 / B:12

3 Revert/Apply button

Determines mode change.

MAINTENANCE Screen

This screen is used to perform maintenance on the DM7 Series. To display the Maintenance screen, press and hold down the [SEL] key for channel D in the Main section while turning on the power to the unit.

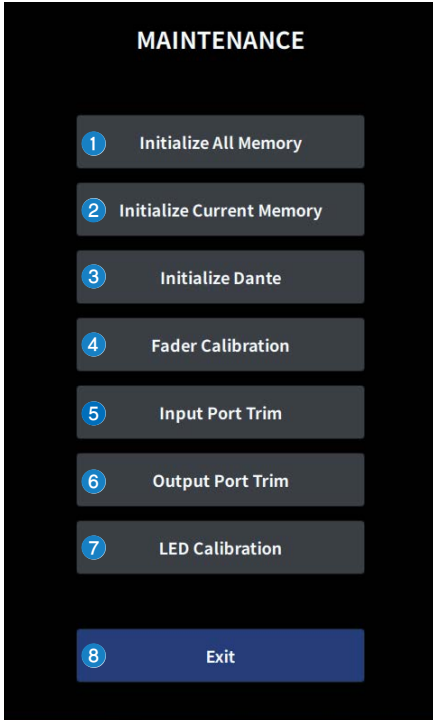

- 1 **Displays the Initialize All Memory screen.** (“Initialize All Memory Screen” (p.310))
- 2 **Displays the Initialize Current Memory screen. (Initialize Current Memory Screen)**
- 3 **Displays the Initialize Dante screen.** (“Initialize Dante Screen” (p.312))
- 4 **Displays the Fader Calibration screen.** (“FADER CALIBRATION Screen” (p.313))
- 5 **Displays the Input Port Trim screen.** (“INPUT PORT TRIM Screen” (p.314))
- 6 **Displays the Output Port Trim screen.** (“OUTPUT PORT TRIM Screen” (p.315))
- 7 **Displays the LED Calibration screen.** (“LED CALIBRATION Screen” (p.316))
- 8 **Closes the Maintenance screen.**

Initialize All Memory Screen

On the Initialize All Memory screen, all the memory, including scene memory and libraries, are restored to factory defaults.

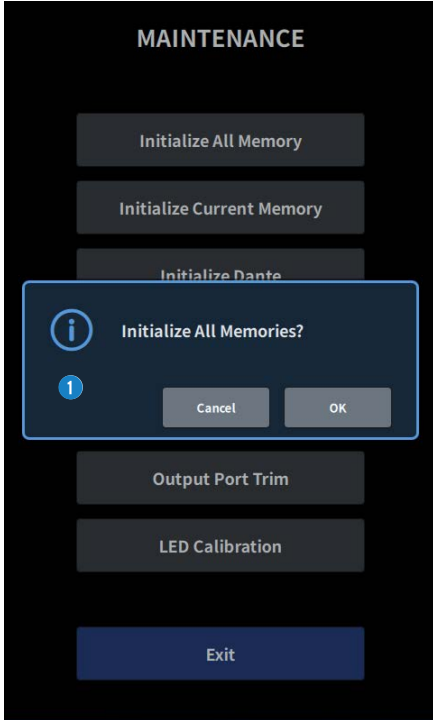

1 Initialize internal memory.

The data to be initialized are all scenes, all presets, mixing data, and setup data.

Touch the OK button to execute the initialization.

NOTE

- When you initialize the internal memory, all content that had been saved in memory will be lost, so please perform this operation with caution.
- The internal storage is also initialized. Configuration files stored in the internal storage will also be deleted, save the important data to USB storage before initialization.
- The Network settings are also initialized.
- The DANTE modules are also initialized.
- The internal clock is retained even after initialization.
- If a DANTE device is connected, it is recommended to cycle the power to reconfigure the connected DANTE device.

Initialize Current Memory Screen

On the Initialize Current Memory screen, all the current memory, including scene memory and libraries, are restored to factory defaults.

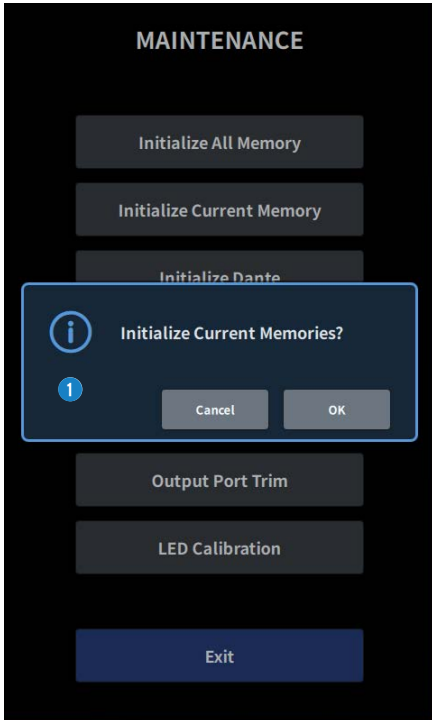

1 Initialize current memory.

The data to be initialized are the mixing data and setup data.

Touch this to display the screen which confirms the operation. Touch the OK button to execute the initialization.

After initialization has been completed, you can continue to select other menus without touching the Exit button.

NOTE

- When you initialize the current memory, all content that had been saved in current memory will be lost, so please perform this operation with caution.
- Dante Setup data was not initialized.

Initialize Dante Screen

On the Initialize Dante screen, the DM7's DANTE module settings are initialized.

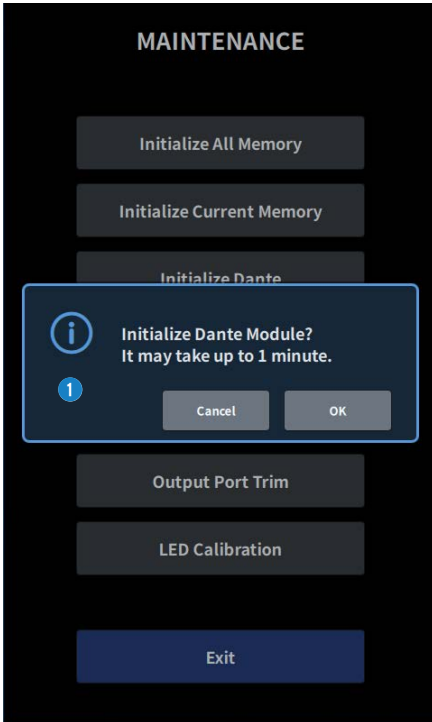

- 1 Initialized the DM7 main unit DANTE module settings. If a DANTE device is connected, it is recommended to cycle the power on the DM7 to reconfigure the connected DANTE device.

NOTE

- Initialization will proceed even if the Dante Device Lock has been applied. In this case, the Dante Device Lock is canceled after the initialization.
- The Dante Domain Manager domain registration will be erased.
- A label corresponding to the DM7 input/output channel is written to the Dante Channel Label for Receive/Transmit.

FADER CALIBRATION Screen

Depending on the environment in which you use the system, discrepancies may occur in the motion of the motorized faders. These misalignments in behavior can be adjusted on the FADER CALIBRATION screen.

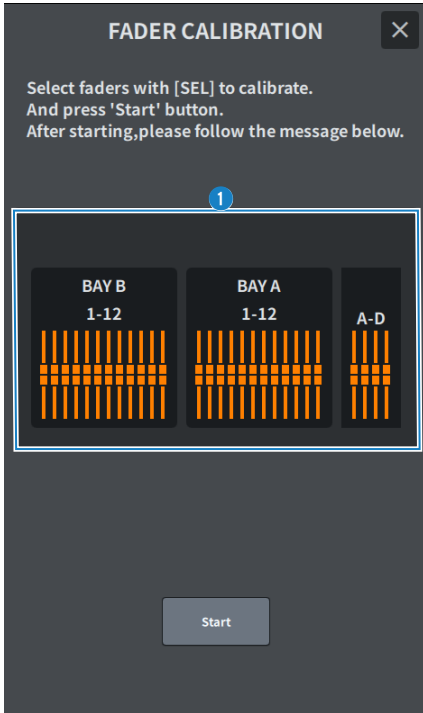

1 Fader

Perform adjustments according to the messages displayed.

INPUT PORT TRIM Screen

The INPUT PORT TRIM screen is used to fine-tune the gain of the specified input port in 0.01 dB increments.



1 Input gain button

Allows you to select the input ports to adjust.

Select the input port, and rotate the channel D screen encoder to adjust the value.

After adjustment, restart in normal mode.

2 Reset All button

Everything is set to 0 dB. The factory default is also 0 dB.

Touch this to display the screen which confirms the operation. Touch the OK button to perform the reset.

NOTE

After the reset, you can continue to select other menus without touching the Exit button.

OUTPUT PORT TRIM Screen

The OUTPUT PORT TRIM screen is used to fine-tune the gain of the specified input port in 0.01 dB increments.

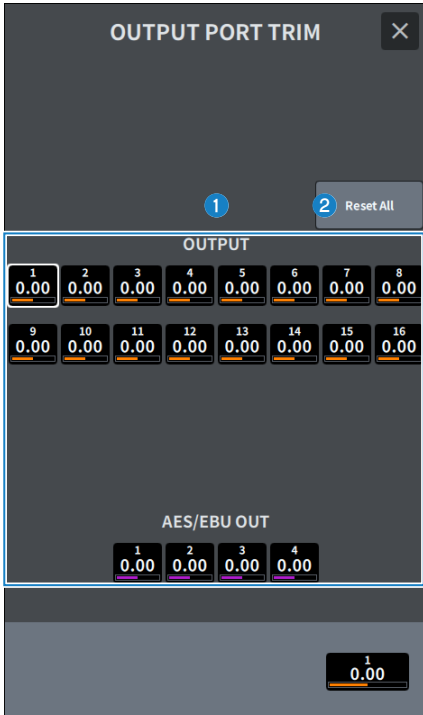

1 OUTPUT gain button

AES/EBU OUT gain button

Allows you to select the output ports to adjust.

Select the output port, and rotate the channel D screen encoder to adjust the value.

After adjustment, restart in normal mode.

2 Reset All button

Everything is set to 0 dB. The factory default is also 0 dB.

Touch this to display the screen which confirms the operation. Touch the OK button to perform the reset.

NOTE

After the reset, you can continue to select other menus without touching the Exit button.

LED CALIBRATION Screen

The LED CALIBRATION screen is used to adjust the color and brightness of the selected LEDs.

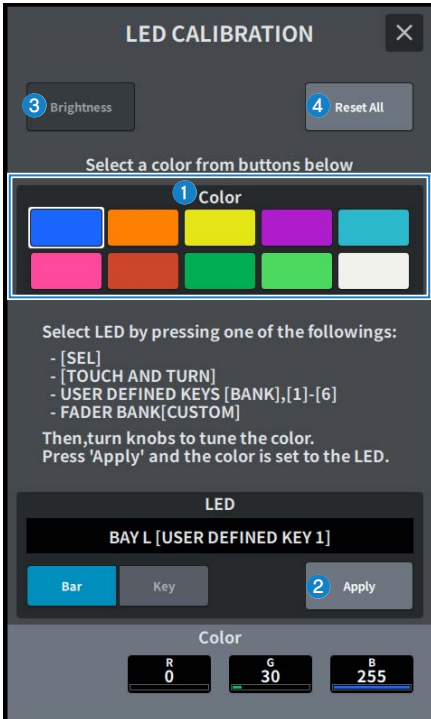

1 Color

Sets the color of the top panel LEDs.

- [SEL] key
- [TOUCH AND TURN] knob
- USER DEFINED KEYS [BANK], [1]-[6] key
- FADER BANK [CUSTOM] key

2 Apply button

Reflects the adjustment and exit.

3 Brightness button

Sets the brightness of the LEDs and channel colors on the top panel.

- Color Bar • • • Brightness of the channel colors on the top panel
- Panel • • • Brightness of the LEDs on the top panel

4 Reset All button

All Color settings will be reset to the factory default values.

Touch this to display the screen which confirms the operation. Touch the OK button to perform the reset.

NOTE

After the reset, you can continue to select other menus without touching the Exit button.

Sound Operations

Controlling GAIN via the OVERVIEW Screen

- 1 Press the [HOME] key to display the OVERVIEW screen.**
- 2 Press the A.Gain button.**
The Gain screen is displayed.
- 3 Set the HA using the buttons on the screen.**
Use the screen encoder or [TOUCH AND TURN] knob, or touch the screen and then slide up, down, left, or right to set the HA.
- 4 Perform the same operations for other input channels as desired.**
When the Gain screen is displayed, you can also use the [SEL] keys to switch the channel for editing.
- 5 When you finish configuring the settings, press the × symbol in the upper right of the screen.**

Related links

“12ch Gain screen” (p.261)

Controlling the EQ via the OVERVIEW Screen

- 1 Press the [HOME] key to display the OVERVIEW screen.**
The EQ field shows the EQ characteristics.
- 2 Select the channel that you want to control.**
- 3 Press the EQ field.**
The EQ screen is displayed and you will be able to adjust all of the EQ parameters.
- 4 Use the touchscreen or corresponding screen encoder to adjust the EQ parameters.**
- 5 When you finish configuring the settings, press the × symbol in the upper right of the screen.**

Related links

“EQ Screen” (p.68)

Controlling the EQ via the SELECTED CHANNEL VIEW Screen

- 1 Press the [HOME] key to display the SELECTED CHANNEL HOME screen.**
The EQ field shows the EQ characteristics.
- 2 Select the channel that you want to control.**
- 3 Press the expand button in the upper left corner of the EQ field.**
The EQ screen is displayed and you will be able to adjust all of the EQ parameters.
- 4 Use the touchscreen or corresponding screen encoder to adjust the EQ parameters.**
- 5 After completing the settings, press the collapse button in the upper left corner of the screen.**

Related links

[“EQ Screen” \(p.68\)](#)

Controlling the Dynamics Processor via the OVERVIEW Screen

1 Press the [HOME] key to display the OVERVIEW screen.

You can check the dynamics processor on/off status and the amount of gain reduction for the DYN1/2 field.

2 Select the channel that you want to control.

3 Press the DYN 1/2 field.

The DYNAMICS screen is displayed and you can edit the dynamics settings and turn the processor on/off.

4 Press the DYN1/2 ON button to adjust the dynamics parameters.

5 When you finish configuring the settings, press the × symbol in the upper right of the screen.

Related links

“DYNAMICS Screen” (p.73)

Controlling the Dynamics Processor via the SELECTED CHANNEL VIEW Screen

- 1 Press the [HOME] key to display the SELECTED CHANNEL HOME screen.**
- 2 Select the channel that you want to control.**
- 3 Press the expand button in the upper left corner of the DYN1/2 field.**
The DYN1/2 screen is displayed.
- 4 Use the touchscreen or corresponding screen encoder to adjust the dynamics parameters.**
- 5 After completing the settings, press the collapse button in the upper left corner of the screen.**

Related links

[“DYNAMICS Screen” \(p.73\)](#)

Controlling Inserts via the OVERVIEW Screen

- 1 Press the [HOME] key to display the OVERVIEW screen.**
- 2 Press the Insert field for the channel into which you want to insert.**
The INSERT screen is displayed.
- 3 Press the Insert block button for the external device you want to assign, and select Outboard.**
- 4 Press the Output patch select button, and the patch select screen is displayed.**
- 5 Specify the output port that you want to use as the insert out.**
- 6 Press the Input patch select button, and the patch select screen is displayed.**
- 7 Specify the input port that you want to use as the insert in.**
- 8 If necessary, configure the insert settings for other channels in the same way.**
- 9 When you finish configuring the settings, press the × symbol in the upper right of the screen.**

Related links

“Insert screen” (p.264)

Controlling Inserts via the SELECTED CHANNEL VIEW Screen

- 1** Press the [HOME] key to display the SELECTED CHANNEL HOME screen.
- 2** Select the channel that you want to control.
- 3** Press the Insert button.
The Insert screen is displayed.
- 4** Press the Insert block button for the external device you want to assign, and select Outboard.
- 5** Press the Output patch select button, and the patch select screen is displayed.
- 6** Specify the output port that you want to use as the insert out.
- 7** Press the Input patch select button, and the patch select screen is displayed.
- 8** Specify the input port that you want to use as the insert in.
- 9** If necessary, configure the insert settings for other channels in the same way.
- 10** After completing the settings, press the collapse button in the upper left corner of the screen.

Related links

“Insert screen” (p.264)

Directly Outputting an Input Channel

The input channel signal can be directly output from any desired OMNI OUT jack, or the output channel of any desired card slot.

- 1 Press the D.Out button on the OVERVIEW screen for the input channel you want to output directly.**
The GAIN/PATCH/D.OUT screen is displayed.
- 2 Press the D.Out Patch button, and the patch select screen is displayed.**
- 3 Select the output port to be used for direct output and press the × symbol.**
This returns to the GAIN/PATCH/D.OUT screen.
- 4 Use the D.Out Patch point to switch the point from which the Direct Out signal is acquired.**
- 5 Use the Level field to adjust the Direct Out's output level.**
Use the screen encoder or [TOUCH AND TURN] knob, or touch the screen and then slide up, down, left, or right to adjust the level.
- 6 Press the D.Out ON button to turn this ON.**
Direct output is now enabled. Adjust the input level and other settings on the external device as necessary.
- 7 If necessary, configure Direct Out settings for other channels in the same way.**

Related links

“12ch D.Out screen” (p.263)

Controlling the Delay via the OVERVIEW Screen

1 Press the [HOME] key to display the OVERVIEW screen.

2 Press the Delay field to display the DELAY popup window.

3 Set the delay using the buttons on the screen.

Use the screen encoder or [TOUCH AND TURN] knob, or touch the screen and then slide up, down, left, or right to adjust the delay.

4 Perform the same operations for other channels as desired.

If you are viewing the 12ch DELAY popup window, you can use the [FADER BANK] section to switch the channels being controlled in groups of twelve. You can also press the section displaying the meter area to switch channels.

5 When you finish making settings, press the × symbol in the upper right of the window.

Related links

“Delay screen” (p.265)

Controlling the Delay via the SELECTED CHANNEL VIEW Screen

- 1 Press the [HOME] key to display the SELECTED CHANNEL HOME screen.**
- 2 Select the channel that you want to control.**
- 3 Select the Delay button to set the delay.**

Use the screen encoder or [TOUCH AND TURN] knob, or touch the screen and then slide up, down, left, or right to adjust the delay.
- 4 Set the Delay Point as necessary.**

The Delay Point is set on the DELAY screen.
- 5 When you finish making settings, press the × symbol in the upper right of the window.**

Related links

“Delay screen” (p.265)

SENDS TO

By using SENDS TO, you can specify feed of each channel to a specific MIX or MATRIX bus for 12 channels at a time.

- 1 Press the [HOME] key to display the OVERVIEW screen.**
- 2 Press the Send key to display the Send field.**
- 3 Use the Up/Down keys to select the destination bus bank.**
- 4 You can use the Send ON button to turn on/off the signal that is sent from each input or MIX channel to the currently-selected MIX/MATRIX bus.**
- 5 If necessary, use the Pre button to select the send point of the signal that is sent from each input channel, MIX channel, or STEREO channel to a VARI-type MIX bus or MATRIX bus.**

NOTE

- This allows you to flexibly select the send point for each channel.
- The Pre button is not shown for a FIXED-type MIX bus.

- 6 Use the Send Level to adjust the send level.**

Use the screen encoder or [TOUCH AND TURN] knob, or touch the screen and then slide up, down, left, or right to adjust the send level.

Related links

“Send screen” (p.267)

Using the Faders to Adjust the Sends (SENDS ON FADER Mode)

Configure the sends settings using the fader (SENDS ON FADER mode). You can use the top panel faders to adjust the signals that are sent from a specific channel to the MIX/MATRIX buses.

1 Verify that an output port is assigned to the MIX/MATRIX bus to which the signal is sent, and that the corresponding output port is connected to the monitor system or an external effect.

2 Press the [SENDS ON FADER] key on the top panel.

This switches to SENDS ON FADER mode, and the SENDS ON FADER screen is displayed. The faders in the channel strip section move to indicate the send level of the signals that are routed from each channel to the currently-selected MIX/MATRIX bus. The [ON] keys also change to the SEND ON status.

3 Use the MIX/MATRIX bus select buttons to select the send-destination MIX/MATRIX bus.

NOTE

If you press the currently-selected MIX/MATRIX bus select button again, cue monitor turns on for the corresponding MIX/MATRIX channel. This method is convenient when you want to monitor the signal that is being sent to the selected MIX/MATRIX bus.

4 Using the faders from the top panel channel strip section, adjust the send level to the selected MIX/MATRIX bus from the channels that are deployed (rolled out) to the layer.

5 Repeat steps 3–5 to adjust the send levels for other MIX/MATRIX buses in the same way.

6 When you finish adjusting the MIX/MATRIX send levels, press the [SENDS ON FADER] key or the × button in the upper right of the screen.

This exits from SENDS ON FADER mode and switches to normal mode.

Port to Port HA function

This function uses the local I/O of a digital mixer as a simple I/O port to remotely control I/O devices and the input channels of other digital mixers. The digital mixer mounted for control receives the internal patch status of the mounted digital mixer via communication and stores it in memory as "Port to Port Status." You can then refer to "Port to Port Status" to determine whether the port can be controlled. In addition, if you virtually mount a device that supports "Port to Port Status," you can set it offline.

About the Port to Port HA function

Whether the mounted digital mixer can control remote HA is determined by the internal patch settings of the mounted digital mixer. An example of the internal patch of the mounted digital mixer is shown below. There are patterns that enable or disable the Port to Port HA function depending on the internal patch status so that you do not operate a port different from the port you want to change the audio on.

Example of enabling the Port to Port HA function

The Port to Port HA function is enabled when the internal patch is set to Port to Port and DANTE OUT. Also, the port number of the analog input + model-dependent offset must be equal to the port number of the DANTE OUT.

■ DM7

The DM7 has a model-dependent offset defined as "0," allowing you to control it by setting a DANTE OUT with the same port number as the analog input port number.

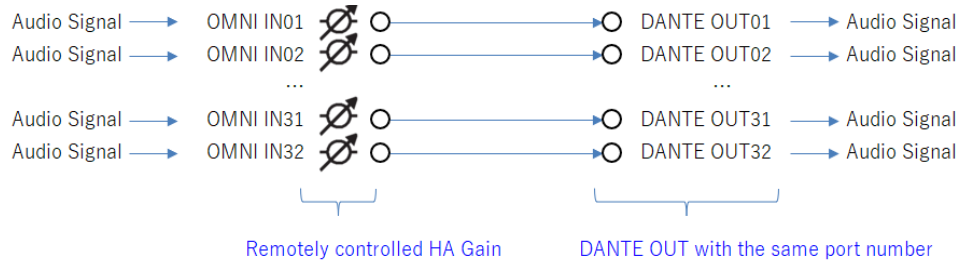

Since the internal patch of an I/O box cannot be changed, you can control a DANTE OUT with the same port number as the analog input port number, just like the DM7.

Example of disabling the Port to Port HA function

■ When the internal patch is disconnected

If the analog input port is not patched to anything, control is not possible.

Sound Operations > Port to Port HA function

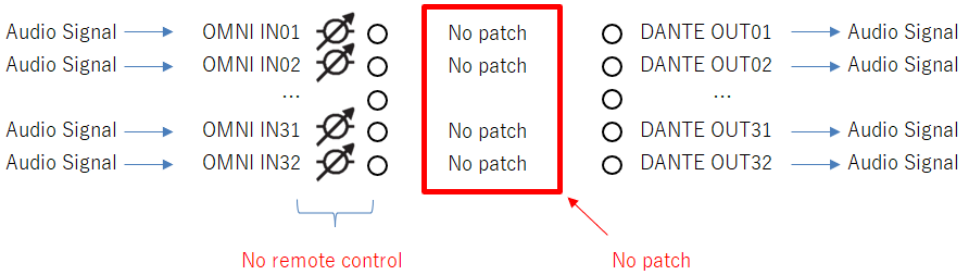

■ When not Port to Port

When the analog input port is not Port to Port and is patched to an input channel, Mix bus, etc., control is not possible.

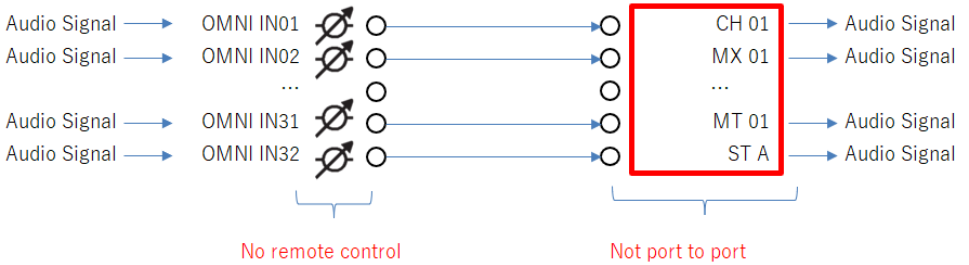

■ When it is Port to Port but not DANTE OUT

When it is Port to Port but the output destination is not DANTE OUT, control is not possible.

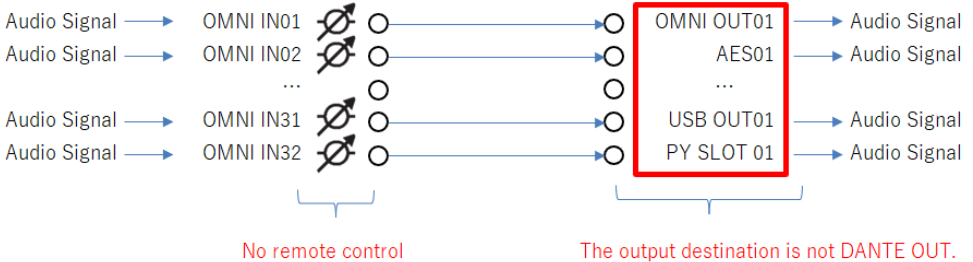

■ When it is Port to Port and DANTE OUT but the patch settings are among different numbers

Control is not possible if the analog input port number plus the model-dependent offset does not correspond to the DANTE OUT port number.

Sound Operations > Port to Port HA function

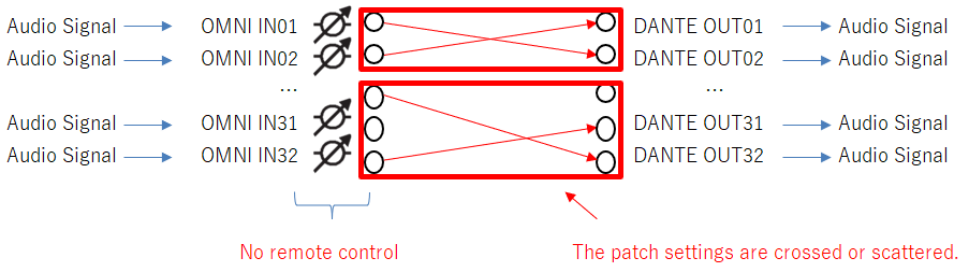

"Port to Port Status" screen display

You can determine on the screen whether or not the port can be controlled by the mounted digital mixer.

■ I/O DEVICE screen

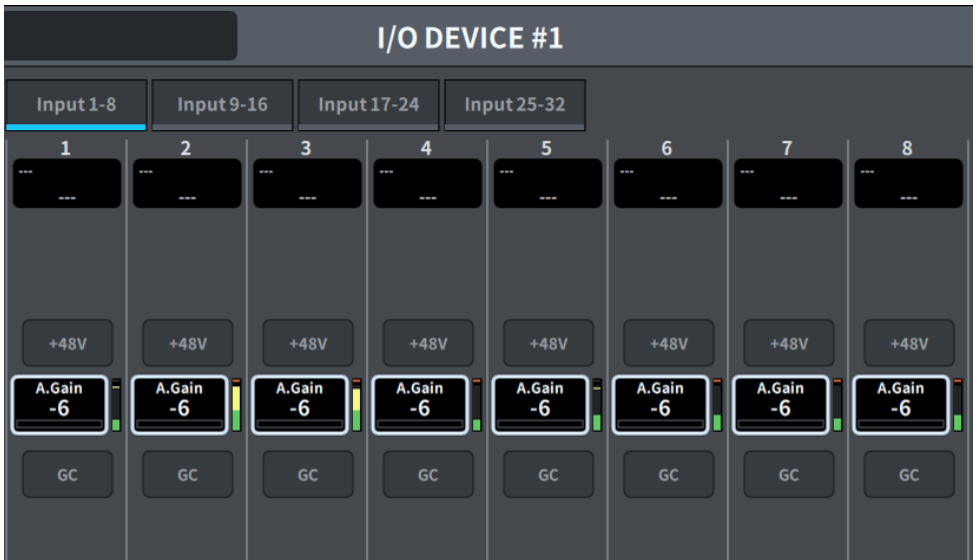

Although the HA parameters can be controlled from the screen, for ports where "Port to Port Status" is disabled, write-back will occur even if you operate from the screen.



As a Remote HA function, when you patch the DANTE IN of the mounted I/O to an input channel, the target HA parameters are displayed, but if the mounted I/O is a digital mixer, ports with a disabled "Port to Port Status" are not displayed.

■ SELECTED CHANNEL VIEW screen

- Port to Port Status : Enabled



- Port to Port Status : Disabled



■ CH PARAMETER screen

- Port to Port Status : Enabled



- Port to Port Status : Disabled



■ **Offline settings for devices that support "Port to Port Status"**

For devices that support Remote HA, parameters are set in the connection sequence when w/ Recall is set to ON, so that offline settings of HA parameters can be made on the mounted digital mixer. Even if the digital mixer is virtually mounted, HA parameters can be changed on the I/O DEVICE screen and each Ch screen. The same applies to the offline Editor.

Mix Minus

This function removes only the signal of a specific channel from the signals sent to the MIX/MATRIX buses. If you use it, you can quickly send a signal with only the voice of the individual removed as a monitor signal for the performer or announcer. By setting the mix minus bus in advance and specifying the Owner channel, you can link the announcer's microphone (input channel) and monitor (mix minus bus) at the relay destination.

1 Press the Setup button on the menu bar.

2 Press the Bus Setup button.

The BUS SETUP screen will be displayed.

3 Press the Mix Minus button.

NOTE

- The send level of the signal sent from the selected Owner channel is reduced to $-\infty$ dB.
- The send level of the signal sent from all input channels other than the selected one is set to nominal level (0.0 dB).
- Also, the send to the destination bus is turned on, and the send point is switched to Post.
- A stereo input channel has a send level of $-\infty$ dB for the signal sent from both channels.

4 Press the N-1 Owner button.

A screen where you can select the Owner channel for mix minus settings (input channels that use mix minus) will be displayed.

5 Select the Owner channel.

Sends from the selected Owner channel will be turned off.

NOTE

This can also be selected by holding down the [SHIFT] key and pressing the N-1 Owner button when Send is displayed on the OVERVIEW screen.

Related links

“BUS SETUP Screen” (p.125)

ST Mode and LCR Mode

The STEREO buses are used for outputting signals to the main speakers. Signals can be sent to a STEREO bus in one of two modes, ST mode or LCR mode, and you can make this selection individually for each channel. These modes differ in the following ways.

ST mode

This method sends signals independently from the input and MIX channels to each of the STEREO A and B buses.

- The signals sent to the STEREO A bus and STEREO B bus can be switched on/off individually.
- The pan of the signal sent from the input channel or MIX channel to L/R of the STEREO A bus or STEREO B bus is controlled by the TO ST PAN knob.

About MONO

By using the L/R PATH pull-down menu in the SELECTED CHANNEL VIEW screen, STEREO B can be set to MONO. If it is set to MONO, the same signal will be output to both the L and R of STEREO B.

LCR mode

This method sends the signals from the input and MIX channels to a total of three buses: STEREO A (L and R) and STEREO B (C) simultaneously.

- The signals sent to the STEREO A bus and STEREO B bus can be switched on/off together.
- The level difference between the signals sent from the input channel or MIX channel to the STEREO A (L and R) buses and to the STEREO B (C) bus can be set using the CSR (center/side ratio) knob.
- The level of the signal sent from the input channel or MIX channel to the STEREO A (L and R) buses and the STEREO B (C) bus will change according to the settings of the TO ST PAN knob and the BALANCE knob.

NOTE

- When using LCR mode, set STEREO B to MONO.
- STEREO B is used as the CENTER channel.

Sending Signals to the STEREO Bus

- 1** Verify that an input source is connected to the channel that you are controlling, and set the head amp's phantom power, gain, and phase to obtain the optimal input signal.
- 2** Press the Pan/Balance button in the OVERVIEW screen or the SELECTED CHANNEL VIEW screen of the input channel or MIX channel whose signal you want to send to the STEREO A bus and STEREO B bus.
The TO STEREO popup window is displayed.
- 3** Use the ST/LCR mode select button to select either ST mode or LCR mode for each channel.
- 4** In the channel strip section of the top panel, verify that the [ON] key is turned on for the input channel or MIX channel that you want to operate, and then raise the fader to the appropriate position.
- 5** In the channel strip section of the top panel, verify that the [ON] key is turned on for the STEREO channel that you want to operate, and then raise the fader to the appropriate position.

Related links

["To Stereo screen"](#) (p.269)

About DCA

You can use the 24 DCAs to control the level of multiple channels simultaneously.

It has the following features:

- DCA1–24 can be used for all input channels and all output channels.
- Both input and output channels can be mixed in the same group.
- All channels assigned to a DCA can be cued simultaneously.
- You can monitor the corresponding DCA at unity gain (which is equivalent to the level obtained when the DCA fader is set to 0 dB).

NOTE

DCA settings are saved as part of the scene.

Related links

“DCA GROUP ASSIGN Screen” (p.217)

Assigning Channels to the DCA

- 1 Press the DCA/Mute Assign field on the OVERVIEW screen, or press the DCA/Mute button on the SELECTED CHANNEL VIEW screen.**
DCA/Mute Assign is displayed.
- 2 Press a DCA Assign buttons to select the DCA to which the currently-selected channel will be assigned (multiple selections are allowed).**
- 3 Select the DCA(s) for other channels in the same way.**

Related links

“DCA GROUP ASSIGN Screen” (p.217)

Using DCAs

- 1 Assign input channels and output channels to a DCA.**
- 2 Using the faders in the channel strip section of the top panel, adjust the relative balance between the input channels and output channels that belong to the DCA you want to use.**
- 3 Press the [DCA/DAW] key in the fader bank to light it up and call up the DCA you want to use.**
- 4 In the channel strip section, operate the fader corresponding to the DCA you want to use.**

The level of the channels assigned to that DCA will change while preserving the level differences you established in Step 2.

NOTE

Operating a DCA fader will not cause the input faders to move in tandem.

- 5 To switch a DCA between on and mute, press the [ON] key for that DCA.**
When you press an [ON] key to make the key indicator go dark, the [ON] key for each channel assigned to that DCA will flash, and these channels will be muted (the same state as when the faders are lowered to the $-\infty$ dB position).
- 6 To cue-monitor a DCA, press the [CUE] key for that DCA.**
When you press the [CUE] key to make the key indicator light turn on, cue monitoring for the channels assigned to that DCA will be enabled. For more information about cue, refer to “Using the Cue Function” (p.382) .

NOTE

In the channel strip section, you can also operate the DCA by pressing the [FADER BANK] section.

DCA Scene Grid (Theater Package Compatible)

This section describes how to set up a DCA Scene Grid, which supports the use case of changing DCA assignments for each scene in a theater application.

- 1 Press the Ch Job button on the Menu bar.**
- 2 Press the DCA Group button to display the DCA GROUP ASSIGN screen.**
- 3 Press the Preset editing button to prepare DCA Presets as needed.**
- 4 Press the DCA Scene Grid button.**
The DCA SCENE GRID screen will be displayed.
- 5 Press DCA Grid to assign a DCA for each scene.**

Related links

- “DCA GROUP ASSIGN Screen” (p.217)
- “DCA SCENE GRID Screen (Theater Package Compatible)” (p.219)

About MUTE Groups

Twelve mute groups are available and they have the following features:

- Mute groups 1–12 can be used for all input channels and all output channels.
- Both input and output channels can be mixed in the same group.
- You can temporarily cancel the mute for individual channels.
- You can also assign a mute group control function to a USER DEFINED key.
- The mute group can not only be completely muted, but the attenuation amount can also be adjusted by the DIMMER function.
- The MUTE SAFE function allows you to exclude (make SAFE) specific channels from the Mute Group function.
- You can change the name of the mute group control.

Temporary Unmute Function During Mute

Temporary Unmute Function During Mute

You can temporarily cancel the Mute function for specific channels in a mute group by pressing the corresponding channel [ON] keys.

NOTE

The [ON] key can temporarily unmute a mute group when Preference > [ON] keys > During MUTE is set to "Override".

ON button flash operation

On the SELECTED CHANNEL VIEW and METER screens, the ON button for any channel muted by the mute group will flash.

Assigning Channels to a Mute Group

- 1 Press the DCA/Mute Assign field on the OVERVIEW screen, or press the DCA/Mute button on the SELECTED CHANNEL VIEW screen.**
DCA/Mute Assign is displayed.
- 2 Press the Mute Assign button to select the MUTE group to which the currently-selected channel will be assigned (multiple selections are allowed).**
- 3 Select the mute group(s) for other channels in the same way.**

Related links

“MUTE GROUP ASSIGN screen” (p.220)

Channel Link

Channel link is a function that links the operations (such as fader movements or EQ parameters) of input channels or output channels. Two or more channels that are linked are called a link group. You can create up to 52 link groups for input channels and up to 30 link groups for output channels. The type of parameters to be linked can be individually selected for each link group. However, input and output channels cannot be mixed in a single link group. While a pairing is limited to use on two adjacent channels, the Channel Link function allows multiple channels to be combined and linked.

- 1 Press the Ch Job button on the menu bar, and then select Ch Link.**
When you select Ch Link, the CH LINK MODE screen is displayed.
- 2 Press an INPUT/OUTPUT button to select the channels that you want to link.**
- 3 Link channels by holding down the [SEL] key of the link-source channel and pressing the [SEL] key of the link-destination.**
- 4 Use the buttons in the LINK PARAMETER field on the CH LINK MODE screen to select the parameters that you want to link.**
- 5 Press the × symbol to close the CH LINK screen.**

Related links

“CH LINK screen” (p.222)

Types of Channel Links

Types of Channel Links

- Linking three or more channels
Hold down the [SEL] key of the link-source, and press the [SEL] keys of the input channels that you want to add to the link group in succession.
- Adding new channels to an existing link group
Hold down any [SEL] key within the group, and press the [SEL] keys that you want to add to the group.
- Canceling a link
Hold down any [SEL] key that is registered within the same link group, and press the [SEL] key of the channel that you want to remove from the group.
- Editing the level balance between channels assigned to a link group
Hold down the [SEL] key of any linked channel, and work on the parameter that you want to edit.

Temporary Link

This function creates a temporary link between multiple channels and links only the operated parameters between channels. This is useful when you want to apply fader operations or EQ adjustments to multiple channels, as it is faster than copying or recalling and in real time. Since it is not a permanent link, only one group can be linked, but there is no limit to the number of channels. However, input channels and output channels cannot be mixed in temporary links.

The list of linked parameters is shown below.

Gain and level have relative behavior.

For input channels:

- Digital gain and analog gain settings
- Insert on/off and point settings
- Direct out on/off, level, point, and follow settings
- HPF settings
- LPF settings
- PEQ settings
- Dynamics settings
- Delay settings
- On/off, level, Pre/Post, and follow settings for signals sent to MIX buses
- On/off, level, Pre/Post, and follow settings for signals sent to MATRIX buses
- TO STEREO settings
- DCA/Mute Assign settings
- Fader operations
- [ON] key operations
- Input patch settings
- Order of EQ and DYN2

For output channels (excluding stereo channels):

- Insert on/off and point settings
- HPF settings
- LPF settings
- PEQ settings
- Dynamics settings
- Delay settings
- On/off, level, Pre/Post, and follow settings for signals sent to MATRIX buses
- TO STEREO settings
- DCA/Mute Assign settings

Sound Operations > Temporary Link

- Fader operations
- [ON] key operations
- Order of EQ and DYN2

Temporarily Linking Channels

Hold down the [SHIFT] key and press the [SEL] key to temporarily link. The meter area and the channel name at the bottom of the screen are enclosed in a yellow frame, and a link symbol is displayed. The [SEL] key of the set channel will flash.

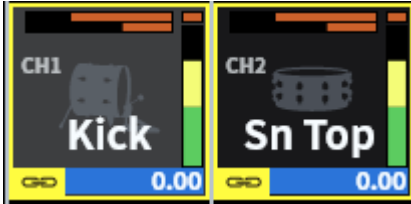

If you press the [SEL] key of a channel that is not temporarily linked, the temporary link will be canceled. The temporary link will also be canceled if you turn off the power or load a file. The temporary link will continue even if a scene is recalled, but will be canceled if the pair settings of the temporarily linked channels are changed.

Copying Channel Parameters

You can copy channel mix parameter settings to other channels. When the copy operation is executed, the parameter settings will overwrite those of the copy destination. You can copy parameter settings between the following channel combinations.

- Between input channels
- Between MIX channels
- Between MATRIX channels

NOTE

Patch, channel name, and phantom settings will not be copied.

1 Press the Ch Job button on the menu bar, and then select Ch Copy.

When you select Ch Copy, the CH COPY screen is displayed.

2 Select the copy source channel.

Once you select the copy source channel, the system automatically switches to a mode that allows you to select the copy destination. The fader graphics for the copy source channel will be highlighted in green.

3 Select the copy destination channels (multiple selections are allowed).

The fader graphics for the copy destination channels will be highlighted in pink.

4 To execute the copy operation, press the Paste button.

The copy operation will be executed, and the parameter settings will overwrite those of the copy destination.

5 Press the × symbol to close the CH COPY screen.

Related links

“CH COPY screen” (p.224)

Initializing Channel Parameters

This restores the channel parameters to their initial values. This operation can be performed on any channel.

NOTE

Channel name, patch, and Recall Safe settings will not be initialized.

- 1 Press the Ch Job button on the menu bar, and then select CH Default.**
When you select CH Default, the CH DEFAULT screen is displayed.
- 2 Select the channel that you want to initialize (multiple selections are allowed).**
The corresponding channel will be highlighted.
- 3 To execute the initialization, press the Default button.**
A dialog box will ask you to confirm the Initialization operation.
- 4 Press the OK button in the confirmation dialog box.**
The parameters of the selected channel will be initialized.
- 5 To close the CH DEFAULT screen, press the CLOSE button.**

Related links

“CH DEFAULT screen” (p.225)

DSP Resource Management for Premium / FX / GEQ Rack

Plug-ins and GEQ/PEQ each have their own dedicated DSP resources, and DSP resources are consumed each time they are inserted or rack mounted. A Premium Rack can use 64 DSP resources (16 x 4 groups), an FX Rack can use 16 DSP resources, and a GEQ/PEQ can use 32 DSP resources. Please refer to the documentation for information on the DSP resources used by the relevant plug-in and GEQ / PEQ.

GEQ/PEQ

About Using a Graphic EQ (GEQ)

31BandGEQ

This is a monaural 31-band GEQ. The bandwidth is in 1/3-octave increments, and the variable gain ranges are ± 15 dB, ± 12 dB, ± 6 dB (both boost and cut directions), and -24 dB (cut direction only), allowing gain adjustment in all 31 bands.

Flex15GEQ

This is a monaural 15-band GEQ. The bandwidth is in 1/3-octave increments, and the variable gain ranges are ± 15 dB, ± 12 dB, ± 6 dB (both boost and cut directions), and -24 dB (cut direction only). The Flex15 GEQ allows you to manipulate the gain on up to 15 bands (similarly, up to 31 bands for the 31 Band GEQ) once you have used up the 15 bands, you cannot adjust the gain of a new band until you return one of the already set bands to flat. The GEQ features a 1/12 oct (121-band) Real Time Analyzer (also called a spectrum analyzer). If you are using a stereo source, you can link the two GEQ units.

About using a parametric EQ (PEQ)

8BandPEQ

This is a monaural 8-band PEQ. It also features four notch filters. The PEQ can use a 1/12 oct (121-band) Real Time Analyzer (also called a spectrum analyzer).

NOTE

Notch filters A–D are independent of the PEQ, and thus not affected by the PEQ's BYPASS buttons. It is also possible to set the PEQ to BYPASS and use only the notch filters.

Inserting a GEQ/PEQ into a Channel via the SELECTED CHANNEL VIEW Screen

This section describes how to insert and use GEQ/PEQ on the selected channel.

- 1 Select the channel that you want to control.**
- 2 Press the Insert button.**
The Insert screen is displayed.
- 3 Use the INSERT [A]–[D] buttons to select an insert block which you want to assign to the GEQ/PEQ.**
- 4 Press the button to display the select screen.**
- 5 Select the item to be inserted.**
- 6 Press the OK button to allocate the GEQ/PEQ.**

Related links

“Insert screen” (p.264)

About Plug-ins

Plug-ins can be used by inserting them into a channel, or via send or return. The DM7 Series offers 30 different types of plug-ins. The maximum number of plug-ins that can be mounted depends on the type of plug-in. For details on the amount of DSP resources that each plug-in uses, refer to the plug-in type list.

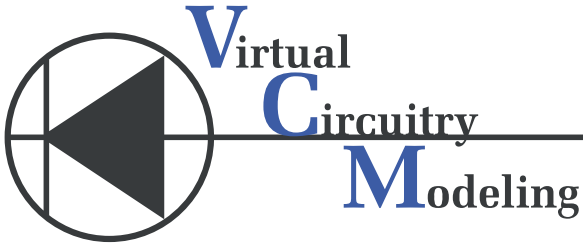

VCM (Virtual Circuitry Modeling) is a technology for modeling analog circuits at the element level (resistors, capacitors, etc.). Plug-ins use VCM technology.

The following functionality is also provided.

- The plug-in mount status and parameters can be saved in scene memory.
- There is a "Plug-in library" that lets you store and recall plug-in parameters.
- Tap tempo functionality can be used for plug-ins that support it. Tap tempo can be used via a USER DEFINED key or GPI.

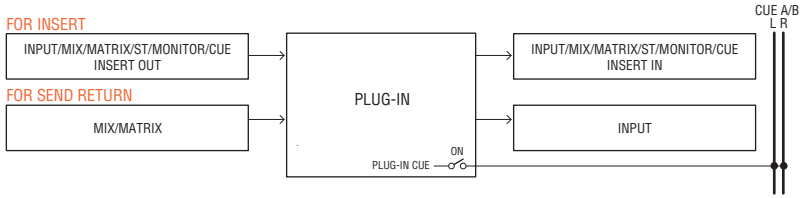

FOR INSERT (例)

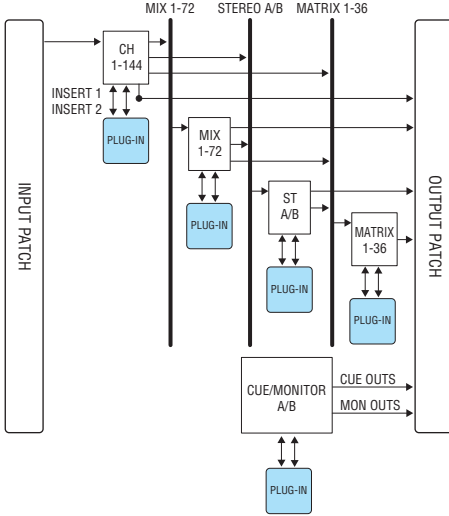

FOR SEND RETURN (例)

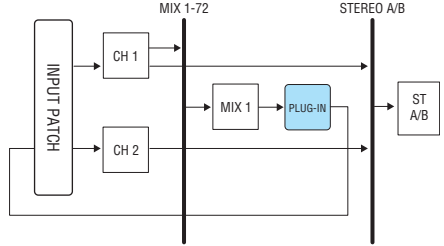

Plug-in type list

Premium Rack

Plug-in type	Explanation	Amount of DSP resources	Tap tempo function
REV-X	A 2-in/2-out reverb algorithm that provides a high-density, richly reverberant sound quality, smooth attenuation, and spaciousness and depth that enhance the original sound. You can choose one of three programs to suit the acoustic environment and your purpose: REV-X Hall, REV-X Room, and REV-X Plate.	6	-
Analog Delay	Dual Stereo This delay effect is based on the Yamaha E1010 analog delay	4	✓
Max100	Complete reproduction of a vintage effect that was manufactured only during the late 1970s.	1	✓
Dual Phaser	Complete reproduction of a vintage effect that was manufactured during the middle of the 1970s.	1	✓

Plug-in type		Explanation	Amount of DSP resources	Tap tempo function
OpenDeck		This mastering plug-in emulates the tape compression created by two open reel tape recorders (a recording deck and a reproduction deck).	4	-
Vintage Phaser		This is a model of phaser that provides a high degree of sound-shaping flexibility, and is not intended as a reproduction of any specific model.	2	✓
HQ. Pitch		A monaural pitch shifter that produces a stable effect.	4	✓
Portico 5033	Dual Stereo	Models an analog 5-band EQ made by Rupert Neve Designs.	2	-
EQ-1A	Dual Stereo	Models a classic vacuum tube passive-type vintage EQ.	3	-
Equalizer601		An equalizer that emulates the characteristics of an analog equalizer used in the 1970s. It can be used to obtain a sense of drive.	2	-
DynamicEQ	Dual Stereo	EQ that dynamically changes the gain, allowing the cut/boost amount to be controlled in response to the input level.	2	-
Dynamic EQ4	Dual Stereo	This is a two-band dynamic equalizer that has been expanded to feature four bands.	3	-
Portico 5043	Dual Stereo	Models an analog compressor/limiter made by Rupert Neve Designs.	2	-
Portico 5045	Dual Stereo	Models the Primary Source Enhancer made by Rupert Neve Designs.	2	-
U76	Dual Stereo	Models a classic vintage compressor/limiter.	3	-
Opt-2A	Dual Stereo	Models a classic vacuum tube (optical type) compressor.	4	-
Comp276 Comp276S	Mono Stereo	This compressor emulates the characteristics of an FET gain reduction compressor commonly used in recording studios.	2	-
Buss Comp 369	Dual Stereo	This compressor emulates a standard bus compressor that is standard in recording studios and broadcasting stations.	3	-
MBC4	Dual Stereo	This four-band compressor offers intuitive operability.	3	-
DaNSe	Dual Stereo	A Dynamic Noise Suppressor with excellent sound quality and operability.	3	-

FX Rack

Plug-in type	Explanation	Amount of DSP resources	Tap tempo function
HD Hall	This reverb simulates concert hall ambience.	2	-
HD Room	This reverb simulates room acoustics.	2	-
HD Plate	This reverb simulates plate echo.	2	-
Space Simulator	This reverb allows configuration of the virtual space using width, height, and depth.	2	-
Gate Reverb	This produces the early reflected sound of a gated reverb.	1	-
R3 Hall	A reverb that simulates concert hall ambience using the same algorithm as ProR3.	2	-
R3 Room	A reverb that simulates room acoustics using the same algorithm as ProR3.	2	-
R3 Plate	A reverb that simulates a plate reverb using the same algorithm as ProR3.	2	-
Early Ref.	2IN/2 OUT early reflections. An effect in which only the early reflected sound of the reverb is extracted.	1	-
Reverb Gate	2 IN/2 OUT gate reverb.	1	-
Hall	This hall reverb program is directly from the SPX1000.	2	-
Room	This room reverb program is directly from the SPX1000.	2	-
Stage	This stage reverb program is directly from the SPX1000.	2	-
Mono Delay	Basic 2IN/2 OUT repeat delay.	1	✓
Stereo Delay	Basic 2 IN/2 OUT stereo delay.	1	✓
Delay LCR	2 IN/2 OUT 3-tap delay.	1	✓
Cross Delay	This is a type of delay in which the delay sound jumps left and right.	1	✓
Tempo Cross Delay	A type of cross delay that synchronizes the delay time with the tempo.	1	✓
Echo	2 IN/2 OUT stereo delay with cross-feedback loop.	1	✓
Ping Pong Delay	2 IN/2 OUT ping pong delay. A delay effect in which the delay sound is repeated at equal intervals alternately on the left and right.	1	✓
Analog Delay Modern	A simulation effect of analog delay using a BBD element. The BBD element's configuration is the long delay configuration.	1	-
Analog Delay Retro	A simulation effect of analog delay using a BBD element. The BBD element's configuration is the short delay configuration.	1	-
Chorus	2 IN/2 OUT chorus effect.	1	✓
Symphonic	2 IN/2 OUT symphonic effect.	1	✓
Flanger	2 IN/2 OUT flange effect.	1	✓

Plug-in type	Explanation	Amount of DSP resources	Tap tempo function
Phaser	2 IN/2 OUT 16-stage effect.	1	✓
Auto Pan	An effect that periodically moves the sound image (pan) left and right.	1	✓
Ring Mod	An effect that changes the input sound to a metallic sound.	1	-
G Chorus	This is a chorus effect that produces a deep sound with complex modulation.	1	✓
Classic Flanger	This is a flanger that produces a natural modulating sound.	1	✓
Dyna. Phaser	A stereo phaser that uses 16 stages of phase shift.	1	-
Tremolo	An effect that periodically changes the volume.	1	✓
Dyna. Ring Mod.	An effect that controls the Ring Modulator parameter "OSC Freq" in real time with the input audio level.	1	-
Ens. Detune	This is a chorus effect without any modulation, by adding a slightly shifted pitch sound.	1	-
VCM Flanger	This is a flanger that uses VCM technology.	1	✓
Rotary Speaker	An effect that simulates a rotary speaker.	1	-
Dual Pitch	2 IN/2 OUT pitch shift effect.	1	✓
Dyna. Filter	A filter that controls the cutoff frequency in real time with the input audio level.	2	-
Symphonic	This is Yamaha's original 2-in/2-out symphonic effect, which provides a richer and more complex modulation effect than chorus.	1	✓
Amp Simulator	An effect that simulates a guitar amp.	1	-
Comp Distortion	A compressor + distortion effect.	1	-
M. Band Comp	An effect that divides the bandwidth into three bands and applies a compressor to each band separately.	1	-
VCM Auto Wah	Auto-wah that uses VCM technology. Periodically changes the center frequency of the filter.	2	✓
Auto Synth	An effect that resynthesizes the input signal by combining the delay and modulation.	2	-
Isolator	An effect that controls the volume per band using a powerful filter.	1	-

NOTE

Plug-ins are categorized into two types: Dual plug-ins that are used by two monaural channels; and Stereo plug-ins that are used by a single stereo channel.

Related links

- “RACK screen” (p.247)
- “FX Parameters” (p.439)

Live Rec

By installing the Yamaha Console Extension, software that links the DM7 Series with Nuendo Live, it is possible to control Nuendo Live from the DM7 Series for easy multi-track recording and other functions.

To prepare for this, configure the necessary settings for Dante (Dante Virtual Soundcard and Dante Controller settings) or connect a USB flash drive.

NOTE

In addition to Nuendo Live, Nuendo and Cubase can also be linked.

- 1 Press the Live Rec button on the menu bar to access the LIVE REC screen.**
- 2 Press the Easy Rec button to start recording.**
- 3 When recording is finished, press the record lock button and then the STOP button. Recordings created in Nuendo Live are saved as projects.**

About Automixer

Automixer detects effective audio from multiple microphones and automatically optimizes the gain distribution for multiple live microphones in unscripted speech situations. In this way, the sound engineer can maintain consistent system gain over multiple microphones without having to focus on the operation of multiple faders.

Principles of Automixer operation

Automixer employs the Dugan Speech System, which automatically adjusts the automix gain of up to 64 live speech microphones.

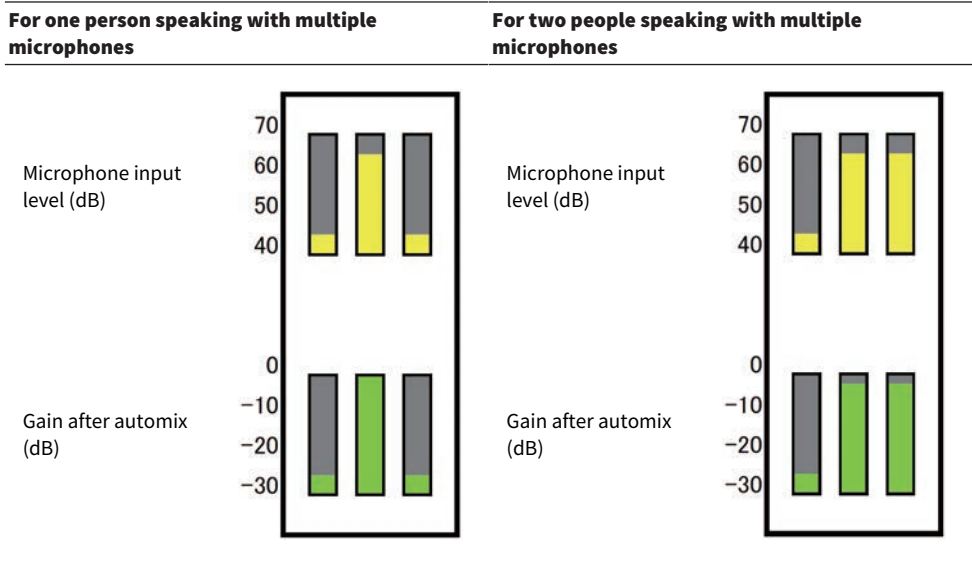

If one person speaks, that microphone's gain level will fade up instantly, while the gain for the other microphone will be reduced. If a different person speaks, the same behavior occurs.

If two people speak, the gain of two microphones will be automatically distributed so that the total gain will stay constant. The gain of the third microphone will be reduced.

The behavior of the Dugan Speech System is different than that of a limiter or auto-level controller function. This system allows an engineer to adjust the level balance as usual, even for multiple speakers. Also, while no one is speaking, the system detects the microphone input levels and automatically distributes the gain. This means that the faders can be left in a raised position.

Automixer distributes automix gain more preferentially to channels with higher input levels. Automixer provides the following benefits:

- It prevents unnecessary fluctuations of levels and uneven ambient noise that is input from microphones on the channels set to Channel Off or with a lowered fader setting

- It adjusts the gain and fader settings according to the speaker's voice level on each microphone, and inputs even signal levels, resulting in more accurate automix gain distribution.
- It achieves preferential distribution of automix gain for the speaker you want to emphasize by raising the fader for that speaker or lowering others.

AFC IMAGE control

AFC IMAGE settings

AFC IMAGE allows you to intuitively create a variety of effects without worrying about individual speaker settings, by arranging large numbers of objects and moving them freely. This can be done efficiently by controlling the AFC Image from the DM7 series.

- 1 Press the **SETUP** button on the menu bar to access the **SETUP** screen.**
- 2 Press the **NETWORK** button to display the **NETWORK** screen.**
This screen includes several pages, which you can switch among using the tabs located at the top of the screen.
- 3 Press the **IMMERSIVE SOUND** tab to display the **IMMERSIVE SOUND** screen.**

NOTE

Audio should be patched to the output card using DIRECT OUT or Output..

Other Operations

Storing a scene

The current mix data can be saved as new scene data, or overwritten onto existing scene data to update it.

1 Press the scene area.

The Scene List screen will appear.

2 Press the Store button.

The SCENE STORE screen is displayed, allowing you to assign a title or comment to the scene.

NOTE

- Press the Store button and the system automatically suggests a scene number and name (Automatic suggestion of scene numbers and names).
- To store with a decimal point, hold down the [SHIFT] key and press the Store button.

3 Enter a scene number as the store-destination.

4 Assign a title or comment to the scene as needed.

5 Press the Store button.

A dialog box is displayed asking you to confirm the store operation.

6 To execute the store operation, press the OK button.

The current mix data will be stored to the scene number you selected in step 2. If you decide to cancel the store operation, press the CANCEL button instead of the OK button.

NOTE

- You can configure a setting to prevent the store confirmation dialog box from appearing. (PREFERENCE screen)
- You cannot store data to a protected scene number.

Related links

“Scene List screen” (p.81)

Recalling a Scene

You can recall scene data into current memory. Scene data is recalled through two filters: Focus or Recall Safe.

1 Press the scene area.

The Scene List screen will appear.

2 Select the scene you want to recall.

If you recall any scene other than the last-recalled or stored scene (simply "current scene" below), the scene number will flash.

3 Press the Recall button.

A dialog box is displayed asking you to confirm the recall operation.

4 To execute the recall operation, press the OK button.

The scene you selected in step 2 will be recalled. To cancel the recall, press the CANCEL button.

NOTE

You can configure a setting to prevent the recall confirmation dialog box from appearing.

Temporary Recall Safe

If you recall a scene while holding down the [SEL] key of a channel, that channel will be temporarily placed into Recall Safe.

Related links

"Scene List screen" (p.81)

Deleting a Scene

This section explains how to delete a scene.

1 Press the scene area.

The Scene List screen will appear.

2 Rotate the screen encoder to select the scene you want to delete, and then press the Delete button.

A dialog box is displayed asking you to confirm the delete operation.

3 To execute the delete operation, press the OK button.

The scene number(s) you selected in step 2 will be erased. If you decide to cancel the delete operation, press the CANCEL button instead of the OK button.

NOTE

- You cannot delete protected scenes.
- To undo a scene deletion, press the Undo button.

Related links

“Scene List screen” (p.81)

Duplicating Scenes

You can duplicate a scene to create a new scene.

1 Press the scene area.

The Scene List screen will appear.

2 Rotate the screen encoder to select the scene you want to duplicate, and then press the Duplicate button.

The SCENE DUPLICATE screen will appear, allowing you to assign a title or comment to the scene.

3 Assign a title or comment to the scene as needed.

NOTE

You can store duplicated scenes to any desired scene number.

4 To execute the duplicate operation, press the Duplicate button.

The source scene will be duplicated and saved to the scene number specified in step 3. If you decide to cancel the duplicate operation, press the Cancel button instead of the Duplicate button.

Related links

“Scene List screen” (p.81)

Modifying the Scene Number and Title

This section explains how to modify the scene number and title.

1 Press the scene area.

The Scene List screen will appear.

2 Rotate the screen encoder to select the scene that you want to modify the number or title, and then press the scene title popup button.

The SCENE EDIT screen will appear, allowing you to assign a title or comment to the scene.

3 Modify the scene number and/or rename the scene, as needed.

4 To execute modify rename operation, press the OK button.

The changes you made in step 3 will be applied to the selected scene.

Related links

“Scene List screen” (p.81)

Using the Focus Function

The "Focus function" allows you to specify the scene parameters that will be recalled (loaded) when you recall a scene. This can be configured for each scene individually. For example, it can be convenient to use this function if you want to recall only the input channel settings of a certain scene.

NOTE

In contrast to the Focus function, the DM7 Series also features a "Recall safe" function that allows you to exclude specific channels and parameters from recall operations. However, while the Focus Recall function can be configured individually for each scene, the Recall Safe function settings are common to all scenes.

1 Press the scene area.

The Scene List screen will appear.

2 Press the Focus at the top of the Scene List screen.

The Focus field appears in the right half of the Scene List screen.

3 Press the Set button for the scene for which you want to configure Focus settings.

The FOCUS screen appears.

4 To select the channel you want to set, press the channel display button to display the channel, then scroll through the category selection list (channel).

5 If you want to apply the Focus function only to specific parameters, use the parameter setting button to turn the parameter to have Focus applied on (multiple selections are allowed). If you want to apply the Focus function to all parameters, turn on the All On button.

6 Turn on the channel Focus ON button for the channels to which you want to apply the Focus function.

If you want to apply the Focus function to all parameters, turn on the ALL channel Focus ON button.

7 When you finish configuring the settings, press the Apply button to apply the settings. Press the × button to close the window.

The Focus Parameter indicator on the Focus tab of the Scene List screen will Parametershow the Focus setting status of the scene for which the Focus function is configured.

NOTE

Scenes for which the Focus button is turned on are marked by a "Focus" indicator in the Status field of the Scene List window (Comment tab).

8 Recall a scene for which you have made Focus settings.

Only the channels/parameters selected in the FOCUS screen will be recalled.

NOTE

You can use the Focus function in conjunction with the Recall Safe function. Channels or parameters that are excluded from recall operations by either Focus or Recall Safe will not be recalled.

Related links

“Scene List screen (Focus)” (p.85)

Using the Fade Function

"Fade" is a function that smoothly changes the faders of specified channels/DCAs to their new values over a specified duration when you recall a scene. You can set the Fade function independently for each scene.

1 Press the scene area.

The Scene List screen will appear.

2 Press the Fade Time tab at the top of the Scene List screen.

The Fade Timefield will appear in the right half of the Scene List screen.

3 Press the Set button.

The FADE TIME screen appears.

4 In the channel select field, select the channels or DCAs to which the fade effect will be applied (multiple selections are allowed).

The [SEL] keys for the selected channels or DCAs will light, and those channels or DCAs will be highlighted green in the channel display field. You can cancel the selection by pressing the lit [SEL] key again to turn it off.

5 Use the screen encoder that corresponds to the Fade Time knob, or use the [TOUCH AND TURN] knob to adjust the fade time.

The range is 0.0 sec – 60.0 sec. When you finish setting, press the OK button to close the FADE TIME screen.

NOTE

The fade time you specify here is used for all channels/DCAs selected in step 4.

6 Press the Fade button to enable the Fade function.

You can turn the Fade function on/off individually for each scene.

NOTE

Scenes for which the Focus button is turned on are marked by a "Fade" indicator in the Status field of the Scene List window (Comment tab).

7 Recall a scene for which the Fade function is turned on.

The faders will begin to move immediately after Recall occurs, and will reach the values of the recalled scene over the course of the specified fade time.

NOTE

- By touching a moving fader, you can stop the fade operation of the fader at that point.
- If you recall the same scene while faders are moving, the faders of all channels and DCAs will move immediately to their target positions.

Related links

"Scene List screen (Fade Time)" (p.88)

Outputting a Control Signal to an External Device in Tandem with Scene Recall (GPI OUT)

A control signal can be output to an external device connected to the GPI connector when you recall a specific scene. Proceed as follows.

NOTE

For more information about GPI Out settings, refer to "Using GPI Out".

1 Press the scene area.

The Scene List screen will appear.

2 Press the "GPI" tab at the top of the Scene List screen.

The GPI Out field appears in the right half of the Scene List screen.

3 For each scene, specify the control signal that you want to output to each GPI Out port.

Pressing a button repeatedly will switch between the following functions.

- ---- **(OFF)** Nothing will be output.
- **TRIGGER**A trigger will be output when the scene is recalled.
- **TALLY**A tally will be output when the scene is recalled.

4 Press the GPI button to enable the GPI Out function.

You can turn the GPI Out function on/off individually for each scene.

NOTE

Scenes for which the GPI button is turned on are marked by a "GPI" indicator in the Status field of the Scene List window (Comment tab).

5 Recall the scene for which you want to output GPI Out signals.

When you recall the scene, the control signals will be output to an external device connected to the GPI connector.

Related links

"Scene List screen (GPI)" (p.91)

Using the Global Paste Function

"Global Paste" is a function that allows you to copy-and-paste the settings of a desired channel or parameter to scene data in memory. This is a convenient way in which changes can be applied to multiple scenes that have already been stored.

1 Press the scene area.

The Scene List screen will appear.

2 Press the Global Paste tab at the top of the Scene List screen.

The Global Paste screen appears.

3 Select the scene group being pasted into the Destination Scene field.

Select the scene(s) to store the scene group.

4 Select the copy-source channels/parameters in the Parameter field.

Press the Manual button to display the GLOBAL PASTE PARAMETERS screen. On this screen, select the channel and parameter to be copied from. When you finish making settings, press the X symbol to return to the Global Paste screen.

5 Press the Paste button.

The selected item(s) will be pasted to the scene(s) in the selected scene group. A progress bar will appear during the paste operation. Also, during the paste operation, a Cancel button will appear, which you can press to cancel the paste operation. In this case, data will be pasted up until you press the STOP button. The operation cannot be reverted.

NOTE

- In any of the following cases, a dialog box will appear and data will not be pasted:
 - You attempted to paste data to a protected scene.
 - The paste destination scene has been deleted by another operation (from DM7 Editor, etc.) just before the paste operation was executed.
- If pasting data to one of the paired channels causes the pairing setting to be canceled, the other channel from that pair will be set to MONO.

Related links

"Global Paste screen" (p.97)

Using the Recall Safe Function

"Recall Safe" is a function that excludes only specific parameters/channels (DCAs) from Recall operations. Unlike the Focus function which lets you make settings for individual scenes, the Recall Safe settings are globally applied to all scenes.

1 Press the scene area.

The Scene List screen will appear.

2 Press the Recall Safe tab.

The RECALL SAFE screen appears.

3 To select the channel you want to set, press the channel display button to display the channel, then scroll through the category selection list (channel).

4 If you want to apply the Recall Safe function only to specific parameters, use the parameter buttons to select those parameters (multiple selections are allowed). If you want to apply the Recall Safe function to all parameters, turn on the All On button.

5 Turn on the channel Recall Safe ON button for the channels to which you want to apply the Recall Safe function.

If you want to apply the Recall Safe function to all parameters, turn on the ALL channel Recall Safe ON button.

NOTE

You can use the Recall Safe function in conjunction with the Focus function. Channels or parameters that are excluded from recall operations by either Focus or Recall Safe will not be recalled.

Related links

"Recall Safe screen" (p.95)

Saving Settings Data on a USB Drive

All internal data can be saved to the USB drive in a single operation as a settings file. The extension of the saved file is ".dm7f".

1 Press the Save/Load button in the Utility screen to access the Save/Load popup window.

2 Press the Save button.

The SAVE screen will appear, in which you can select data to save.

3 This allows you to select the type of data to save.

NOTE

The Save button will become available if data to save exists.

4 Press the Save button in the SAVE screen.

A window will appear, allowing you to enter a file name and comment.

5 Enter a file name or comment, and press the Save button.

When the file has been saved, the PROCESSING window that shows the progress of the writing operation will close.

NOTE

- If you are going to overwrite a file or save a file with the same name in the same folder, a dialog will ask you to confirm the overwrite.
- You can enter a comment of up to 54 characters.
- You may enter a file name of up to 16 characters. However, the drive name, path name, and file name are limited to a total of 256 characters. If you exceed this limit, you may be unable to save the file, depending on the length of the file name. If this error indication appears at the bottom of the screen, shorten the file name and try saving the file again.

Related links

“SAVE/LOAD screen” (p.299)

Loading a File from a USB Drive

Follow the steps below to load the setting file from the USB drive into the console. You can use the same procedure to load the following files other than the setting file.

Extension	Contents of file
.dm7f	All data including internal settings
.BMP	Image file for display in the CONSOLE LOCK screen (256 or more colors, uncompressed bitmap format)
.jpg	Image file for display in the CONSOLE LOCK screen (JPEG format)
.png	Image file for display in the CONSOLE LOCK screen (PNG format)

NOTICE

- Some data may contain settings that will cause the console to output signals immediately after the data is loaded. Therefore, before loading data, turn off the power to the connected equipment and/or lower the volume of such equipment so that there will not be a problem even if a signal is output.

1 Press the Save/Load button in the Utility screen to access the Save/Load popup window.

Select a file to load.

NOTE

The Load button will become available if you select loadable data.

2 Press the Load button.

The LOAD screen will appear, in which you can select data to load.

3 In the LOAD screen, select a type of data and data to load.

4 Press the Load button. A confirmation dialog box will appear.

5 Press the OK button to begin loading the data.

When the file has finished loading, the PROCESSING window that shows the progress of the loading operation will close.

NOTE

Setting files that have been saved in Split mode can only be loaded on consoles in Split mode that have the same Mix bus configuration.

Related links

“SAVE/LOAD screen” (p.299)

Editing a File

Copying and pasting

Follow the steps below to copy a file into buffer memory, and then paste it with a different file name.

- 1 Check the check box of the file being copied.**
- 2 Press the Copy button that appears at the bottom.**
- 3 If necessary, press the directory icon and change the directory.**
To move to the next higher level, press the arrow button in the Path field.
NOTE
Copying between different storage (internal to external, etc.) is also possible.
- 4 Press the Paste button.**

Deleting

- 1 Check the check box of the file being deleted.**
- 2 Press the Delete button that appears at the bottom.**
A dialog box will ask you to confirm the Delete operation.
- 3 To execute the delete operation, press the OK button.**

NOTE

You cannot delete a file that has been protected by pressing the Lock button.

Related links

“SAVE/LOAD screen” (p.299)

Creating a Directory

- 1 If necessary, press the directory icon and change the directory.**
To move to the next higher level, press the arrow button in the Path field.
- 2 Press the Menu button, then press the Make Dir button that appears.**
- 3 Enter the name of the directory you want to create, then press the Save button.**

NOTE

You cannot create a directory using a directory name that already exists.

Related links

“SAVE/LOAD screen” (p.299)

Using the Monitor Function

Controlling the Monitor function via the MONITOR screen

In this screen, you can select desired monitor sources to monitor them from the PHONES output jacks or external monitor speakers.

1 Connect your monitor system to the OMNI OUT jacks, etc. on the rear panel.

Monitor signals can be sent to any desired output jack or output channel. If you are monitoring through headphones, make sure that your headphones are connected to the front panel PHONES output jacks.

2 Press the Monitor button on the menu bar.

The MONITOR screen appears. The Monitor field on the MONITOR screen allows you to check the current monitoring settings, and turn monitoring on/off.

3 Press the MONITOR button.

The MONITOR settings window appears. In the MONITOR settings window you can make detailed monitoring settings.

4 Press the Monitor Source Define button to open the MONITOR SOURCE DEFINE popup window, then select the monitor sources.

You can assign up to 8 channel signals to each DEFINE. Pressing the Clear All button will clear all selections. You can choose from the following monitor sources.

5 Use the Source Select buttons to select monitor sources.

6 To specify a port as the output destination for monitor signals L, R, and C, press one of the Output Patch buttons (L/R/C) on the MONITOR settings window to open the Output Patch window. In this window, choose from the following monitor signal output destinations (multiple selections are allowed).

When you have selected an output port, press the CLOSE button to close the popup window. In the same way, specify the output ports for monitor signals L, R, and C.

NOTE

If desired, you can specify output ports only for monitor signals L and R to monitor through two speakers.

7 To enable the monitor, press the Output button to turn it on.

The monitor source you selected in step 4 will be sent to the output destination you specified in step 6.

NOTE

The PHONES output jacks will always output the monitor signal, regardless of whether the MONITOR OUTPUT button is on/off.

8 Adjusts the monitor level with the monitor fader.

If Phones Level Link is ON, use the PHONES LEVEL knob to adjust the monitor level when monitoring through headphones.

9 Make settings for Dimmer, Delay, Monaural, and Cue Interruption as desired.

NOTE

Monitor on/off operations, selection of the monitor source, and dimmer on/off operations can also be assigned to USER DEFINED keys.

Related links

“MONITOR(MONITOR) Screen” (p.226)

Using the Cue Function

This section explains how to use the [CUE] key of a desired channel or DCA to monitor the Cue signal.

NOTE

Be aware that if you turn Cue Interrupt off in the PHONES window, the cue signal will not be sent to the connected monitor speakers. However, the PHONES output jacks on the front panel will always output cue signals regardless of the Monitor on/off setting. For details on the Monitor function settings, refer to Using the Monitor function.

1 Press the Monitor button on the menu bar.

The MONITOR screen appears. The CUE field on the MONITOR screen allows you to check the current cue settings, and turn Cue on/off.

2 Press the CUE button.

The CUE screen appears. You can select the cue destination (CUE A, CUE B, or A+B).

3 Select either the mode in which channels are mixed for monitoring, or the mode in which only the last-selected channel is monitored in the Mode section.

Select the Mix CUE button or Last CUE button.

NOTE

In Mix CUE mode, it is not possible to simultaneously turn on Cue for different Cue groups. The Cue group to which the last-cued signal belongs will be turned on, allowing only the signals of that Cue group to be monitored.

4 Use the buttons and knobs of the Input field, DCA field, and Output field to specify the output position and output level for each Cue group.

Refer to the explanation for each item on the CUE screen, and make the desired settings.

5 To specify a port as the output destination for cue signals L and R, press one of the Output Patch buttons (L/R).

The patch selection window appears. Choose from the following cue signal output destinations (multiple selections are allowed).

6 To enable Cue Out for the ports you specified in step 5, press the Output button to turn it on.

7 Press the [CUE] key of a desired channel or DCA to turn it on.

The cue signal of the corresponding channel will be sent to the output destination specified in step 5, and also to the monitor output. You can also view the Cue meter in the meter area to check the output level of the cue signal.

NOTE

- When using the MIX/MATRIX bus select buttons in the SENDS ON FADER window, you can press the selected button once again to turn on Cue for the corresponding MIX/MATRIX channel.
- If you want cue operations and channel select operations to be linked, open the SETUP window, choose the "PREFERENCE screen" (p.110), and then turn on "[CUE]→[SEL] LINK".

8 If you are auditioning the cue signal in the monitor, adjust the cue signal level with the fader Level.

If Phones Level Link is ON, you can use the fader Level and the PHONES LEVEL knob to adjust the cue signal level while monitoring through headphones.

NOTE

To adjust the level of the signal sent to the Cue Out port (which you specified in step 6), use the output port Level for the patch destination.

9 To cancel the cue, press the currently-on [CUE] key once again.

You can press the Clear CUE button in the CUE popup window to clear all cue selections.

NOTE

- If you press the cue meter in the meter area, all cue selections will be cleared.
- All cue selections will be cleared if you switch between Mix CUE mode and Last CUE mode in the Mode section.
- You can also assign the function of the Clear CUE button to a USER DEFINED key (see “The Functions that can be Assigned to User Defined Keys” (p.400)).

Related links

“MONITOR (CUE) screen” (p.232)

Using the Solo Function

This function allows you to monitor the signals routed from one or more specified channels to the main mix outputs.

1 Press the Monitor button on the menu bar.

The MONITOR screen appears. The CUE field on the MONITOR screen allows you to check the current cue settings, and turn Cue on/off.

2 Press the CUE button.

The CUE screen appears.

3 Select either the mode in which channels are mixed for monitoring, or the mode in which only the last-selected channel is monitored in the Mode section.

Select the Mix CUE button or Last CUE button.

4 Press the SOLO ON button to turn Solo on.

The confirmation window for solo operation appears.

5 To execute the solo operation, press the OK button.

The button will light up and SOLO mode will be enabled.

6 If you want to exclude certain channels or groups from Solo operations, press the SOLO Safe button.

The SOLO SAFE screen appears.

7 Select input channels that will be excluded from SOLO operations (multiple selections are allowed).

The channels specified here will not be muted in SOLO mode. The Solo Safe function is useful if you do not want to accidentally mute certain channels during Solo operations, such as the main STEREO channels, or MIX channels that send out mix signals to an external recorder.

8 Press the [CUE] key of a desired channel or DCA to turn it on.

Only the corresponding channel or DCA will be output to the buses and output jacks; other channels and DCAs will be muted. The same signal will also be output from the CUE OUT jacks and the MONITOR OUT jacks.

NOTE

If you turn on the [CUE] key of an output channel, the signal will be sent only to the corresponding bus.

9 To cancel Solo, press the currently-on SOLO ON button once again.

NOTE

If you select the Last CUE button to switch from Last CUE mode to Mix CUE mode (or vice versa), all previously-enabled Cue (Solo) signals will be canceled.

Using the Oscillators

Sends a sine wave or pink noise from the internal oscillator to any chosen bus.

1 Press the Monitor button on the menu bar.

The MONITOR screen appears. The OSCILLATOR field in the MONITOR screen lets you check the current oscillator settings, and turn the oscillator on/off.

If you want to view or edit the oscillator settings in greater detail, use the OSCILLATOR popup window described in step 2 and subsequent steps.

2 Press the OSCILLATOR button.

The OSCILLATOR window appears. In this window, you can make detailed settings for the oscillator.

3 Press the Mode button to select the type of signal you want to output.

4 Use the parameter field to adjust the oscillator parameters.

The displayed parameters will vary depending on the oscillator selected with the Mode button. To control the value shown in the parameter field, either use the [TOUCH AND TURN] knob or touch the screen to slide it vertically or horizontally.

5 Press a button in the Assign field to specify the input channel(s) or bus(es) to which the oscillator signal will be sent (multiple selections are allowed).

6 To enable the oscillator, press the Output button to turn it on.

The oscillator signal will be sent to the input channel or bus you selected in step 5. Press this again to turn oscillator off.

NOTE

You can also assign oscillator on/off or an ASSIGN change to a USER DEFINED key.

Related links

“MONITOR (OSCILLATOR) screen” (p.240)

Using Talkback

The Talkback function sends the signal (that is input at the input ports) to the desired bus.

1 Press the Monitor button on the menu bar.

The MONITOR screen appears. In the MONITOR screen, the TALKBACK field allows you to check the current talkback settings, and turn talkback on/off.

If you want to view or edit the talkback settings in greater detail, use the TALKBACK window described in step 2 and following.

2 Press the TALKBACK popup button.

The TALKBACK window appears. In this popup window, you can make detailed settings for talkback.

3 If you want to use an input jack as supplementary input for talkback, follow the steps below.

1 Press the Input TO TB patch button to display the patch selection window.

2 Select the input that you want to use for talkback from the buttons. You can select only one input at a time.

3 Use the gain knob and level meter in the Input TO TB field to adjust the input level of the connected mic.

NOTE

The PAD will be switched on/off internally when the HA gain is adjusted between -1 dB and 0 dB. Keep in mind that noise may be generated when using phantom power if there is a difference between the Hot and Cold output impedance of an external device connected to the INPUT jack.

4 Select the bus(es) as the talkback signal destination in the Assign field or output jack(s) in the Talkback Output field (multiple selections are allowed).

5 To enable talkback, press the Talkback ON button to turn it on.

The Talkback ON button will alternately turn on/off each time you press the button (Latch operation). While talkback is on, signals from the TALKBACK jack and the selected INPUT jack will be output to the destination buses.

NOTE

- You can also assign talkback on/off or an Assign change to a USER DEFINED key. In this case, you can select either a Latch operation or an Unlatch operation (the function will be enabled only while you continue holding down the key).
- You can also use the Dimmer on TB function to attenuate the monitor level of the non-talkback signals while talkback is on .

Related links

“TALKBACK screen” (p.245)

Using PHONES

- 1 Press the Monitor button on the menu bar.**
The MONITOR screen appears.
- 2 Press the PHONES button.**
The PHONES screen appears.
- 3 Use the buttons on screen to make PHONES settings.**
- 4 When you finish making settings, press the × symbol.**

Related links

“PHONES screen” (p.237)

About Meter Area

The meter area displays various meters. Press any part of the meter area to recall the corresponding fader layer to the panel.

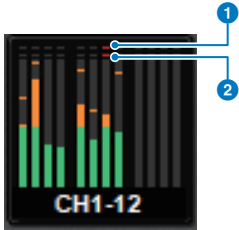

1 Σ clipping indicator

Lights to indicate that a signal is clipping at some point in the channel.

2 OVER indicator

Lights to indicate that a signal is clipping at the metering point in the channel.

NOTE

Switch the metering point in the Metering Point field(“Controlling the METER Screen” (p.389)).

You can switch the meter area display on the screen that appears when you press the button



of the menu bar.

Meter Full Screen button

The METER screen (FULL SCREEN) is displayed.

Controlling the METER Screen

You can recall the METER screen (Meter Full Screen) to display the input and output levels of all channels on the screen or switch the metering points of the level meters (the points where the level is detected).

Tabs

Switches between the Input METER screen, Output METER screen, and DCA METER screen.

Input METER screen

The meters, faders, and ON buttons of the input channels are displayed.

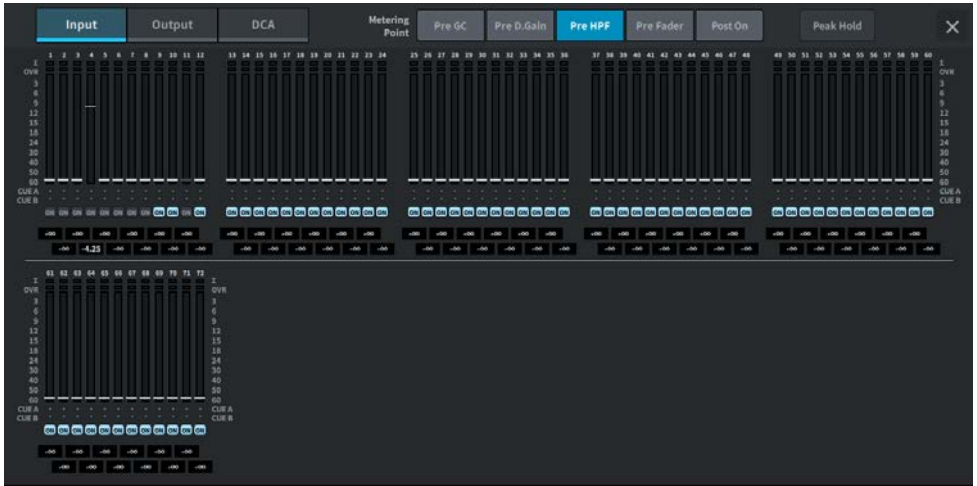

Output METER screen

All output channels, STEREO A/B, CUE A/B, and MONITOR A/B meters are displayed.

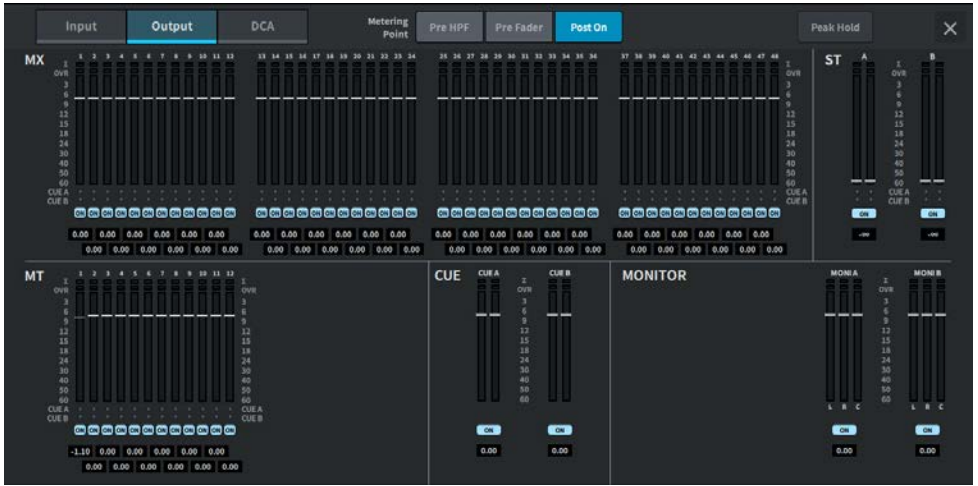

DCA METER screen

The DCA meters are displayed.

Fader level/meter display

The meters and faders of each channel are displayed.

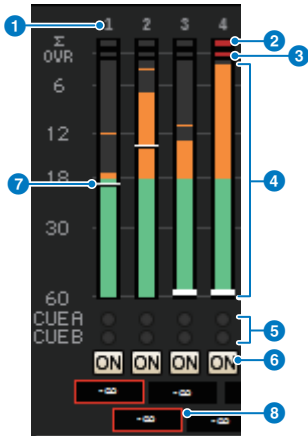

1 Channel number

The channel numbers are displayed.

2 Σ clipping indicator

Lights to indicate that a signal is clipping at some point in the channel.

3 OVER indicator

Lights to indicate that a signal is clipping at the metering point in the channel.

4 Meter

The input or output levels of the channels are displayed. Press to switch to fader banks.

5 CUE A/B indicators

The CUE statuses are displayed.

6 ON indicators

The on/off statuses of the channels are displayed. Press to switch on/off.

7 Fader

The levels of the channels at the fader positions are displayed. If the [ON] key of the channel is turned OFF, the fader will turn gray.

8 Fader value/channel name display

The levels of the channels are displayed numerically (dB).

NOTE

Touch (or click) the fader bank for each of the 12 channels to recall the corresponding fader layers on the panel.

Metering Point field

Select the metering points detecting the levels from the following. The metering points of the level meters can be individually set for input channels and output channels.

■ Input METER

- Pre GC
- Pre D. Gain
- Pre HPF
- Pre Fader
- Post On

Pre GC is enabled when there is GC for the device that has been input patched. For channels with no GC, the Pre D. Gain meter value is displayed for the Pre GC metering point.

■ Output METER

- Pre HPF
- Pre Fader
- Post On

Peak Hold button

If this button is on, the peak of each meter is held. If the button is off, the peaks are cleared. Whether the Peak Hold button is on/off affects both the input and output channels. If this button is off, the displays of all held peak levels are cleared.

NOTE

On/off switching of the Peak Hold button can be assigned to a User Defined key.

Assigning a Function to a User Defined Knob

- 1 Press the Setup button on the menu bar.**
- 2 Press the User Setup button to access the USER SETUP screen.**
- 3 Press the User Defined Knobs / Encoder Mode button.**

The USER DEFINED KNOBS window appears.
- 4 Press the button corresponding to the User Defined knob to which you want to assign a function.**

The system displays a popup window, in which you can assign a function to the User Defined knob.
- 5 Check the Function field, and then use the screen encoder on the panel to select the function you want to assign.**

For details on the assignable functions and their parameters, refer to the appendix.
- 6 If the selected function features parameters, specify the type of parameter you want to assign by selecting in the following order: Parameter 1 field -> Parameter 2 field -> Parameter 3 field.**
- 7 Press the OK button to close the popup window.**
- 8 Assign the desired functions to other User Defined knobs in the same way.**

Related links

“USER DEFINED KNOBS screen” (p.115)

The Functions that can be Assigned to User Defined Knobs

The functions that can be assigned to User Defined knobs are as follows.

Function	Parameter1	Parameter2	Parameter3
No Assign	---	---	---
Input Gain	Analog Gain	Selected Ch	Bay L, Bay C
		CH 1-120	---
	Digital Gain	Selected Ch	Bay L, Bay C
		CH 1-120	---
TO STEREO	Pan/Bal	Selected Ch	Bay L, Bay C
		CH 1-120, MX1-48	---
	CSR	Selected Ch	Bay L, Bay C
		CH 1-120	---
TO MX Level	MX 1-48	Selected Ch	Bay L, Bay C
		CH 1-120	---
TO MT Level	MT 1-12	Selected Ch	Bay L, Bay C
		CH 1-120, MX1-48, STA, ST B	---
TO MX Pan/Bal	MX 1-48	Selected Ch	Bay L, Bay C
		CH 1-120	---
TO MT Pan/Bal	MT 1-12	Selected Ch	Bay L, Bay C
		CH 1-120, MX1-48, STA, ST B	---
	Threshold	Selected Ch	Bay L, Bay C
		CH 1-120, MX1-48, STA, ST B	---
	Range	Selected Ch	Bay L, Bay C
		CH 1-120, MX1-48, STA, ST B	---
DYN 1	Ratio	Selected Ch	Bay L, Bay C
		CH 1-120, MX1-48, STA, ST B	---
	Frequency	Selected Ch	Bay L, Bay C
		CH 1-120, MX1-48, STA, ST B	---
	Attack	Selected Ch	Bay L, Bay C
		CH 1-120, MX1-48, STA, ST B	---

Other Operations > The Functions that can be Assigned to User Defined Knobs

Function	Parameter1	Parameter2	Parameter3
DYN 1	Hold	Selected Ch	Bay L, Bay C
		CH 1-120, MX1-48, STA, ST B	---
	Decay	Selected Ch	Bay L, Bay C
		CH 1-120, MX1-48, STA, ST B	---
	Release	Selected Ch	Bay L, Bay C
		CH 1-120, MX1-48, STA, ST B	---
	OutGain	Selected Ch	Bay L, Bay C
		CH 1-120, MX1-48, STA, ST B	---
	Knee	Selected Ch	Bay L, Bay C
		CH 1-120, MX1-48, STA, ST B	---
	Type	Selected Ch	Bay L, Bay C
		CH 1-120, MX1-48, STA, ST B	---
	Q	Selected Ch	Bay L, Bay C
		CH 1-120, MX1-48, STA, ST B	---
	Input	Selected Ch	Bay L, Bay C
		MX1-48, STA, ST B	---
Output	Selected Ch	Bay L, Bay C	
	MX1-48, STA, ST B	---	
Recovery	Selected Ch	Bay L, Bay C	
	MX1-48, STA, ST B	---	
Mix Balance	Selected Ch	Bay L, Bay C	
	CH 1-120, MX1-48, STA, ST B	---	
DYN 2	Threshold	Selected Ch	Bay L, Bay C
		CH 1-120	---
	Range	Selected Ch	Bay L, Bay C
		CH 1-120	---
	Ratio	Selected Ch	Bay L, Bay C
		CH 1-120	---
	Frequency	Selected Ch	Bay L, Bay C
		CH 1-120	---
	Attack	Selected Ch	Bay L, Bay C

Other Operations > The Functions that can be Assigned to User Defined Knobs

Function	Parameter1	Parameter2	Parameter3
DYN 2	Attack	CH 1–120	---
	Hold	Selected Ch	Bay L, Bay C
		CH 1–120	---
	Decay	Selected Ch	Bay L, Bay C
		CH 1–120	---
	Release	Selected Ch	Bay L, Bay C
		CH 1–120	---
	OutGain	Selected Ch	Bay L, Bay C
		CH 1–120	---
	Knee	Selected Ch	Bay L, Bay C
		CH 1–120	---
	Type	Selected Ch	Bay L, Bay C
		CH 1–120	---
	Q	Selected Ch	Bay L, Bay C
		CH 1–120	---
	Input	Selected Ch	Bay L, Bay C
CH 1–120		---	
Output	Selected Ch	Bay L, Bay C	
	CH 1–120	---	
Recovery	Selected Ch	Bay L, Bay C	
	CH 1–120	---	
Mix Balance	Selected Ch	Bay L, Bay C	
	CH 1–120	---	
Delay	Delay Time	Selected Ch	Bay L, Bay C
		CH 1–120, MX 1–48, MT 1–12, STA, ST B	---
EQ	Band1–8 Q	Selected Ch	Bay L, Bay C
		CH 1–120(Band1-4), MX 1–48, MT 1–12, STA, ST B	---
	Band1–8 Frequency	Selected Ch	Bay L, Bay C
		CH 1–120(Band1-4), MX 1–48, MT 1–12, STA, ST B	---
Band1–8 Gain	Selected Ch	Bay L, Bay C	
	CH 1–120(Band1-4), MX 1–48, MT 1–12, STA, ST B	---	
Filter	HPF Freq	Selected Ch	Bay L, Bay C
		CH 1–120, MX 1–48, MT 1–12, STA, ST B	---

Other Operations > The Functions that can be Assigned to User Defined Knobs

Function	Parameter1	Parameter2	Parameter3
Filter	LPF Freq	Selected Ch	Bay L, Bay C
		CH 1-120, MX 1-48, MT 1-12, STA, ST B	---
Ch Fader	Specific Ch	CH	CH 1-120
		MX	MX 1-48
		MT	MT 1-12
		ST	ST A-B
		DCA	DCA 1-24
Brightness*	Light		---
	Mini LCD		---
	Color Bar		---
	Panel		---
	Screen		---
CUE	CUE A	Input PFL Trim	---
		DCA Trim	---
		Output PFL Trim	---
		CUE Level	---
	CUE B	Input PFL Trim	---
		DCA Trim	---
		Output PFL Trim	---
		CUE Level	---
Monitor	Common	Dimmer Level	---
		TB Dimmer Level	---
	Monitor A	Delay	---
		Fader	---
	Monitor B	Delay	---
		Fader	---
	Surround Monitor	Dimmer Level	---
		TB Dimmer Level	---
Oscillator	Level		---
	Sine2 Level		---
	Sine1 Frequency		---
	Sine2 Frequency		---
Automixer	Weight	Automixer CH 1-64	---
DAW Remote	Control Room	Level	---
	Phones	Level	---

Other Operations > The Functions that can be Assigned to User Defined Knobs

* Cannot be assigned to a User Defined knob in DM7 Editor.

Assigning a Function to a User Defined Key

- 1 Press the Setup button on the menu bar.**
- 2 Press the User Setup button to access the USER SETUP screen.**
- 3 Press the User Defined Keys button.**
The USER DEFINED KEYS window appears.
- 4 Press the button corresponding to the User Defined key to which you want to assign a function.**
The system displays a popup window, in which you can assign a function to the User Defined key.
- 5 Check the Function field, and then use the screen encoder on the panel to select the function you want to assign.**
For details on the assignable functions and their parameters, refer to the appendix.
- 6 If the selected function features parameters, specify the type of parameter you want to assign by selecting in the following order: Parameter 1 field -> Parameter 2 field -> Parameter 3 field.**
- 7 Press the OK button to close the assignment window.**
- 8 Assign the desired functions to other User Defined keys in the same way.**

Related links

“USER DEFINED KEYS Screen” (p.118)

The Functions that can be Assigned to User Defined Keys

The functions that can be assigned to User Defined keys are as follows.

Function	Parameter1	Parameter2	Parameter3	Description
No Assign	---	---	---	No assignment
Alternate Function	Latch			Toggles the Alternate Function each time this is pressed.
	Unlatch			Switches to the Alternate Function only when this is pressed.
Automixer	Group A,B,C,D,E Override On			Switches the Override of each group on/off.
	Group A,B,C,D,E Preset On			Switches the Preset of each group on/off.
Brightness	Bank Select	A		Selects the Brightness setting Bank.
		B		
CH ON	Specific CH	CH	1-120	Switches the channel on/off.
		MX	1-48	
		MATRIX	1-12	
		STEREO	A, B	
		DCA	1-24	
CH Select	Inc			Switches the channel being controlled in the Selected Channel section to the next channel.
	Dec			Switches the channel being controlled in the Selected Channel section to the previous channel.

Other Operations > The Functions that can be Assigned to User Defined Keys

Function	Parameter1	Parameter2	Parameter3	Description
CH Select	Specific CH	CH	1-120	Switches the channel being controlled in the Selected Channel section to the channel specified in the list.
		MX	1-48	
		MATRIX	1-12	
		STEREO A	L, R	
		STEREO B	L, R	
CUE	Output	A		Switches CUE A on/off.
		B		Switches CUE B on/off.
	Clear CUE	CUE A		Clears CUE A.
		CUE B		Clears CUE B.
		CUE A+B		Clears CUE A+B.
	Specific CH	CH	1-120	Switches Cue Out on/off.
		MX	1-48	
		MATRIX	1-12	
		STEREO	A, B	
		DCA	1-24	
	CUE Mode	A, B		Switches the cue mode.
	CUE Interruption	Monitor A, Monitor B		Switches the CUE Interruption function on/off.
	Input CUE Point	A, B		Switch the cue point of the input channel.
	DCA CUE Point	A, B		Switches the cue point of the output channel.
Output CUE Point	A, B		Switches the cue point of the DCA.	
Fader CUE Release	ON		Switches Fader CUE Release on/off.	
Backstop PFL	ON		Switches Backstop PFL on/off.	
DAW Remote	Transport	Go to Project Start		Control the transport functions of your DAW.
		Go to Prev Marker		
		Rewind		
		Fast Forward		
		Go to Next Marker		
		Go to Project End		

Other Operations > The Functions that can be Assigned to User Defined Keys

Function	Parameter1	Parameter2	Parameter3	Description
DAW Remote	Transport	Cycle		Control the transport functions of your DAW.
		Stop		
		Play		
		Rec		
	Jog Wheel	Scrub		Turns the Jog Wheel's scrub mode on/off.
		Shuttle		Turns the Jog Wheel's shuttle mode on/off.
	Automation	Touch		Configure Automation mode settings.
		Auto Latch		
		Cross Over		
		Trim		
		Read All		
		Write All		
	Fader Bank	Ch Left		Moves the channel assigned to the fader left or right in 1-channel units.
		Ch Right		
		Bank Left		Moves the channel assigned to the fader left or right in 12-channel units. (12-channel units for DM7 Compact, 12-channel units for DM7 when Bay Link is disabled, 24-channel units when Bay Link is enabled)
		Bank Right		
Rec Ready All			All tracks ready to record.	
Clear Mute			Unmutes all.	
Clear Solo			Clears all solos.	
DM7 CONTROL	Jog Wheel	Target	DAW	Selects the DAW as the Jog Wheel target.
			Scene List	Selects the Scene List as the Jog Wheel target.

Other Operations > The Functions that can be Assigned to User Defined Keys

Function	Parameter1	Parameter2	Parameter3	Description
DM7 CONTROL	Jog Wheel	Target	Touch and Turn	Selects Touch and Turn as the Jog Wheel target.
Effect Bypass	FX Rack 1-16			Puts Effects in a bypass state.
Fader Bank Select	This Bay	CH	1-12, 13-24, 25-36, 37-48, 49-60, 61-72, 73-84, 84-96, 97-108, 109-120	Selects the current Bay's fader bank.
		MX	1-12, 13-24, 25-36, 37-48	
		MATRIX	1-12	
		ST/MON		
		DCA	1-12, 13-24	
		CUSTOM	1A-4E	
		DAW	1-12, 13-24	
	Bay C	CH	1-12, 13-24, 25-36, 37-48, 49-60, 61-72, 73-84, 84-96, 97-108, 109-120	Selects Bay C's fader bank.
		MX	1-12, 13-24, 25-36, 37-48	
		MATRIX	1-12	
		ST/MON		
		DCA	1-12, 13-24	
		CUSTOM	1A-4E	
		DAW	1-12, 13-24	
	Bay L	CH	1-12, 13-24, 25-36, 37-48, 49-60, 61-72, 73-84, 84-96, 97-108, 109-120	Selects Bay L's fader bank.
		MX	1-12, 13-24, 25-36, 37-48	
		MATRIX	1-12	
		ST/MON		
		DCA	1-12, 13-24	
		CUSTOM	1A-4E	
		DAW	1-12, 13-24	

Other Operations > The Functions that can be Assigned to User Defined Keys

Function	Parameter1	Parameter2	Parameter3	Description
Fader Bank Snapshot	This Bay, Bay L, Bay C, Bay All			Stores the current fader layer and position for each bay (when the key is pressed for 2 seconds or longer). Or, returns to the last stored layer and position (when the key is pressed for under 2 seconds).
GEQ FREQ Bank	INC	This Bay, Bay L, Bay C		Use the faders in the Channel Strip section on the GEQ EDIT screen to change the bands that will be controlled.
	DEC	This Bay, Bay L, Bay C		
Global Paste	All IN ONE	Group 1–32, Current Scene, All Scenes	W/ Screen W/O Screen	Executes Global Paste in a single operation.
		No Scene	-	Current Scene selects the lowest scene group to which the current scene belongs. No Scene clears the selected scene group.
	Set by Edit	Group 1–32, Current Scene, All Scenes	W/ Screen W/O Screen	Switches the Set by Edit function on/off.
		Paste	-	Executes Global Paste.
GPI Out	1–10	Latch		Switches the GPI OUT function on/off.
		Unlatch		Turns the GPI OUT function on only when this is pressed.
Input A/B	Specific CH	CH 1–120		Switches the specified channel's input patch A/B.
Live Rec	Transport	Go To Project Start		Operates the transport function of the DAW.
		Go To Prev Marker		

Other Operations > The Functions that can be Assigned to User Defined Keys

Function	Parameter1	Parameter2	Parameter3	Description
Live Rec	Transport	Rewind		Operates the transport function of the DAW.
		Fast Forward		
		Go To Next Marker		
		Go To Project End		
		Cycle		
		Stop		
		Start		
		Rec		
	Easy Recording			
	Add Marker			Executes Add Marker in Nuendo Live.
Meter	Peak Hold			Turns peak hold for meters on/off.
MIDI	Program Change On	Tx, Rx	Local PY	Turns Program Change messages on/off.
	Program Change	PGM 1–128		Sends the program change message with the corresponding number to the external device.
	Control Change On	Tx, Rx	Local PY	Turns Control Change on/off.
	Control Change	CC 1–31, 33–95, 102–119		Sends the control change with the corresponding number to the external device.
	Note On	NOTE ON C-2(0)–G8(127)		Send the corresponding MIDI message to the external device.
Monitor	Common	Dimmer On		Switches the Dimmer on/off.
	Monitor A	Output		Switches Monitor A on/off.

Other Operations > The Functions that can be Assigned to User Defined Keys

Function	Parameter1	Parameter2	Parameter3	Description
Monitor	Monitor A	Source Select/Sel Ch Assign	Define 1-8	Pressing this key selects DEFINE. Pressing the [SEL] key while this key is being pressed switches Assign on/off. The [SEL] LED is lit up when Assign is ON and dark when it is OFF.
		Dimmer ON		Attenuates Monitor A's monitor signal.
		Source Select Mode		Toggles Monitor A's Source Select Mode.
		Mono		Sets Monitor A's output mode to monaural.
		Speaker Select	MAIN	Selects Monitor A's output destination Speaker.
	ALT1			
	ALT2			
	Monitor B	Output		Switches Monitor B on/off.
		Source Select/Sel Ch Assign	Define 1-8	Pressing this key selects DEFINE. Pressing the [SEL] key while this key is being pressed switches Assign on/off. The [SEL] LED is lit up when Assign is ON and dark when it is OFF.
		Dimmer ON		Attenuates Monitor B's monitor signal.
Source Select Mode		Toggles Monitor B's Source Select Mode.		
Mono		Sets Monitor B's output mode to monaural.		
Mute Group Control	Mute 1-12	On	Toggles Mute Group Control on/off.	
	All Mute	On	Toggles all Mute Group Control on/off.	

Other Operations > The Functions that can be Assigned to User Defined Keys

Function	Parameter1	Parameter2	Parameter3	Description	
Oscillator	ON			Switches the oscillator on/off.	
	Sel Ch Assign			<p>Pressing the [SEL] key while this key is being pressed switches Assign on/off.</p> <p>The [SEL] LED is lit up when Assign is ON and dark when it is OFF. The Assign setting is also saved when this key is being pressed. The setting is recalled when the key is pressed again. Switches the Assign when settings are saved to multiple keys.</p>	
	Direct Assign	CH 1-120			Assigns the oscillator to the selected channel.
		MX 1-48			
		MATRIX 1-12			
		STEREO AL			
		STEREO AR			
		STEREO BL			
		STEREO BR			
		Monitor AL			
		Monitor AR			
		Monitor AC			
		Monitor BL			
Monitor BR					
Monitor BC					

Other Operations > The Functions that can be Assigned to User Defined Keys

Function	Parameter1	Parameter2	Parameter3	Description
Page Change	Bookmark	This Bay, Bay L, Bay C		Stores the currently displayed screen for each bay (when the key is pressed for 2 seconds or longer). Or, displays the last stored screen (when the key is pressed for under 2 seconds).
	Bookmark with SEL	This Bay, Bay L, Bay C		Stores the currently displayed screen and SEL status for each bay (when the key is pressed for 2 seconds or longer). Or, displays the last stored screen and restores the SEL status (when the key is pressed for under 2 seconds).
Recorder	Transport	Play		The transport functions of the RECORDER.
		Pause		
		Stop		
		FF		
		Next		
		Rew		
		Previous		
		Rec		
	Auto Rec		STOP → REC → PLAY shortcut function. Recording starts with one action. If executed during recording, the file being recorded in closes and recording continues in a new file.	
Rec & Start		A function to start recording right away without standby.		

Other Operations > The Functions that can be Assigned to User Defined Keys

Function	Parameter1	Parameter2	Parameter3	Description
Recorder	Direct Play	NO Assign		Plays the specified audio file(s) from the beginning. The audio file(s) to be played are those saved in the SONGS folder inside the YPE folder.
		(Title)		
Save File	USB1			Save the DM7 series settings.
	USB2			
	Internal			
Scene	Inc Recall			Recalls the scene with the next scene number.
	Dec Recall			Recalls the scene with the previous scene number.
	Direct Recall	(Scene)		Directly recalls a desired scene.
	Recall Undo			Cancels the recall operation.
	Update Undo			Cancels the store operation.
	Inc			Selects the scene number to be stored/recalled.
	Dec			
	Recall			Recalls a scene.
	Store			Newly stores the current mix data in the scene memory.
	Update			Overwrites and updates the current scene (last recalled or stored scene) with the current mix data.

Other Operations > The Functions that can be Assigned to User Defined Keys

Function	Parameter1	Parameter2	Parameter3	Description
Sends On Fader	MX 1-48	Normal	This Bay, Bay L, Bay C	Normal function on/off switching (NORMAL) and function on/off switching with CUE. With CUE enables the cue when Sends On Fader mode is entered or a switch occurs during Sends On Fader mode. When Sends On Fader mode is excited in With CUE, all output channel cues are cleared.
		With CUE	This Bay, Bay L, Bay C	
	MATRIX 1-12	Normal	This Bay, Bay L, Bay C	
		With CUE	This Bay, Bay L, Bay C	
	Sends On Fader	Normal	This Bay, Bay L, Bay C	
		With CUE	This Bay, Bay L, Bay C	
Set By SEL	Set [+48V]			Pressing the [SEL] key while this key is being pressed switches it on/off.
	Set [Phase]			
	Set [Insert On]			
	Set [Direct Out On]			The [SEL] LED is lit up when it is ON and dark when it is OFF.
	Set [Pre Send]			
	Set [To ST A]			
	Set [To ST B]			
	Set [To LCR]			
	Set [Gain Compensation On]			
Set Nominal Value				Pressing the [SEL] key while this key is being pressed sets the channel's FADER to nominal level. Pressing a parameter knob with a nominal setting also sets the parameter to nominal.
Solo	On			Switches the Solo function on/off.
Split	Side A	This Bay, Bay L, Bay C		Switches the unit mode side.
	Side B	This Bay, Bay L, Bay C		
	Toggle Side	This Bay, Bay L, Bay C		

Other Operations > The Functions that can be Assigned to User Defined Keys

Function	Parameter1	Parameter2	Parameter3	Description
Surround Pan	L On	Selected Ch	This Bay, Bay C, Bay L	Sets the surround pan.
		CH 1-120	-	
	R On	Selected Ch	This Bay, Bay C, Bay L	
		CH 1-120	-	
	C On	Selected Ch	This Bay, Bay C, Bay L	
		CH 1-120	-	
	LFE On	Selected Ch	This Bay, Bay C, Bay L	
		CH 1-120	-	
	Ls On	Selected Ch	This Bay, Bay C, Bay L	
		CH 1-120	-	
	Rs On	Selected Ch	This Bay, Bay C, Bay L	
		CH 1-120	-	
	Panning L	Selected Ch	This Bay, Bay C, Bay L	
		CH 1-120	-	
	Panning R	Selected Ch	This Bay, Bay C, Bay L	
		CH 1-120	-	
	Panning Front	Selected Ch	This Bay, Bay C, Bay L	
		CH 1-120	-	
	Panning Ls	Selected Ch	This Bay, Bay C, Bay L	
		CH 1-120	-	
Panning Rs	Selected Ch	This Bay, Bay C, Bay L		
	CH 1-120	-		
Panning Back	Selected Ch	This Bay, Bay C, Bay L		
	CH 1-120	-		
Panning Side L	Selected Ch	This Bay, Bay C, Bay L		
	CH 1-120	-		

Other Operations > The Functions that can be Assigned to User Defined Keys

Function	Parameter1	Parameter2	Parameter3	Description
Surround Pan	Panning Side R	Selected Ch	This Bay, Bay C, Bay L	Sets the surround pan.
		CH 1-120	-	
	Panning Center	Selected Ch	This Bay, Bay C, Bay L	
		CH 1-120	-	
	Panning Toggle	Selected Ch	This Bay, Bay C, Bay L	
		CH 1-120	-	
Talkback	On	Latch	Current Group, Group 1-8	Switches Talkback on/off.
		Unlatch	Current Group, Group 1-8	While pressed, Talkback is on.
	Talk Group	1-8	Pressing this key selects the specified Group. Pressing the [SEL] key for the output channel while this key is being pressed switches Assign on/off.	
TAP Tempo *1	Tempo 1-4			Sets the TAP Tempo.

*1. Tap Temp cannot be used on the Utility screen.

Setting a Custom Fader Bank

A set of channels assigned to the top-panel faders is called a "fader bank." There are input and output channel banks, as well as custom fader banks. Custom fader banks enable you to select various combinations of channels, regardless of channel types. You can also change the setting of the channels that will be controlled by the four main faders.

- 1 Press the Setup button on the menu bar.**
- 2 Press the User Setup button to access the USER SETUP screen.**
- 3 Press the Custom Fader button.**
The CUSTOM FADER screen appears.
- 4 Select the target BAY or main fader, and the target bank.**
- 5 Press the fader assign button you wish to set up.**
- 6 Select the channel you wish to assign to that fader on the CH SELECT screen that appears.**
The name of the selected channel will appear on the fader assign button.
- 7 To assign channels to other faders, repeat steps 4 and 5.**
- 8 When you finish selecting them, press the × symbol.**

Related links

"CUSTOM FADER screen" (p.113)

Using the Assist Function

This function supports the operator for setting up devices and rehearsals.

HA Assist

Suggests an appropriate gain value when an input channel is specified and the assist function is enabled. This is useful for making quick, fine adjustments to the HA of each channel during rehearsals. The targets are input channels with analog gain.

NOTE

If Gain Compensation is enabled, a gain value will not be correctly suggested.

Fader Assist

Suggests an appropriate fader level value when up to four groups of input channels are specified and the assist function is enabled. In Manual mode, the suggested value is manually applied. In Auto mode, the suggest value is automatically applied. The targets are input channels only.

NOTE

- Setting the appropriate icon (instrument type) to the target input channel improves the suggestion accuracy.
- Fader Assist channels are excluded if a Fader operation (touch sensitivity) is detected.
- Suggested Fader Assist values cannot be correctly set to input channels with channel pairs or channel link.

Naming Assist

Analyzes the audio input to a channel and suggests a recommended instrument as a candidate. Once the candidate is selected, the corresponding icon and instrument name are set. "NAME Screen" (p.272)

1 Press the Assist button on the Utility screen.



2 Select the function you want support for from Assist Type.

3 Press the channel selection button in either the CH 1-60 field of the CH 61-120 field to open the CH SELECT screen.

NOTE

Turn the Set by SEL button on to select the channel with the [SEL] button on the panel.

4 Select the channel being controlled on the CH SELECT screen.

NOTE

Channels can be registered in a group with Fader Assist.

- 5 Enable HA Assist or Enable Press Fader Assist to enable the function.**
- 6 HA Assist adjusts the gain on the 1ch GAIN screen or 12ch GAIN screen, and Fader Assist adjusts the balance on the Fader screen.**

Recommended values are shown in either HA Assist or Fader Assist.

HA Assist

1ch GAIN screen



12ch GAIN screen

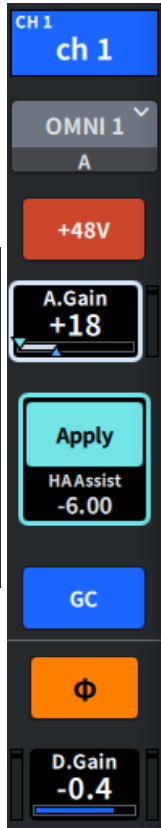

Fader Assist

Fader Screen

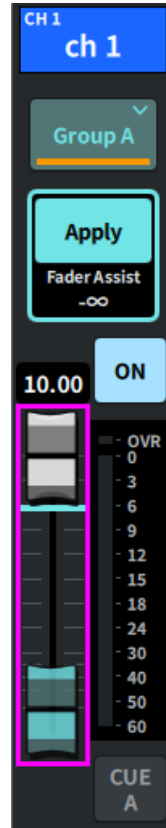

NOTE

Select Auto mode to make automatic settings with Fader Assist.

Related links

- “ASSIST Screen” (p.298)
- “NAME Screen” (p.272)

Using Split Mode

Using Split mode allows one console to take on two roles at the same time.

Examples of use

- Mixture of on-site and online
- Mixture of FOH and monitoring

NOTE

The data is initialized if the mode is switched, but the last data is stored in memory and restored when the mode is reverted to.

- 1 Press the System button on the Utility screen.**

2 Press the Unit Mode button on the SYSTEM screen.

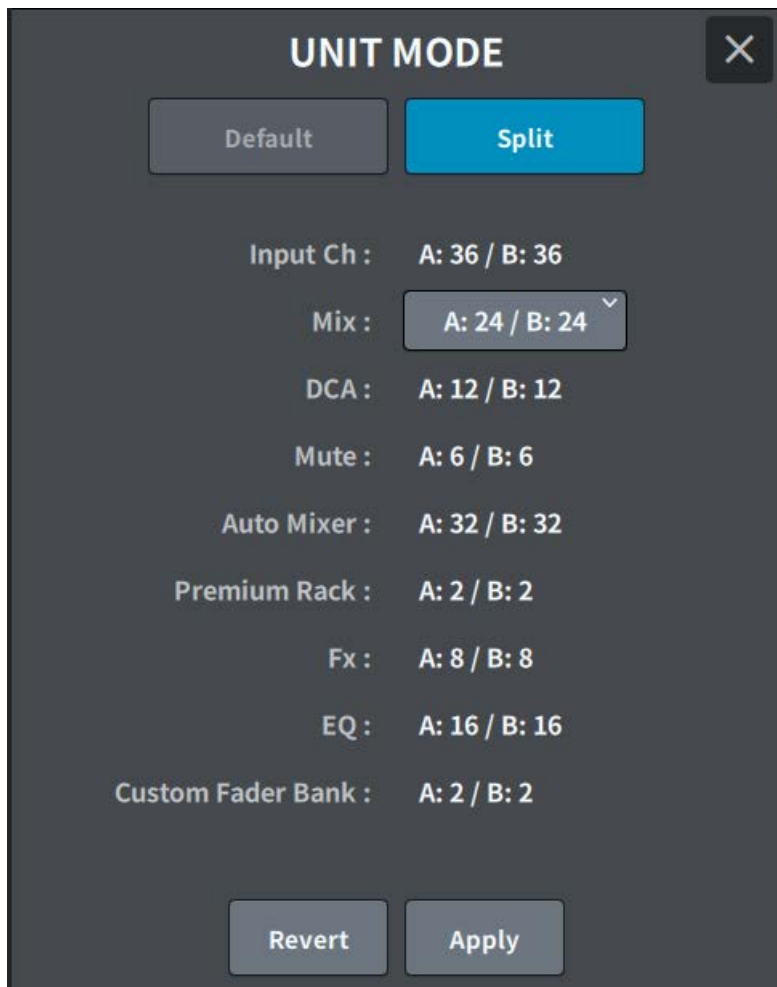

3 Press the Split button.

4 Select the Mix bus distribution.

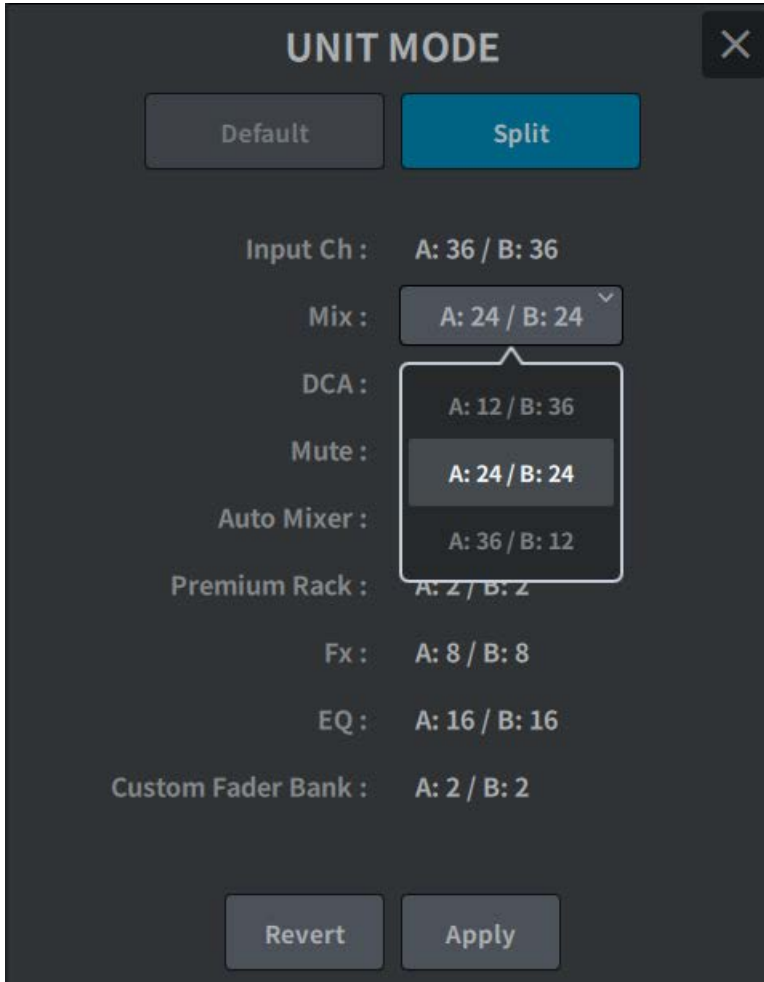

NOTE

The DM7 Series settings file cannot be loaded if the mode is different. This is also true if the Mix bus distribution is different.

5 Press the Apply button.

6 A popup window appears. Press the OK button to change the mode.

7 When the unit mode change is complete, a pop-up screen will appear to confirm reboot. Press the OK button to restart.

Other Operations > Using Split Mode

Related links

“UNIT MODE Screen” (p.308)

Actor Library Setting Procedure (Theater Package Compatible)

This section describes the steps to set up an actor library that is useful for managing substitute performers in theater applications. By storing each performer's EQ/DYN parameters in the actor library instead of the scene, and linking the actor library to the channel of the corresponding role, you can smoothly manage settings for substitute performers.

- 1 Press the Setup button on the menu bar.**
- 2 Press the General button to display the GENERAL screen.**
- 3 Press the Actor button.**
The ACTOR screen will be displayed.
- 4 Press the Actor button on the list to set the channel to Actor mode.**

NOTE

Channels set to Actor mode will have EQ/DYN increased to four banks, and EQ/DYN parameters other than bank selection will not be recalled by scenes.

- 5 Set and edit the actor library as needed.**

About Dante

The DM7 Series uses Dante as a protocol for transmitting audio signals. Dante is a network protocol developed by Audinate. It is designed to deliver multi-channel audio signals at various sampling and bit rates, as well as device control signals over a Giga-bit Ethernet (GbE) network. It also offers the following advantages.

- Theoretically, a total of 1,024 channels of audio can be transmitted in a Gigabit Ethernet environment: up to 512 in and 512 out.
- Devices in the network can be automatically detected and set, and device names can be set as desired.
- Using highly accurate network synchronization technology allows for low latency, low jitter, and high sample accuracy.
- The primary line and secondary line are redundantly connected in the unlikely event of a failure.
- Connecting to a computer via Ethernet allows audio to be directly input/output without an audio interface device.
- Audio can be transmitted between devices up to 100 m apart using a CAT5e network cable. However, the maximum practical distance may vary depending on the cable used.

Visit the Audinate website for more details on Dante:

<https://www.audinate.com/>

More information on Dante is also posted on the Yamaha Pro Audio website:

<https://www.yamahaproaudio.com/>

Please do not use the EEE function (*) of network switches in a Dante network.

Although power management should be negotiated automatically in switches that support EEE, some switches do not perform the negotiation properly. This may cause EEE to be enabled in Dante networks when it is not appropriate, resulting in poor synchronization performance and occasional dropouts. Therefore, we strongly recommend that:

- When using a managed switch, turn off the EEE function on all ports used for Dante. Do not use switches that cannot turn off the EEE function.
- When using unmanaged switches, do not use switches that support the EEE function. The EEE function cannot be turned off on these switches.

*EEE (Energy Efficient Ethernet) is a technology that reduces switch power consumption during periods of low network traffic. It is also known as Green Ethernet and IEEE802.3az.

Configuring Dante Controller

Connect the network port of the computer to a GbE-compatible network switch. Configure the computer to obtain an IP address automatically (this is the default setting). You must make the following settings for Dante Controller.

- For multitrack recording: Patch audio signals from the I/O DEVICE to the DVS or Dante Accelerator card for multitrack recording
- For virtual sound check: Patch audio signals in such a way that they will be output from the computer to the Dante audio network, then routed to the channels on the DM7 Series

During multitrack playback, you can switch these settings easily using the VIRTUAL SOUND CHECK ON button on the RECORDING PATCH screen.

NOTE

Please refer to the Dante Controller manual for more information about operations and settings of the Dante Controller.

Mounting an I/O DEVICE

Here's how to select a device from the multiple I/O DEVICES on the Dante audio network, and mount that device.

- 1 Press the I/O Device button on the menu bar.**
- 2 Press the DANTE I/O Device button to access the DANTE I/O DEVICE screen.**
- 3 Press a vacant I/O DEVICE select button.**
- 4 Press the I/O DEVICE button to access the DEVICE SELECT screen.**
- 5 Select the mounting method, and mount the I/O DEVICE.**

Related links

- “DANTE I/O DEVICE screen” (p.185)
- “DEVICE SELECT screen” (p.181)

Patching an I/O DEVICE

Here you can patch between an I/O DEVICE connected to a Dante connector and the Dante audio network.

- 1 Press the I/O Device button on the menu bar.**
- 2 Press the DANTE Patch button to access the DANTE PATCH screen.**
- 3 Press the Input button to access the Input tab of the DANTE PATCH screen.**
Set the patch being input to the Dante audio network from the I/O DEVICE. Use the Auto Setup button to set it in the Source list.
- 4 Press the Output tab to access the Output tab of the DANTE PATCH screen.**
Set the patch being output to the I/O DEVICE from the Dante audio network. Set it in the Source list.
- 5 When you finish making settings, press the × button to close the DANTE PATCH screen.**

NOTE

To input a signal from or output a signal to an I/O DEVICE, an input channel or output channel must be patched.

Related links

“DANTE SETUP (Device Mount) screen” (p.180)

Using the manual and shortcuts

Refer to the reference manual to find out about the console's functions, or use convenient shortcuts.

1 Press the Manual button on the Utility screen.

Press the Reference Manual button on the Manual screen to display a 2D code that references the URL to the reference manual.

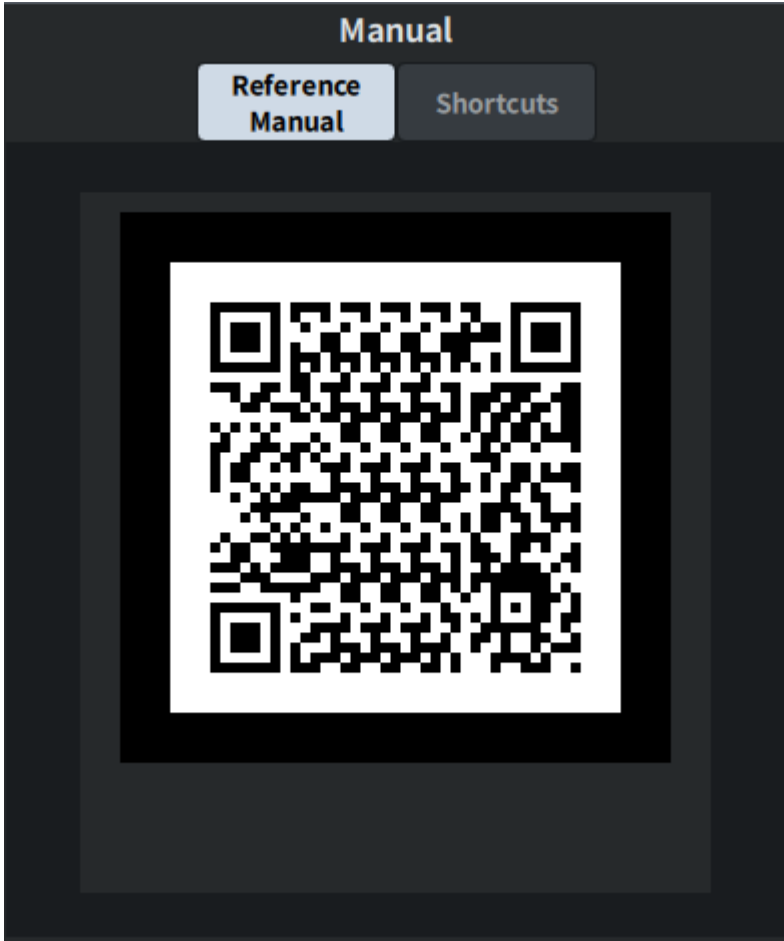

Press the Shortcuts button on the Manual screen to display convenient shortcuts.

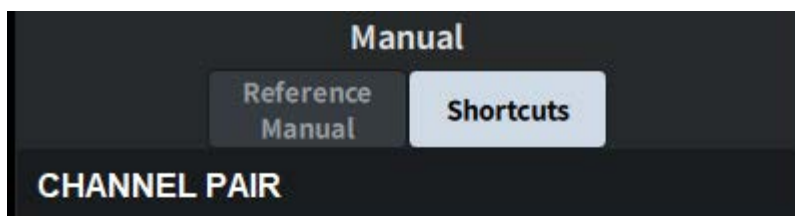

Create/Destroy Stereo paired channels

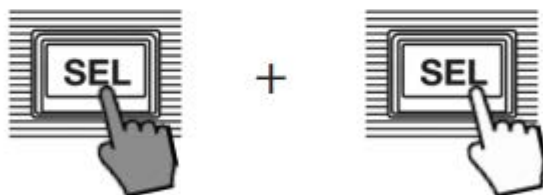

Neighbor channels

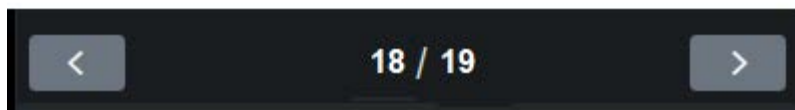

Use the arrow buttons at the bottom to move between pages.

DM7 Editor

About DM7 Editor

DM7 Editor is software that allows you to use your computer to perform offline editing by preparing the settings for the DM7 Series unit in advance, and to connect to the unit to monitor and adjust its settings (online monitoring/operation).

DM7 Editor and the DM7 Series are connected over a network. The DM7 Series unit and a computer on which DM7 Editor is installed are connected on the same network. For more information on configuring the network, please refer to the DM7 Editor Installation Guide.

NOTE

- DM7 Editor and DM7 StageMix can be used on up to three terminals at the same time. However, DM7 Editor can only be used on one of them.
- Parts of this software are based on open-source software. For information regarding software licenses, please see the License screen.

NOTICE

- The copyrights for this software and the PDF owner's manual belong to Yamaha Corporation.
- Neither this software nor the PDF owner's manual may be reproduced or modified in whole or in part without consent.
- Commercial music data may not be reproduced or transferred without the consent of the rights holder, except in cases of reproduction for personal use, etc. that do not violate the Copyright Act. Please consider consulting with a copyright expert before use.
- Please be aware that we bear no responsibility for the results or impact of using this software or the PDF owner's manual.
- All of the illustrations and screens in this PDF owner's manual are to explain operations. Please note that they may differ from the final specifications.
- Please visit the Yamaha Pro Audio website for changes to system software and some functions and specifications associated with application version upgrades, etc.
- Windows is a registered trademark of the Microsoft Corporation in the United States of America and other countries.
- Mac and Macintosh are trademarks of Apple Inc. registered in the United States of America and other countries.
- Other company names and product names are the trademarks and registered trademarks of their respective companies.

File Menu

The File menu is a menu for file operations.

NOTE

You can save files created in DM7 Editor in a USB storage device connected to the computer, and then load the files directly to the DM7 Series unit via the USB port. Similarly, if you save files from the DM7 Series unit to a USB storage device, you can load them into DM7 Editor.

The functions are as follows.

- Load:
Loads a saved file.
- Save:
Overwrite saves a file.
- Save As:
Saves a file under a different name.
- Import Scene/Library... :
Loads library and scene data in a file.
- Initialize Memory:
 - Current Memory:
Initializes the current DM7 Editor memory.
The data to be initialized are the mixing data and setup data.
 - All Memory:
Initializes all DM7 Editor memory.
The data to be initialized are all scenes, all presets, mixing data, and setup data.
- Load User Key:
Loads a user authentication key.
- Channel List:
Displays a screen where you can edit the channel icon, channel name, and channel color all at once.
- Exit:
Closes DM7 Editor.

Setup Menu

The Setup menu configures the environment for using DM7 Editor.

A checkmark appears when an item is selected, enabling the function. It is unchecked when selected again, disabling the function.

- Unicast Level Meter:
Displays level meter information even if the DM7 Series is on a different subnet.
- Ch Select Link:
Sets whether or not channel selection is synchronized with the unit during synchronization with the DM7 Series unit.
- Network Interface:
Selects the network port through which the DM7 Series unit and computer communicate.
The displayed contents differ depending on the usage environment.

Window Menu

The Window menu configures the screen display.

- Zoom:
Sets the application display size to either 50%, 75%, 100%, 125% or 150%.
- User Defined Control:
Displays the User Defined key screen.

Help Menu

The Help menu displays the DM7 Editor manual, version, and license information.

- Help:
Opens a Web browser to display the manual library.
- About:
Displays the About screen, which shows the version of DM7 Editor.

NOTE

You must connect to the Internet to view the manual library.

Editor Operation Overview

This section explains how to operate DM7 Editor using a mouse or keyboard.

Using the mouse wheel

You can use the mouse wheel as if you were operating the [TOUCH AND TURN] knob on the unit.

Using the PC keyboard

You can use the PC keyboard to enter text as if you were operating the KEYBOARD screen on the unit.

Using the touch screen

DM7 Editor can be operated by touching the display on a touch screen computer, etc.

Operation during Editor Startup

When DM7 Editor is started up, the screen to select the DM7 Series model appears. Select the model and click the Start button to launch the Editor.

Editor and Unit Synchronization

When DM7 Editor is started up, the parameter settings in the DM7 Series unit and DM7 Editor are different. Therefore, the DM7 Series unit and DM7 Editor settings must first be synchronized.

Before synchronization, configure the network interface.

- 1 Click the ONLINE button on the Utility screen.**
- 2 Select the network interface being used from the Network Interface list.**
- 3 Select the DM7 Series unit being synchronized and the direction of synchronization.**

The synchronized DM7 Series can select the configured model when the DM7 Editor is launched.

Use the Direct IP button to directly specify the IP address without running an automated search. Turn UniCast Level Meter on the Setup menu on to display level meter information, even if the DM7 Series is on a different subnet.

If the maximum number (up to 3) has already been reached for the DM7 Editor and DM7 StageMix connected to the DM7 Series unit, a prohibited symbol is displayed to the left of the IP Address. Even if the prohibited symbol is not displayed, when the DM7 Series unit is selected and the Connect button is pressed, a message may appear indicating that connection was not possible depending on the connection conditions of other DM7 Editor and DM7 StageMix applications.

The synchronization directions are as follows.

DM7→PC

Parameter settings on the DM7 Series unit will be copied to DM7 Editor.

DM7←PC

Parameter settings on DM7 Editor unit will be copied to the DM7 Series unit.

- 4 If an Administrator password is set up on the DM7 Series unit, enter the password.**
- 5 Click the Connect button.**

Do not operate the DM7 Series unit during synchronization.

Editor's Offline Edit Function

If the DM7 Series unit and DM7 Editor are not linked, click the ONLINE button on the Utility screen to switch to offline. To reflect the contents edited offline in the DM7 Series unit, click the ONLINE button again to synchronize in the order of DM7<-DM7 Editor.

Appendix

FX Parameters

Reverb HD Hall, Reverb HD Room, Reverb HD Plate

These are highly dense reverb simulations directly from Yamaha.

- HD Hall is reverb that simulates a concert hall
- HD Room is reverb that simulates room acoustics
- HD Plate is reverb that simulates plate echo

Parameter	Range	Description
Reverb Time	0.3s - 30.0s	The length of the reverb
Room Size	0 - 4	(HALL and ROOM only) The size of the space where the sound is playing
Plate Type	0 - 2	(PLATE only) The reverb quality
Initial Delay	0.1ms - 200.0ms	The delay until the early reflected sound of the reverb is produced
High Damp Freq	1.0kHz - 20.0kHz	Adjusts high-frequency attenuation
High Ratio	0.1 - 1.0	The ratio of the high-frequency reverb time with respect to the Reverb Time
HPF	Thru, 21.2Hz - 8.00kHz	The cutoff frequency of the high pass filter
LPF	50.0Hz - 16.0kHz, Thru	The cutoff frequency of the low pass filter

Space Simulator

Reverb that can configure the space using width, height, and depth.

Parameter	Range	Description
Reverb Time	0.3s - 30.0s	The length of the reverb
Width	0.5m - 30.2m	Width of space
Height	0.5m - 30.2m	Height of space
Depth	0.5m - 30.2m	Depth of space
Wall Vary	0 - 30	The conditions of the walls in the space. A larger value means stronger diffusion, and a smaller value means weaker diffusion
Space Type	0 - 1	The type of space simulation
Initial Delay	0.1ms - 200ms	The delay until the early reflected sound of the reverb is produced
High Ratio	0.1 - 1.0	The ratio of the high-frequency reverb time with respect to the REV TIME
Diffusion	0 - 10	The horizontal spread of the reverb
Density	0 - 4	The density of the reverb
HPF	Thru, 21.2Hz - 8.00kHz	The cutoff frequency of the high pass filter
LPF	50.0Hz - 16.0kHz, Thru	The cutoff frequency of the low pass filter
E/R Delay	0.1ms - 200.0ms	The delay from the early reflected sound until the reverb
ER/Rev Balance	E63>R - E<R63	The level balance between the early reflected sound and the reverb
Feedback Gain	-99% - +99%	The feedback amount from the initial delay

Gate Reverb

The early reflected sound of the gate reverb.

Parameter	Range	Description
Type	Type-A, Type-B	The pattern type of the early reflected sound
Room Size	0.1 - 20.0	The size of the room (the reflected sound interval)
Liveness	0 - 10	How the reflected sound is attenuated (0: dead, 10: Live)
Initial Delay	0.1ms - 200.0ms	The delay until the early reflected sound is produced
Diffusion	0 - 10	The horizontal spread of the reflected sound
Density	0 - 3	The density of the reflected sound
Feedback Gain	-99% - +99%	The feedback amount
High Ratio	0.1 - 1.0	The high-frequency feedback
HPF	Thru, 21.2Hz - 8.00kHz	The cutoff frequency of the high pass filter
LPF	50.0Hz - 16.0kHz, Thru	The cutoff frequency of the low pass filter

Reverb R3 Hall, Reverb R3 Room, Reverb R3 Plate

This is reverb that uses algorithms directly from the ProR3, professional reverb equipment.

- R3 Hall is reverb that simulates a concert hall
- R3 Room is reverb that simulates room acoustics
- R3 Plate is reverb that simulates plate echo

Parameter	Range	Description
Reverb Time	0.3s - 30.0s	The length of the reverb
Initial Delay	0.1ms - 200ms	The delay until the early reflected sound of the reverb is produced
High Ratio	0.1 - 1.0	The ratio of the high-frequency reverb time with respect to the REV TIME
Diffusion	0 - 10	The horizontal spread of the reverb
Density	0 - 4	The density of the reverb
HPF	Thru, 21.2Hz - 8.00kHz	The cutoff frequency of the high pass filter
LPF	50.0Hz - 16.0kHz, Thru	The cutoff frequency of the low pass filter
Reverb Delay	0.1ms - 200.0ms	The delay from the early reflected sound until the reverb
ER/Rev Balance	E63>R - E<R63	The level balance between the early reflected sound and the reverb
Feedback Gain	-99% - +99%	The feedback amount from the initial delay

Early Reflection

2IN/2 OUT early reflections. An effect in which only the early reflected sound of the reverb is extracted.

Parameter	Range	Description
Type	S-Hall, L-Hall, Random, Reverse, Plate, Spring	The pattern type of the early reflected sound
Room Size	0.1 - 20.0	The size of the room (the reflected sound interval)
Liveness	0 - 10	How the reflected sound is attenuated (0: dead, 10: Live)
Initial Delay	0.1ms - 200.0ms	The delay until the early reflected sound is produced
Diffusion	0 - 10	The horizontal spread of the reflected sound
Density	0 - 3	The density of the reflected sound
Feedback Gain	-99% - +99%	The feedback amount
High Ratio	0.1 - 1.0	The high-frequency feedback
HPF	Thru, 21.2Hz - 8.00kHz	The cutoff frequency of the high pass filter
LPF	50.0Hz - 16.0kHz, Thru	The cutoff frequency of the low pass filter

Reverb Gate

2 IN/2 OUT gate reverb.

Parameter	Range	Description
Type	Type-A, Type-B	The pattern type of the early reflected sound
Room Size	0.1 - 20.0	The size of the room (the reflected sound interval)
Liveness	0 - 10	How the reflected sound is attenuated (0: dead, 10: Live)
Initial Delay	0.1ms - 200.0ms	The delay until the early reflected sound is produced
Diffusion	0 - 10	The horizontal spread of the reflected sound
Density	0 - 3	The density of the reflected sound
Feedback Gain	-99% - +99%	The feedback amount
High Ratio	0.1 - 1.0	The high-frequency feedback
HPF	Thru, 21.2Hz - 8.00kHz	The cutoff frequency of the high pass filter
LPF	50.0Hz - 16.0kHz, Thru	The cutoff frequency of the low pass filter

Reverb Hall, Reverb Room, Reverb Stage

This is hall, room, and stage reverb directly from the SPX1000.

Parameter	Range	Description
Reverb Time	0.3s - 30.0s	The length of the reverb
Initial Delay	0.1ms - 200ms	The delay until the early reflected sound of the reverb is produced
High Ratio	0.1 - 1.0	The ratio of the high-frequency reverb time with respect to the REV TIME
Diffusion	0 - 10	The horizontal spread of the reverb
Density	0 - 4	The density of the reverb
HPF	Thru, 21.2Hz - 8.00kHz	The cutoff frequency of the high pass filter
LPF	50.0Hz - 16.0kHz, Thru	The cutoff frequency of the low pass filter
Reverb Delay	0.1ms - 200.0ms	The delay from the early reflected sound until the reverb
ER/Rev Balance	E63>R - E<R63	The level balance between the early reflected sound and the reverb
Feedback Gain	-99% - +99%	The feedback amount from the initial delay

Mono Delay

Basic 2IN/2 OUT repeat delay.

Parameter	Range	Description
Delay	1.0 - 2700.0ms	Delay time
Feedback Gain	-99 - +99	The feedback amount
High Ratio	0.1 - 1.0	The amount of high-frequency feedback
HPF	Thru, 21.2Hz - 8.00kHz	The cutoff frequency of the high pass filter
LPF	50.0Hz - 16.0kHz, Thru	The cutoff frequency of the low pass filter
Sync	OFF, ON	Tempo parameter synchronization on/off
Note	----, *1 - *14	The value for converting the DELAY from the tempo

Stereo Delay

Basic 2 IN/2 OUT stereo delay.

Parameter	Range	Description
Delay L	1.0 - 1350.0ms	The delay time of the L-channel
Delay R	1.0 - 1350.0ms	The delay time of the R-channel
Feedback Gain L	-99 - +99	The feedback amount of the L-channel
Feedback Gain R	-99 - +99	The feedback amount of the R-channel
High Ratio	0.1 - 1.0	The amount of high-frequency feedback
HPF	Thru, 21.2Hz - 8.00kHz	The cutoff frequency of the high pass filter
LPF	50.0Hz - 16.0kHz, Thru	The cutoff frequency of the low pass filter
Sync	OFF, ON	Tempo parameter synchronization on/off
Note L	----, *1 - *14	The value for converting the DELAY L from the tempo
Note R	----, *1 - *14	The value for converting the DELAY R from the tempo

Delay LCR

2 IN/2 OUT 3-tap delay.

Parameter	Range	Description
Delay L	1.0 - 2700.0ms	The delay time of the L-channel
Delay C	1.0 - 2700.0ms	The delay time of the center channel
Delay R	1.0 - 2700.0ms	The delay time of the L-channel
Delay FB	1.0 - 2700.0ms	The delay time of the feedback
Feedback Gain	-99 - +99	The feedback amount
High Ratio	0.1 - 1.0	The amount of high-frequency feedback
HPF	Thru, 21.2Hz - 8.00kHz	The cutoff frequency of the high pass filter
LPF	50.0Hz - 16.0kHz, Thru	The cutoff frequency of the low pass filter
Level L	-100 - +100	The level of the L-channel
Level C	-100 - +100	The level of the center channel
Level R	-100 - +100	The level of the R-channel
Sync	OFF, ON	Tempo parameter synchronization on/off
Note L	----, *1 - *14	The value for converting the DELAY L from the tempo
Note C	----, *1 - *14	The value for converting the DELAY C from the tempo
Note R	----, *1 - *14	The value for converting the DELAY R from the tempo
Note FB	----, *1 - *14	The value for converting the DELAY FB from the tempo

Cross Delay

This is a type of delay in which the delay sound jumps left and right.

Parameter	Range	Description
Delay L>R	1.0 - 1638.3ms	The delay time from left to right
Delay R>L	1.0 - 1638.3 ms	The delay time from right to left
Feedback Gain	-99 - +99	The feedback amount
In Select	L - R Mode2	The input channel selection
High Ratio	0.1 - 1.0	The amount of high-frequency feedback
HPF	Thru, 21.2Hz - 8.00kHz	The cutoff frequency of the high pass filter
LPF	50.0Hz - 16.0kHz, Thru	The cutoff frequency of the low pass filter

Tempo Cross Delay

A type of cross delay that synchronizes the delay time with the tempo.

Parameter	Range	Description
Delay L>R	1.0 - 1638.3ms	The delay time from left to right
Delay R>L	1.0 - 1638.3 ms	The delay time from right to left
Feedback Gain	-99 - +99	The feedback amount
In Select	L - R Mode2	The input channel selection
High Ratio	0.1 - 1.0	The amount of high-frequency feedback
Lag	-63ms - +63ms	Applies a lag to the delay specified by a note
HPF	Thru, 21.2Hz - 8.00kHz	The cutoff frequency of the high pass filter
LPF	50.0Hz - 16.0kHz, Thru	The cutoff frequency of the low pass filter

Echo

2 IN/2 OUT stereo delay with cross-feedback loop.

Parameter	Range	Description
Delay L	1.0 - 1350.0ms	The delay time of the L-channel
Delay R	1.0 - 1350.0ms	The delay time of the R-channel
Delay FB L	1.0 - 1350.0ms	The feedback delay time of the L-channel
Delay FB R	1.0 - 1350.0ms	The feedback delay time of the R-channel
Feedback Gain L	-99 - +99	The feedback amount of the L-channel
Feedback Gain R	-99 - +99	The feedback amount of the R-channel
XFeedback Gain	-99 - +99	The L->R, R->L feedback amount
High Ratio	0.1 - 1.0	The amount of high-frequency feedback
HPF	Thru, 21.2Hz - 8.00kHz	The cutoff frequency of the high pass filter
LPF	50.0Hz - 16.0kHz, Thru	The cutoff frequency of the low pass filter
Sync	OFF, ON	Tempo parameter synchronization on/off
Note L	----, *1 - *14	The value for converting the DELAY L from the tempo
Note R	----, *1 - *14	The value for converting the DELAY R from the tempo
Note FBL	----, *1 - *14	The value for converting the DELAY FB L from the tempo
Note FBR	----, *1 - *14	The value for converting the DELAY FB R from the tempo

Ping Pong Delay

2 IN/2 OUT ping pong delay. A delay effect in which the delay sound is repeated at equal intervals alternately on the left and right.

Parameter	Range	Description
Delay	1.0ms - 1350.0ms	Delay time
Feedback Gain	-99% - +99%	The feedback amount
High Ratio	0.1 - 1.0	The amount of high-frequency feedback
HPF	Thru, 21.2Hz - 8.00kHz	The cutoff frequency of the high pass filter
LPF	50.0Hz - 16.0kHz, Thru	The cutoff frequency of the low pass filter
Sync	Off, On	Tempo parameter synchronization on/off
Note	----, *1 - *14	The value for converting the DELAY from the tempo

Analog Delay Modern

A simulation effect of analog delay using a BBD element. The BBD element's configuration is the long delay configuration.

Parameter	Range	Description
Delay	50 - 1000.0 ms	Delay time
Feedback Gain	-99 - +99	The feedback amount
Delay In Level	0 - 100	The delay input level
Type	Urban / Dark	The delay character

Analog Delay Retro

A simulation effect of analog delay using a BBD element. The BBD element's configuration is the short delay configuration.

Parameter	Range	Description
Delay	25 - 800 ms	Delay time
Feedback Gain	-99 - +99	The feedback amount
Input Level	0 - 100	The delay input level
Type	Mellow / Dark	The delay character

Chorus

2 IN/2 OUT chorus effect.

Parameter	Range	Description
Frequency	0.05Hz - 10.00Hz	The speed of modulation
AM Depth	0% - 100%	The depth of amplitude modulation
PM Depth	0% - 100%	The depth of pitch modulation
MOD. Delay	1.0ms - 500.0ms	The modulation delay time
Sync	Off, On	Tempo parameter synchronization on/off
Note	*1 - *14	The value for converting the Frequency from the tempo

Symphonic

2 IN/2 OUT symphonic effect.

Parameter	Range	Description
Frequency	0.05Hz - 10.00Hz	The speed of modulation
Depth	0% - 100%	The depth of modulation
MOD. Delay	1.0ms - 500.0ms	The modulation delay time
Sync	Off, On	Tempo parameter synchronization on/off
Note	*1 - *14	The value for converting the Frequency from the tempo

Flanger

2 IN/2 OUT flange effect.

Parameter	Range	Description
Frequency	0.05Hz - 10.00Hz	The speed of modulation
Depth	0% - 100%	The depth of modulation
MOD. Delay	1.0ms - 500.0ms	The modulation delay time
Feedback Gain	-99% - +99%	The feedback amount
Sync	Off, On	Tempo parameter synchronization on/off
Note	*1 - *14	The value for converting the Frequency from the tempo

Phaser

2 IN/2 OUT 16-stage effect.

Parameter	Range	Description
Frequency	0.05Hz - 10.00Hz	The speed of modulation
Depth	0% - 100%	The depth of modulation
Feedback Gain	-99% - +99%	The feedback amount
Stage	2 - 16	The number of phase shift stages
HPF	Thru, 21.2Hz - 8.00kHz	The cutoff frequency of the high pass filter
LPF	50.0Hz - 16.0kHz, Thru	The cutoff frequency of the low pass filter
Sync	Off, On	Tempo parameter synchronization on/off
Note	*1 - *14	The value for converting the FREQ. from the tempo

Auto Pan

An effect that periodically moves the sound image (pan) left and right.

Parameter	Range	Description
Frequency	0.0Hz - 39.70Hz	The auto pan frequency
L/R Depth	0% - 100%	The left-right pan depth
F/R Depth	0% - 100%	The forward-rear pan depth
Pan Direction	L<>R, L>>R, L<<R, LTurn, RTurn, L/R	The type of auto pan
Wave	0 - 28	Changes the panning curve
LSF Freq	21.2Hz - 8.0kHz	The Low EQ Freq
LSF Gain	-12dB - +12dB	The Low EQ Gain
EQ Freq	100Hz - 8.0kHz	The Mid EQ Freq
EQ Gain	-12dB - +12dB	The Mid EQ Gain
EQ Q	0.1 - 12.0	The Mid EQ Q
HSF Freq	50.0Hz - 16.0kHz	The High EQ Freq
HSF Gain	-12dB - +12dB	The High EQ Gain
Input Mode	Mono / Stereo	Input mono/stereo

Tremolo

An effect that periodically changes the volume.

Parameter	Range	Description
Frequency	0.0Hz - 39.70Hz	The modulation frequency
AM Depth	0% - 100%	The depth of amplitude modulation
PM Depth	0% - 100%	The depth of pitch modulation
LFO Phase Diff.	-180deg - +180deg	The L/R phase difference of the modulated wave system
LSF Freq	21.2Hz - 8.0kHz	The Low EQ Freq
LSF Gain	-12dB - +12dB	The Low EQ Gain
EQ Freq	100Hz - 8.0kHz	The Mid EQ Freq
EQ Gain	-12dB - +12dB	The Mid EQ Gain
EQ Q	0.1 - 12.0	The Mid EQ Q
HSF Freq	50.0Hz - 16.0kHz	The High EQ Freq
HSF Gain	-12dB - +12dB	The High EQ Gain
Input Mode	Mono / Stereo	Input mono/stereo

Rotary Speaker

An effect that simulates a rotary speaker.

Parameter	Range	Description
Rotor Speed Slow	0.0Hz - 2.65Hz	The rotor's rotation speed during slow rotation
Horn Speed Slow	0.0Hz - 2.65Hz	The horn's rotation speed during slow rotation
Rotor Speed Fast	2.69Hz - 39.70Hz	The rotor's rotation speed during fast rotation
Horn Speed Fast	2.69Hz - 39.70Hz	The horn's rotation speed during fast rotation
Slow-Fast time of Rotor	0 - 100	The transition time when switching rotational speeds of the rotor
Slow-Fast time of Horn	0 - 100	The transition time when switching rotational speeds of the horn
Drive Rotor	0 - 100	The depth of modulation from rotor rotation
Drive Horn	0 - 100	The depth of modulation from horn rotation
Rotor/Horn Balance	0 - 100	The horn and rotor volume balance
LSF Freq	21.2Hz - 8.0kHz	The Low EQ Freq
LSF Gain	-12dB - +12dB	The Low EQ Gain
HSF Freq	50.0Hz - 16.0kHz	The High EQ Freq
HSF Gain	-12dB - +12dB	The High EQ Gain
Mic L-R Angle	0deg - 180deg	The L/R angle of the mic from which output is taken
Speed Control	Slow / Fast	Rotation speed switch

Amp Simulator

An effect that simulates a guitar amp.

Parameter	Range	Description
Drive	0 - 100	The degree of distortion
Type	0 - 4	A device that changes the way sound is distorted
Speaker Type	0 - 5	The speaker type
Presence	-10 - 10	Controls a wide area
Output Level	0 - 100	The output level

Comp Distortion

A compressor + distortion effect.

Parameter	Range	Description
Drive	0 - 100	The degree of distortion
LSF Freq	21.2Hz - 8.0kHz	The Low EQ Freq
LSF Gain	-12dB - +12dB	The Low EQ Gain
LPF	50.0Hz - Thru	The Low EQ Gain
Output Level	0 - 100	The output level
EQ Freq	100Hz - 8.0kHz	The Mid EQ Freq
EQ Gain	-12dB - +12dB	The Mid EQ Gain
EQ Q	0.1 - 12.0	The Mid EQ Q
Edge (Clip Curve)	0 - 100	
Attack	1ms - 40ms	
Release	10ms - 680ms	
Threshold	-48dB - -6dB	
Ratio	1.0 - 20.0	

M. Band Comp

An effect that divides the bandwidth into three bands and applies a compressor to each band separately.

Parameter	Range	Description
Low Attack	1ms - 200ms	The time until the compressor begins to work in the low frequency range
Low Threshold	-54dB - -6dB	The input level at which the effect begins to take effect in the low frequency range
Low Ratio	1.0 - 20.0	The compression ratio of the compressor in the low frequency range
Low Gain	-∞ - 18dB	The output level in the low frequency range
Mid Attack	1ms - 200ms	The time until the compressor begins to work in the mid frequency range
Mid Threshold	-54dB - -6dB	The input level at which the effect begins to take effect in the mid frequency range
Mid Ratio	1.0 - 20.0	The compression ratio of the compressor in the mid frequency range
Mid Gain	-∞ - 18dB	The output level in the mid frequency range
High Attack	1ms - 200ms	The time until the compressor begins to work in the high frequency range
High Threshold	-54dB - -6dB	The input level at which the effect begins to take effect in the high frequency range
High Ratio	1.0 - 20.0	The compression ratio of the compressor in the high frequency range
High Gain	-∞ - 18dB	The output level in the high frequency range
Divide Freq Low	16Hz - 20Hz	The Low/Mid frequency for dividing the bandwidth into three bands
Divide Freq High	16Hz - 20Hz	The Mid/High frequency for dividing the bandwidth into three bands
Common Release	10ms - 3000ms	The common release time set for all three bands

VCM Auto Wah

Auto-wah that uses VCM technology. Periodically changes the center frequency of the filter.

Parameter	Range	Description
Frequency	0.100Hz - 20.00Hz	The LFO speed
Bottom	0 - 100	The lowest value of the wah filter's variable range
Top	0 - 100	The highest value of the wah filter's variable range
Reso. Offset	-12.0 - 12.0	The offset of the resonance
Wave	Sin / Trp	Selects the waveform (either sine wave or square wave)
Type	High, Mid, Low, Bass	Selects the wah type
Drive	0.0dB - 40.0dB	The degree of distortion
Output	-20.0dB - 10.0dB	The output level

Ring Mod.

An effect that changes the input sound to a metallic sound.

Parameter	Range	Description
OSC Freq Coarse	0.5Hz - 5.0kHz	The frequency for modulating the input waveform
OSC Freq Fine	0 -100	A more fine-tuned setting of the frequency for modulating the input waveform
LFO Wave	Tri / Sine	Selects the modulation waveform
LFO Depth	0% - 100%	Sets the depth of modulation
LFO Freq	0.0Hz - 39.70Hz	The modulation frequency
HPF	Thru - 8.0kHz	The cutoff frequency of the high pass filter
LPF	50kHz - Thru	The cutoff frequency of the low pass filter
Mod. Input Level		
LSF Freq	21.2Hz - 8.0kHz	The Low EQ Freq
LSF Gain	-12dB - +12dB	The Low EQ Gain
HSF Freq	50.0Hz - 16.0kHz	The High EQ Freq
HSF Gain	-12dB - +12dB	The High EQ Gain

Dynamic Ring Mod.

An effect that controls the Ring Modulator parameter "OSC Freq" in real time with the input audio level.

Parameter	Range	Description
Sensitivity	0 - 100	The modulation sensitivity towards input changes
HPF	Thru - 8.0kHz	The cutoff frequency of the high pass filter
LPF	50kHz - Thru	The cutoff frequency of the low pass filter
Attack Time	0.3ms - 227ms	The attack time of the envelope follower
Release Time	2.6ms - 2171ms	The release time of the envelope follower
Release Curve	0 - 127	The release curve of the envelope follower
Direction	up / down	The direction of approach of the envelope follower
Lvl Offset	0 - 100	The offset added to envelope follower output
LSF Freq	21.2Hz - 8.0kHz	The Low EQ Freq
LSF Gain	-12dB - +12dB	The Low EQ Gain
HSF Freq	50.0Hz - 16.0kHz	The High EQ Freq
HSF Gain	-12dB - +12dB	The High EQ Gain

Auto Synth

An effect that resynthesizes the input signal by combining the delay and modulation.

Parameter	Range	Description
Mod Speed	0 - 100	The speed of modulation
Mod Wave Type	TypeA, TypeB, TypeC, TypeD	The modulation waveform
Mod Depth	0 - 100	The depth of modulation
Mod Depth Ofst R	-63 - +63	The offset of the depth of modulation in the R-channel
HPF	Thru - 8.0kHz	The cutoff frequency of the high pass filter
LPF	50kHz - Thru	The cutoff frequency of the low pass filter
Delay Time	0.1ms - 170.0ms	The delay length
Delay Time Ofst R	0 - 884	The offset of the delay length in the R-channel
Delay Mix	0 - 100	The delay sound level
FB Gain	-99% - +99%	The feedback amount
FB Level Ofst R	-99% - +99%	The offset of the feedback amount in the R-channel
AM Speed	0.00Hz - 39.70Hz	The speed of volume modulation
AM Wave	Tri, Sine, Saw, Up, Saw Down	The volume modulation waveform
AM Depth	0% - 100%	The depth of volume modulation
AM Inverse R	Normal / Inverse	The phase of volume modulation in the R-channel

Dual Pitch

2 IN/2 OUT pitch shift effect.

Parameter	Range	Description
Pitch 1	-24 - +24	Ch1 pitch (in semitones)
Fine 1	-50 - +50	Ch1 pitch (in cents)
Level 1	-100 - +100	Ch1 volume
Pan 1	L63 - R63	Ch1 pan
Delay 1	1.0ms - 1000.0ms	Ch1 delay time
Feedback Gain 1	-99 - +99	Ch1 feedback level
Pitch 2	-24 - +24	Ch2 pitch (in semitones)
Fine 2	-50 - +50	Ch2 pitch (in cents)
Level 2	-100 - +100	Ch2 volume
Pan 2	L63 - R63	Ch2 pan
Delay 2	1.0ms - 1000.0ms	Ch2 delay time
Feedback Gain 2	-99 - +99	Ch2 feedback level
Sync	Off, On	Tempo parameter synchronization on/off
Note1	----, *1 - *14	The value for converting DELAY 1 from the tempo
Note2	----, *1 - *14	The value for converting DELAY 2 from the tempo

Dynamic Filter

A filter that controls the cutoff frequency in real time with the input audio level.

Parameter	Range	Description
Filter Type	LPF(12dB), LPF(18dB), LPF(24dB), HPF, BPF, BEF	The filter type
Sensitivity	0 - 100	The modulation sensitivity towards input changes
Lvl Offset	0 - 100	The offset added to envelope follower output
Resonance	-16 - 111	Applies resonance to the filter
Attack Time	0.3ms - 227ms	The attack time of the envelope follower
Release Time	2.6ms - 2171ms	The release time of the envelope follower
Release Curve	0 - 100	The release curve of the envelope follower
Direction	Up / Down	The direction of approach of the envelope follower
Threshold	0 - 100	The movement level of the envelope follower
LSF Freq	32Hz - 2.0kHz	The Low EQ Freq
LSF Gain	-12dB - +12dB	The Low EQ Gain
HSF Freq	500Hz - 16.0kHz	The High EQ Freq
HSF Gain	-12dB - +12dB	The High EQ Gain

Isolator

An effect that controls the volume per band using a powerful filter.

Parameter	Range	Description
On/Off Switch	On / Off	Isolator On/Off
Low Level	-64 - +63	Low frequency level
Mid Level	-64 - +63	Mid frequency level
High Level	-64 - +63	High frequency level
Low Mute	On / Off	Low frequency mute
Mid Mute	On / Off	Mid frequency mute
High Mute	On / Off	High frequency mute

Delay notes

- *1 :



- *2 :



- *3 :



Appendix > FX Parameters

• *4 :



• *5 :



• *6 :



• *7 :



• *8 :



• *9 :



• *10 :



• *11 :



• *12 :



• *13 :



• *14 :



Premium Parameters

REV-X

2 IN/2 OUT reverb algorithm. It provides a high-density, richly reverberant sound quality, with smooth attenuation, and spread and depth that work together to enhance the original sound. You can choose one of three programs to suit the acoustic sound field and your intentions: REV-X Hall, REV-X Room, and REV-X Plate.

Parameter	Range	Description
REV TYPE	HALL, ROOM, PLATE	The type of reverb.
REV TIME	0.28–27.94 s *1	The length of the reverb
INI. DLY	1.0–125.0 ms	The delay until the early reflected sound of the reverb is produced
HI. RATIO	0.1–1.0	Expresses the ratio of the high-frequency reverb time with respect to the REV TIME
LO. RATIO	0.1–1.4	Expresses the ratio of the low-frequency reverb time with respect to the REV TIME
LO.FREQ	22.0 Hz–18.0 kHz	LO. Frequency value that serves as the basis for the RATIO value
DIFF.	0–10	The horizontal spread of the reverb
ROOM SIZE	0–28	The size of the space
DECAY	0–53	The speed at which the gate closes
HPF	THRU, 22.0 Hz–8.00 kHz	The cutoff frequency of the high pass filter
LPF	1.00 kHz–18.0 kHz, THRU	The cutoff frequency of the low pass filter

*1. The value when the effect type is REV-X HALL and the ROOM SIZE is 28. The range will vary depending on the effect type and ROOM SIZE value.

Analog Delay

This delay effect is based on the Yamaha E1010 analog delay.

Parameter	Range	Description
BBD TYPE	A, B, C, D, E	Adjust the characteristics of the delay sound. The characteristics become stronger in the order of switch A to E.
TIME RANGE	1-200, 201-600, 601-1000	Specifies the delay time range controlled via the DELAY knob.
INPUT	0.00 to 10.00	Adjusts the input gain.
BASS	-15.00 to 15.00	Adjusts the low frequency range level at the input stage.
TREBLE	-15.00 to 15.00	Adjusts the high frequency range level at the input stage.
DELAY	1 to 200 ms, 201 to 600 ms, 601 to 1000 ms	Adjusts the delay time.
FEEDBACK	0.00 to 10.00	Adjusts the feedback amount of the delay time.
FREQUENCY	0.00 to 20.0 Hz	Adjusts the frequency of modulation.
DEPTH	0.00 to 10.00	Adjusts the depth of modulation.
MIX	0.00 to 10.00	Adjusts the mix balance between dry and delay sounds.
SYNC	OFF, ON	Switches the tempo parameter sync on/off

Max100

Complete reproduction of a vintage effect that was manufactured only during the late 1970s.

Parameter	Range	Description
MODE	1 to 4	The timbre switch
SPEED	SYNC ON, 0.100 to 10.00 Hz	The modulation speed
FOOT	OFF, ON	Switches the effect on/off

Dyna.Phaser

2 IN/2 OUT dynamic phaser.

Parameter	Range	Description
SENSE	0-100	The input sensitivity
DIR.	UP, DOWN	The direction in which the phase shift frequency moves in response to the input
DECAY	3.34 ms-42.7 s	The speed at which the phase shift frequency moves
OFFSET	0-100	The offset of the frequency at which the phase shift is applied
FB.GAIN	-99 to +99%	The feedback amount
STAGE	2, 4, 6, 8, 10, 12, 14, 16	The number of phase shift stages

OpenDeck

Emulates the tape compression created by two open reel tape recorders (a recording deck and a reproduction deck). You can change the sound quality by adjusting various elements, such as the deck type, tape quality, tape speed, etc.

Parameter	Range	Description
REC DEC	Swss70, Swss78, Swss85, Amer70	Selects the recording deck type.
REC LVL	-96.0 to +18.0 dB	Adjusts the input level of the recording deck. As you raise the level, tape compression is generated, which narrows the dynamic range and distorts the sound.
REC HI	-6.0 to +6.0 dB	Adjusts the high range gain of the recording deck.
REC BIAS	-1.00 to +1.00	Adjusts the bias of the recording deck.
REPR DEC	Swss70, Swss78, Swss85, Amer70	Selects the reproduction deck type.
REPR LVL	-96.0 to +18.0 dB	Adjusts the output level of the reproduction deck.
REPR HI	-6.0 to +6.0 dB	Adjusts the high range gain of the reproduction deck.
REPR LO	-6.0 to +6.0 dB	Adjusts the low range gain of the reproduction deck.
MAKE UP	Off, On	When the REC LVL is moved, REPR LVL will also change, maintaining the relative output level. You can change the amount of distortion without changing the output level.
TP SPEED	15ips, 30ips	Selects the tape speed.
TP KIND	Old, New	Selects the tape type.

Vintage Phaser

This is a model of phaser that provides a high degree of sound-shaping flexibility, and is not intended as a reproduction of any specific model.

Parameter	Range	Description
SPEED	SYNC ON, 0.100Hz to 10.00 Hz	The modulation speed
MANUAL	0.00 to 10.00	The center frequency of the modulation
DEPTH	0.00 to 10.00	The depth of modulation
FEEDBACK	0.00 to 10.00	The feedback amount
COLOR	0.00 to 10.00	Fine tuning of timbre
MODE	1,2	The type of circuit structure that is modeled
STAGE	4, 6, 8, 10, 12, 16	The extent of the circuit that is modeled
FOOT	OFF, ON	Switches the effect on/off

HQ.Pitch

1 IN/2 OUT high-quality pitch shifter.

Parameter	Range	Description
PITCH	-12 to +12 semitones	The amount of pitch change (in semitones)
FINE	-50 to +50 cents	Fine tuning of pitch change (in cents)
DELAY	1.0-1000.0 ms	The pitch change delay time
FB. GAIN	-99 to +99%	The feedback amount
MODE	1-10	The pitch change accuracy
SYNC	OFF, ON	Switches tempo parameter synchronization on/off

*1:  However, the maximum value depends on the TEMPO setting.

Portico 5033

Models an analog 5-band EQ made by Rupert Neve Designs.

Parameter	Range	Description
ALL BYPASS	OFF, ON	Switches EQ bypass on/off. Even in the bypassed state, the signal passes through the input/output transformer and amp circuit.
TRIM	-12.0 to 12.0 dB	The input gain
LF FREQ	30.00 to 300.0 Hz	The center frequency of the LF
LF GAIN	-12.0 to 12.0 dB	The gain of the LF
LMF IN	OFF, ON	Switches the LMF on/off
LMF Q	0.70 to 5.00	The LMF Q
LMF FREQ	50.00 to 400.0 Hz	The center frequency of the LMF
LMF GAIN	-12.0 to 12.0 dB	The gain of the LMF
MF IN	OFF, ON	Switches the MF on/off
MF Q	0.70 to 5.00	The MF Q
MF FREQ	330.0 to 2500 Hz	The center frequency of the MF
MF GAIN	-12.0 to 12.0 dB	The gain of the MF
HMF IN	OFF, ON	Switches the HMF on/off
HMF Q	0.70 to 5.00	The HMF Q
HMF FREQ	1.80k to 16.0k Hz	The center frequency of the HMF
HMF GAIN	-12.0 to 12.0 dB	The gain of the HMF
LF/HF IN	OFF, ON	Switches the LF/HF on/off
HF FREQ	2.50k to 25.0k Hz	The center frequency of the HF
HF GAIN	-12.0 to 12.0 dB	The gain of the HF

EQ-1A

A processor that emulates a vintage EQ that is considered the classic passive EQ.

Parameter	Range	Description
LOW FREQUENCY (LO FREQ *1)	20, 30, 60, 100 Hz	The frequency range of the low-range filter
(LOW) BOOST (LO BOOST *1)	0.0 to 10.0	The amount of amplification of the low-range filter
(LOW) ATTEN (LO ATT *1)	0.0 to 10.0	The amount of attenuation of the low-range filter
HIGH FREQUENCY (HI FREQ *1)	3k, 4k, 5k, 8k, 10k, 12k, 16k Hz	The frequency range of the high-range filter
(HIGH) BOOST (HI BOOST*1)	0.0 to 10.0	The amount of amplification of the high-range filter
(HIGH) BAND WIDTH (BAND WID *1)	0.0 to 10.0	The bandwidth of the high-range filter
(HIGH) ATTEN SEL (HI ATT F *1)	5k, 10k, 20k Hz	The frequency range attenuated with the high-range filter
(HIGH) ATTEN (HI ATT *1)	0.0 to 10.0	The amount of attenuation of the high-range filter
IN	OFF, ON	On/off. If off, the filter section is bypassed but the signal passes through the input/output transformer and amp circuit.

*1. Screen encoder access field display

Dynamic EQ

A newly developed equalizer that dynamically changes EQ gain according to the input signal, allowing you to control the amount of EQ cut or boost like a compressor or expander.

Parameter	Range	Description
BAND ON/OFF	OFF, ON	Switches the corresponding band on/off.
SIDECHAIN CUE	OFF, ON	If this button is on, the sidechain signal linked to the dynamics is sent to the CUE bus for monitoring.
SIDECHAIN LISTEN	OFF, ON	If this button is on, the sidechain signal linked to the dynamics is output to the bus (e.g., STEREO bus or MIX/MATRIX bus) to which the inserted channel is being sent.
FILTER TYPE	Low Shelf, Bell, Hi Shelf	Switches the type of equalizer and sidechain filter.
FREQUENCY (FREQ 1, FREQ 2 *1)	20.0 to 20.0k Hz	The frequency that is controlled by the equalizer and the sidechain filter.
Q (Q 1, Q 2 *1)	15.0 to 0.50	The Q of the equalizer and the sidechain filter.
THRESHOLD (THRESH 1, THRESH 2 *1)	-80.0 to 10.0 dB	The threshold value at which the processing effect begins to apply.
RATIO (RATIO 1, RATIO2 *1)	∞ : 1 to 1 : 1.50	Specifies the ratio of boost/cut for the input signal.
MODE	BELOW, ABOVE	Specifies whether processing operates when the sidechain signal exceeds the threshold value (ABOVE) or when it falls below it (BELOW).
ATTACK/RELEASE	FAST, SLOW, AUTO	The attack time and release time at which compression or boost is applied.

*1. Screen encoder access field display

Dynamic EQ4

This is a two-band dynamic equalizer that has been expanded to feature four bands.

Parameter	Range	Description
BAND ON/OFF	OFF, ON	Switches the corresponding band on/off.
KEY IN SOURCE	INT, EXT	Select main (INT) or external (EXT) as the source for the KEY IN signal used for the corresponding band.
KEY IN CUE	OFF, ON	If this button is on, the sidechain signal is sent to the CUE bus for monitoring.
SHELF ON/OFF	OFF, ON	Switches the type of equalizer and sidechain filter.
FREQUENCY	20.0 to 20.0k Hz	The frequency that is controlled by the equalizer and the sidechain filter.
Q	15.0 to 0.50	The Q of the equalizer and the sidechain filter.
THRESHOLD	-80.0 to 10.0 dB	The threshold value at which the processing effect begins to apply.
RATIO	∞ : 1 to 1 : 1.50	Specifies the ratio of boost/cut for the input signal.
MODE	BELOW, ABOVE	Specifies whether processing operates when the sidechain signal exceeds the threshold value (ABOVE) or when it falls below it (BELOW).
ATTACK/RELEASE	FAST, SLOW, AUTO	The attack time and release time at which compression or boost is applied.

Portico 5043

Models an analog compressor/limiter made by Rupert Neve Designs.

Parameter	Range	Description
IN	OFF, ON	Switches the compressor bypass on/off. When bypassed, the button is unlit. However, even in the bypassed state, the signal passes through the input/output transformer and amp circuit.
FB	OFF, ON	Switches between Feed-Forward and Feed-Back.
THRESHOLD	-50.0 to 0.0 dB	The threshold level
RATIO	1.10 : 1 to 28.9 : 1, LIMIT	The compression ratio
ATTACK	20 to 75 ms	The attack time
RELEASE	100 ms to 2.50 sec	The release time
GAIN	-6.0 to 20.0 dB	The output level

Portico 5045

Models the Primary Source Enhancer made by Rupert Neve Designs.

Parameter	Range	Description
PROCESS ENGAGE	OFF, ON	Switches the enhancement circuit on/off. Even when off, the signal passes through the audio transformer and discrete amp circuit.
RMS/Peak	RMS, Peak	The operation mode for the level detector
TIME CONSTANT	A, B, C, D, E, F	The attack time and release time
THRESHOLD	-42.0 to -12.0 dB	The threshold level
DEPTH	0.0 to -20.0 dB	The amount of signal attenuation below the threshold level

U76

Models a standard vintage compressor/limiter used in a wide variety of situations.

Parameter	Range	Description
INPUT	-96.0 to 0.0 dB	The input level
OUTPUT	-96.0 to 0.0 dB	The output level
ATTACK	5.50 to 0.10 ms	The attack time of the compressor. Fastest when fully turned to the right.
RELEASE	1100.0 to 56.4 ms	The release time of the compressor. Fastest when fully turned to the right.
RATIO	ALL, 4, 8, 12, 20	Switches the compression ratio. Strong when ALL is pressed.
METER	OFF, +4, +8, GR	Switches the meter display

Opt-2A

A processor that emulates a standard vintage model of vacuum tube optical compressor.

Parameter	Range	Description
GAIN	-56.0 dB to 40.0 dB	The output level
PEAK REDUCTION (REDUC *1)	-48.0 dB to 48.0 dB	The amount of gain reduction
RATIO	2.00 to 10.00	The compression ratio
METER SELECT	OUTPUT+10, GAIN REDUCTION, OUTPUT+4	Switches the meter display

*1. Screen encoder access field display

Comp276

Emulates the characteristics of an FET gain reduction compressor commonly used in recording studios. It produces a thick and solid sound that is suitable for drums or bass. Two mono channels can be controlled independently.

Parameter	Range	Description
INPUT 1	-180 to 0 dB	Adjusts the CH1 input level.
OUTPUT 1	-180 to 0 dB	Adjusts the CH1 output gain.
RATIO 1	2:1, 4:1, 8:1, 12:1, 20:1	The CH1 compressor ratio
ATTACK 1	0.022–50.4 ms	The attack time of the CH1 compressor
RELEASE1	10.88–544.22 ms	The release time of the CH1 compressor
MAKE UP1	OFF, ON	Automatically compensates the decrease in the output gain when the CH1 compressor is applied.
SIDE HPF1	OFF, ON	If the CH1 compressor's sidechain HPF is on, the compressor applies less to the low-frequency region, strengthening the low-frequency output.

Comp276S

Emulates the characteristics of an FET gain reduction compressor commonly used in recording studios. It produces a thick and solid sound that is suitable for drums or bass. The L/R channel parameters can be controlled together.

Parameter	Range	Description
INPUT	-180 to 0 dB	Adjusts the input level.
OUTPUT	-180 to 0 dB	Adjusts the output gain.
RATIO	2:1, 4:1, 8:1, 12:1, 20:1	The compressor ratio
ATTACK	0.022–50.4 ms	The attack time of the compressor.
RELEASE	10.88–544.22 ms	The release time of the compressor.
MAKE UP	OFF, ON	Automatically compensates the decrease in the output gain when the compressor is applied.
SIDE HPF	OFF, ON	If the compressor's sidechain HPF is on, the compressor applies less to the low-frequency region, strengthening the low-frequency output.

Buss Comp 369

This compressor emulates a standard bus compressor that is standard in recording studios and broadcasting stations.

Parameter	Range	Description
INPUT ADJUST	-15.0 to +15.0 dB	Adjusts the input gain. However, the output gain changes inversely in tandem with the level of this knob so that the volume remains the same as the pass-through volume. For example if INPUT ADJUST is +5 dB, the input gain is +5 dB and the output gain is -5 dB.
LINK	ON, OFF	Switches the stereo link on/off (stereo only).
METER	IN, GR, OUT	Selects the signal source for the meter (stereo only).
VU	IN, OUT	Selects the signal source for the VU meter (dual only).
COMP IN	ON, OFF	Switches the compressor on/off.
COMP RATIO	1.5:1, 2:1, 3:1, 4:1, 6:1	The compressor ratio
COMP GAIN	0.0 to +20.0 dB	The makeup gain of the compressor
COMP RECOVERY	100 ms, 400 ms, 800 ms, 1500 ms, a1, a2	The release time of the compressor. For a1 (auto 1) and a2 (auto 2), the release time changes automatically. a1: Automatically changes in the range of 100 ms to 2 sec. a2: Automatically changes in the range of 50 ms to 5 sec.
COMP THRESHOLD	-40 to -5 dBFS	The threshold of the compressor
LIMIT IN	ON, OFF	Switches the limiter on/off.
LIMIT ATTACK	FAST, SLOW	The attack time of the limiter. FAST: 2 ms, SLOW: 4 ms
LIMIT RECOVERY	50 ms, 100 ms, 200 ms, 800 ms, a1, a2	The release time of the limiter. For a1 (auto 1) and a2 (auto 2), the release time changes automatically. a1: Automatically changes in the range of 100 ms to 2 sec. a2: Automatically changes in the range of 50 ms to 5 sec.
LIMIT THRESHOLD	-16 to -5 dBFS	The threshold of the limiter

MBC4

This four-band compressor offers intuitive operability.

Parameter	Range	Description
LOW CROSSOVER	20 to 500 Hz	The crossover frequency from the low to mid-low range
MID CROSSOVER	80 to 10 kHz	The crossover frequency from the mid-low to mid-high range
HIGH CROSSOVER	1k to 15 kHz	The crossover frequency from the mid-high to high range
LOW GAIN	-18.0 dB to 12.0 dB	The output gain of the low range
LOW THRESHOLD	-80.0 dB to 0.0 dB	The threshold of the low range
LOW RATIO	1.0:1 to 20.0:1	The compression ratio of the low range
LOW ATTACK	0.1 to 120 ms	The attack time of the low range
LOW RELEASE	5 to 1000 ms	The release time of the low range
LOW COMP IN	ON, OFF	Switches the low-range compressor on/off.
LOW CUE ON	ON, OFF	If this button is on, the low-range output is cued and monitored.
LOW MID GAIN	-18.0 dB to 12.0 dB	The output gain of the mid-low range
LOW MID THRESHOLD	-80.0 dB to 0.0 dB	The threshold of the mid-low range
LOW MID RATIO	1.0:1 to 20.0:1	The compression ratio of the mid-low range
LOW MID ATTACK	0.1 to 120 ms	The attack time of the mid-low range
LOW MID RELEASE	5 to 1000 ms	The release time of the mid-low range
LOW MID COMP IN	ON, OFF	Switches the mid-low range compressor on/off.
LOW MID CUE ON	ON, OFF	If this button is on, the mid-low range output is cued and monitored.
HIGH MID GAIN	-18.0 dB to 12.0 dB	The output gain of the mid-high range
HIGH MID THRESHOLD	-80.0 dB to 0.0 dB	The threshold of the mid-high range
HIGH MID RATIO	1.0:1 to 20.0:1	The compression ratio of the mid-high range
HIGH MID ATTACK	0.1 to 120 ms	The attack time of the mid-high range
HIGH MID RELEASE	5 to 1000 ms	The release time of the mid-high range
HIGH MID COMP IN	ON, OFF	Switches the mid-high range compressor on/off.
HIGH MID CUE ON	ON, OFF	If this button is on, the mid-high range output is cued and monitored.
HIGH GAIN	-18.0 dB to 12.0 dB	The output gain of the high range
HIGH THRESHOLD	-80.0 dB to 0.0 dB	The threshold of the high range
HIGH RATIO	1.0:1 to 20.0:1	The compression ratio of the high range
HIGH ATTACK	0.1 to 120 ms	The attack time of the high range
HIGH RELEASE	5 to 1000 ms	The release time of the high range
HIGH COMP IN	ON, OFF	Switches the high-range compressor on/off.
HIGH CUE ON	ON, OFF	If this button is on, the high-range output is cued and monitored.

Parameter	Range	Description
MAIN GAIN	-18.0 dB to 12.0 dB	Adjusts the gain of the final output signal.
KNEE	HARD, 1, 2, 3, SOFT	Adjusts the knee of the compressor.
FLAVOUR	VCA, OPTO	Switches the type of the compressor between VCA (accurate effects) and OPTO (natural effects).
HARMONICS	ON, OFF	Switches musical harmonics that emulate analog circuitry on/off.
LINK GAIN	—	Adjusts the output gain of the four bands together.
LINK THRESHOLD	—	Adjusts the threshold of the four bands together.
LINK RATIO	—	Adjusts the compression ratio of the four bands together.
LINK ATTACK	—	Adjusts the attack time of the four bands together.
LINK RELEASE	—	Adjusts the release time of the four bands together.

DaNSe

A Dynamic Noise Suppressor with excellent sound quality and operability.

Parameter	Range	Description
TIGHTNESS	50 to 2000ms	The release time
LOW_FREQUENCY	20 Hz to 5.00 kHz	The lower frequency limit of the noise suppression band
HIGH_FREQUENCY	80 Hz to 20.00 kHz	The upper frequency limit of the noise suppression band
LINK	—	The GAIN 1-6 simultaneous modulation knob
THRESHOLD	-80.0 to 0.0 dB	The threshold level
GAIN 1	-24.0 to 0.0 dB	The maximum amount of gain reduction in BAND1
GAIN 2	-24.0 to 0.0 dB	The maximum amount of gain reduction in BAND2
GAIN 3	-24.0 to 0.0 dB	The maximum amount of gain reduction in BAND3
GAIN 4	-24.0 to 0.0 dB	The maximum amount of gain reduction in BAND4
GAIN 5	-24.0 to 0.0 dB	The maximum amount of gain reduction in BAND5
GAIN 6	-24.0 to 0.0 dB	The maximum amount of gain reduction in BAND6
LEARN	ON, OFF	The LEARN (THRESHOLD and GAIN 1-6 automatic adjustment) start button*1
REVERT	—	The REVERT (restoration of last LEARN parameter) start button

*1. Since the internal signal processing parameters are also adjusted automatically, LEARN in different environments may have different effects even if all the displayed parameters are configured the same. If a scene recall or library recall is executed without using Recall Safe for parameters during LEARN, the LEARN may fail.

Appendix

General specifications

Mixing capacity		DM7: 120 Inputs, 48 MIX + 12 MATRIX + 2 STEREO
		DM7 Compact: 72 Inputs, 48 MIX + 12 MATRIX + 2 STEREO
Sampling frequency	External clock frequency range	48 kHz / 96 kHz \pm 200 ppm
	Internal clock frequency	48 kHz / 96 kHz
Signal delay		Less than 1.5 ms, INPUT to OMNI OUT @Fs=96 kHz
Screens		DM7: 12.1" multi-touch screen \times 2, 7" multi-touch screen \times 1
		DM7 Compact: 12.1" multi-touch screen \times 1, 7" multi-touch screen \times 1
Fader		DM7: 100 mm touch-sensitive motorized fader \times 28
		DM7 Compact: 100 mm touch-sensitive motorized fader \times 16
Power requirements		100-240 V, 50/60 Hz
Power consumption		240 W
Dimensions (W \times H \times D)		DM7: 793 mm \times 324 mm \times 564 mm (including the rubber feet)
		DM7 Compact: 468 mm \times 324 mm \times 564 mm (including the rubber feet)
Weight		DM7: 23.5 kg
		DM7 Compact: 16.5 kg
NC value *1	Fan Speed Low	NC=20
	Fan Speed High	NC=30
Operating temperature range		Min: 0°C, Max: 40°C
Storage temperature range		Min: -20°C, Max: 60°C
Accessories		Owner's Manual, AC power cord \times 2, Dust cover, Cable hook, Nuendo Live and VST Rack Elements Download Information leaflet
Optional items		DM7: PY cards, DM7 Control (CTL-DM7) DM7 Compact: PY cards, DM7 Control (CTL-DM7), Rack Mount Kit RK1

*1. Measured 30 cm horizontally away and vertically up from the unit (front pad)

Audio characteristics

During measurement, all faders were nominal. The output impedance of the signal generator was 150Ω. The output load impedance was either 600Ω (set with the Output Load Impedance button on the OMNI OUT screen).

Frequency characteristics

@20Hz-20kHz, reference to the nominal output level @1kHz

Input	Output	RL	Conditions	Min.	Typ.	Max.	Unit
INPUT 1-32 (DM7 Compact INPUT 1-16)	OMNI OUT 1-16	600Ω	GAIN: +66dB	-1.5	0.0	0.5	dB

Total harmonic distortion

Input	Output	RL	Conditions	Min.	Typ.	Max.	Unit
INPUT 1-32 (DM7 Compact INPUT 1-16)	OMNI OUT 1-16	600Ω	+4dBu @20Hz-20k Hz, GAIN: -6dB			0.05	%
INPUT 1-32 (DM7 Compact INPUT 1-16)	PHONES	40Ω	50mW @1kHz, PHONES LEVEL: Max.			0.15	%

*1. Total harmonic distortion was measured using an 80 kHz, 18 dB/octave low pass filter.

Hum & noise *2

Input	Output	RL	Conditions	Min.	Typ.	Max.	Unit
INPUT 1-32 (DM7 Compact INPUT 1-16)	OMNI OUT 1-16	600Ω	Rs=150Ω, GAIN: +66dB		-128 EIN *1		dBu
					-62		
INPUT 1-32 (DM7 Compact INPUT 1-16)	OMNI OUT 1-16	600Ω	Rs=150Ω, GAIN: -6dB		-88	-85	dBu
-	OMNI OUT 1-16	600Ω	Residual output noise; Output channel is off.			-92	dBu
-	PHONES	40Ω	Residual output noise; PHONES LEVEL: Min.			-94	dBu

*1. EIN is Equivalent Input Noise.

*2. Hum & noise levels were measured using an A-weight filter.

Dynamic range

Input	Output	RL	Conditions	Min.	Typ.	Max.	Unit
INPUT 1-32 (DM7 Compact INPUT 1-16)	OMNI OUT 1-16	600Ω	AD + DA, GAIN: -6dB		112		dB
-	OMNI OUT 1-16	600Ω	DA Converter		117		dB

*1. Dynamic range was measured using an A-weight filter.

Crosstalk

Input	Output	Conditions	Min.	Typ.	Max.	Unit
INPUT n	OMNI IN (n-1) or (n+1)	INPUT 1-32 (DM7 Compact INPUT 1-16), adjacent inputs, GAIN: -6dB			-100	dB
INPUT n	OMNI OUT (n-1) or (n+1)	Input to output			-100	dB

*1. Crosstalk was measured using a 22 kHz, 30 dB/octave low pass filter.

Analog input standards

Input jack	Gain	Input impedance	Source impedance	Input level: Sensitivity *1	Input level: Specified level	Input level: Maximum non-clip level	Connector	Balanced / Un-balanced
INPUT 1-32 (DM7 Compact INPUT 1-16)	+66dB	7.5k Ω	50-600 Ω Mics & 600 Ω Lines	-82dBu (61.6 μ V)	-62dBu (0.616mV)	-42dBu (6.16mV)	XLR 3-hole chassis *2	Balanced
	-6dB			-10dBu (245mV)	+10dBu (2.45V)	+30dBu (24.5V)		

*1. Sensitivity is the input level needed to produce +4 dBu (1.23 V) or the specified level when all faders and level controls are set to maximum.

*2. The connectors are balanced type (1=GND, 2=HOT, 3=COLD).

*3. 0 dBu = 0.775 Vrms.

*4. The INPUT 1-32 jacks have +48 VDC (phantom power) that can be set from the main unit's software for each terminal.

Analog output standards

Output jack	Output impedance	Load impedance	Output level: Specified level	Output level: Maximum non-clip level	Connector	Balanced / Unbalanced
OUTPUT 1-16	75Ω	600Ω Lines	-+4dBu (1.23 V)	+24dBu (12.3V)	XLR 3-pin chassis *1	Balanced
PHONES	10Ω	8Ω Phones	60mW *2	60mW	Stereo Phone Socket (TRS) *4	Unbalanced
		40Ω Phones	60mW *3	100mW		

*1. The connectors are balanced type (1=GND, 2=HOT, 3=COLD).

*2. This is the value when the PHONES LEVEL knob is set to 12dB below the maximum position.

*3. This is the value when the PHONES LEVEL knob is set to 10dB below the maximum position.

*4. The connectors are unbalanced type (Tip = LEFT, Ring = RIGHT, Sleeve = GND).

*5. 0 dBu = 0.775 Vrms.

Digital I/O standards

Jack	Format	Data length	Level	Audio	Connector	Balanced / Unbalanced
Dante Primary, Secondary	Dante	24bit / 32bit	1000BASE-T	144ch input 144ch output	etherCON CAT5e *1*2	-
USB TO HOST	USB2.0	32-bit	USB2.0	18ch input 18ch output	USB C chassis	-
AES/EBU IN 1/2,3/4 (DM7 only) *3	AES/EBU	24-bit	RS422	2ch input	XLR 3-hole chassis *4	Balanced
AES/EBU OUT 1/2,3/4 *3 (DM7 Compact AES/EBU OUT 1/2)	AES/EBU	24-bit	RS422	2ch output	XLR 3-pin chassis *4	Balanced

*1. The connection cables are CAT5e or higher.

*2. STP is recommended for the connection cables.

*3. Built-in sampling rate converter (DM7 only), Supported input/output frequencies: 40-102kHz

*4. The connectors are balanced type (1=GND, 2=HOT, 3=COLD).

Control I/O standards

Jack	Format	Level	Connector	Balanced / Unbalanced
WORD CLOCK IN	-	TTL/75Ω terminated	BNC	-
WORD CLOCK OUT	-	TTL/75Ω	BNC	-
TC IN	SMPTE	0.3Vpp(min)/ 10.0Vpp(max), 10kΩ	XLR 3-hole chassis *1	Balanced
USB *2	USB2.0/1.1	USB2.0/1.1	USB A chassis	-
NETWORK	IEEE802.3	10BASE-T/ 100BASE-TX	RJ-45 CAT5 *3*4	-
GPI *5	-	-	D-SUB 15-hole chassis	-

*1. The connectors are balanced type (1=GND, 2=HOT, 3=COLD).

*2. The USB port can supply up to 1A for each jack.

*3. The connection cables are CAT5 or higher.

*4. STP is recommended for the connection cables.

- *5.
- Input pins CH 1-5: TTL level (input voltage 0–5V) with internal 47kΩ pull-up resistor
 - Output pins CH 1-5: Open collector output (maximum supply voltage 12V, maximum inflowing current/pin 75mA)
 - Power supply pins: Output voltage 5V, maximum output current 300mA

Pin assignment table

GPI

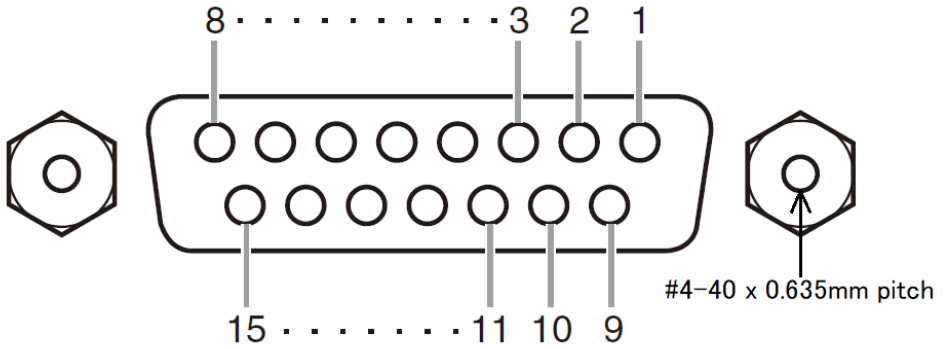

Pin	Signal Name	Pin	Signal Name
1	GPO1	9	GPO2
2	GPO3	10	GPO4
3	GPO5	11	GND
4	GND	12	GND
5	+5V	13	+5V
6	GPI1	14	GPI2
7	GPI3	15	GPI4
8	GPI5		

Troubleshooting

Refer also to the Yamaha Pro Audio website that provides a FAQ (a list of frequently asked questions, with answers). <http://www.yamahaproaudio.com/>.

Problem & Cause	Solution
No sound	
Incorrect input source settings for input channels.	Check the Input Patch screen.
The [ON] key on the relevant channel(s) is turned OFF.	Turn it ON.
The fader or volume of the relevant channel(s) is off.	Raise the fader or volume.
Phantom power is not being supplied to the condenser mike.	Turn On the +48V Active button from the GENERAL screen and then turn ON the +48V button from the INPUT screen (I/O DEVICE screen : HA or OMNI IN screen).
Mute is ON.	Check mute group assignments and the settings for mute group control.
A gate is exceeded.	Check the settings on the DYN1 screen.
The volume is low.	
Incorrect gain setting.	Adjust the gain on the INPUT screen (I/O DEVICE screen : HA or OMNI IN screen).
Noise gate and/or compressor exceeded.	Check the settings on the DYN1 and/or DYN2 screen.
Sound is distorted	
Incorrect gain setting.	Adjust the gain on the INPUT screen (I/O DEVICE screen : HA or OMNI IN screen).
Input level is too high.	Lower the volume of the input source.
Others	
Subnet mask of DM7 series does not match that of the computer.	Make the IP addresses the same via the Static IP mode. If using the DHCP mode, use a router with a DHCP server function and enable the DHCP function on the computer.
There is a discrepancy in the movement of motorized faders.	Turn on the console while holding down the Home key on the top panel. Then run calibration of the faders from the MAINTENANCE screen.
In the LCD display, there are some black points (unlit) or white points (always lit).	Unfortunately, this is a common characteristic of TFT-LCDs.

MIDI Implementation Chart

Function...		Transmitted	Recognized	Remarks
Basic Channel	Default	1	1-16	Memorized
	Changed	1-16	1-16	
Mode	Default	X	1, 3	Memorized
	Messages	X	X	
	Altered	*****	X	
Note Number	True Voice	0-127	X	
		X	X	
Velocity	Note On	O 9nH, v=0,127	X	Effect Control
	Note Off	O v=0	X	
After Touch	Key's	X	X	
	Ch's	X	X	
Pitch Bend		X	X	
Control Change	0,32	O	O	Bank Select Data Entry NRPN LSB,MSB Assignable Cntrl
	6,38	O	O	
	98,99	X	X	
	1-31,33-95, 102-119	O	O	
Prog Change	:True#	O 0-127 *****	O 0-127 1.00-499.99	Assignable
System Exclusive		X	X	MMC, MTC
Common	:Song Pos.	X	X	Recorder Control
	:Song Sel.	X	X	
	:Tune	X	X	
System Real Time	:Clock	X	O	Effect Control
	:Commands	X	X	
Aux Messages	:All Sound Off	X	X	
	:Reset All Cntrls	X	X	
	:Local ON/OFF	X	X	
	:All Notes OFF	X	X	
	:Active Sense	X	O	
	:Reset	X	O	
Notes				

Yamaha Pro Audio global website
<https://www.yamahaproaudio.com/>
Yamaha Downloads
<https://download.yamaha.com/>