

# YAMAHA KA-M555

*Natural Sound Stereo Cassette Amplifier*

*Amplificateur-cassette stéréo de la série "Natural Sound"*

*Natural Sound Stereo-Kassettendeck/Verstärker*

*Natural Sound stereo kassettbandspelare/förstärkare*

*Amplificatore a cassette stereo a suono naturale*

CENTER

OWNER'S MANUAL

MODE D'EMPLOI

BEDIENUNGSANLEITUNG

BRUKSANVISNING

MANUALE DELL'UTENTE

Remote control transmitter (RS-AV5)  
 Émetteur de télécommande (RS-AV5)  
 Fernbedienungsgeber (RV-AV5)  
 Fjärrkontroll (RS-AV5)  
 Trasmittente del telecomando (RS-AV5)

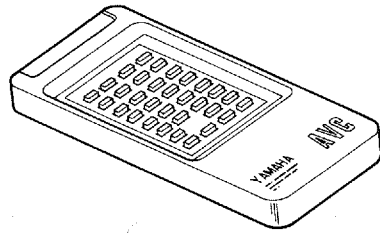

Two "AA" (R06) batteries  
 Deux piles "AA" (R06)  
 Zwei Batterien der Größe "AA" (R06)  
 Två "AA" (R06) batterier  
 2 batterie "AA" (R06)

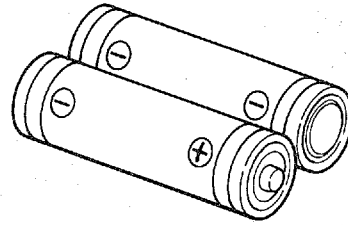

Audio connection cord  
 Câble de raccordement audio  
 Audio-Anschlußkabel  
 Ljudkabel  
 Cavo di collegamento audio

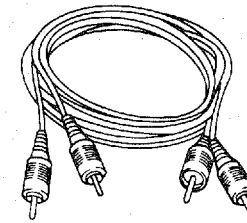

10-pin CD connection cord  
 Câble de raccordement CD à 10 broches  
 10-pol. CD-Anschlußkabel  
 10-polig CD-kabel  
 Cavo di collegamento per lettori CD a 10 piedini

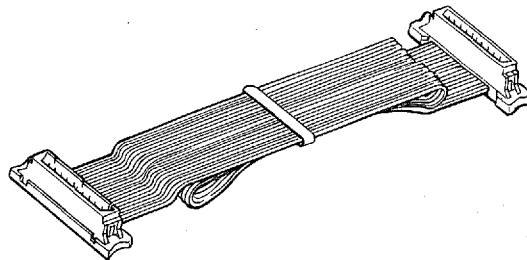

5-pin tuner connection cord  
 Câble de raccordement du syntoniseur à 5 broches  
 5-pol. Tuner-Anschlußkabel  
 5-polig tuner-kabel  
 Cavo di collegamento per sintonizzatori a 5 piedini.

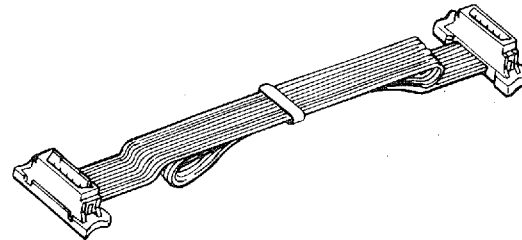

2

Turntable P-M555  
 Platine tourne-disque P-M555  
 Plattenspieler P-M555  
 Skivspelare P-M555  
 Giradischi P-M555

Compact disc player CD-M555  
 Lecteur de disque audionumérique CD-M555  
 CD-Spieler CD-M555  
 Compact Disc-spelare CD-M555  
 Lettore CD CD-M555

Tuner T-M555L or T-M555  
 Syntoniseur T-M555L ou T-M555  
 Tuner T-M555L oder T-M555  
 Tuner T-M555L eller T-M555  
 Sintonizzatore T-M555L o T-M555

Right-channel front speaker  
 Haut-parleur avant du canal de droite  
 Vorderer Lautsprecher, rechter Kanal  
 Höger kanals främre högtalare  
 Diffusore anteriore destro

Left-channel front speaker  
 Haut-parleur avant du canal de gauche  
 Vorderer Lautsprecher, linker Kanal  
 Vänster kanals främre högtalare  
 Diffusore anteriore sinistro

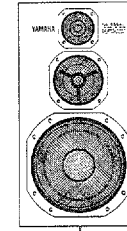
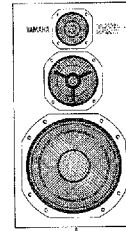
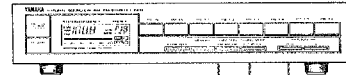
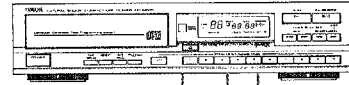
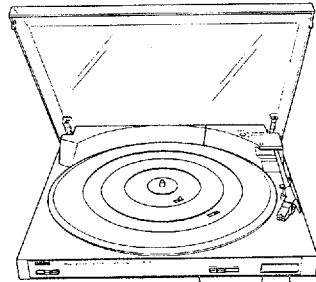

Graphic equalizer EQ-M555  
 Egaliseur graphique EQ-M555  
 Graphic Equalizer EQ-M555  
 Grafisk ekvalisator EQ-M555  
 Equalizzatore grafico EQ-M555

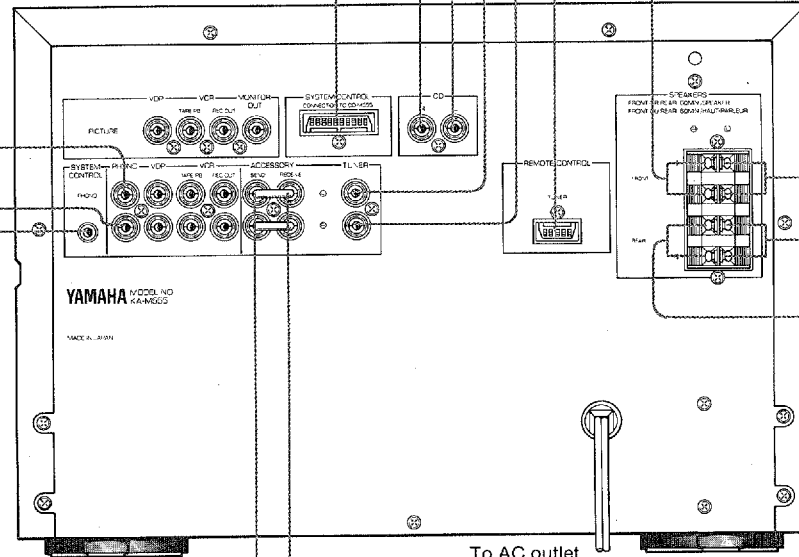
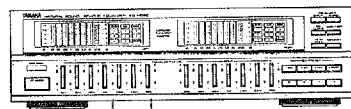

Cassette amplifier KA-M555  
 Amplificateur-cassette KA-M555  
 Kassettendeck/Verstärker KA-M555  
 Kassettbandspelare/förstärkare KA-M555  
 Amplificatore a cassette KA-M555

To AC outlet  
 Vers la prises CA  
 Zur Netzsteckdose  
 Till nätuttag  
 Ad una presa di c.a.

Right-channel rear speaker  
 Haut-parleur arrière du canal de droite  
 Hinterer Lautsprecher, rechter Kanal  
 Höger kanals bakre högtalare  
 Diffusore posteriore destro

Left-channel rear speaker  
 Haut-parleur arrière du canal de gauche  
 Hinterer Lautsprecher, linker Kanal  
 Vänster kanals bakre högtalare  
 Diffusore posteriore sinistro

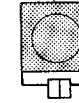

3

Insert the speaker cord while pressing the lever down, then release it.  
 Insérer le câble de haut-parleur en pressant sur le levier, puis le relâcher.  
 Den Hebel nach unten drücken, das Kabel einführen und den Hebel wieder loslassen.  
 Skjut in högtalarledningens ända medan knappen trycks ned och släpp sedan knappen.  
 Inserite le estremità dei cavi tenendo premute le linguette dei terminali, lasciandole quindi andare per bloccarli.

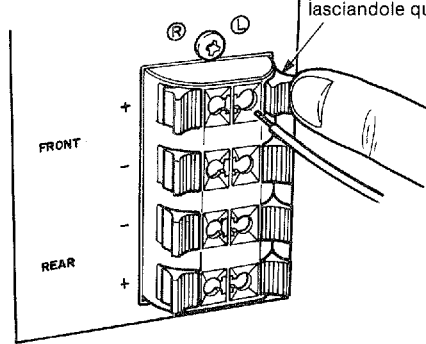

4

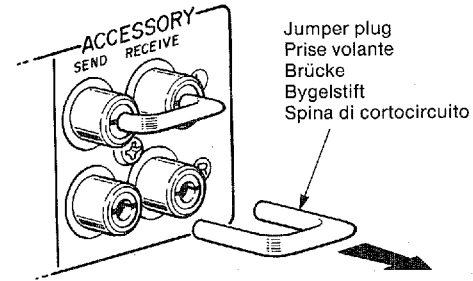

5

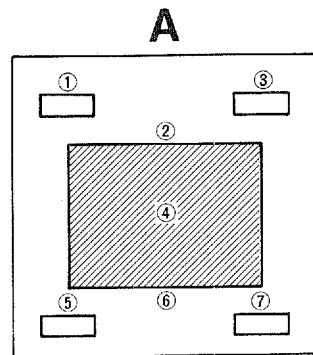

LEFT (Front)  
 GAUCHE (avant)  
 ① LINKS (vorne)  
 VÄNSTER (främre)  
 SINISTRA (davanti)  
 FRONT  
 AVANT  
 ② VORNE  
 FRÄMRE  
 ANTERIORE

RIGHT (Front)  
 DROIT (avant)  
 ③ RECHTS (vorne)  
 HÖGER (främre)  
 DESTRA (davanti)

Listening Area  
 Zone d'écoute  
 ④ Hörbereich  
 Lyssningsområde  
 Area di ascolto

LEFT (Rear)  
 GAUCHE (arrière)  
 ⑤ LINKS (hinten)  
 VÄNSTER (bakre)  
 SINISTRA (dietro)

SURROUND  
 ENVIRONNEMENT  
 ⑥ RAUMKLANG  
 KRINGLJUD  
 CIRCONDAMENTO

RIGHT (Rear)  
 DROIT (arrière)  
 ⑦ RECHTS (hinten)  
 HÖGER (bakre)  
 DESTRA (dietro)

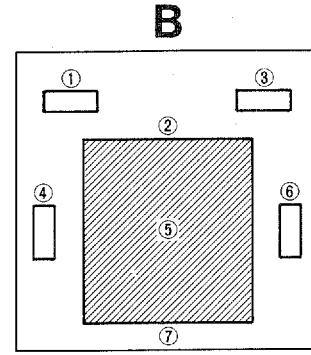

LEFT (Front)  
 GAUCHE (avant)  
 ① LINKS (vorne)  
 VÄNSTER (främre)  
 SINISTRA (davanti)

FRONT  
 AVANT  
 ② VORNE  
 FRÄMRE  
 ANTERIORE

RIGHT (Front)  
 DROIT (avant)  
 ③ RECHTS (vorne)  
 HÖGER (främre)  
 DESTRA (davanti)

LEFT (side)  
 GAUCHE (côté)  
 ④ LINKS (Seite)  
 VÄNSTER (sida)  
 SINISTRA (lato)

Listening Area  
 Zone d'écoute  
 ⑤ Hörbereich  
 Lyssningsområde  
 Area di ascolto

RIGHT (Side)  
 DROIT (côté)  
 ⑥ RECHTS (Seite)  
 HÖGER (sida)  
 DESTRA (lato)

SURROUND  
 ENVIRONNEMENT  
 ⑦ RAUMKLANG  
 KRINGLJUD  
 CIRCONDAMENTO

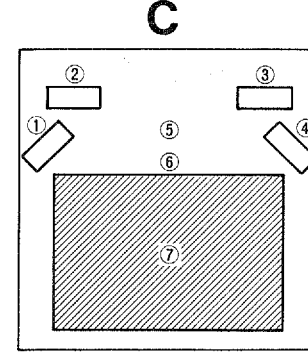

LEFT (Surround)  
 GAUCHE (environnement)  
 ① LINKS (Raumklang)  
 VÄNSTER (kringljud)  
 SINISTRA (circondamento)

LEFT (Front)  
 GAUCHE (avant)  
 ② LINKS (vorne)  
 VÄNSTER (främre)  
 SINISTRA (davanti)

RIGHT (Front)  
 DROIT (avant)  
 ③ RECHTS (vorne)  
 HÖGER (främre)  
 DESTRA (davanti)

RIGHT (Surround)  
 DROIT (environnement)  
 ④ RECHTS (Raumklang)  
 HÖGER (kringljud)  
 DESTRA (circondamento)

FRONT  
 AVANT  
 ⑤ VORNE  
 FRÄMRE  
 DAVANTI

SURROUND  
 ENVIRONNEMENT  
 ⑥ RAUMKLANG  
 KRINGLJUD  
 CIRCONDAMENTO

Listening Area  
 Zone d'écoute  
 ⑦ Hörbereich  
 Lyssningsområde  
 Area di ascolto

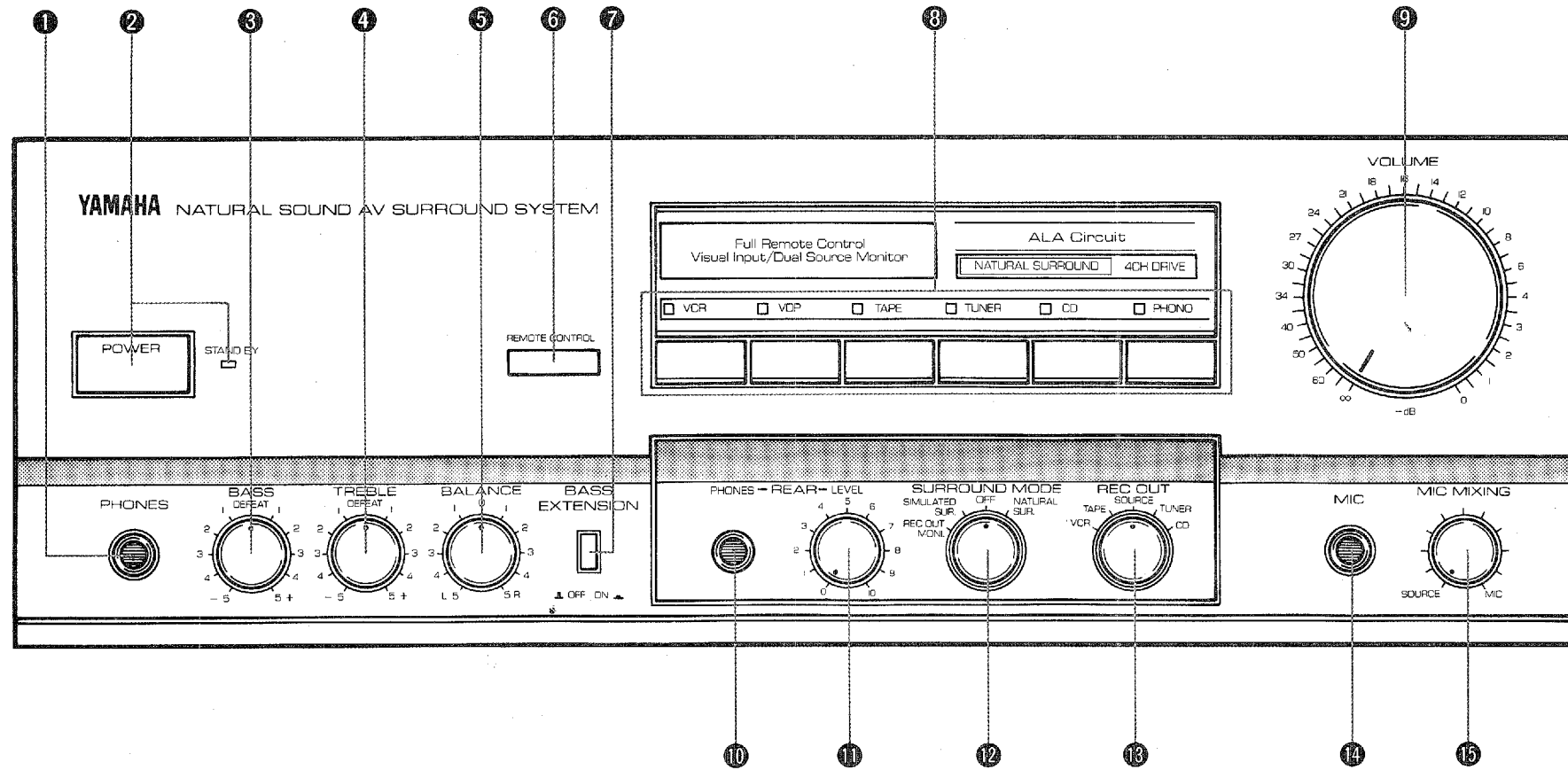

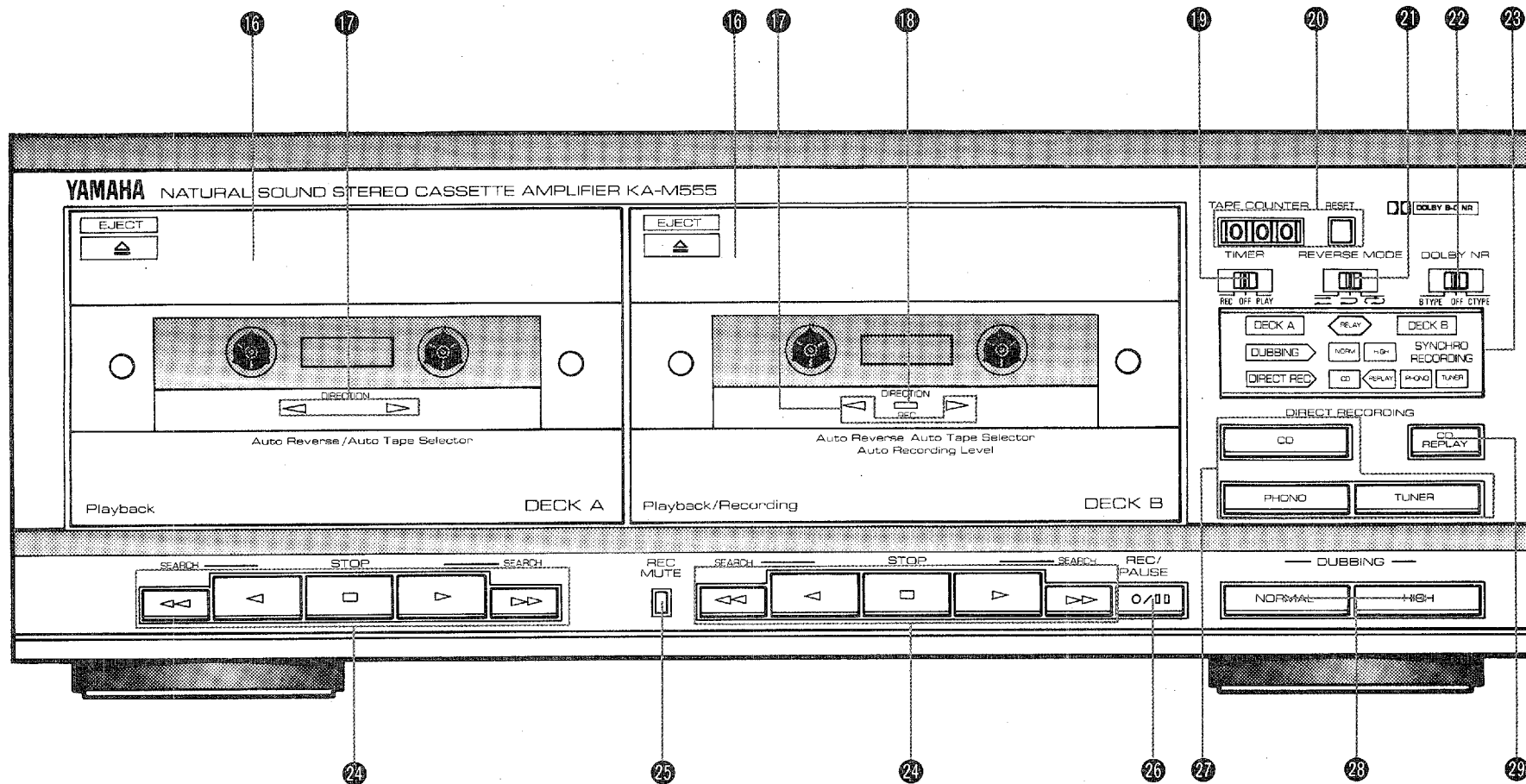

- ⑳ Display window
- ㉑ Fenêtre d'affichage
- ㉒ Display
- ㉓ Indikeringsfönster
- ㉔ Display

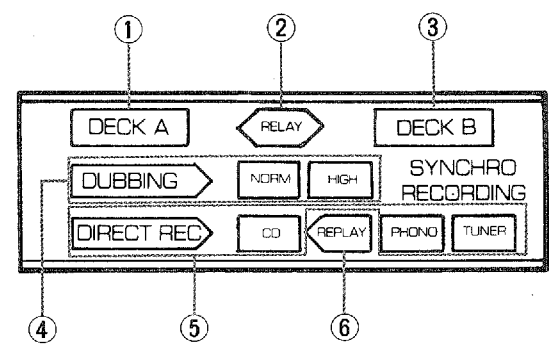

8

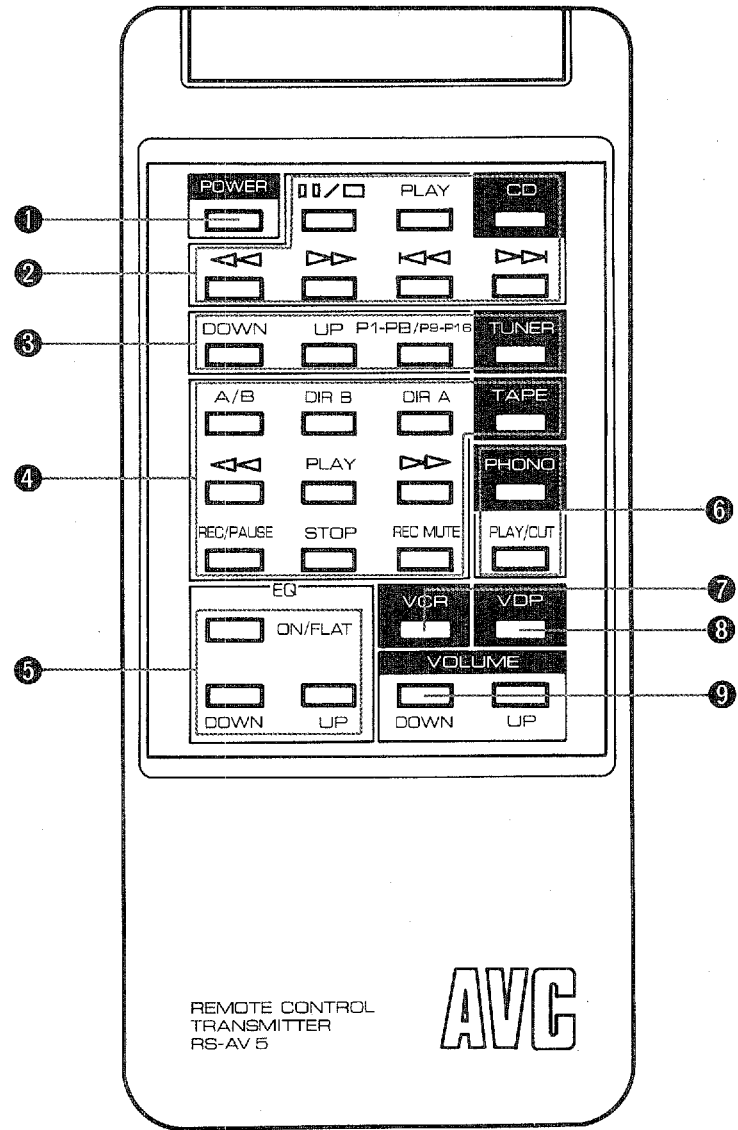

9

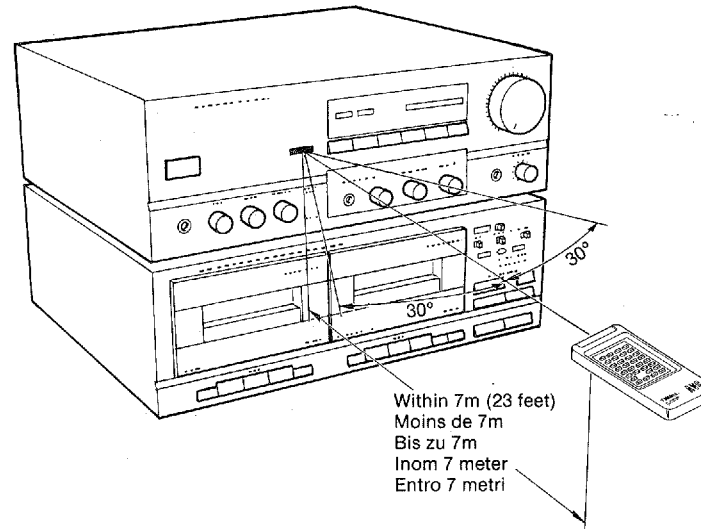

10

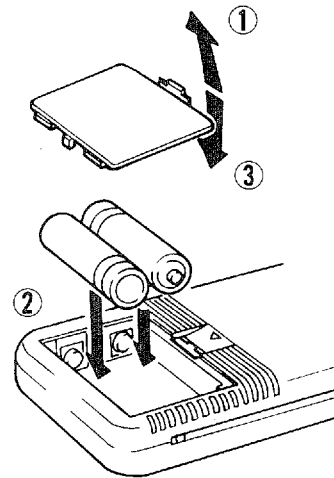

● Thank you for purchasing the YAMAHA KA-M555 stereo cassette amplifier.

---

**CAUTION: READ THIS BEFORE OPERATING YOUR KA-M555.**

---

- 1.** To ensure the finest performance, please read this manual carefully. Keep it in a safe place for future reference.
- 2.** Install your unit in a cool, dry, clean place — away from windows, heat sources, and too much vibration, dust, moisture or cold. Avoid sources of hum (transformers, motors). To prevent fire or electrical shock, do not expose to rain and water.
- 3.** Never open the cabinet. If a foreign object drops into the set, contact your dealer.
- 4.** Do not use force on switches, knobs or cords. When moving the unit, first disconnect the power plug and the cords connected to other equipment. Never pull the cord itself.
- 5.** Always set the volume control to “-∞” while lowering the tonearm to play a record; turn the volume up after stylus-record contact.
- 6.** Do not attempt to clean the unit with chemical solvents; this might damage the finish. Use a clean, dry cloth.
- 7.** Be sure to read the “Troubleshooting” section on common operating errors before concluding that your unit is faulty.
- 8.** Grounding or polarization — The precautions should be taken so that the grounding or polarization of the unit is not defeated.
- 9.** Do not connect audio equipment to the AC outlet on the rear panel if that equipment requires more power than the outlets are rated to provide.
- 10.** If your unit has a voltage selector (General model only), check that it is set to your local voltage before you plug it in. If not properly set, reset the switch according to your supply voltage.
- 11.** Never allow metallic items (e.g. screwdrivers, tools, etc.) to come near the record/playback head assembly. Doing so may not only scratch or damage the head’s mirror-smooth finish, it may change the magnetic characteristics of the heads, causing a deterioration in reproduction performance quality.
- 12.** Although the record/playback head used in this unit is a high quality Permalloy head with outstanding reproduction characteristics, it can become dirty through the use of old tapes or from dust accumulation over time. This can have a serious effect on reproduction quality. Clean the heads regularly with one of the commonly available head cleaners or with cleaning solutions as explained later in this manual.

**WARNING**

TO PREVENT FIRE OR ELECTRIC SHOCK, DO NOT EXPOSE THIS APPLIANCE TO RAIN OR MOISTURE.

**CAUTION (FOR CANADA MODEL)**

TO PREVENT ELECTRIC SHOCK DO NOT USE THIS (POLARIZED) PLUG WITH AN EXTENSION CORD RECEPTACLE OR OTHER OUTLET UNLESS THE BLADES CAN BE FULLY INSERTED TO PREVENT BLADE EXPOSURE.

**Special Instructions for U.K. Model**

**IMPORTANT**

The wires in the mains lead are coloured in accordance with the following code:

Blue: NEUTRAL

Brown: LIVE

As the colours of the wires in the mains lead of this apparatus may not correspond with the coloured markings identifying the terminals in your plug, proceed as follows. The wire which is coloured BLUE must be connected to the terminal which is marked with the letter N or coloured BLACK. The wire which is coloured BROWN must be connected to the terminals which is marked with the letter L or coloured RED.



## SUPPLIED ACCESSORIES

(See Fig. 1.)

Check that all of the following accessories are correctly included in the package.

- Remoto control transmitter (RS-AV5)
- Two "AA" (R06) batteries
- Audio connection cord
- 10-pin CD connection cord
- 5-pin tuner connection cords

## CONNECTION

### ■ CONNECTION OF SYSTEM COMPONENTS (See Fig. 2.)

Cautions on making connections:

1. Be sure to turn off the power to all the components before making the connections.
2. Make sure the left-channel (L) and right-channel (R) connection cords are connected correctly.
3. Be sure to plug in the power cords only after all other connections are completed.

#### ● Tuner connections

1. Using the tuner connection cord supplied, connect the TUNER REMOTE CONTROL connector on the rear panel of the cassette amplifier to the REMOTE CONTROL connector of the tuner.  
Make sure that the tuner connectors are inserted into the connectors with the correct up/down direction.
2. Connect the output jacks of the tuner to the TUNER jacks.

#### ● CD player connections

1. Using the supplied CD connection cord, connect the SYSTEM CONTROL connector on the rear panel of the cassette amplifier to the SYSTEM CONTROL connector of the CD player. Make sure that the CD connectors are inserted into the connectors with the correct up/down direction.
2. Using the audio connection cord connect the CD jacks on the rear panel of the cassette amplifier to the output jacks of the CD player.

#### ● Speakers (See Fig. 3.)

Connect the SPEAKERS terminals to your front and rear speakers with the proper gauge of wire, cut to be as short as possible. Press the speaker wire terminal tabs down, then insert the bare wires and secure them by releasing the tabs. If these connections are faulty, no sound will be heard from the speakers. Make sure that the polarity of the speaker wires is correct, that is, that the + and - markings are observed. If these wires are reversed, the sound will be unnatural and will lack bass (out of phase). Do not coil up the excess speaker wire, or bundle the speaker wires with the power cords.

#### ● AC OUTLET

The power to the SWITCHED OUTLET is controlled by the amplifier's POWER switch. It will supply power to any unit that is connected here whenever the amplifier is turned on.

Europe and Canada models provide two SWITCHED OUTLETS, and the total power consumption of connected units cannot be more than 200 watts.

General, U.K. and Australia models provide one SWITCHED OUTLET, and the power consumption of connected unit cannot be more than 200 watts.

The power to the UNSWITCHED OUTLET is not controlled by the POWER switch. It will always supply power to the unit connected to this outlet. Only General model provides one UNSWITCHED OUTLET, and the power consumption of connected unit cannot be more than 200 watts.

#### ● Turntable connections

1. Connect the signal cord from the turntable to the PHONO jacks on the rear panel of the cassette deck amplifier.
2. Using the system cord supplied with P-M555, connect the system control jack of the turntable to the PHONO SYSTEM CONTROL jack on the rear panel of the cassette deck amplifier.

#### ● Graphic equalizer connections (See Fig. 4.)

1. Remove the two jumper plugs inserted into the ACCESSORY jacks on the rear panel of the cassette amplifier.  
Retain them for the future use.
2. Using the audio connection cord supplied with the graphic equalizer, connect the ACCESSORY SEND jacks to the line in jacks of the graphic equalizer.
3. Using the audio connection cord supplied with the graphic equalizer, connect the ACCESSORY RECEIVE jacks to the line out jacks of the graphic equalizer.

#### ■ CONNECTION OF OTHER COMPONENTS

##### ● Video disc player connections

1. Connect the Video Disc Player (VDP) AUDIO IN jacks on the rear panel of the cassette amplifier to the audio out jacks of the optional video disc player, using an audio connection cord (optional).
2. Connect the PICTURE VDP jack on the rear panel of the cassette amplifier to the video out jack of the optional video disc player, using a monaural-type video connection cord (optional).

##### ● VCR connections

1. Using stereo-type audio connection cord (optional), connect the VCR TAPE PB jacks on the rear panel of the cassette amplifier to the audio out jacks of the optional VCR.  
Also connect the VCR REC OUT jacks on the rear panel of the cassette amplifier to the audio in jacks of the optional VCR, in the same way.
2. Using monaural-type video connection cord (optional), connect the PICTURE VCR TAPE PB jack on the rear panel of the cassette amplifier to the video out jack of the optional VCR. Also connect the VCR REC OUT jack on the rear panel of the cassette amplifier to the video in jack of the VCR, in the same way.

##### ● TV monitor connection

This unit allows a connection to an optionally available TV receiver or TV monitor having a video input jack.

Using a monaural-type video connection cord (optional), connect the MONITOR OUT jack of the cassette amplifier to the video input jack of the TV receiver (TV monitor).

#### ■ SPEAKER CONFIGURATION EXAMPLES (See Fig. 5.)

##### Installation example A:

When the simulation of a concert hall or theater is required:

##### Installation example B:

Dynamic sound field with full "liveness":

##### Installation example C:

Wider listening area; suitable for viewing movies:

## CONTROLS AND FUNCTIONS

### AMPLIFIER SECTION (See Fig. 6.)

#### ① PHONES jack

When optional stereo headphones are connected to this jack, the front sound from the source selected by the input selector can be heard with the headphones, while the sound from the speakers is automatically cut.

#### ② POWER switch

Press this switch to turn the power ON. Pressing it again turns the power OFF. In the Europe, U.K. and Australia models, a STAND BY indicator is provided. This indicator lights when the power cord is connected to an AC outlet.

#### ③ BASS control

This control is used to control the low frequency response. Set this control to the DEFEAT position for flat response. Turn the control clockwise to boost the low frequency response and turn it counterclockwise to attenuate it.

\* This control has no effect on the rear-channel sound.

#### ④ TREBLE control

This control is used to control the high frequency response. Set this control to the DEFEAT position for flat response. Turn the control clockwise to boost the high frequency response and turn it counterclockwise to attenuate it.

\* This control has no effect on the rear-channel sound.

#### ⑤ BALANCE control

This control is used to adjust the volume level balance between the left-channel and right-channel front speakers. Turn this control clockwise (toward R) to decrease the volume of the left-channel sound, and turn it counterclockwise (toward L) to decrease the volume of the right-channel sound.

\* This control has no effect on the rear-channel sound.

#### ⑥ REMOTE CONTROL sensor

This sensor receives signals transmitted from the supplied remote control transmitter.

#### ⑦ BASS EXTENSION switch

Press this switch ON to emphasize the lower frequencies (especially for frequencies around 80 Hz).

\* This switch has no effect on the rear-channel sound.

#### ⑧ Input selectors and indicators

Select the source to be listened to and/or watched with these switches (VCR, Cassette Deck, CD, Turntable, etc.). When any of these switches is pressed ON, the corresponding indicator located above the switch will light.

#### ⑨ VOLUME control and indicator

This control is used to adjust the volume level. Turn this control clockwise to increase the volume level, and turn it counterclockwise to decrease the volume. At this time, the MIC MIXING control should be turned fully counterclockwise (toward SOURCE). When the rear-channel speakers are connected to this unit, this control controls the overall volume level.

#### ⑩ REAR PHONES jack

With stereo headphones connected to this jack, the rear-channel sound from the source selected by the input selector can be heard with the headphones. When the SURROUND MODE selector is set to the REC OUT MONI. position, the sound from the source selected by the REC OUT selector will be heard.

#### ⑪ REAR LEVEL control

This control is used to adjust the volume level of the rear speakers, or the headphones connected to the REAR PHONES jack. Turn this control clockwise to increase the volume level, and turn it counterclockwise to decrease it.

#### ⑫ SURROUND MODE selector

This selector is used to select one of the two surround modes NATURAL SUR., and SIMULATED SUR. When this is set to the REC OUT MONI. position, the sound from the source selected by the REC OUT selector can be monitored.

### 13 REC OUT selector

This selector is used to select the source to be recorded on DECK B, and the source to be output to the VDP REC OUT jacks. To listen to the sound from the PHONO or VDP, set this selector to SOURCE and press the PHONO or VDP input selector. With this method, the sound from the selected source can be monitored with the rear speakers if the SURROUND MODE selector is set to REC OUT MONI. With this condition, if another source is selected with the input selector, the two different sources can be monitored at the same time, from both the front and rear speakers. (Dual-source monitor)

However, in direct recording mode, the source sound selected by the DIRECT RECORDING button will be monitored, regardless of the setting of the REC OUT selector.

- \* The sound from the turntable (PHONO) and the video disc (VDP) cannot be monitored at the same time using the dual-source monitor function.
- \* With the Auto Function operation engaged, when the input selector is changed while playing a record (PHONO), cassette tape (TAPE) or compact disc (CD), the playing source will be stopped. When activating the dual-source monitor, manually begin play of the source to be monitored with the rear speakers.

### 14 MIC jack

Plug a microphone into this jack to mix the sound from the source and the sound picked up by the microphone. Adjust the mixing level with the MIC MIXING control.

### 15 MIC MIXING control

This control is used to adjust the balance of the levels between the sound from the microphone and the source sound. Turn this control clockwise (toward MIC) to increase the level of the sound picked up by the microphone while decreasing the level of the source sound. Turn it counterclockwise (toward SOURCE) to increase the level of the source sound while decreasing the level of the microphone sound.

## CASSETTE DECK SECTION (See Fig. 7.)

### 16 Cassette holder

Press the EJECT section of the cassette holder to open the cassette holder. Insert a cassette tape with the tape exposed side down, then close the cassette holder.

### 17 DIRECTION indicators

These indicate the tape running direction.

### 18 REC indicator

This indicator lights when recording is engaged. In manual recording, this indicator lights when the REC/PAUSE button is pressed.

### 19 TIMER switch

**OFF:** Set to this position for normal recording and playback.

**REC:** In this position, unattended recording is possible, using a commercially available audio timer.

**PLAY:** In this position, timer playback is possible, using a commercially available audio timer.

### 20 TAPE COUNTER and RESET button

The TAPE COUNTER indicates the amount of tape running through DECK B. Pressing the RESET button will reset the TAPE COUNTER to "000".

### 21 REVERSE MODE selector

The incorporated auto reverse function allows the tape running direction to be reversed automatically. Three operation modes are available for the auto reverse function. Select the desired auto reverse mode with the REVERSE MODE selector.

Mode	Status	Playback	Recording (DECK B)	Fast-wind
		When playback of one side of a tape is finished, the deck stops at the end of a tape.	When recording onto one side of a tape is finished, the deck stops at the end of a tape.	Deck stops at the end of a tape.
		After the forward side (▶) of a tape is played back, the reverse side (◀) is played back. The tape stops at the tape end.		After termination of fast-forwarding (▶▶) the forward side of a tape, the reverse side (◀) is played back. The tape stops at the tape end.
		Both sides of a tape are repeatedly played back (up to 8 plays).	After the forward side (▶) of a tape is recorded, the reverse side (◀) is recorded. The tape stops at the tape end.	After termination of fast-forwarding (▶▶) the forward side of a tape, the reverse side (◀) is played back. After termination of fast-forwarding (◀◀) the reverse side of a tape, the forward side (▶) is played back.

In the mode, when the playback or recording starts on reverse side (◀), playback or recording does not change to forward side (▶) of a tape and after termination of fast-forwarding (◀◀) the reverse side of a tape, the tape stops at the end of a tape.

#### Note:

In this unit, the auto reverse operation functions by detecting the difference between the magnetic particle section and the leader tape section of a tape. Because of this, the auto reverse operation may malfunction. Be careful of the following items:

- When foreign objects are applied to the tape.
- When the tape is wrinkled or damaged.

- When the leader tape section is colored.
- When the inside of the cassette holder is exposed to direct sunlight or high-intensity lights, such as a spot light.
- When the leader tape detection sensor gets dirty.
- If the tape running direction is reversed in the middle of a tape due to a damage tape, set the REVERSE MODE selector to the position. In this setting, the tape will not stop halfway. In this case, recording or playback will stop at the tape end.

### 22 DOLBY NR switch

**OFF:** Set to this position when recording without the Dolby NR system or when playing a tape recorded without the Dolby NR system.

**B TYPE:** Set to this position when recording with the Dolby B NR system or when playing a tape recorded with Dolby B NR.

**C TYPE:** Set to this position when recording with the Dolby C NR system or when playing a tape recorded with Dolby C NR.

### 23 Display window

#### ① DECK A indicator

This indicator lights when a tape is loaded in DECK A.

#### ② RELAY indicator

This indicator lights when tapes are loaded in both deck A and deck B.

#### ③ DECK B indicator

This indicator lights when a tape is loaded in DECK B.

#### ④ DUBBING indicators

The NORM indicator lights when in normal speed dubbing mode, and the HIGH indicator lights in high-speed dubbing mode.

#### ⑤ DIRECT REC indicators

These indicators show the source to be recorded with the DIRECT RECORDING button.

#### ⑥ REPLAY indicator

This indicator lights when the CD REPLAY button is pressed.

#### 24 Main operation buttons

**SEARCH (◀◀, ▶▶):** During playback, the beginning of the next tune can be detected quickly by simply pressing a button. During playback in the forward (▶) direction, press the ▶▶ button to advance to the next tune, and press the ◀◀ button to return to the beginning of the current tune or previous tune. During playback in the reverse (◀) direction, the operation is reversed. In stop mode, these buttons are used to fast-wind or rewind the tape.

**Play (◀, ▶):** When either of these buttons is pressed, tape playback starts. When recording on DECK B manually, press the REC/PAUSE button then press this button to start recording.

**STOP (■):** When this button is pressed in any operation mode, the deck enters stop mode.

#### 25 REC MUTE button

When this button is pressed during recording, the deck automatically enters record-pause mode after recording a 4-second blank.

To record a blank of more than 4 seconds:

Keep pressing the REC MUTE button as long as required. When the button is released, the deck automatically enters record-pause mode after recording a 4-second blank.

To restart recording during an auto rec mute operation:

While the auto rec mute operation is engaged, press the play button.

The auto rec mute operation is released and the deck enters record mode again.

\* The REC MUTE button does not function during a tape dubbing operation.

#### 26 REC/PAUSE (●/■) button

When this button is pressed, the deck enters record-standby mode.

In this condition, pressing the play button starts manual recording.

To temporarily stop recording, press this button again. To restart recording, press this button once more.

#### 27 DIRECT RECORDING buttons

When any of the source buttons required for direct recording is pressed (CD, PHONO or TUNER) recording starts automatically. The DIRECT REC indicator corresponding to the button pressed will light.

#### 28 DUBBING buttons

When the NORMAL button is pressed, normal speed dubbing operation will start. When the HIGH button is pressed, high-speed (double-speed) dubbing will start.

#### 29 CD REPLAY button

With this button pressed on and the recording from a compact disc is interrupted in the middle of a tune due to a quick-reverse operation, recording will start again from the beginning of that tune after the tape is reversed.

### REMOTE CONTROL TRANSMITTER (See Fig. 3.)

#### 1 POWER key

Press this key to switch the power of the cassette amplifier ON and OFF.

#### 2 CD control keys

**CD:** When this key is pressed, the CD player starts to play and the input selector of the amplifier is automatically changed to CD.

\* The other keys function in the same way as those on the CD player.

#### 3 Tuner control keys

**TUNER:** When this key is pressed, the tuner receives a broadcast and the input selector of the amplifier is automatically changed to TUNER.

**UP, DOWN:** These keys are used to recall the broadcast stations stored in the preset keys of the tuner.

**P1-P8/P9-P16:** These keys function in the same way as the one on the Tuner.

#### 4 Cassette deck control keys

**TAPE:** When this key is pressed, the cassette deck starts tape playback, and the input selector of the amplifier is automatically changed to TAPE.

**DIR A:** Each time this key is pressed, the tape running direction of the tape loaded in DECK A is reversed.

**DIR B:** Each time this key is pressed, the tape running direction of the tape loaded in DECK B is reversed.

**A/B:** Each time this key is pressed, the controllable deck is alternated between DECK A and DECK B.

\* The other control keys function in the same way as those on the cassette deck.

## USING THE REMOTE CONTROL TRANSMITTER

### ⑤ Graphic equalizer control keys

**EQ ON/FLAT:** This key functions in the same way as the ON/FLAT button on the graphic equalizer.

**EQ UP, DOWN:** These keys are used to recall the equalizer curves stored in the EQ PRESET buttons 1 through 8 on the graphic equalizer.

### ⑥ Turntable control keys

**PHONO:** When this key is pressed, the turntable starts to play a record and the input selector of the amplifier is automatically changed to PHONO.

**PLAY/CUT:** This key functions in the same way as the PLAY/CUT button on the turntable.

### ⑦ VCR key

When this key is pressed, the input selector of the amplifier is changed to VCR.

### ⑧ VDP key

When this key is pressed, the input selector of the amplifier is changed to VDP.

### ⑨ VOLUME UP, DOWN keys

These keys function in the same way as the VOLUME control on the amplifier. Press the UP key to raise the volume level and press the DOWN key to lower it.

The remote control transmitter supplied with your cassette amplifier is designed to control all the most commonly used features of the cassette amplifier. If the CD player, tuner, turntable and equalizer connected to your amplifier are YAMAHA system components designed for system remote control compatibility (P-M555, T-M555L or T-M555, CD-M555 and EQ-M555), then this remote control transmitter will also control various functions of each component. Please consult your YAMAHA dealer for information on which components are compatible with the remote control transmitter. Note that this remote control will directly operate CD-M555 and EQ-M555.

### ■ REMOTE CONTROL OPERATION RANGE (See Fig. 9.)

### ■ BATTERY INSTALLATION (See Fig. 10.)

- ① Slide out the battery compartment lid in the direction of the arrow.
- ② Install the batteries (size "AA", R06) with correct polarities.
- ③ Attach the battery compartment lid until it clicks.

### ■ BATTERY REPLACEMENT

When the remote control operating distance becomes short, the batteries are weak. Replace the old batteries with new ones.

#### ● Battery cautions

Incorrect use of a battery may cause leakage or an explosion. Be careful of the following items:

#### ● When replacing:

- Replace only with "AA" (R06) batteries.
- Place the batteries in correct (+) and (-) polarities as indicated in the battery compartment.
- Do not use an old battery with a new one.
- Do not use different kinds of batteries (alkaline, heavyduty, manganese, Ni-Cad, etc.) at the same time.

#### ● Care of the remote control transmitter:

- When the remote control transmitter will not be used for an extended period of time, remove the batteries.
- Replace weak batteries early.

#### ● To prevent accidents:

- Never disassemble, heat or throw a battery into a fire. Dispose of batteries in specified places.
- Never connect (short) the (+) and (-) terminals directly with a metal piece, wire, etc.
- There are two kinds of batteries on the market; rechargeable and nonrechargeable. Carefully read all caution labels on the batteries.

#### ● In case of leakage:

Wipe off the electrolyte in the battery compartment completely before installing new batteries.

### ■ TO PLAY PROGRAM SOURCE

1. Press the POWER switch.
2. Use the input selector to select the program source to be heard.
3. Play the program source.
  - \* With a video signal from both VCR and VDP, when the input selector is changed to "TAPE", "TUNER", "CD" or "PHONO", the MONITOR OUT jack outputs the video signal from the VCR with priority over that from the video disc player.
4. Adjust the tone and volume level. Refer to the "VOLUME/TONE ADJUSTMENT" section of this manual.
  - \* For details of the surround mode, refer to "SURROUND SOUND PLAY" section of this manual.

#### ● Auto function

By simply pressing the TAPE input selector, the cassette deck will start playing automatically.

When the system component P-M555 or CD-M555 is connected, the turntable or CD player will start playing by pressing the corresponding input selector.

When the tuner (T-M555L or T-M555) is connected, the last channel will be heard by pressing the TUNER input selector.

- \* When the input selector is changed using the auto function during play, the currently playing source will be automatically stopped.
- \* With the PHONO, CD, TUNER or TAPE input selector pressed, pressing any of these selector will start play of the corresponding source automatically. However, with the remote control transmitter, you must press the PLAY key of the corresponding source.



## ■ VOLUME/TONE ADJUSTMENT

### ● Volume Level Adjustment

Adjust the volume level of the rear speakers with the REAR LEVEL control of the amplifier and the overall volume (both front and rear speakers) with the VOLUME control of the amplifier.

1. First turn the MIC MIXING control fully counterclockwise (toward SOURCE).
2. Adjust the volume with the VOLUME control. Turn the VOLUME control clockwise to increase or counterclockwise to decrease the level.  
The VOLUME indicator usually lights in green, however, it will light in red when the volume is controlled using the remote control transmitter.
3. When the rear speakers are used, adjust the volume of the rear speakers using the REAR LEVEL control. Turn it clockwise to increase or counterclockwise to decrease the level. When the rear speakers are not used, set the REAR LEVEL control to its "0" position.

### ● Tone Control Adjustment

The tone of the front speakers can be controlled as desired using the BASS and TREBLE controls and the BASS EXTENSION switch of the amplifier.

**BASS:** Used to control the low frequency response. Set to the DEFEAT position for flat response. Turn this control clockwise to boost the low frequency response or turn it counterclockwise to attenuate it.

**TREBLE:** Used to control the high frequency response. Set to the DEFEAT position for flat response. Turn this control clockwise to boost the high frequency response or turn it counterclockwise to attenuate it.

**BASS EXTENSION:** Press this switch to emphasize the super low frequencies (especially for frequencies around 80 Hz).

\* Tone control of the rear-channel sound is not possible.

### ● Balance Control

Volume balance between the left and right channels of the front speakers can be controlled with the BALANCE control of the amplifier. Turning the BALANCE control clockwise (toward R) will lower the left-channel sound, and turning it counterclockwise (toward L) will lower the right-channel sound. Balancing between the left and right channels of the rear speakers is not possible.

## ■ DUAL-SOURCE MONITOR

When a pair of rear speakers are added to this unit, two different sources can be monitored from the front and rear speakers simultaneously. Furthermore, since both front and rear PHONES jacks are provided with this unit, if two sets of stereo headphones are used, two different sources can be monitored with the headphones with the speakers' sound turned OFF (all speaker sound will be cut off).

### Example: To listen to an FM broadcast while playing a CD

1. Play the CD player and adjust the volume and tone as desired.
2. Set the REC OUT selector of the amplifier to "TUNER".
3. Set the SURROUND MODE selector to "REC MONI."
4. Press the PLAY button of the CD player to start playing.
5. Adjust the volume of the rear speaker with the REAR LEVEL control.

With this operation, the FM broadcast will be heard from the rear speakers, and the CD sound will be heard from the front speakers.

### ● To monitor with headphones

When optionally available headphones are connected to the PHONES jacks on the amplifier, the sound can be monitored with the headphones while the sound from the speakers is automatically cut. The PHONES jack outputs the front-channel sound from the source selected by the input selector, and the REAR PHONES jack outputs the rear-channel sound. If the SURROUND MODE selector is set to the REC MONI. position, the REAR PHONES will output the sound from the source selected by the REC OUT selector. (In this condition, when the REC OUT selector is set to SOURCE, the REAR PHONES jack will output the same sound as that from the PHONES jack.)

## ■ SURROUND SOUND PLAY

In a normal 2-channel system, sound is heard only from the front speakers to enable stereophonic playback. However, in a concert hall or in a theater, sound is heard not only from the front, but also from the sides and rear after the sound is reflected from the ceiling, walls, floor, etc. This makes contribute to the spacious and full sound of the hall. In the Surround Sound system, this 3-dimensional sound field is obtained by using an additional pair of speakers. As this unit incorporates a Surround Sound circuit in its amplifier section, you can enjoy dynamic surround sound and a 3-dimensional sound field by just adding a pair of rear speakers.

There are two Surround Sound modes available with this unit. Select the desired one (or most suitable one) with the SURROUND MODE selector, by referring to the following table.

	Source	Position	Effect
	All sources	OFF	No surround processing is in effect. The rear speaker signals are not output.
Stereo Source	Movies, Music and Sports Programs	NATURAL SUR.	Set to this position in normal surround playback.
Mono Source	Movies, Music and Sports Programs	SIMULATED SUR.	In this position, stereophonic sound will be simulated from monophonic source and a surround sound effect will be obtained. Set to this position when listening to monaural sources such as some video programs, FM/AM broadcasts, etc.

\* When a mono source is played with the SURROUND MODE selector set to the NATURAL SUR. position, no sound will be heard from the rear speakers.

## ■ PREPARATION FOR TAPE PLAYBACK

Before starting tape playback, prepare the unit in the following order:

1. Set the TIMER switch of the cassette deck to OFF.
2. Press the POWER switch to turn the unit ON.
3. Set the DOLBY NR switch to the proper position according to the tape used.
4. Select auto reverse mode with the REVERSE MODE selector as desired.

## ■ TAPE PLAYBACK (Common to DECK A and DECK B)

1. Perform the tape playback preparation as previously explained.
2. Decide the tape running direction (forward or reverse).
3. Load the tape into DECK A or DECK B.
4. Press the TAPE input selector. The auto function engages and automatically starts tape playback.
  - \* When the input selector is already set to TAPE, press the TAPE input selector or press the cassette deck play (◀ or ▶) button to start playback. When the ▶ button is pressed, tape playback starts in the forward direction, and when the ▶ button is pressed, tape playback starts in the reverse direction.
5. Adjust the tone and volume level. Refer to the section "VOLUME/TONE ADJUSTMENT".
6. To stop tape playback, press the STOP key of the playing deck.
  - \* Tape sound from both DECK A and DECK B cannot be listened to at the same time. When one deck is playing and the PLAY button of the other deck is pressed to start playback, the currently playing deck will stop, and the sound is changed to that of the newly engaged deck.

## ■ CUEING OPERATION

During playback, the beginning of the next or currently playing tune, can be searched for with the touch of a button.

● **To play the currently playing tune from the beginning**

During playback in the forward direction, press the ◀◀ button.

During playback in the reverse direction, press the ▶▶ button.

The tape is rewound to the beginning of the current tune and play starts from that point. If this operation is performed at the beginning section of a tune (within 10 seconds from the start of the tune), the tape will be rewound to the beginning of the previous tune.

● **To listen to the next tune**

During playback in forward direction, press the ▶▶ button.

During playback in reverse direction, press the ◀◀ button.

The tape is fast-forwarded to the beginning of the next tune, and play starts from that point.

\* A cueing (searching) operation is performed by detecting the blank section (of about 4 seconds or more) between tunes. Therefore, if the blank section is too short or noise is left in the blank section, the deck may operate incorrectly.



■ **RELAY PLAYBACK**

With this function, the tapes loaded in DECK A and DECK B are played back alternately. This is very convenient for long-term listening.

1. Perform the tape playback preparation as before. For setting of the REVERSE MODE selector, refer to "Relationship between Reverse Mode and Relay Play".
2. Decide the tape running direction of DECK A and DECK B.
3. Load the tape which is to be played first in DECK A.
4. Load the tape which is to be played next in DECK B. At this time, the RELAY indicator will light.
5. Press the TAPE input selector. The auto function is engaged, the DECK A indicator lights, and the relay play operation starts from DECK A.
  - \* When the input selector is already set to TAPE, press the TAPE input selector, or press the cassette deck play (◀ or ▶) button to start playback. When the ▶ button is pressed, relay play operation starts in the forward direction, and when the ◀ button is pressed, tape playback starts in the reverse direction.

● **Relationship between Reverse Mode and Relay Play**

Relay play operates differently depending on the setting of the REVERSE MODE selector. Set the REVERSE MODE selector by referring to the following table:

Reverse Mode	Relay Play Operation
	When playback of one side is finished in DECK A, DECK B starts playback. * Only the tape side designated by the play (◀ or ▶) button will be played back. * If playback starts from DECK B, when DECK B finishes playing, the cassette deck enters stop mode and DECK A does not start playing.
	When both sides are played back in DECK A, DECK B starts playback. * In both DECK A and DECK B, playback starts from the side designated by the play button. However, if DECK B starts in the reverse direction, when DECK B finishes playback, the cassette deck enters stop mode and DECK A does not start playback.
	Both sides of the tapes in both DECK A and DECK B are played back repeatedly (up to 8 cycles). * When 90-minute tapes are loaded into both DECK A and DECK B, relay play allows continuous playback for 24 hours. * When relay play starts from DECK B, the tape in DECK A will be played back 7 times, and the tape in DECK B will be played back 8 times. * If playback starts in the reverse direction, when the first side playback is finished, it is counted as one cycle.

■ **PREPARATION FOR RECORDING (DECK B only)**

Before starting to record on a tape, perform these preparations in the following order:

1. Set the TIMER switch of the cassette deck to OFF.
2. Press the POWER switch to turn the unit ON.
3. Set the DOLBY NR switch as desired.
4. Select auto reverse mode with the REVERSE MODE selector.
5. Decide the tape running direction of DECK B.
6. Load a cassette tape in DECK B.
  - \* The recording level is automatically controlled with the builtin ALC (automatic level control) circuit. The VOLUME control does not affect the recording level when a recording is being made.

## ■ RECORDING (DIRECT RECORDING/MANUAL RECORDING)

With this unit, two recording methods are available; direct recording and manual recording.

Direct recording allows you to start play of source equipment (tuner, CD player or turntable) and recording on the cassette deck simultaneously with a touch of a button, while manual recording permits you to start play and recording separately as desired.

In direct recording mode, recording will be done regardless of the setting of the input selector or rec out selector. Furthermore, the KA-M555 provides tape editing functions, especially when recording from a CD player, for added convenience.

### Direct Recording

1. Perform the "PREPARATIONS FOR RECORDING".
2. Prepare to play the source (or tune to the broadcast) to be recorded.
3. Press any of the DIRECT RECORDING buttons (CD, PHONO or TUNER) to start recording.
4. To stop recording, press the STOP button of DECK B.

### Manual Recording

1. Perform the "PREPARATION FOR RECORDING".
2. Prepare to play the source (or tune to the broadcast) to be recorded.
3. Select the source to be recorded with the REC OUT selector.
4. Press the REC/PAUSE button of the cassette deck, then press the play button (◀ or ▶) to start recording.
5. To stop recording, press the STOP button of DECK B.

## RECORDING FROM A FM/AM BROADCAST

### ● Direct Recording

1. Perform the "PREPARATION FOR RECORDING".
2. Tune to the broadcast station of the program to be recorded.
3. Listen to the broadcast station, and when the desired program begins, press the DIRECT RECORDING TUNER button. Recording automatically starts on the cassette deck.
  - \* Since direct recording can be activated regardless of the setting of the input selector or REC OUT selector, you can listen to any other source while recording.
4. To stop recording, press the STOP button of DECK B.

### ● Manual Recording

1. Perform the "PREPARATION FOR RECORDING".
2. Tune to the broadcast station of the program to be recorded.
3. Set the REC OUT selector of the amplifier to SOURCE or TUNER.
4. Press the REC/PAUSE button of the cassette deck. The REC indicator lights and the deck enters record-standby mode.
5. Listen to the broadcast station, and when the required program begins, press the play button of DECK B to start recording.
6. To stop recording, press the STOP button of DECK B.

### Note on manual recording:

- With the REC OUT selector set to SOURCE, when the input selector of the amplifier is pressed to change the listening source while recording, the recording source will also be changed.

## RECORDING FROM THE CD PLAYER (BASIC OPERATION)

### ● Direct Recording

1. Perform the "PREPARATION FOR RECORDING".
2. Load the disc to be recorded into the CD player.
3. Press the DIRECT RECORDING CD button of the cassette deck.

The input selector of the amplifier is automatically changed to CD, the CD player starts to play and the cassette deck starts recording simultaneously.

  - \* Since direct recording can be activated regardless of the setting of the input selector or REC OUT selector, you can listen to any other source while recording.
4. To stop recording, press the STOP button of DECK B, and then press the PAUSE/STOP button of the CD player twice.

### ● Manual Recording

1. Perform the "PREPARATION FOR RECORDING".
2. Load the disc to be recorded into the CD player, and set the play-pause mode at the beginning of the tune to be recorded.
3. Set the REC OUT selector of the amplifier to SOURCE or CD.
4. Press the REC/PAUSE button of the cassette deck. The REC indicator lights and the deck enters record-standby mode.
5. Press the play button of the CD player and the play button of the cassette deck simultaneously to start CD play and recording at the same time.
6. To stop recording, press the STOP button of DECK B, and then press the PAUSE/STOP button of the CD player twice.

**Note on manual recording:**

- With the REC OUT selector set to SOURCE, when the input selector of the amplifier is pressed to change the listening source while recording, the recording source will also be changed.



**EDITING FROM A COMPACT DISC (3-WAY CD DUBBING)**

• **To record only the desired tunes**

1. Perform the "PREPARATION FOR RECORDING".
2. Load the disc to be recorded into the CD player.
3. Program the tunes desired for recording from the CD player.
4. Press the DIRECT RECORDING CD button of the cassette deck.  
The input selector of the amplifier is automatically changed to CD, the CD player starts to play, and the cassette deck starts recording simultaneously.
5. To stop recording, press the STOP button of DECK B, and the press the PAUSE/STOP button of the CD player twice.





• **CD Replay Recording**

If recording is interrupted by a reverse operation in the middle of a tune, after the tape is reversed, the CD player returns to the beginning of the interrupted tune and then tape deck enters record mode again.

1. Perform the "PREPARATION FOR RECORDING". At this time, set the REVERSE MODE selector to the  or  position.
2. Load the disc to be recorded into the CD player.
3. Press the DIRECT RECORDING CD button of the cassette deck to activate direct recording.
4. Press the CD REPLAY button so that the CD REPLAY indicator lights.  
The CD replay function is now engaged. To release the CD replay function, press the CD REPLAY button again so that the CD REPLAY indicator goes off.
5. To stop recording, press the STOP button of DECK B, and the press the PAUSE/STOP button of the CD player twice.

• **Tape Program Recording**

By inputting the total recording time of a time into the CD player, a built-in microcomputer calculates which randomly arranged selections of the loaded disc will evenly record onto both sides of the tape.

1. Perform the "PREPARATION FOR RECORDING". At this time, set the REVERSE MODE selector to the  or  position.
2. Load the disc to be recorded into the CD player.
3. Press the TAPE PROG button of the CD player to activate tape program mode. At this time, the  indicator will light on the display of the CD player.  
"" shows that the CD player is in tape program mode.
4. Input the recording time for both sides of the tape with the numeric buttons.  
Example: To set a C-46 (46-minute) tape, input [+10], [+10], [+10], [+10] and [6].
5. Press the PROGRAM button of the CD player. The tunes to be recorded on side A of the tape are automatically, but randomly, programmed.
  - \* When the tunes for side A have been programmed, the PROGRAM indicator will light.  
Then, the number of programmed tunes and the total playing (recording) time of them are displayed.  
This time includes blanks of about 4 seconds between tunes.
6. Press the PROGRAM button again. The remaining tunes to be recorded on side B of the tape are automatically, and randomly, programmed. Then, the number of programmed tunes and the total playing (recording) time of them are displayed. This time includes blanks of about 4 seconds between tunes.
7. Press the DIRECT RECORDING CD button of the cassette deck to start recording.
8. Press the CD REPLAY button so that the CD REPLAY indicator lights.
  - \* To stop recording on its way, press the STOP button of DECK B, and press the PAUSE/STOP button of the CD player twice.
  - \* When all tunes to be recorded on side A of the tape are finished, the CD player enters pause mode until the tape is reversed for side B.
  - \* After all programmed tunes are recorded on both sides A and B, the CD player enters stop mode, but the deck continues to record, with no signal, to the end of the tape.

**Notes:**

- In operation 8, if the CD REPLAY button is not pressed, the tape continues running after it is reversed, but the CD player is left in pause mode.
- Up to 99 minutes can be set for the recording time for both sides of the tape.
- When a compact disc which contains more than 23 tunes is used, only the first 23 tunes will be used for random program recording.
- When no tunes can be recorded on side A of the tape, the display will show "Err". In this case, set the recording time for both sides of the tape again.
- When the tape is reversed while recording on side A in CD tape program mode, the CD player continues playing until the programmed tunes for side A are finished, then enters pause mode. Be sure to set the recording time for CD tape program mode according to the length of the tape.

**RECORDING FROM TURNTABLE****● Direct Recording**

1. Perform the "PREPARATION FOR RECORDING".
2. Place a phonograph record on the P-M555 turntable, and set the turntable to play standby mode.
3. Press the DIRECT RECORDING PHONO button of the cassette deck. The turntable starts to play, and several seconds later the cassette deck starts recording. At this time, the input selector of the amplifier is automatically changed to PHONO.
  - \* Since direct recording can be activated regardless of the setting of the input selector or REC OUT selector, you can listen to any other source while recording.
  - \* When the turntable finishes playing a record during direct recording, the deck also stops recording automatically.
4. To stop recording, press the STOP button of DECK B, and the press the play/cut button of the turntable.

**Note:**

The play/cut button of the turntable and the PHONO input selector of the amplifier do not function until the stylus is lowered to the record surface.

**● Manual Recording**

1. Perform the "PREPARATION FOR RECORDING".
2. Place a phonograph record on the turntable.
  - When the P-M555 is used as the turntable, set the CUE switch of the turntable to the UP position.
3. Set the REC OUT selector of the amplifier to the SOURCE position.
4. Press the PHONO input selector of the amplifier.
  - When the P-M555 is used, the platter starts rotating and the tonearm moves to the beginning of the record surface.
5. Press the REC/PAUSE button of the cassette deck. The REC indicator lights and the deck enters record standby mode.
6. Play the record manually, and press the play button of the cassette deck to start recording once the tonearm is lowered to the record surface.
7. To stop recording, press the STOP button of DECK B, and the press the play/cut button of the turntable.

**RECORDING FROM OTHER COMPONENTS**

When recording from other components (other than this system), perform a manual recording operation.

**● RECORDING FROM A VIDEO DISC**

1. Perform the "PREPARATION FOR RECORDING".
2. Load a video disc into the video disc player.
3. Press the VDP input selector of the amplifier.
4. Press the REC/PAUSE button of the cassette deck. The REC indicator lights and the deck enters record standby mode.
5. Set the REC OUT selector of the amplifier to the SOURCE position.
6. When the video disc starts to play, press the play button of the cassette deck to start recording.
7. To stop recording, press the STOP button of DECK B, and the operate the video disc player to stop playing.

● **RECORDING FROM A VIDEO TAPE**

1. Perform the "PREPARATION FOR RECORDING".
2. Load a tape into the VCR. (For details, refer to the instruction manual of each component.)
3. Press the VCR input selector of the amplifier.
4. Press the REC/PAUSE button of the cassette deck. The REC indicator lights and the deck enters record standby mode.
5. Set the REC OUT selector of the amplifier to the VCR or SOURCE position.
6. When the VCR deck starts playback, press the play button of the cassette deck to start recording.
7. To stop recording, press the STOP button of DECK B, and the operate the VCR to stop playback.

**RECORDING ON THE EXTERNAL COMPONENTS**

When an optional VCR is connected to the VCR jacks on the rear panel of the cassette deck amplifier, the sound played on this unit can be recorded on the VCR.

1. Referring to the instruction manual of the VCR, set the VCR to record-pause mode.
2. Set the REC OUT selector of the amplifier to the source to be recorded. However, when recording from the turntable, set the REC OUT selector to SOURCE and press the PHONO input selector of the amplifier. When recording from a video disc player, set the REC OUT selector to SOURCE and press the VDP input selector of the amplifier.
3. When the source equipment starts playback, start recording on the VCR.
4. After recording is over, operate the source equipment to stop playback.

**AUTO REC MUTE**

This function allows you to cut out unnecessary commercials or narrations when recording from an FM broadcast, etc., or to leave an appropriate blank section of 4 seconds between tunes with a touch of a button.

● **To leave a blank of 4 seconds:**

Press the REC MUTE button of the cassette deck. The deck runs for 4 seconds while recording no signal, then the deck automatically enters record-pause mode.

● **To leave a blank of more than 4 seconds:**

Press the REC MUTE button as long as required. After the button is released, the deck runs for 4 seconds while recording no signal, then automatically enters the record-pause mode.

● **To start recording during an Auto Rec Mute operation:**

Press the play button of the cassette deck. The Auto Rec Mute operation will be released and the deck will enter record mode.

\* The REC MUTE button does not function during a tape dubbing operation.

**REC RETURN FUNCTION**

When a tape is rewound during recording, the deck returns back to the position where the currently performed recording starts.

This function is convenient when recording is performed again from the beginning or when playing back the recorded section immediately after a recording is over.

When a recording is being made in the forward direction, press the ◀◀ button of the cassette deck, and when a recording is being made in the reverse direction, press the ▶▶ button of the cassette deck.

\* The Rec Return functions when recording continues for more than 4 seconds.

\* The Rec Return function is not available during a tape dubbing operation.

■ **TAPE DUBBING**

Tape dubbing (tape copying) from DECK A to DECK B can be activated with a touch of a button. And when high-speed dubbing is selected, the time required for tape copying is reduced to half the normal duplicating time.

1. Perform the "PREPARATION FOR RECORDING".
  2. Decide on the tapes for on both DECK A and DECK B.
  3. Load the playback (recorded) tape in DECK A, and load the blank tape in DECK B.
  4. Press the NORMAL or HIGH button to start a dubbing operation. To perform a normal dubbing operation, press the NORMAL button, and to perform a high speed dubbing operation, press the HIGH button.
- With a tape dubbing operation, the tape in DECK A is entirely copied onto the tape in DECK B, regardless of the DOLBY NR switch setting. (The sound heard from the speakers depends on the setting of the DOLBY NR switch.)

- During high-speed dubbing, sound having twice the normal frequencies is heard from the speakers.
- When a dubbing operation is completed, both DECK A and DECK B enter stop mode.
- When the tape in DECK A finishes playback before DECK B stops recording, DECK B enters stop mode after leaving a blank of about 4 seconds.
- When the tape in DECK B has finished before the tape in DECK A stops playback, both DECK A and DECK B enter stop mode.
- To stop a dubbing operation halfway, press the STOP button. At this time, if the STOP button of DECK A is pressed, DECK A enters stop mode, while DECK B enters stop mode after leaving a blank of about 4 seconds. If the STOP button of DECK B is pressed, DECK A and DECK B enter the stop mode immediately.

#### ■ MIC MIXING

By plugging a microphone (optional) into this unit, the sound picked up from the microphone can be mixed with the source sound, and the resulting sound can be heard from the speakers. This is called Mic Mixing.

1. Turn the VOLUME control fully counterclockwise.
2. Plug a microphone into the MIC jack of the amplifier. When the microphone has an ON/OFF switch, set it to ON.
3. Play the source to be mixed, and adjust the volume level with the VOLUME control.
4. Adjust the volume balance between the sound picked up from the microphone and the source sound with the MIC MIXING control. Turn the MIC MIXING control clockwise (toward MIC) to increase the level of the microphone sound while decreasing the source sound. Turn it counterclockwise (toward SOURCE) to decrease the microphone sound while increasing the source sound.

#### ■ MIC MIXING RECORDING

The sound resulting from mic mixing can be recorded on tape.

1. Load a tape into DECK B, and press the REC/PAUSE button of the cassette deck.
2. Plug in the microphone and play the source to be mixed with it. Then adjust the mixing balance with the MIC MIXING control.
3. Set the REC OUT selector to the SOURCE position.
  - \* If the REC OUT selector is set to a position other than "SOURCE", only the source selected by the REC OUT selector will be recorded onto tape instead of the mixed sound.
4. Press the play button of DECK B to start recording.

#### Notes:

- For Mic Mixing, use a monaural microphone having a standard phone plug (6.3 mm dia.), with an impedance of 400 ohms to 3 k-ohms and a sensitivity of around -74 dB.
- The sound picked up from the microphone is monaural (sounds of the left and right speakers are identical).
- If howling (a high pitched squeaking) occurs during Mic Mixing, lower the volume level or keep the microphone away from the speakers.
- With a microphone having higher sensitivity or omni-directional characteristics, howling may occur more frequently.
- Sound consisting of DECK A sound mixed with that from the microphone cannot be recorded onto DECK B.



## ■ TIMER RECORDING/PLAY BACK

When using the TIMER switch in combination with a commercial available audio timer, it is possible to make recordings and initiate playback at any time automatically by presetting the deck in advance.

### ● Timer Recording

1. Make sure that all power cord connections between the timer and amplifier are properly made. No change in any of the other connections is necessary.
  2. After tuning on the power to each component, select the station on your tuner which you want to record and turn down the volume on your amplifier. This will have no effect on the recording signal level. Remember to set the proper recording level.
  3. Set the timer to the desired times. It is advisable to set the timer to begin recording slightly before the actual recording time, and end slightly after the actual recording time, so that you leave some room for later editing.
  4. Set the TIMER switch to the REC position.
  5. The timer will send power to the amplifier, tuner and deck at the preset time, tuning all the components on and initiating the recording mode.
- \* After termination of the timer recording  
Prior to pressing the POWER switch ON, return the TIMERSwitch to the OFF position. With the TIMERSwitch kept at the REC position, when the power is tuned on, the recording content will be erased mistakenly.

### CAUTION:

If the tape cannot be ejected after timer recording, turn the TIMER switch OFF and KA-M555's POWER switch ON; the tape can then be ejected.

### ● Timer Playback

1. All connections are the same as for timer recording.
  2. Tune on the amplifier and adjust the volume and tone controls.
  3. Set the input selector of your amplifier to the tape mode.
  4. Set the timer to the time you wish to start and stop playback.
  5. Set the TIMER switch to the PLAY position.
  6. At the preset time, the timer will tune power on to the amplifier and tape deck and begin playback.  
When the cassette tapes are loaded in both decks, the unit enters the relay play mode and deck A starts playing. It will shut power OFF, at the preset time as well ending playback.
- \* After termination of the timer playback  
Return the TIMER switch to the OFF position. With the TIMER switch kept at the PLAY position, the playback starts needlessly when the power is tuned on.

## TROUBLESHOOTING

If your unit fails to operate normally, check the following points to determine whether the fault can be corrected by the simple measures suggested. If it cannot, or if the fault is not listed in the SYMPTOM column, disconnect the player's power cord and contact your dealer or service center for help.

	Symptom	Cause	Remedy
<b>Amplifier</b>	<b>No sound from either the left or right channel front speaker.</b>	● BALANCE control of the amplifier is turned toward L or R.	● Set the BALANCE control correctly.
		● Speaker cord is connected imperfectly.	● Connect the speaker cord correctly.
	<b>No sound from the front speakers.</b>	● MIC MIXING control of the amplifier is set to MIC.	● Turn the MIC MIXING control toward SOURCE.
		● VOLUME control of the amplifier is turned fully counter-clockwise.	● Turn the VOLUME control to an appropriate level.
		● Connection cords are connected imperfectly.	● Connect the connection cords correctly.
	<b>No sound from the rear speakers.</b>	● SURROUND MODE selector of the amplifier is set to REC MONI.	● Set the SURROUND MODE selector to the proper position.
		● REAR LEVEL control of the amplifier is turned fully counter-clockwise.	● Turn the REAR LEVEL control to an appropriate level.
● SURROUND MODE selector of the amplifier is set to NATURAL SUR.		● Set the SURROUND MODE selector to SIMULATED SUR.	
● Connection cords are connected imperfectly.		● Connect the connection cords correctly.	
<b>Bass is lacking, unnatural sound, unstable sound image.</b>	● Speaker cords are connected to the amplifier with incorrect polarity (+, -). (Phase incorrect)	● Connect the speaker cords with correct polarity (+, -).	
<b>Hum or howling in record play.</b>	● Turntable and speakers are closely installed (causing howling).	● Keep the turntable away from the speakers. Avoid installing the turntable at the corner of the listening room.	
<b>Cassette Deck</b>	<b>Tape does not run in recording/playback.</b>	● Tape is wrapped around the pinch roller due to slack.	● Remove the tape slack using a pencil before loading the tape.
	<b>Recording impossible.</b>	● Safety tab on the cassette is removed.	● Replace the cassette tape with a blank one, or block the safety tab hole using adhesive tape, etc.
		● Heads are dirty.	● Clean the heads.
	<b>Sound dropout, or interruptions.</b>	● Heads are dirty.	● Clean the heads.
		● Heads are magnetized.	● Demagnetize the heads using a head eraser (demagnetizer).
		● Old-fashioned tape is used.	● Replace with a quality one.
	<b>Poor quality in playback sound.</b>	● Noise reduction switch is improperly set.	● Set the DOLBY NR switch to the same position as in recording.
	<b>Left/right balance is unnatural.</b>	● Heads are dirty.	● Clean the heads.
<b>Noisy.</b>	● Heads are dirty.	● Clean the heads.	
	● Heads are magnetized.	● Demagnetize the heads using a head eraser (demagnetizer).	
	● Old-fashioned tape is used.	● Replace with a quality one.	

	Symptom	Cause	Remedy
Cassette Deck	Recording/playback stops in the middle.	● Tape was loosely wound or came out from the cassette.	● Using a pencil, etc., turn the reel hub to put tension on the tape.
		● Tape is folded or damaged.	● Replace with a new one.
		● 'Endless' tape is used for playback.	● Do not use an endless tape for playback.
	Search operation is impossible or incorrect.	● The blank between tunes is too short.	● Blank sections of more than 4 seconds are required between tunes for a search operation.
● There is a portion in which the recording level is very low in the middle of a tune.			
● Conversation or narration is included in the recording.			
Remote Control Unit	Remote control does not function.	● Batteries are exhausted.	● Replace the batteries with new ones.
		● Remote control unit is used in an area far from the main unit or out of controllable range.	● Operate in an area within 7m from the main unit, and with an angle of within 30 degrees to the remote sensor.
	TV receiver malfunctions when operating the remote control.	● Remote control is used near a remote controllable TV set.	● Keep the TV set away from this unit, or cover the remote sensor of the TV.



**YAMAHA**  
HAMAMATSU, JAPAN

YAMAHA

YAMAHA CORPORATION