



Yamaha Advanced DX/TX Plug-in Board
Yamaha Advanced DX/TX Plug-in Board
Carte plug-in DX/TX avancée Yamaha

PLG150-DX

Owner's Manual
Bedienungsanleitung
Mode d'emploi



English

Deutsch

Français

**MODULAR SYNTHESIS
PLUG-IN SYSTEM**



Precautions

- Do not expose the plug-in board to direct sunlight, excessive humidity, high temperatures, excessive dust or strong vibrations.
- Before handling the plug-in board, be sure to touch a metal surface to discharge any static electricity which may be in your body.
- When holding the plug-in board, do not touch the inside area of the circuit board or apply excessive pressure to the board, and be sure to protect the board from contact with water or other liquids.
- Before installing the plug-in board onto a tone generator/sound card, unplug the power connector of your computer.
- Before connecting the computer to other devices, turn off the power switches of all devices.
- Yamaha is not responsible for loss of data through computer malfunctions or operator actions.
- The plug-in board contains no user-serviceable parts, so never touch the inside area of the circuit board or tamper with the electronic circuitry in any way. Doing so may result in electrical shock or damage to the plug-in board.

YAMAHA CANNOT BE HELD RESPONSIBLE FOR DAMAGE CAUSED BY IMPROPER CARE AND USE OF THE PLUG-IN BOARD.

* The company names and product names in this Owner's Manual are the trademarks or registered trademarks of their respective companies.

* The screens as illustrated in this owner's manual are for instructional purposes only, and may appear somewhat different from the ones of your instrument.

FCC INFORMATION (U.S.A.)

1. IMPORTANT NOTICE: DO NOT MODIFY THIS UNIT!

This product, when installed as indicated in the instructions contained in this manual, meets FCC requirements. Modifications not expressly approved by Yamaha may void your authority, granted by the FCC, to use the product.

2. IMPORTANT: When connecting this product to accessories and/or another product use only high quality shielded cables. Cable/s supplied with this product **MUST** be used. Follow all installation instructions. Failure to follow instructions could void your FCC authorization to use this product in the USA.

3. NOTE: This product has been tested and found to comply with the requirements listed in FCC Regulations, Part 15 for Class "B" digital devices. Compliance with these requirements provides a reasonable level of assurance that your use of this product in a residential environment will not result in harmful interference with other electronic devices. This equipment generates/uses radio frequencies and, if not installed and used according to the instructions found in the users manual, may cause interference harmful to the operation of other electronic devices. Compliance with FCC regulations does not guarantee that interference will not occur in all installations. If this product is found to be the source of interference, which can be determined by turning the unit "OFF" and "ON", please try to eliminate the problem by using one of the following measures:

Relocate either this product or the device that is being affected by the interference.

Utilize power outlets that are on different branch (circuit breaker or fuse) circuits or install AC line filter/s.

In the case of radio or TV interference, relocate/reorient the antenna. If the antenna lead-in is 300 ohm ribbon lead, change the lead-in to co-axial type cable.

If these corrective measures do not produce satisfactory results, please contact the local retailer authorized to distribute this type of product. If you can not locate the appropriate, please contact Yamaha Corporation of America, Electronic Service Division, 6600 Orangethorpe Ave, Buena Park, CA 90620

* This applies only to products distributed by YAMAHA CORPORATION OF AMERICA.

CANADA

This Class B digital apparatus complies with Canadian ICES-003.

Cet appareil numérique de la classe B est conforme à la norme NMB-003 du Canada.

- This applies only to products distributed by Yamaha Canada Music Ltd.
- Ceci ne s'applique qu'aux produits distribués par Yamaha Canada Musique Ltée.

Congratulations and thank you for purchasing the Yamaha PLG150-DX Advanced DX/TX Plug-in Board!

The PLG150-DX features the same 6-operator FM tone generation system that powered the famous DX-series synthesizers. The PLG150-DX can be installed to and integrated with instruments of the Modular Synthesis Plug-in System (such as the CS6x, CS6R, S80, etc.) It can also be used seamlessly with the MU128 Tone Generator (as well as other MU-series instruments and the SW1000XG PCI Audio/MIDI Board). Once it's installed, the PLG150-DX puts the dynamic and flexible sound of FM synthesis right at your fingertips, with a total 912 DX-series voices.

The settings and parameters of the PLG150-DX can also be conveniently edited via MIDI with a Windows PC computer by using the DX Easy Editor and DX Simulator software modules (included in the XGworks Music Sequencer software).

To install your PLG150-DX correctly and to ensure full enjoyment of its sophisticated functions, be sure to read this manual very carefully. When finished, keep the manual in a secure and convenient place for future reference.

Table of Contents

Overview of the PLG150-DX	4	Selecting DX Voices (Modular Synthesis Plug-in System)	22
FM Tone Generation	6	Enabling and Selecting DX Voices	22
Operators.....	6	Editing the DX Native Part Parameters (Modular Synthesis Plug-in System)	23
Combinations of Two Operators.....	7	Selecting/Editing the DX System Parameters (Modular Synthesis Plug-in System)	24
Carrier and Modulator.....	8	Selecting DX Voices (XG Plug-in System)	25
Harmonics	9	Enabling and Selecting DX Voices	25
Algorithms.....	10	Editing the DX Native Part Parameters (XG Plug-in System)	27
Feedback.....	11	Selecting/Editing the DX System Parameters (XG Plug-in System)	28
Voice Editing Essentials	12	Parameters	29
Memory Buffer Structure	14	DX Native Part Parameters.....	29
Specifications	15	DX System Parameters	32
About the Included CD-ROM and Floppy Disk	16	Appendix	34
Installing the PLG150-DX	18	Chart of Algorithms	34
Included Items	18	Voice List	36
Required and Recommended Items	18	DX Parameter List (XG / Modular Synthesis Plug-in System)	46
Synthesizer/Tone Generator/ Sound Card Compatible with the Modular Synthesis or XG Plug-in Systems.....	18	MIDI Data Format	47
XGworks or XGworks lite Music Sequencing Software	19	When Your PLG150-DX Seems to Have a Problem	57
DX Easy Editor	19	MIDI Implementation Chart	60
DX Simulator	19		
Installing and Starting the Plug-in Editor Software (Windows 95/98)	20		
Installing the Software	20		
Starting the DX Easy Editor.....	20		
Starting the DX Simulator	21		

Overview of the PLG150-DX

■ FM Synthesis

The PLG150-DX employs the same FM tone generation system — with 6 operators and 32 algorithms — as made famous by the popular DX-series synthesizers.

■ 912 Preset Voices

Built right into the PLG150-DX is a huge total of 912 DX voices. From conventional instrument sounds such as electric piano and bass to wild and unusual sound effects, the PLG150-DX gives you the full range of voices that made the DX-series instruments famous.

■ 16-note Polyphony

The PLG150-DX features a maximum polyphony of 16 notes, the same as on the DX7 and DX7II. However, unlike with those instruments, you can install multiple PLG150-DX boards (up to a maximum of eight) for a total polyphony of 128 notes. For example, when three PLG150-DX boards are installed to a MU128 tone generator, the maximum polyphony becomes 48 voices.

■ Voice Data Transfer

Since the PLG150-DX is compatible with the DX-series instruments, voice data can be transferred between the plug-in board and the DX7 or DX7II. This allows you to use those instruments (or compatible editing software) to edit and create voices, which can then be transferred to the PLG150-DX. The PLG150-DX is also compatible with voice parameters for the DX1, DX7S, TF1 modules (such as for the TX816), TX7, and the TX802.



Some voices on the compatible devices mentioned above may sound slightly different when played on the PLG150-DX.

■ Built-in Filters and Equalizer

The PLG150-DX gives you additional sound-shaping power with built-in low pass and high pass filters, plus a two-band equalizer. You can use these together with other FM voice parameters to create your own original voices.

MODULAR SYNTHESIS PLUG-IN SYSTEM

About the Modular Synthesis Plug-in System

The Yamaha Modular Synthesis Plug-in System offers powerful expansion and upgrade capabilities for Modular Synthesis-Plug-in-compatible synthesizers, tone generators and sound cards. This enables you to easily and effectively take advantage of the latest and most sophisticated synthesizer and effects technology, allowing you to keep pace with the rapid and multi-faceted advances in modern music production.



About the XG Plug-in System

The Yamaha XG Plug-in System offers powerful expansion and upgrade capabilities for XG-Plug-in-compatible tone generators and sound cards. This enables you to easily and effectively take advantage of the latest and most sophisticated synthesizer and effects technology, allowing you to keep pace with the rapid and multi-faceted advances in modern music production.

FM Tone Generation

Before actually editing the PLG150-DX voices, let's get an idea of how the FM tone generator works.

Operators

In the PLG150-DX, there are six special devices called “operators” that generate sine waves. A sine wave is the fundamental wave of a note, with absolutely no overtones or harmonics added. These six operators are combined in various ways to make up the different voices produced by the PLG150-DX. The operators can be used to freely change two different aspects of the sound:

- (1) **The frequency (pitch) of the generated sine wave.**
- (2) **The amplitude (volume or output level) of the generated sine wave.**

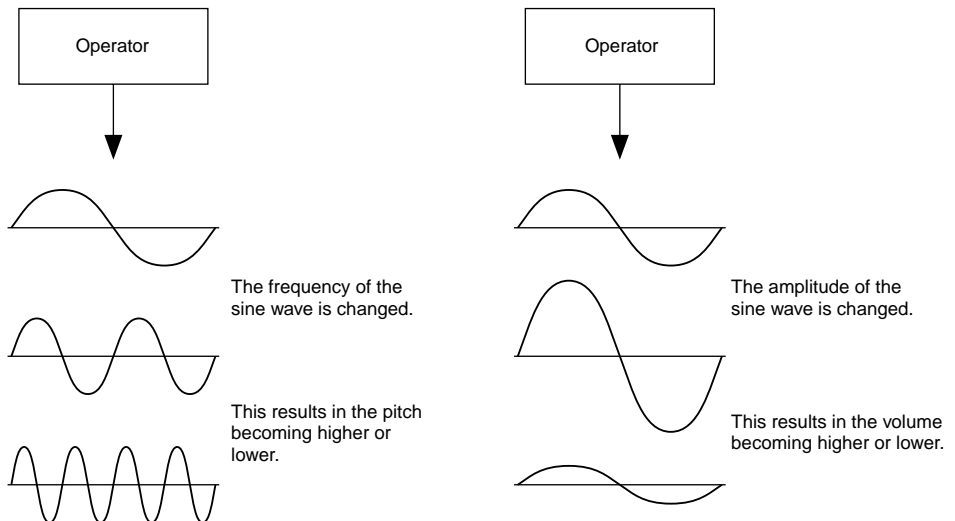

Combinations of Two Operators

Although the six operators can be combined in a wide variety of ways for many different sounds, here we'll look at the fundamental combinations of just two operators, to help you understand the basics of FM synthesis.

Two sine wave operators (labelled "A" and "B" here) can be combined in one of two ways: horizontally or vertically.

(1) Horizontal Combination

When the two operators are combined horizontally, the sounds of the two are simply mixed together. This combining of two or more different sounds is called additive synthesis.

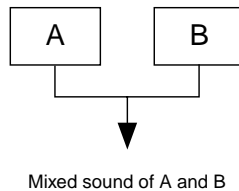

(2) Vertical Combination

When the two operators are combined vertically, the sound of the top operator (B) "modulates" that of the lower operator (A). In this situation, operator B produces no sound, but alters the sound of operator A, producing a sound of greater harmonic complexity. This "stacking" of operators is called Frequency Modulation (FM) synthesis.

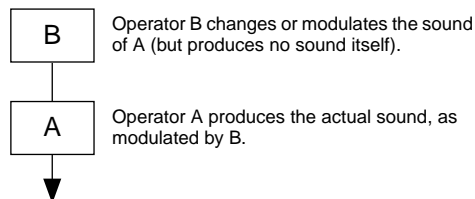

To sum it up, when two operators are combined horizontally, both operators generate the sound; when combined vertically, one operator changes the sound, the other produces it.

Carrier and Modulator

In FM tone generation, each of the six operators functions as either a carrier or a modulator. The operator doing the modulation is called the modulator; the one being modulated and delivering the actual sound is called the carrier. Referring back to “Vertical Combination” on the previous page, operator A is the carrier and operator B is the modulator.

Let’s take a look at some more complex configurations, in which three or more operators are used. Keep in mind that the modulator/carrier function is the same in all examples.

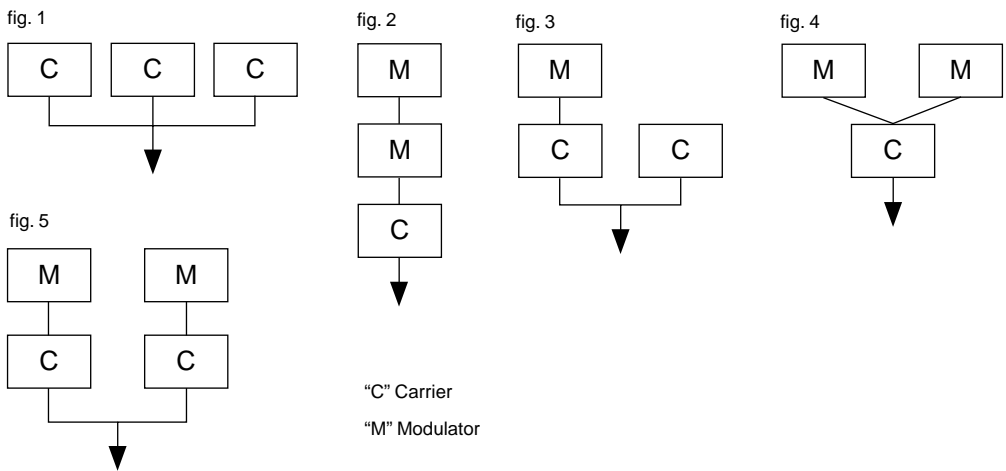

- In fig. 1, all operators are combined horizontally and there are no modulators, only carriers. Without modulation, all carriers output simple sine waves.
- In fig. 2, three operators are stacked vertically, and only the lowest is a carrier. The top operator modulates the middle one, which in turn modulates the carrier at the bottom. This results in a complex waveform, with many harmonics or overtones. (An explanation of harmonics follows on the next page.)
- In fig. 3, there are two carriers and one modulator. The sole carrier on the right produces a simple sine wave, while the modulator/carrier pair on the left produce a more complex waveform with added harmonics. The actual sound is a mix of the two carriers.
- In fig. 4, two modulators are used change the sound of a single carrier. Using two modulators produces an even more complex sound than is possible with one, with a greater amount of harmonics.
- In fig. 5, there are two modulator/carrier pairs, each generating a complex sound with many harmonics. As with the operators in fig. 3, the actual sound is a mix of the two carriers.

Harmonics

Most sounds are made up of multiple tones that are different than the pitch (frequency). Within these multiple tones, the one that determines the pitch of the entire sound is called the fundamental tone (fundamental frequency). All the tones besides the fundamental tone are called harmonics or overtones.

When all the harmonics that are related to a particular fundamental tone are arranged in order, it is called a harmonic series. Each tone in the harmonic series is given a name in order, with the fundamental tone being one, followed by the second harmonic, third harmonic and so on.

The frequency of each harmonic in the harmonic series is a natural number multiple of the frequency of the fundamental tone. Overtones that have frequencies that are not natural number multiples of the fundamental are called unharmonic overtones.

Generally, the more harmonics the tone has, the brighter the sound. On the other hand, if the amount of harmonics is reduced, the tone will sound darker. Furthermore, the voice will change a lot according to the type and volume of the harmonics. For example, if there are a lot of high pitched harmonics in the tone, it will have a brilliant, crisp sound. On the other hand, a tone with a large amount of lower harmonics will have a rather “fat,” warm sound.

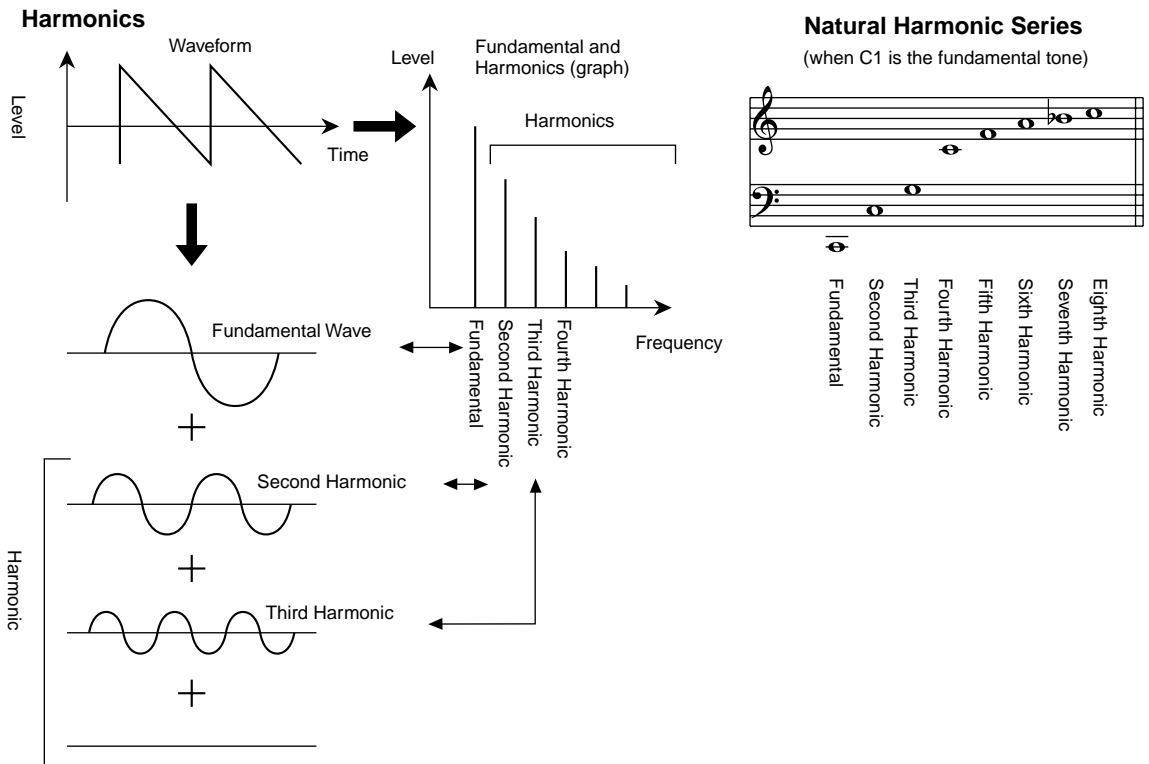

Algorithms

Although two operators can be combined in only two different ways, six operators can be configured in a wide variety of combinations. These combinations are called “algorithms.” Just as on the original DX7, the PLG150-DX features 32 different algorithms, giving you different levels of harmonic complexity for various applications.

Since the function of any given operator depends on the particular algorithm, you should check a voice’s algorithm carefully while editing the voice. For a chart showing all 32 algorithms, see page 34. Each operator in the algorithm is numbered to distinguish it from the others in editing.

Let’s take a look at algorithm 28 as an example. The various operators function as follows:

- Operator 1.....Carrier; is modulated by Operator 2, and outputs the resulting sound.
- Operator 2.....Modulator; modulates Operator 1.
- Operator 3.....Carrier; is modulated by Operator 4, and outputs the resulting sound.
- Operator 4.....Modulator; modulates Operator 3.
- Operator 5.....Modulator; modulates itself with a feedback loop, and modulates Operator 4.
- Operator 6.....Carrier; outputs a sine wave.

Algorithm 28

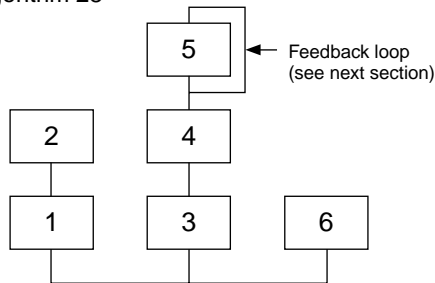

Feedback

Each algorithm has a special feedback loop, programmed to a fixed location in the algorithm. With feedback, a modulator's output is connected to its own input, so that it modulates itself. This can be used to increase the harmonic content of the sound, making it more rich and complex. When set to a high level, feedback can generate noise effects — making it useful for percussive voices, metallic sounds, and distortion effects.

Some algorithms feature a feedback loop that takes in two or three operators as a group. One such example is algorithm 4 shown below, in which the output of operator 4 is returned to the input of operator 6, thus modulating the entire stack. This provides even greater possibilities for tonal variation and richness.

Algorithm 4

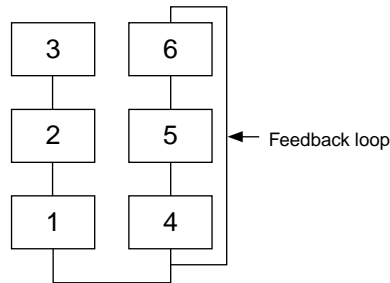

Voice Editing Essentials

There are four main elements that determine the character of a voice:

- (1) Each operator's output level.
- (2) Each operator's frequency.
- (3) The feedback level.
- (4) Each operator's envelope generator (EG).

(1) Operator Output Level

The output levels of the operators are the most important parameters in editing a voice. Among these, the output level of the modulator(s) has the greatest effect on the timbre or tonal quality of the voice. If a modulator's output level is set to "0" so that it does not modulate the carrier, the resulting output of the carrier will be a simple sine wave (below). Increasing the output of the modulator increases the degree of modulation and, hence, the amount of harmonics in the sound. Generally, the greater the modulator's output, the brighter the sound will be. Extremely high values result in a harsh, noisy sound.

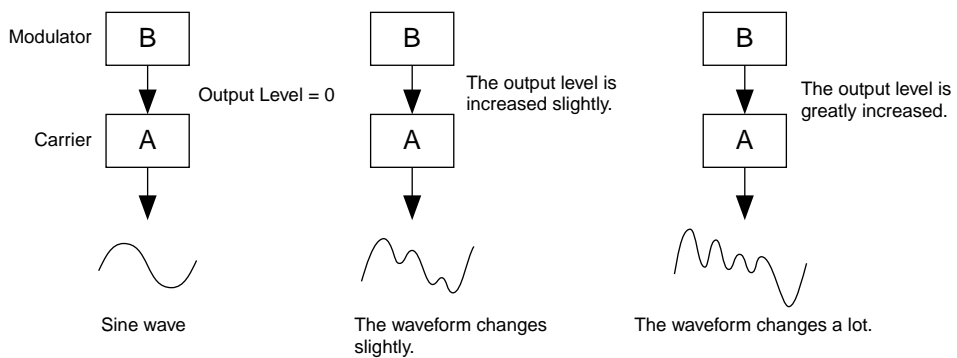

Since the carrier actually produces the sound, increasing the output level of a carrier increases the volume of the sound. If there are two or more carriers, changing the output level of individual carriers may also affect the timbre of the sound, since the volume balance of the different carriers is changed.

(2) Operator Output Frequency

The type of harmonics added to the carrier output by means of the modulator is determined by the ratio between the frequencies of the modulator and carrier. For example, when two operators are combined vertically, and "F COARSE" for both of them is set to 1.00, the frequency ratio will be 1:1 and the first, second, third and following whole number series harmonics will be generated in order. This type of harmonic configuration is called a sawtooth wave, and is used for making voices like brass, strings, or piano.

If the “F COARSE” for the modulation in this situation is changed to 2.00, the frequency ratio becomes 1:2, and the odd numbered harmonics, the first, third and fifth and following harmonics will be generated. This harmonic configuration is called a rectangular wave, and is used for creating woodwind voices for like clarinet and oboe.

Furthermore, if “F FINE” is set so that the frequency ratio is not a whole number, many non-integer overtones will be produced. The sound can be used for creating metallic sounds, the noise when strings are hit with something, or breath noise.

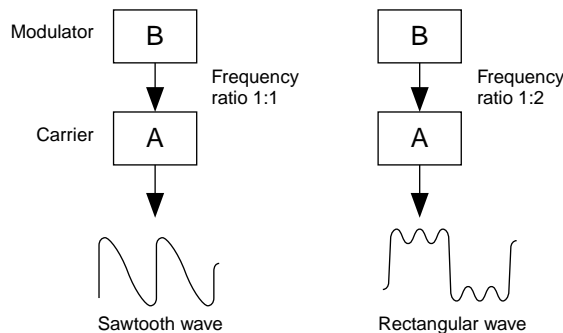

(3) Feedback Level

As we saw earlier, feedback is a function in which a modulator’s output is connected to its own input, so that it modulates itself. Increasing the feedback level increases the harmonic content of the sound, making it brighter and complex. Keep in mind that the total effect also depends on the output level of the feedback-applied operator; if that operator’s output level is set to “0,” feedback level will have no affect on the sound.

(4) EG (Envelope Generator)

The EG (Envelope Generator) parameters allow you to shape the sound of the voice. In other words, these determine how the level of the voice changes over time, from when a key on the keyboard is played until it is released and the sound dies out.

The EG parameters let you reproduce the sound of acoustic instruments, and their natural patterns of attack, sustain and decay. For example, the sound of a piano has a very sharp attack and a moderately long sustain: The sound gets loud the instant a key is played, and gradually fades away as the key is held. The tone or timbre of the sound also changes in time, with the sound starting out very bright and gradually growing warmer and softer (as the harmonics start to fade).

Since each operator has its own EG, the PLG150-DX gives you comprehensive and dynamic control over both the volume and timbre of the voice, letting you accurately reproduce these natural acoustic effects. The carrier EGs affect the volume of the sound over time, while the modulator EGs affect the timbre.

Memory Buffer Structure

The diagram below shows the memory buffer configuration of the PLG150-DX.

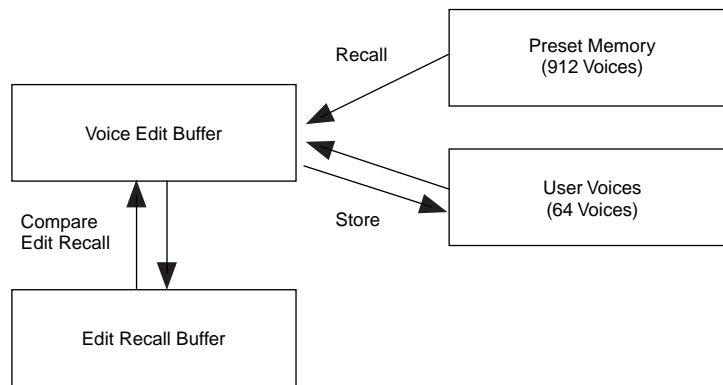

When editing the voices (using the DX Simulator), only the User voices can be fully edited; Preset voices can be edited only as far as the XG and DX Native Part parameters.



When Using the User voices:

- When a DX voice is selected from one of the User voices, the DX voice's settings for the following parameters take precedence over the corresponding settings.

XG Native Part Parameters

- Mono/Poly Mode
- Pitch Bend Control
- Portamento Switch
- Portamento Time

PLG150-DX Native Part Parameters

- Pitch Bend Step
- Portamento Step
- Portamento Mode

In other words, the settings of these XG Part parameters (on an MU128, etc.) are replaced by those of the selected DX voice. Naturally, once the voice is selected, the Part parameter values can then be changed from the panel of the XG-compatible "mother" device (MU128, etc.). The XG Native Part parameters can also be changed by appropriate parameter change messages.

- If an XG System On is received, or part assignment is changed, the User voices will be initialized, but the 64 voice VMEM and AMEM areas will not be initialized.

Specifications

- Tone Generator Type :** FM tone generator with six operators and 32 algorithms
- Maximum Simultaneous Polyphony :**
16 notes (latest note priority)
By using multiple boards in combination, polyphony can be expanded to a maximum of 128 notes (with 8 boards)
- Filters :** Part EQ (two band), low pass filter, high pass filter (effective only when the platform for the PLG150-DX has no filter functions)
- Interface :** Plug-in connector
- Number of Voices :** 912 preset voices, 64 user voices
- Bulk Information that Can Be Received from Other Devices :**
DX7 Voice Edit Buffer, Packed 32 Voice
DX7II Voice Edit Buffer, Packed 32 voice, a portion of the Additional Edit Buffer, a portion of the Packed 32 Additional (Pitch EG range, rs, velocity switch, Unison detune, AMS, Random pitch, Poly/Mono, Unison Sw, Pitch bend range, step, Portamento mode, step, time)
- Parameter Changes that Can Be Received from Other Devices :**
DX7 VCED, a portion of ACED (Pitch EG range, rs, velocity switch, Unison detune, AMS, Random pitch, Poly/Mono, Unison Sw, Pitch bend range, step, Portamento mode, step, time)
- Dimensions (W x H x D) :** 138.5 x 89.0 x 8.5mm
- Weight :** 63g
- Included Items :** Owner's Manual, CD-ROM × 1

* Specifications subject to change without notice.

About the Included CD-ROM and Floppy Disk

On the included CD-ROM, you'll find special editing software for the PLG150-DX. The included floppy disk contains demonstration songs as well as Voice/Performance data for the "mother" device.

To use the editing software and transfer the song/Voice/Performance data to your particular "mother" device, you should have a computer (running Windows 95/98) with a MIDI interface, with the MIDI OUT on the interface connected to the MIDI IN of the "mother" device. You should also have XGworks (v3.0 or higher) or XGworks lite installed to your computer; this is necessary to use the editing software (page 19). In order to use the editing software, insert the CD-ROM into the computer and start the installation.

For playing back the demonstration songs and transferring the Voice/Performance data, you can use any compatible sequence software (such as XGworks/XGworks lite) or hardware sequencer capable of sending bulk data.

The included CD-ROM contains the following software:

- **DX Easy Editor (page 19)**
- **DX Simulator (page 19)**

The included floppy disk contains the following software:

■ **Demonstration Songs**

"Many Colors of the DX7 system" (02Colors.MID)

By: Hirohiko Fukuda of Shofuku

For: Modular Synthesis Plug-in System devices (CS6x, etc.)

One of the strongest points of FM Synthesis is its ability to create complex overtones in real time. In this song, system exclusive messages are used, in addition to velocity, to directly control the output of the modulators. This creates an even greater variety of sound changes — allowing complex sound shaping that just isn't possible through wave sampling and conventional filter systems.

"The Soul Of DX" (12SoulDX.MID)

By: Minoru Mukaiya of Casiopea

For: XG Plug-in System devices (MU128, etc.)

This powerful song uses the crystal-clear sound of the DX7 with techno drums, and combines the XG and DX systems to produce an extraordinarily dynamic sound.

"le Kia Bara Hein" (12leKia.MID)

By: Noritaka Ubukata of Shofuku

For: XG Plug-in System devices (MU128, etc.)

The title of the song means "What kind of spell is this?" in the Hindi language. It features the voice that simulates a santur (hammer dulcimer) together with a sitar.

"DX VOICE" (12Voice.MID)

By: Noritaka Ubukata of Shofuku

For: XG Plug-in System devices (MU128, etc.)

Starting with an electric piano sound, this song features a variety of popular voices used with the original DX7. The changes in velocity produce subtle variations in the sound that cannot be accomplished with sampling. Another special feature is the FM choir (starting around measure 43). You may want to try mix this sound with an actual human voice or choir — for example, by using the data in track 1 to also play a connected sampler — you can get a much more dynamic and realistic choir sound.

"Vel&EffectWorks1" (12V_EfW1.MID)

"Vel&EffectWorks2" (12V_EfW2.MID)

"DX Short Demo" (12ShtDM.MID)

By: Yasuhiko Fukuda of Shofuku

For: XG Plug-in System devices (MU128, etc.)

These songs showcase the unique ability of FM Synthesis to use velocity to produce dramatic changes in the sound.

“80’s Pops” (12Pop80.MID)

By: Katsumi Nagae of Idecs Inc.
For: XG Plug-in System devices (MU128, etc.)

This song recalls the pop scene of the 80’s with synth pads and a variety of crisp and bright metallic sounds.

“D-Rock” (12DRock.MID)

By: Katsumi Nagae of Idecs Inc.
For: XG Plug-in System devices (MU128, etc.)

This song brings back the digital rock sound and features various digital noise and FM sound effects that are only possible with the DX.

“EP Ballade” (12Ep.MID)

By: Katsumi Nagae of Idecs Inc.
For: XG Plug-in System devices (MU128, etc.)

If it’s ballads you want-well, there is nothing like DX electric piano.

The voice in the electric piano part will also work with different electric pianos. Try playing the song with different piano voices.

“House” (12House.MID)

By: Katsumi Nagae of Idecs Inc.
For: XG Plug-in System devices (MU128, etc.)

The typical house music sound is simulated in this song, which experiments with reproducing sampling phrases using the DX Voice system. In addition, the second half of the song features the metallic sound that is a strong point of the DX.

“Jungle” (12Jungle.MID)

By: Katsumi Nagae of Idecs Inc.
For: XG Plug-in System devices (MU128, etc.)

This song adds a touch of Chinese feeling to the Jungle. The Oriental image is underscored by the “CHINA_S&” and “IMAGE9” plug-in SE voices.



If no sounds are played, or if you experience other problems with playback, see Appendix “When Your PLG150-DX Seems to Have a Problem.”

■ Plug-in Voice Data for the CS6x/CS6R/S80 (Modular Synthesis Plug-in System)

This is Plug-in voice data, featuring a total of 64 voices that were created using the PLG150-DX Preset voices. When the PLG150-DX is installed to PLG1, select the file “01PlgVc1.mid”; when the board is installed to PLG2, select the file “01PlgVc2.mid”.



For a complete list of these voices, refer to the Plug-in Voice List in the Owner’s Manual.

■ Performance Data for the MU128/MU100/MU100R (XG Plug-in System)

This is Performance data, featuring a total of 64 Performances that were created using the PLG150-DX Preset voices (“11Perf.MID”).



For a complete list of these Performances, refer to the Performance List in the Owner’s Manual.

Installing the PLG150-DX

For detailed instructions on installing the PLG150-DX, refer to the owner's manual of the Plug-in-compatible "mother" device (e.g., CS6x, MU128, etc.).

Included Items

The following items have been included in the package of your new PLG150-DX. Please make sure that you have them all before starting to setup and use the instrument. If an item is missing, contact the store or dealer from which you purchased the PLG150-DX.

- PLG150-DX board
- PLG150-DX Owner's Manual (this book)
- CD-ROM
- Floppy Disk

Required and Recommended Items

In addition to the included items listed above, you should also have the following:

Synthesizer/Tone Generator/Sound Card Compatible with the Modular Synthesis or XG Plug-in Systems

In order to use the PLG150-DX, you'll need a synthesizer, tone generator or sound card compatible with the Modular Synthesis Plug-in System or the XG Plug-in System. Compatible instruments include the CS6x, MU128, and the SW1000XG. The synthesizer/tone generator/sound card should also have an available slot or space for installing the PLG150-DX.

XGworks or XGworks lite Music Sequencing Software

When you use Yamaha's XGworks(lite) as your sequence software, you can take advantage of the two editing software programs explained below, the "DX Simulator" and the "DX Easy Editor." These programs make it really easy to edit the voices of your PLG150-DX board.

DX Easy Editor

The DX Easy Editor is a special plug-in software module for XGworks and XGworks lite. It provides convenient easy-to-use control over the most important PLG150-DX settings and parameters. It also provides exceptionally intuitive editing, with virtual sliders and buttons, as well as special graphs with click-and-drag operation.

Using the DX Easy Editor is just like using the Part editing controls on your tone generator — it indirectly and temporarily changes the DX voices without making changes to the original voice. The changed parameters can either be inserted into a song to automate sound changes, or can be saved as a DX Parameter file for future recall. Continuous real-time parameter changes can be recorded to a song as well. The DX Easy Editor software is contained on the included CD-ROM.

DX Simulator

As with DX Easy Editor above, the DX Simulator is special software for use with XGworks and XGworks lite. It allows you to directly edit all of the DX voice settings and parameters from your computer. It also provides exceptionally intuitive editing, with a virtual "front panel" display that lets you change the settings with buttons and sliders, just as you would on an actual DX7. It also features a special Edit List window, that lets you quickly and easily edit all parameters from one convenient chart.

More comprehensive than the DX Easy Editor above, the DX Simulator gives you convenient access to all of the PLG150-DX's parameters, controls and functions. The changed parameters can either be inserted into a song to automate sound changes, or can be saved as a DX Cartridge file for future recall. Continuous real-time parameter changes can be recorded to a song as well. It also lets you save your edits directly as a User voice for future recall. The DX Simulator software is contained on the included CD-ROM.

Installing and Starting the Plug-in Editor Software (Windows 95/98)

Installing the Software

Double-click the “Setup.exe” file on the CD-ROM to start the installation. Click “Next” or “Yes” and follow the subsequent instructions on the screen to complete the installation.

Starting the DX Easy Editor

- 1 Start XGworks (or XGworks lite).
- 2 Click the “Plug-in” menu and select “DX Easy Editor.”

Alternately, press Alt + P, then D, and ENTER. The “Select DX Part” dialog box appears.

- 3 Set the desired Part number and click “OK.”

The DX Easy Editor window appears.

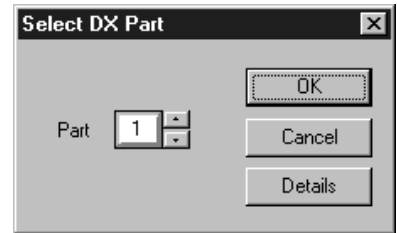

If the PLG150-DX has been properly installed and all computer/MIDI connections have been properly made, operating the DX Easy Editor should directly affect the PLG150-DX. For details on using the DX Easy Editor, refer to the on-line help file that is included with the software.



When using a Modular Synthesis Plug-in System “mother” device, the Part assignment depends on which mode is used — Voice or Performance — and also on whether the PLG150-DX board is installed/assigned to PLG1 or PLG2, as described below.

When using the Voice mode:

Depending on which slot the PLG150-DX board has been installed to, press PLG1 or PLG2, then set the Part to “1” (no matter what the PLG1 or PLG2 assignment is).

When using the Performance (Multi) mode:

If the PLG150-DX board is assigned to PLG1, set the Part to “16.”

If the PLG150-DX board is assigned to PLG2, set the Part to “15.”

Starting the DX Simulator

1 Start XGworks (or XGworks lite).

2 Click the “Plug-in” menu and select “DX Simulator.”

Alternately, press Alt + P, then D, and ENTER. The “Select DX Part” dialog box appears.

3 Set the desired Part number and click “OK.”

The DX Simulator window appears.

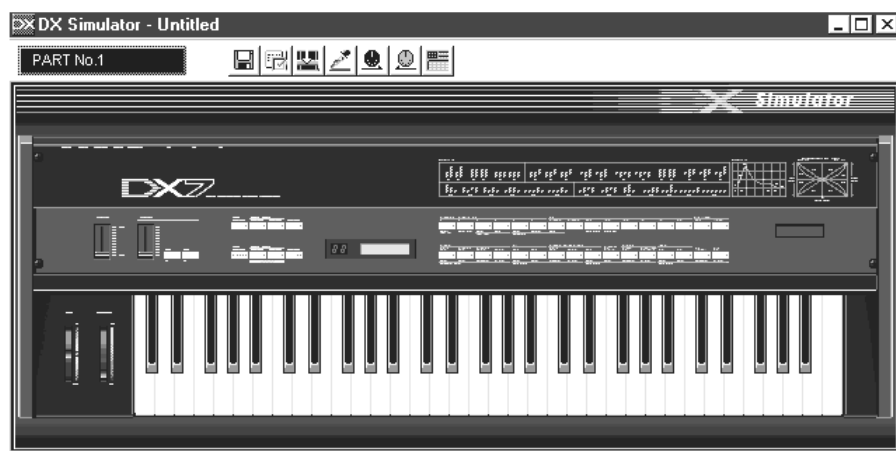
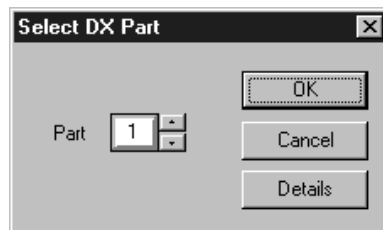

If the PLG150-DX has been properly installed and all computer/MIDI connections have been properly made, operating the DX Simulator should directly affect the PLG150-DX. For details on using the DX Simulator, refer to the on-line help file that is included with the software.



- To use the DX Simulator, your copy of XGworks must be version 1.05 or later. You can download the proper update of XGworks or XGworks lite from the Yamaha website (<http://www.yamaha.co.uk>).
- When using a Modular Synthesis Plug-in System “mother” device, the Part assignment depends on which mode is used — Voice or Performance — and also on whether the PLG150-DX board is installed/assigned to PLG1 or PLG2, as described below.

When using the Voice mode:

Depending on which slot the PLG150-DX board has been installed to, press PLG1 or PLG2, then set the Part to “1” (no matter what the PLG1 or PLG2 assignment is).

When using the Performance (Multi) mode:

If the PLG150-DX board is assigned to PLG1, set the Part to “16.”

If the PLG150-DX board is assigned to PLG2, set the Part to “15.”

Selecting DX Voices (Modular Synthesis Plug-in System)

When the PLG150-DX is installed to a CS6x Control Synthesizer, the DX voices can be selected in the same way as the internal voices of the synthesizer.

NOTE The example displays used in the following explanations are all taken from the CS6x.

Enabling and Selecting DX Voices

- 1 Press the VOICE button.
- 2 Press the appropriate PLG button (PLG1 or PLG2, depending on which slot the PLG150-DX board has been installed to), then press the appropriate BANK button and PROGRAM button to select the desired Plug-in voice.

```
VCE Play) PLG1:001(A01)[--:Plig-InVce]  
EQLow-G EQMid-G EQHi-G -----
```

NOTE To select a different bank, simultaneously hold down the appropriate PLG button and turn knob C (or press the DEC/INC buttons) to select the desired bank. The bank is expressed in two numbers: MSB and LSB.

```
VCE Play) P1-B:001(A01)[--:MM-Pro 1 ]  
BANK= 083/065
```

If a selected bank is not available, the bank letter indication in the display (A - H) will not change. For a list of the available banks and their MSB/LSB values, refer to the “DX-XG Voice Map” at the back of this manual.

Editing the DX Native Part Parameters (Modular Synthesis Plug-in System)

NOTE

- Keep in mind that the parameter values and settings below represent offsets of the actual voice settings. This means that adjustments made to the parameters may not make much change in the actual sound, depending on the original settings of the voice. For parameter values, a setting of "0" results in no change, while positive and negative values increase and decrease the value respectively.
- The following explanations show how to edit the DX native part parameters when creating PLG voices, using the CS6x Control Synthesizer as an example. For information on storing the PLG voices with your particular Modular Synthesis Plug-in System compatible instrument, refer to the owner's manual of that instrument.

1 Select the desired DX voice, as described in "Selecting DX Voices" on page 22.

2 Press the EDIT button.

The EDIT menu display appears.

```
▼GEN Name) Ctrny      a-Z      0-?  Cursor  
Common                [---:MM-Pno 1 ]
```

3 Turn knob A clockwise until "Elem" is shown at the bottom left of the display.

```
▼OSC Assign)          Bank  Number  
Elem                  ▶083/065    1[MM-Pno 1 ]
```

4 Turn the PAGE knob clockwise until "PLG150-DX" is shown at the bottom left of the display.

Keep turning the knob to select the different DX Part parameters, indicated just above knob C and knob 2.

```
±NTV Param)          Carrier1  Carrier2  
PLG150-DX            ▶+00      ***
```

5 Use knobs C and 2 to select the desired parameter and change the value.

Once one of the parameters is selected (the arrow cursor appears next to the value), you can also adjust the value with the DATA knob or the DEC/INC buttons.

NOTE

- In order to store User voices on a Modular Synthesis Plug-in System compatible instrument that have been edited/created with the computer-based DX Simulator (or with the compatible instrument itself), you'll need to use an external memory device, such as a memory card. For details on storing voices, refer to the owner's manual of your Modular Synthesis Plug-in System compatible instrument.
- The actual parameter names may differ, depending on whether the instrument you are using is XG Plug-in System compatible or Modular Synthesis Plug-in System compatible. For details, refer to the Parameter List (XG / Modular Synthesis Plug-in System).

Selecting/Editing the DX System Parameters (Modular Synthesis Plug-in System)

NOTE The example displays used in the following explanations are all taken from the CS6x.

1 Press the UTILITY button.

The Utility Mode display appears.

↵MSTR TG)	Vol	NoteShift	Tune
Sys	▶127	+ 0 +	0.0c

2 Turn the PAGE knob clockwise until “PLG150-DX” is shown at the bottom left of the display.

Keep turning the knob to select the different DX System parameters, indicated just above knob C and knob 2.

↵PLG1 System)	BulkBlock	VelCurve
PLG150-DX	▶01-32	Normal

3 Use knobs C and 2 to select the desired DX System parameter and change the value.

Once one of the parameters is selected (the arrow cursor appears next to the value), you can also adjust the value with the DATA knob or the DEC/INC buttons.

Selecting DX Voices (XG Plug-in System)

The PLG150-DX voices can be selected just like the voices of the XG tone generator. Keep in mind, though, that they can only be selected when the Sound Module Mode is set to XG or Performance. Also, the Part Assign parameter in the Utility mode (see below) must be set to the desired Part.

NOTE The example displays used in the following explanations are all taken from the MU128.

Enabling and Selecting DX Voices

1 Set the Sound Module Mode to “XG” or “PFM” (Performance).

Press the MODE button and use the SELECT ◀/▶ buttons.

NOTE The Performance mode is not available on the SW1000XG.

2 Set the Part Assign parameter to the desired Part number.

To do this:

- 1) Press the UTIL button.
- 2) Select the “PLUGIN” menu (with the SELECT ▶ button) and press ENTER.
- 3) Select the “PLG150-DX” menu if necessary (with the SELECT ◀/▶ buttons), and press ENTER.
- 4) Select the Part Assign parameter (with the SELECT ◀ button), and use the VALUE +/- buttons or dial to change the Part number.

NOTE The Part Assign range for the XG mode is 1 - 16 and “off”; for the Performance mode, it is 1 - 4 and “off.”

Press the EXIT button to return to the Play mode.

This operation can also be quickly and conveniently done from the DX Easy Editor or DX Simulator (in XGworks).

3 Enable the PLG150-DX board for the desired Part.

First, make sure that the appropriate Part is selected (using the PART +/- buttons), then press the SELECT button. The icon of the selected board appears in the display and the corresponding LED at the bottom of the panel (PLG-1, -2, or -3) flashes briefly.

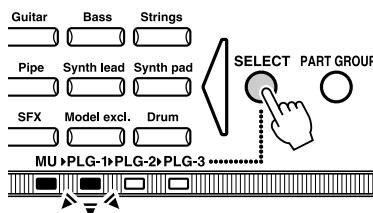

Selecting DX Voices (XG Plug-in System)

4 Select the desired bank number.

Move the cursor to the Bank Number parameter with the SELECT ◀/▶ buttons and use the VALUE -/+ buttons to select the desired bank.

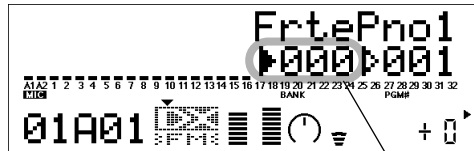

Bank Number parameter

5 Select the desired voice number.

Move the cursor to the Voice (Program) Number parameter with the SELECT ◀/▶ buttons and use the VALUE -/+ buttons to select the desired voice.

NOTE Voices (and Voice banks) can also be selected by using the Voice Category buttons.

Alternately, you can select voices from a connected MIDI keyboard, or from sequencing software (such as XGworks) on a connected computer.

For a list of available voices and their bank/voice numbers, see page 36.

Editing the DX Native Part Parameters (XG Plug-in System)

Any of the DX voices can be freely edited from the front panel with the DX Part parameters. These same parameters can also be edited from a computer using the DX Easy Editor software (in XGworks).

Keep in mind that changing the Part parameters does not permanently affect the original voice settings. The edits that you make here temporarily change the settings of the currently selected voice. When you select a different voice for the Part, the settings are applied to the newly selected voice.



- The Part parameter settings cannot be saved in Multi Play mode. If you wish to save your Part parameter edits, do it from the Performance mode or the DX Easy Editor. If you wish to save your edits to a voice, use the DX Simulator software to edit the parameters of a voice, then save it as a User voice.
- The example displays used in the following explanations are all taken from the MU128.

1 Select the Part having the DX voice, then select the desired voice.

Select the appropriate Part with the PART +/- buttons, then, with the cursor at the Voice Number parameter, select the desired voice.

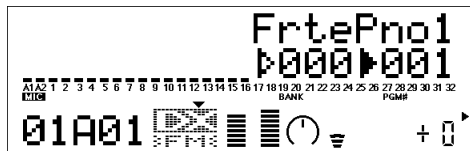

2 Press the EDIT button to enter the Edit mode.



3 Select the "PLUGIN" menu.

Use the SELECT ► button, then press the ENTER button. The PLG150-DX Edit menu appears.



4 Select the desired parameter.

Use the [SELECT ◀▶] buttons.

5 Adjust the value or change the setting for the selected parameter.

Use the [VALUE +/-] buttons.

6 Return to the main Play display.

Press the [EXIT] button several times, or press the [PLAY] button once.

Selecting/Editing the DX System Parameters (XG Plug-in System)

The parameters that apply to the entire system of the PLG150-DX are included in the Utility mode menu of the XG tone generator.

NOTE The example displays used in the following explanations are all taken from the MU128.

1 Press the [UTIL] button.

The Utility mode menu appears.

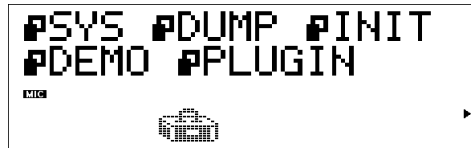

2 Select the “PLUGIN” menu.

Use the [SELECT ►] button to highlight “PLUGIN,” then press the [ENTER] button.



3 Select the PLG150-DX board.

If the PLG150-DX board is the only one installed, “PLG150-DX” is already displayed and can be selected by pressing the [ENTER] button. If additional boards have been installed to the tone generator, you may need to select “PLG150-DX.” To do this, first use the [SELECT ◀▶] buttons, then press [ENTER].

The System parameter menu for the PLG150-DX appears.

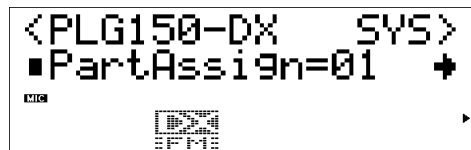

4 Select the desired parameter.

Use the [SELECT ◀▶] buttons.

5 Adjust the value or change the setting for the selected parameter.

Use the [VALUE +/-] buttons.

6 Return to the main Play display.

Press the [EXIT] button several times, or press the [PLAY] button once.

DX Native Part Parameters

Keep in mind that the parameter values and settings represent offsets of the actual voice settings. This means that the actual sound that results from the settings made here depends on the original settings of the voice.

Also keep in mind that these are “Part” parameters and as such, are temporary; they simply alter or offset the settings of the currently selected voice. The original voice settings are permanently maintained in memory.

For parameter values, a setting of “0” results in no change, while positive and negative values increase and decrease the value respectively.

Let’s look at a specific example. If the original Feedback Level parameter of the selected voice is set to +2, and you set the Feedback Level (below) to “-4,” the actual Feedback Level will become “-2.” If you set it to “+1,” the value will become “+3.” Naturally, this also means that the parameter value cannot be increased or decreased beyond its maximum or minimum values. In our example, Feedback values higher than “+5” have no effect on the sound, since the actual range is -7 — +7.



- Depending on the selected voice and the particular parameter being edited, the sound or actual parameter value of certain voices may change very little or not at all, even when the parameter value is changed drastically.
- For Modular Synthesis Plug-in System compatible devices, the voices you edit/create can be stored to the device as PLG voices. For details on storing voices, refer to the owner’s manual of your Modular Synthesis Plug-in System compatible instrument.

■ Carrier1 — Carrier6 (Carrier Operator 1 — 6 Level)

Range: -64 — +63 (“****”: not available)

- This determines the output level of each of the carrier operators. A carrier operator produces the sound for the voice. Changing the output level here changes the level of the voice. When more than one carrier is used in the algorithm, the timbre of the voice is also affected.
- In this parameter, modulators cannot be edited; if a modulator operator is selected, “****” appears in the display and the setting cannot be changed. (To change the modulator operator, use the Modulator 1 — 6 parameter below.) Whether a certain operator is a carrier or not depends on the assigned algorithm of the selected voice. (For a chart showing the operator configurations for all 32 algorithms, see page 34.)

■ Modulator1 — Modulator6 (Modulator Operator 1 — 6 Level)

Range: -64 — +63 (“****”: not available)

- This determines the output level of each of the modulator operators. A modulator operator modulates the operator below it in the algorithm. Changing the output level here changes in the timbre or tonal quality of the voice. Higher levels generally make the sound brighter.
- In this parameter, carriers cannot be edited; if a carrier operator is selected, “****” appears in the display and the setting cannot be changed. (To change the carrier operator, use the Carrier 1 — 6 parameter above.) Whether a certain operator is a modulator or not depends on the assigned algorithm of the selected voice. (For a chart showing the operator configurations for all 32 algorithms, see page 34.)

■ Feedback

Range: -7 — +7

- This determines the level of the feedback loop in the algorithm. Each algorithm provides a feedback operator, in which the output signal of the operator is looped back to its input. As its name implies, Feedback produces harsh noise-like harmonics in the voice. The degree of harshness or amount of noise depends not only on this setting, but also on the level of the feedback operator and its position in the algorithm. (For a chart showing the Feedback configurations for all 32 algorithms, see page 34.)

■ PortaMd (Portamento Mode)

Settings: flw/ftm (Sus-Key P Follow/Full Time Porta)

rtn/fgr (Sus-Key P Retain/Fingered Porta)

- Portamento is an effect that produces a smooth, continuous glide in pitch between two notes (or chords) of different pitches. This parameter determines the way in which portamento is applied, and the settings differ depending on the selected keyboard mode, Mono or Poly.
- When the keyboard is in Mono mode, the available settings are “Fingered Porta” and “Full Time Porta.” Fingered Portamento is glide that occurs only when you play legato — in other words, playing successive notes smoothly, not releasing a previously played note until after the next note is played. Full Time Portamento produces glide from one note to the next even when you play staccato (releasing one note before playing the next).
- When the keyboard is in Poly mode, the available settings are “Sus-Key P Follow” and “Sus-Key P Retain.” In the “Follow” mode, if you play a note or chord and then play another note or chord, the sustain from the original note/chord glides to the pitch of the most recently played note/chord. In the “Retain” mode, the pitch of the new note or chord glides from the original pitch(es) without interrupting the sustain of the original note or chord.

■ PortaStep (Portamento Step)

Range: 0 — 12 (semitones)

- This determines whether the Portamento effect is continuous (setting of “0”), or is a glissando effect, in which the glide in pitch occurs in discrete semitone steps (settings of 1 — 12). This effect is best heard with a slower rate and when two widely separated notes are played one after the other. The value determines the amount of semitones by which the pitch changes. For example, a setting of “1” changes the pitch in semitone steps; for a setting of “12,” the pitch changes in octave jumps.

■ PitBndStep (Pitch Bend Step)

Range: 0 — 12 (semitones)

- This determines the size of the increments by which the Pitch Bend wheel (on a connected MIDI keyboard) changes the pitch. A setting of “0” results in perfectly smooth pitch bending. Values other than “0” represent the number of semitones by which the pitch will “jump” as you move the wheel. For example, the maximum setting of “12” will cause the wheel to change the pitch in a single, one-octave jump.

■ AC4 CC No. (AC4 Controller Assign)

Settings: OFF

MOD (Modulation wheel)
 BC (Breath controller)
 FC (Foot controller)
 EXP (Expression pedal)
 CAT (Channel aftertouch)
 PB (Pitch bend wheel)

- This determines which MIDI controller is to be used for controlling EG Bias (when “AC4CtrPrm1” below is set to “EGbias”).
- When the Amplitude Modulation Sensitivity parameter of a carrier is set to a value other than “0,” this lets you use the selected controller to change the volume in real time. When the Amplitude Modulation Sensitivity parameter of a modulator is set to a value other than “0,” this lets you use the selected controller to change the timbre of the sound in real time. Amplitude Modulation Sensitivity can be edited by using the DX Simulator editing software; see page 19.)

■ AC4CtrPrm1 (AC4 Controller Parameter 1)

Settings: Off, EGbias

- This determines whether the AC4 controller (as set in “AC4 CC No.” above) is used to control EG Bias or not.

■ AC4CtrDpt1 (AC4 Controller Parameter Depth)

Range: -64 — +63

- This determines the depth over which the AC4 controller affects the EG Bias (when “AC4CtrPrm1” above is set to “EGbias”). Negative values produce a reverse action in the controller; for example, for a modulation wheel, moving the wheel down (instead of up) would change the EG Bias.

■ RcvDxSysEx (Receive DX System Exclusive)

Settings: OFF, ON

- The determines whether DX system exclusive messages will be received or not.



The follow conditions must be met for DX system exclusive messages to be received:

With VCED, ACED (Parameter change, Bulk Dump)
 Bulk select: User Bank
 RcvDxSysEx: ON

With VMEM, AMEM: (bulk dump, 32 voice bulk dump)
 RcvDxSysEx: ON

DX System Parameters

■ Part Assign

Settings: 01 — 16, off

- This determines the Part to which the PLG150-DX voice is assigned. If a Part is not properly assigned here, none of the PLG150-DX voices can be selected for the Part. (This applies to XG Plug-in System compatible “mother” devices.)



The PLG150-DX voices can only be assigned to a single Part.

■ BulkBlock

Settings: 01 — 32, 33 — 64

- This determines which User voice memory block (1 — 32, or 33 — 64) will be used when transferring 32-voice bulk data to the PLG150-DX from an external MIDI device or computer.

■ Vel Curve (Velocity Curve)

Settings: DX7, Normal, Soft1, Soft2, Easy, Wide, Hard

- This determines how key velocity (the strength at which the keys are played) affects the volume of the voices. Six different preset velocity “curves” let you quickly tailor the response to your playing preferences.

- **DX7**

This sets the velocity curve for the DX7 and DX7II.

- **Normal**

The volume of the sound changes in direct proportion to the strength at which you play the keyboard.

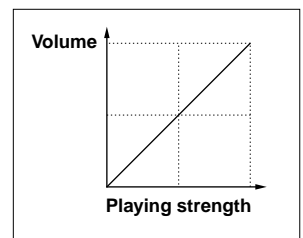

- **Soft1**

Compared to “Normal,” this curve produces greater volume in the soft velocity range, making it suitable for players having a light touch.

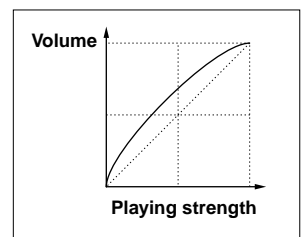

- **Soft2**

This curve also produces greater volume in the soft velocity range, but is less pronounced than “Soft1” above.

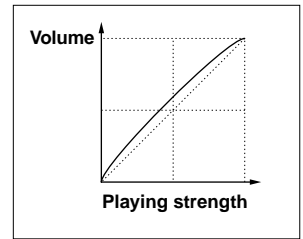

- **Easy**

This curve also produces greater volume in the soft velocity range, but results in a more consistent, stable response throughout the entire velocity range than the other “Soft” curves .

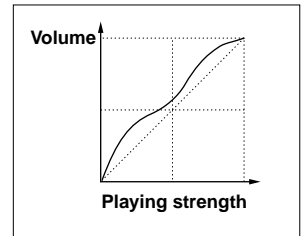

- **Wide**

This curve decreases the volume for softer velocities and increases it for stronger velocities, resulting in a wider dynamic range overall.

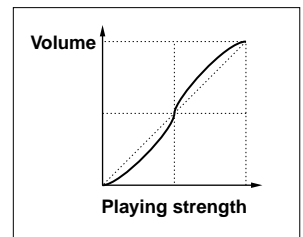

- **Hard**

Compared to “Normal,” this curve produces greater volume in the hard (strong) velocity range, making it suitable for players having a heavy touch.

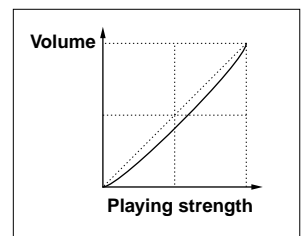

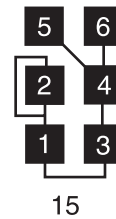
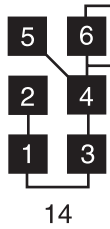
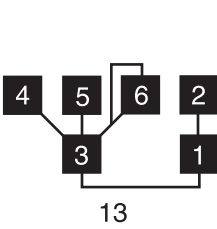
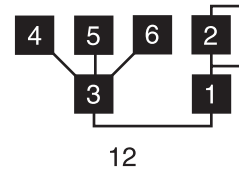
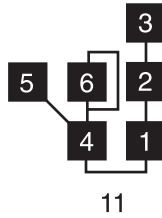
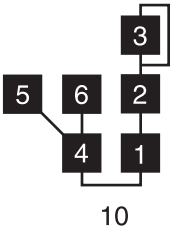
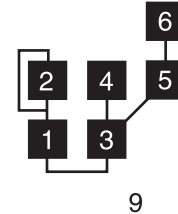
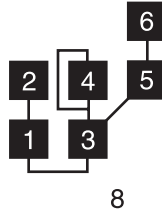
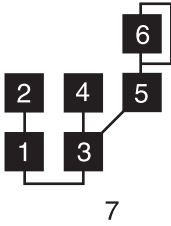
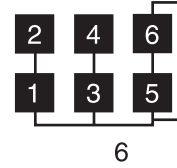
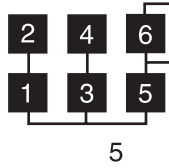
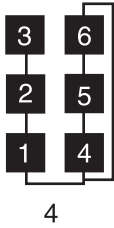
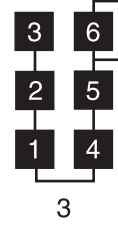
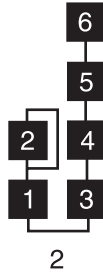
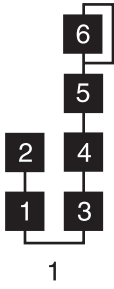

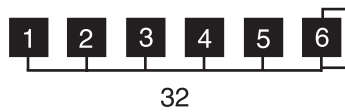
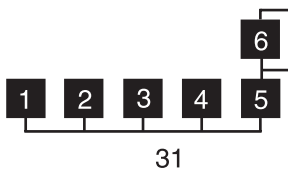
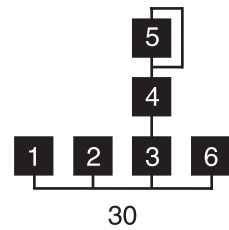
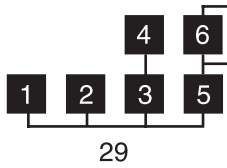
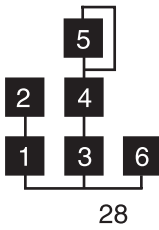
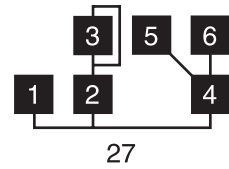
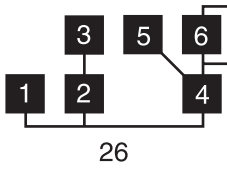
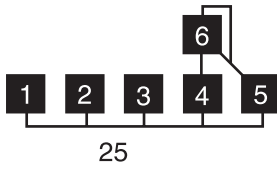
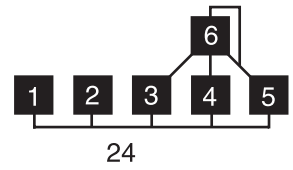
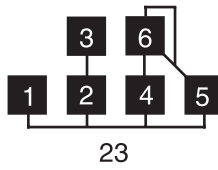
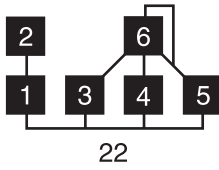
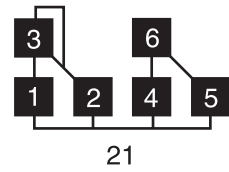
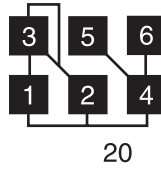
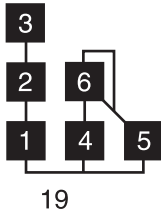
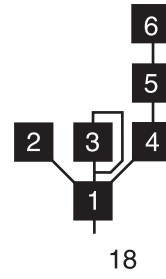
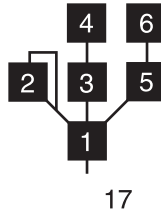
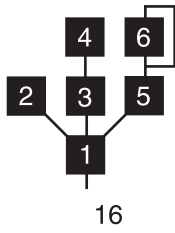

Preset 1 Bank

Bank Select MSB		35			
Bank Select LSB		1			
Instrument Group	Pgm# (1-128)		E	A	B
Piano	1	E.PIANO1	1	5	
	2	E.Pno1	1	5	
	3	ClrE.Pno	1	5	*
	4	E.Pno 2	1	5	
	5	E.Pno 3	1	5	
	6	FulTine1	1	5	
	7	DukeEP	1	5	
	8	BritEP	1	15	
	9	RatioDob	1	5	
	10	PrprdPno	1	9	*
	11	DX-Road1	1	28	
	12	WurliEP1	1	3	*
	13	DX-Road2	1	12	
	14	CosaRosa	1	5	
	15	BritPno1	1	7	
	16	PowerPno	1	3	
	17	DXCP-70	1	4	
	18	HARPSIC1	1	5	
	19	Harpsi 1	1	5	
	20	MM-Clav1	1	4	
	21	SkltmClv	1	18	
	22	ClavStf1	1	18	
Chromatic Percussion	23	MARIMBA	1	7	
	24	DX-Vibe1	1	27	
	25	DX-Vibe2	1	23	
	26	Carillon	1	9	
	27	TUB BELL	1	5	
	28	MiniBell	1	5	
29	SoftBell	1	1		
Bass	30	SmohBass	1	17	
	31	BogiBass	1	16	
	32	SuprBas1	1	17	
	33	DrhtBass	1	16	
	34	DX-SyBa2	1	3	
	35	DX-SyBa3	1	24	
	36	Cutmandu	1	8	
	37	DX-SyBa5	1	3	
	38	DX-SyBa6	1	3	
	39	DX-Bass4	1	18	
	40	DiscBass	1	14	
Guitar	41	Tite Gtr	1	15	
	42	DX-JzGt5	1	8	*
	43	DX-CIGt1	1	9	
	44	DX-CIGt5	1	3	
	45	DetDsGt1	2	-	
Organ	46	FullOrgn	1	32	*
	47	DrwOrg11	1	32	*
	48	DrwOrg14	1	12	
	49	DrwOrg15	1	31	
	50	PrcOrg 3	1	29	
	51	DxJazOr1	1	30	
	52	PrcOrg 4	1	29	*
	53	PrcOrg 5	1	31	*
	54	PrcOrg 8	1	31	
	55	PrcOrg13	1	22	*
	56	PrcOrg15	1	31	*
	57	RckOrg13	1	29	
	58	RckOrg15	1	29	
	59	DXChrch2	1	6	
	60	PipeOrg6	1	19	
	61	DX-Acrd2	1	3	
	62	DX-Acrd4	1	4	*
	63	DX-Hmnc1	1	3	*
64	DX-Hmnc3	1	1		

Preset 2 Bank

Bank Select MSB		35			
Bank Select LSB		2			
Instrument Group	Pgm# (1-128)		E	A	B
Custom	1	BRASS 1	1	22	
	2	BRASS 2	1	22	
	3	BRASS 3	1	18	
	4	STRINGS1	1	2	
	5	STRINGS2	1	2	
	6	STRINGS3	1	15	
	7	ORCHESTR	1	2	
	8	PIANO 1	1	19	
	9	PIANO 2	1	18	
	10	PIANO 3	1	3	
	11	E.PIANO1	1	5	
	12	GUITAR 1	1	8	*
	13	GUITAR 2	1	16	
	14	SYN-LEA1	1	18	
	15	BASS 1	1	16	
	16	BASS 2	1	17	
	17	E.ORGAN1	1	32	
	18	PIPES 1	1	19	
	19	HARPSIC1	1	5	
	20	CLAV 1	1	3	
	21	VIBE 1	1	23	
	22	MARIMBA	1	7	
	23	KOTO	1	2	
	24	FLUTE 1	1	16	*
	25	ORCH-CHI	1	5	
	26	TUB BELL	1	5	
	27	STEEL DR	1	15	
	28	TIMPANI	1	16	
	29	REFS WHI	1	18	
	30	VOICE 1	1	7	*
	31	TRAIN	1	5	*
	32	TAKE OFF	1	10	
	33	PIANO 4	1	18	
	34	PIANO 5	1	3	
	35	E.PIANO2	1	12	
	36	E.PIANO3	1	5	
	37	E.PIANO4	1	5	
	38	PIANO 5T	1	5	
	39	CELESTE	1	31	
	40	TOY PIAN	1	30	*
	41	HARPSIC2	1	3	
	42	HARPSIC3	1	3	
	43	CLAV 2	1	4	
	44	CLAV 3	1	4	
	45	E.ORGAN2	1	29	
	46	E.ORGAN3	1	29	
	47	E.ORGAN4	1	5	
	48	E.ORGAN5	1	29	
	49	PIPES 2	1	3	
	50	PIPES 3	1	25	
	51	PIPES 4	1	6	
	52	CALIOPE	1	16	
	53	ACCORDIO	1	3	
	54	SITAR	1	8	
	55	GUITAR 3	1	14	
	56	GUITAR 4	1	14	
	57	GUITAR 5	1	14	
	58	GUITAR 6	1	3	
	59	LUTE	1	14	
	60	BANJO	1	8	
	61	HARP 1	1	3	*
	62	HARP 2	1	3	*
	63	BASS 3	1	17	*
	64	BASS 4	1	17	

E : Element number A : Algorithm number B : EG Bias (voices with this effect are marked "**")

■ Plug-in Voice List (for CS6x/CS6R/S80)

Pgm# (1-64)	Plug-in Voice Name	KNOB1	KNOB2	MW
1	DX E.Piano	Reverb Send	Chorus Send	AMOD
2	FullTine	Reverb Send	Chorus Send	AMOD
3	Duke EP	Reverb Send	Chorus Send	AMOD
4	RatioDub	Reverb Send	Chorus Send	AMOD
5	DX-Road	AutoPan L/RDpth	AutoPan Speed	AMOD
6	Wurlie EP	Reverb Send	AmpSimulator Drive	AMOD
7	PowerPiano	Reverb Send	Chorus Send	AMOD
8	DX CP-70	Reverb Send	Chorus Send	AMOD
9	SkltN Clav	Reverb Send	AutoWah D/W	AMOD
10	Clav Stf	Reverb Send	TouchWah D/W	AMOD
11	DX Vibe	Reverb Send	Chorus Send	AMOD
12	Mini Bell	Reverb Send	Chorus Send	AMOD
13	Bogi Bass	Comp Threshold	Chorus Send	PMOD
14	Super Bass	AmpSimulator D/W	Chorus Send	PMOD
15	DX Syn Bas	Reverb Send	Chorus Send	PMOD
16	Dirty MW	Overdrive LoGain	Overdrive MidGain	Filter, EG Bias
17	JazzGuitar	Reverb Send	Chorus Send	PMOD
18	TiteGuitar	Reverb Send	Chorus Send	PMOD, AMOD
19	Drw Organ	Reverb Send	Filter	Celeste D/W
20	DX Jazz Or	Reverb Send	Filter	Celeste D/W
21	Perc Organ	Reverb Send	Filter	Celeste D/W
22	DX Acrdion	Reverb Send	Chorus Send	EG Bias
23	DX Harmnca	Reverb Send	Chorus Send	AMOD
24	DX BrsSctn	Reverb Send	Chorus Send	PMOD
25	CS80-Brass	Reverb Send	Flanger D/W	EG Bias
26	MM Brass	Reverb Send	Chorus Send	PMOD, Filter
27	SyntiBrass	Reverb Send	Chorus Send	Filter
28	Syn Horns	Reverb Send	Chorus Send	Filter, EG Bias
29	DX Strings	Reverb Send	Chorus Send	PMOD, Filter
30	Anna Strgs	Reverb Send	Chorus Send	AMOD
31	Small Sect	Reverb Send	Chorus Send	Filter, EG Bias
32	Soline Pf	Reverb Send	Chorus Send	PMOD, AMOD
33	Mystrian	Reverb Send	Exciter Drive	Filter
34	Amethyst	AutoPan L/RDpth	AutoPan Speed	EG Bias
35	Solinex	Reverb Send	Chorus Send	Filter

Pgm# (1-64)	Plug-in Voice Name	KNOB1	KNOB2	MW
36	Ice Galaxy	Reverb Send	Phaser D/W	PMOD, Filter
37	DX Flute	Reverb Send	Chorus Send	AMOD
38	Harvest	Reverb Send	Chorus Send	AMOD, EG Bias
39	DX Solo Ld	AmpSimulator D/W	Chorus Send	PMOD, AMOD
40	Wood Lead	Exciter Drive	Chorus Send	PMOD, AMOD
41	Sing Line	Distortion D/W	Chorus Send	Filter
42	FretlessLd	Distortion D/W	Chorus Send	PMOD
43	Xanu	Reverb Send	Chorus Send	PMOD, AMOD
44	Xango	Reverb Send	Chorus Send	PMOD
45	Rangoon	Celeste FBLevel	Celeste D/W	EG Bias
46	Steel Drum	Reverb Send	Chorus Send	AMOD
47	Stranger	Celeste D/W	Celeste FBLevel	Filter, EG Bias
48	Water Log	Reverb Send	Chorus Send	Filter
49	Moon Choir	Chorus Speed	Chorus Send	Filter, EG Bias
50	Indigo	Overdrive D/W	Overdrive Midwidth	EG Bias
51	Katmandu	Overdrive D/W	Overdrive Drive	Filter
52	Seahorse	Celeste D/W	Celeste FBLevel	EG Bias
53	Rampage	Comp Threshold	Chorus Send	EG Bias
54	Lipstick	Chorus D/W	Chorus FBLevel	Filter
55	Mascara	Flanger D/W	Flanger FBLevel	EG Bias
56	Safe	Comp Attack	Comp Threshold	Filter
57	Ice Cream	Comp Threshold	Comp Ratio	AMOD
58	Panner	AutoPan LoGain	AutoPan Speed	EG Bias
59	Plasma	Chorus Speed	Chorus D/W	Filter
60	Energy	AutoWah Speed	AutoWah D/W	EG Bias, AutoWah Speed
61	SpaceWheel	AutoPan F/RDpth	AutoPan Speed	EG Bias
62	PunchChord	AutoPan F/RDpth	AutoPan Speed	Filter, EG Bias
63	Fast king	Chorus Speed	Chorus D/W	Filter, EG Bias
64	Pointer	Flanger Speed	Flanger D/W	Filter, EG Bias

■ Performance List (for MU128/100/100R)

No.	Name	Type	Notes
1	EP Layer	1 FM + 1 AWM	FM electronic piano layer sound similar to DX1 layer.
2	Doctor DX	1 FM + 1 AWM	FM Electronic piano with a bright, sharp edge.
3	Golden Wires	1 FM + 1 AWM	Features the metallic ring of electronic piano oscillators. For use in performance.
4	SuperConga	1 FM	The percussion sound of a conga, rich in expressiveness.
5	Tubular	1 FM + 1 AWM	FM tubular bells. Velocity change that can't be obtained with FM is added with AWM, giving a velocity cross fade.
6	New Koto	1 FM	Koto sound with an echo effect applied.
7	Cello Edge	1 FM + 1 AWM	Cello rich in expressiveness. The edge of the bow sound is expressed with FM, the natural cello sound with AWM.
8	Plasticlav	1 FM + 1 AWM	A plastic clicking sound is added to a typical clavier.
9	TX Bass	1 FM	A heavy bass sound with good velocity response, like the TX81Z sound.
10	Bachsichord	1 FM + 1 AWM	Harpsichord nuanced with FM's crisp keyboard expression and AWM's realistic sound.
11	That's FM	1 FM + 1 AWM	A bright, FM-like clavier string sound with lots of metallic overtones
12	3D Rodes	1 FM + 1 AWM	A hard electronic piano with a lively click sound and phaser effect added.
13	Mr. Clav	1 FM + 1 AWM	Clavier featuring FM's crispness and attack and AWM's realistic sound.
14	Snooper Bass	1 FM	Bass with a distinct sound that's good for hiphop, rap, or dance music.
15	Digicomp	1 FM	Crisp FM percussive sound with a discordance that appears with as velocity increases. Good for performance.
16	Glasswirl	1 FM	Analog-like FM pad sound rich in expressive power.
17	RealAcoustic	1 FM + 1 AWM	Steel string acoustic guitar. The crisply played feeling comes from FM, while the natural tone generation comes from AWM.
18	SparkleStabs	1 FM	Sparkling percussive pad sound with a slightly metallic feel. Good for music with a new age or pop feeling.
19	Zed Bass	1 FM	TX81Z type bass featuring metallic string sound
20	CE20 Bass	1 FM	FM bass sound like Yamaha's CE20. Good for solo or ensemble use.
21	Harpist	1 FM	Bright harp with a transparent feeling. More effective if played with glissando.
22	Steel Cans	1 FM + 1 AWM	Realistic steel drum sound.
23	Zambeezi	1 FM + 1 AWM	Ethnic sound, like a log drum.
24	Perkethnic	1 FM + 1 AWM	Ethnic drum. Noise is added in relation to velocity.
25	Cembalom	1 FM + 1 AWM	Bright, sparkling FM cembalon (dulcimer)with DK type EG.
26	Smackabass	1 FM	Heavy FM smack bass with distortion.
27	ClockStrikz1	1 FM + 1 AWM	"Big Ben" type bell sound, like TX802 sound.
28	DoubleGlock	1 FM + 1 AWM	Dual voice glockenspiel using FM and AWM.
29	Stage 73	1 FM + 1 AWM	Electric piano with a compressor applied. Undulates as velocity gets stronger.
30	HandBells	1 FM + 1 AWM	FM handbells with realistic AWM effects added.
31	Xylophone	1 FM + 1 AWM	Very natural xylophone.
32	Marimboid	1 FM + 1 AWM	A realistic marimba
33	Vivaldi	1 FM + 2 AWM	Violin created with FM and AWM that can be used for solo or ensemble. Highlights the crispness of FM and the realism of AWM.
34	Industrial	1 FM + 1 AWM	Industrial bass with a good crisp string sound in the attack.
35	2 FD	1 FM + 1 AWM	FM sound that layers bell and electronic piano, like a DX7II FD.
36	Cmprsd Strat	1 FM + 1 AWM	Lively electric guitar sound combining the crispness of FM with the realism of AWM.
37	Uprighteous	1 FM + 1 AWM	Amplified upright bass with FM supplying the feeling of strings being hit.
38	Chackawacka	1 FM + 1 AWM	Percussion sound heard in Chinatown during the Chinese New Year. Discordant sounds add a metallic feeling and string attack as velocity increases.
39	Woodknocker	1 FM + 1 AWM	FM sound with overtones that give a woody feeling, like a cross between a wood drum and bass strings.
40	Temple Gongs	1 FM + 1 AWM	FM gong. If played lightly, it sounds like a gong hit lightly with a rubber mallet. Holding the key makes a metallic sound like brushing the back of the gong.
41	Kundoon	1 FM + 3 AWM	Split sound. The right side of the keyboard sounds like gongs/wind bells played with a bow, the left like a dulcimer.
42	GS1-ness	1 FM + 1 AWM	Strong metallic comp pad sound based on Yamaha's GS1 with deep chorus applied.

No.	Name	Type	Notes
43	Ice Breath	1 FM + 1 AWM	You can hear the breath sounds in this flute that has something of a VL feeling to it.
44	Bronze Lead	1 FM + 1 AWM	Monotone metallic lead/solo sound.
45	Monster Pad	1 FM + 1 AWM	With a dramatic sound just like a movie soundtrack, this pad really catches the flavor of FM.
46	Aluminum	1 FM + 1 AWM	Strong pad with chiff (organ pipe noise) added with metallic overtones.
47	Bite-a-Synth	1 FM + 1 AWM	Really crisp, metallic FM oscillator sound. Good for performance or pad use.
48	Tinezzz	1 FM + 2 AWM	DX piano layered with a nicely ringing pad and with chorus applied.
49	Tam-Tam	1 FM + 1 AWM	Untuned gong sound. By striking multiple keys with a lot of spirit, you can get really good effects.
50	Clickorgan	1 FM + 1 AWM	An organ sound with heavy plastic click in the attack.
51	FreshSection	1 FM + 3 AWM	Fresh sax section. Play it crisply.
52	Ascension	1 FM + 2 AWM	Sounds like a magic spell being cast.
53	Better Days	1 FM + 2 AWM	Makes an eerie noise. Play one note at a time.
54	Touch me!!	1 FM + 1 AWM	That stereo feeling just shines (old electronic mandolin sound).
55	Blue Mirror	1 FM + 3 AWM	Quivering bell sound.
56	FlameSwaying	1 FM + 3 AWM	Swaying sound of the harp.
57	Spring Bass	1 FM + 3 AWM	Synth bass with a hard attack.
58	Vintage Game	1 FM + 3 AWM	The so-called electronic sound.
59	From a Home	1 FM + 3 AWM	The old family organ has gone hi-fi.
60	Danger Caves	1 FM + 3 AWM	Play it from below-as dark as can be.
61	Afternoon Jam	1 FM + 3 AWM	Guitar and vibraphone played in unison.
62	HappyEnd	1 FM + 2 AWM	An old organ. Play it dramatically.
63	Fantasy Songs	1 FM + 3 AWM	A perfect voice for playing Disney songs.
64	Relax Square	1 FM + 3 AWM	Synth chorus voice.
65	Coriander	1 FM + 3 AWM	Well-matched voice for ethnic songs.
66	Drive Bass	1 FM + 3 AWM	Synth bass with a special attack.
67	LoFi Clavi	1 FM + 2 AWM	Voice like a 70's distorted clavier.
68	ColdWater-DX	1 FM + 3 AWM	A voice with refreshing DX clarity.
69	HiSpeedBrass	1 FM + 3 AWM	Live brass section with a stereo feeling.
70	Ambient Park	1 FM + 3 AWM	Soft Pad.
71	Picked CP	1 FM + 2 AWM	Electric piano that sounds like an electric grand played with a pick.
72	Sand Pad	1 FM + 2 AWM	Warm synth pad with layered DX strings and chorus.
73	DX-Brass1	1 FM + 2 AWM	Brass that emphasizes the hard attack of the trumpet.
74	DX-Brass2	1 FM + 1 AWM	Brass with the unique tension of the DX7.
75	Plucked Wow	1 FM	DX clavinet with auto-wow applied.
76	Plucked EP	1 FM + 2 AWM	Electric piano that sounds like a harp.
77	Brass Pad	1 FM + 1 AWM	Analog synth style brass pad.
78	Octave Decay	1 FM	Hard decay sound.
79	Slap Bass	1 FM + 1 AWM	Slap bass as only the DX7 can do it.
80	Ethnic Groove	1 FM + 1 AWM	Ethnic synth drum.
81	Thai Noodles	1 FM + 1 AWM	A lead voice that makes you want to eat Thai noodles.
82	ElectrcNylon	1 FM + 1 AWM	A nylon guitar played though a pick-up.
83	DX Martenot	1 FM	Martenot style voice that's classic for suspense.
84	CP80M+DX Ep	1 FM + 1 AWM	Voice with layered CP80M and DX electric piano.
85	Viscous Bass	1 FM + 1 AWM	Gluey synth bass sound.
86	Woody Plucked	1 FM + 1 AWM	Plucked sound with a woody feel.
87	Arco Strings	1 FM + 1 AWM	String section played with bows.
88	Matrix	1 FM + 1 AWM	Thick synth brass pad.
89	PanFlute	1 FM + 2 AWM	Pan flute
90	DigiMute	1 FM + 1 AWM	DX-like mute.
91	DigiSlap	1 FM + 1 AWM	Hard synth bass.
92	SuperDX	1 FM + 1 AWM	Hard slap bass style lead.
93	Friction	1 FM + 2 AWM	Brass pad with a hard friction feel.
94	Comped EP	1 FM + 2 AWM	Percussive electric piano.
95	Clean Guitar	1 FM + 1 AWM	Electric guitar played with a guitar amp that has chorus.
96	Mandolin	1 FM + 1 AWM	Mandolin that brings back memories of good old movies.
97	Reed-Lead	1 FM + 1 AWM	Digital sax-style lead
98	BigBang	1 FM + 2 AWM	SE-type pad that has an attack with a lot of violent modulation.
99	DX-Bang!	1 FM + 2 AWM	SE-type pad that has an attack with a lot of violent modulation.
100	OrinocoDecay	1 FM + 2 AWM	Sound for arpeggio with an attack like a marimba, and like a guitar used with orinoco flow.

DX Parameter List (XG / Modular Synthesis Plug-in System)

Modular Synthesis Plug-in System	XG Plug-in System	(LCD of CS6x/CS6R/S80/etc.)
----------------------------------	-------------------	-----------------------------

(Common Parameter)

Parameter Name	Parameter Name	Group	Parameter
Volume	VOLUME	QED*Level	Vol
Pan	PAN	QED*Level	Pan
Reverb Send	REVERB SEND	QED*Level	RevSend
Chorus Send	CHORUS SEND	QED*Level	ChoSend
LPF Cutoff Frequency	LOW PASS FILTER CUTOFF FREQUENCY	QED*Filter	Cutoff
LPF Resonance	LOW PASS FILTER RESONANCE	QED*Filter	Reso
Attack Time	EG ATTACK TIME	QED*EG	Attack
Decay Time	EG DECAY TIME	QED*EG	Decay
Release Time	EG RELEASE TIME	QED*EG	Release
Pitch Bend Range	BEND PITCH CONTROL	CTL*Pitch	Pitch Bend
Portamento Switch	PORTAMENTO SWITCH	CTL*Pitch	Portamento
Portamento Time	PORTAMENTO TIME	CTL*Pitch	Time
Mono/Poly Mode	MONO/POLY MODE	GEN*Other	Mode
Same Note Number Key On Assign	SAME NOTE NUMBER KEY ON ASSIGN	GEN*Other	Assign

(Element Parameter)

Parameter Name	Parameter Name	Group	Parameter
Plug-in Board Voice Bank MSB	BANK SELECT MSB	PLG*Assign	Bank
Plug-in Board Voice Bank LSB	BANK SELECT LSB	PLG*Assign	Bank
Plug-in Board Voice Program Number	PROGRAM NUMBER	PLG*Assign	Number
Note Shift	NOTE SHIFT	PLG*Velocity	NoteSft
Velocity Sense Depth	VELOCITY SENSE DEPTH	PLG*Velocity	Depth
Velocity Sense Offset	VELOCITY SENSE OFFSET	PLG*Velocity	Offset
Pitch EG Initial Level	PITCH EG INITIAL LEVEL	PCH*PEG	InitLvl
Pitch EG Attack Time	PITCH EG ATTACK TIME	PCH*PEG	Attack
Pitch EG Release Level	PITCH EG RELEASE LEVEL	PCH*PEG	---Level
Pitch EG Release Time	PITCH EG RELEASE TIME	PCH*PEG	Release
LFO Rate	VIBRATO RATE	LFO Param	Speed
LFO Pitch Modulation Depth	VIBRATO DEPTH	LFO Param	PMod
LFO Delay	VIBRATO DELAY	LFO Param	Delay
HPF Cutoff Frequency	HIGH PASS FILTER CUTOFF FREQUENCY	QED*Filter	HPF
EQ Low Gain	EQ BASS GAIN	EQ*Param	LoGain
EQ High Gain	EQ TREBLE GAIN	EQ*Param	HiGain
EQ Low Frequency	EQ BASS FREQUENCY	EQ*Param	LoFreq
EQ High Frequency	EQ TREBLE FREQUENCY	EQ*Param	HiFreq

MW Filter Control	MW LOW PASS FILTER CONTROL	CTL*MW Control	Filter
MW LFO Pitch Modulation Depth	MW LFO PMOD DEPTH	CTL*MW Modulation	PMod
MW LFO Filter Modulation Depth	MW LFO FMOD DEPTH	CTL*MW Modulation	FMod
MW LFO Amplitude Modulation Depth	MW LFO AMOD DEPTH	CTL*MW Modulation	AMod
CAT Pitch Control	CAT PITCH CONTROL	CTL*AT Control	Pitch
CAT Filter Control	CAT LOW PASS FILTER CONTROL	CTL*AT Control	Filter
CAT LFO Pitch Modulation Depth	CAT LFO PMOD DEPTH	CTL*AT Modulation	PMod
CAT LFO Filter Modulation Depth	CAT LFO FMOD DEPTH	CTL*AT Modulation	FMod
CAT LFO Amplitude Modulation Depth	CAT LFO AMOD DEPTH	CTL*AT Modulation	AMod
AC1 Controller Number	AC1 CONTROLLER NUMBER	CTL*AC Control	Source
AC1 Filter Control	AC1 LOW PASS FILTER CONTROL	CTL*AC Control	Filter
AC1 LFO Pitch Modulation Depth	AC1 LFO PMOD DEPTH	CTL*AC Modulation	PMod
AC1 LFO Filter Modulation Depth	AC1 LFO FMOD DEPTH	CTL*AC Modulation	FMod
AC1 LFO Amplitude Modulation Depth	AC1 LFO AMOD DEPTH	CTL*AC Modulation	AMod

MIDI Data Format

1. Channel messages

1.1 Note on/note off

These messages convey keyboard performance data.

Range of note numbers received = C-2...G8

Velocity range = 1...127 (Velocity is received only for note-on)

When the Multi Part parameter "Rcv NOTE MESSAGE" = OFF, that part will not receive these messages.

1.2 Control changes

These messages convey control operation information for volume or pan etc.

Their functions are differentiated by the control number (Ctrl#).

If the Multi Part parameter Rcv CONTROL CHANGE = OFF, that part will not receive control changes.

1.2.1 Bank Select

This message selects the voice bank.

Control#	Parameter	Data Range
0	Bank Select MSB	0...127
32	Bank Select LSB	0...127

The Bank Select data will be processed only after a Program Change is received, and then voice bank will change at that time. If you wish to change the voice bank as well as the voice, you must transmit Bank Select and Program Change messages as a set, in the following order: Bank Select MSB, LSB, and Program Change.

1.2.2 Modulation

This message is used primarily to control the depth of vibrato, but the depth of the following 6 types of effect can be controlled. The effect of this message can be changed by the following parameters.

* Multi Part Parameter

1. MW PITCH CONTROL
2. MW FILTER CONTROL
3. MW AMPLITUDE CONTROL
4. MW LFO PMOD DEPTH
5. MW LFO AMOD DEPTH

By default, an LFO Pitch Modulation (PMOD) effect will apply.

Control#	Parameter	Data Range
1	Modulation	0...127

If the Multi Part parameter Rcv MODULATION = OFF, that part will not receive Modulation.

1.2.3 Portamento Time

This message controls the degree of Portamento (see 1.2.9).

Control#	Parameter	Data Range
5	Portamento Time	0...127

When Portamento is ON, this regulates the speed of the pitch change. A value of 0 is the shortest Portamento time, and 127 is the longest Portamento time.

1.2.4 Data Entry

This message sets the value of the parameter which was specified by RPN (see 1.2.17) and NRPN (see 1.2.16).

Control#	Parameter	Data Range
6	Data Entry MSB	0...127
38	Data Entry LSB	0...127

1.2.5 Main Volume

This message controls the volume of each part. (It is used to adjust the volume balance between parts.)

Control#	Parameter	Data Range
7	Main Volume	0...127

When the Multi Part parameter Rcv VOLUME = OFF, that part will not receive Main Volume. With a value of 0 there will be no sound, and a value of 127 will produce the maximum volume.

1.2.6 Panpot

This message controls the panning (stereo location) of each part.

Control#	Parameter	Data Range
10	Pan	0...64...127

When the Multi Part parameter Rcv PAN = OFF, that part will not receive Panpot. 0 is left, 64 is center, and 127 is right.

1.2.7 Expression

This message controls expression for each part. It is used to create volume changes during a song.

Control#	Parameter	Data Range
11	Expression	0...127

If the Multi Part parameter Rcv EXPRESSION = OFF, that part will not receive Expression.

1.2.8 Hold1

This message controls sustain pedal on/off.

Control#	Parameter	Data Range
64	Hold1	0...63, 64...127 (OFF, ON)

When this is ON, currently-sounding notes will continue to sound even if note-off messages are received. If the Multi Part parameter Rcv HOLD1 = OFF, that part will not receive Hold1.

1.2.9 Portamento

This message controls Portamento pedal on/off.

Control#	Parameter	Data Range
65	Portamento	0...63, 64...127 (OFF, ON)

When ON, Portamento produces a smooth glide connecting two notes of different pitch. The time over which the pitch changes is adjusted by Portamento Time (see 1.2.3). When the Multi Part Parameter MONO/POLY MODE = MONO, the tone will also change smoothly (legato) if Portamento = ON.

If the Multi Part parameter Rcv PORTAMENTO = OFF, that part will not receive Portamento.

* Rcv PORTAMENTO = OFF

1.2.10 Sostenuto

This message controls sostenuto pedal on/off.

Control#	Parameter	Data Range
66	Sostenuto	0...63, 64...127 (OFF, ON)

If sostenuto is turned on while a note is sounding, that note will be sustained until sostenuto is turned OFF.

If the Multi Part parameter Rcv SOSTENUTO = OFF, that part will not receive Sostenuto.

1.2.11 Harmonic Content

This message adjusts the resonance of the filter that is specified for the sound.

Control#	Parameter	Data Range
71	Harmonic Content	0...64...127 (-64...0...+63)

Since this is a relative change parameter, it specifies an increase or decrease relative to 64. Higher values will produce a more distinctive sound.

For some sounds, the effective range may be less than the possible range of settings.

1.2.12 Release Time

This message adjusts the EG release time that was specified by the sound data.

Control#	Parameter	Data Range
72	Release Time	0...64...127 (-64...0...+63)

Since this is a relative change parameter, it specifies an increase or decrease relative to 64. Increasing this value will lengthen the release time that follows a note-off.

1.2.13 Attack Time

This message adjusts the EG attack time that was specified by the sound data.

Control#	Parameter	Data Range
73	Attack Time	0...64...127 (-64...0...+63)

Since this is a relative change parameter, it specifies an increase or decrease relative to 64. Increasing this value will make the attack more gradual, and decreasing this value will make the attack sharper.

1.2.14 Brightness

This message adjusts the cutoff frequency of the low pass filter specified by the sound data.

Control#	Parameter	Data Range
74	Brightness	0...64...127 (-64...0...+63)

Since this is a relative change parameter, it specifies an increase or decrease relative to 64. Lower values will produce a more mellow sound.

For some sounds, the effective range may be less than the possible range of settings.

1.2.15 Data Increment/Decrement (for RPN)

This message is used to increment or decrement values for parameters specified by RPN (see 1.2.17), in steps of 1.

Control#	Parameter	Data Range
96	RPN Increment	—
97	RPN Decrement	—

The data byte is ignored.

1.2.16 NRPN (Non-registered parameter number)

This is a message for setting the sound for things like vibrato, filter or EG. Use NRPN MSB and NRPN LSB to specify the parameter that you wish to modify, and then use Data Entry (see 1.2.4) to set the value for the specified parameter.

Control#	Parameter	Data Range
98	NRPN LSB	0...127
99	NRPN MSB	0...127

If the Multi Part parameter Rcv NRPN = OFF, that part will not receive NRPN.

The following NRPN messages can be received.

NRPN	Data Entry*1		Parameter Name and Data Range
	MSB	LSB	
01H 08H	mm	--*2	Vibrato rate mm: 00H - 40H - 7FH (-64 ...0...+63)
01H 09H	mm	--	Vibrato depth mm: 00H - 40H - 7FH (-64 ...0...+63)
01H 0AH	mm	--*3	Vibrato delay mm: 00H - 40H - 7FH (-64 ...0...+63)
01H 20H	mm	--	Low pass filter cutoff frequency mm: 00H - 40H - 7FH (-64 ...0...+63)
01H 24H	mm	--	High pass filter cutoff frequency mm: 00H - 40H - 7FH (-64 ...0...+63)
01H 30H	mm	--	EQ bass gain mm: 00H - 40H - 7FH (-64 ...0...+63)
01H 31H	mm	--	EQ treble gain mm: 00H - 40H - 7FH (-64 ...0...+63)
01H 34H	mm	--	EQ bass frequency mm: 04H - 28H (32 ... 2.0K [Hz])
01H 35H	mm	--	EQ treble frequency mm: 1CH - 3AH (500 ... 16.0K [Hz])
01H 63H	mm	--	EG Attack Time mm: 00H - 40H - 7FH (-64 ...0...+63)
01H 64H	mm	--	EG Decay Time mm: 00H - 40H - 7FH (-64 ...0...+63)
01H 66H	mm	--	EG Release Time mm: 00H - 40H - 7FH (-64 ...0...+63)

*1 See 1.2.4

*2 "--" means that the set value will be ignored.

*3 Adjusts the time after the note is played until vibrato begins to take effect. The effect will begin more quickly for lower values, and more slowly for higher values.

1.2.17 RPN (Registered parameter number)

This message is used to specify part parameters such as Pitch Bend Sensitivity or Tuning. Use RPN MSB and RPN LSB to specify the parameter that you wish to modify, and then use Data Entry (see 1.2.4) to set the value of the specified parameter.

Control#	Parameter	Data Range
100	RPN LSB	0 ... 127
101	RPN MSB	0 ... 127

If the Multi Part parameter Rcv RPN = OFF, that part will not receive this message.

The following RPN messages can be received.

RPN	Data Entry *1		Parameter Name and Value Range
	MSB	LSB	
00 00H	mm	--*2	Pitch bend sensitivity mm: 00-18H (0...+24 semitones) Specify up to 2 octaves in semitone steps
00 01H	mm	ll	Fine tuning mm ll: 00H 00H -100 cents : : mm ll: 40H 00H 0 cents : : mm ll: 7FH 7FH +100 cents Note: The next after mm ll: 00H 7FH (= -87.5) cent is 01H 00H (-87.4) cents.
00H 02H	mm	--	Coarse tuning mm: 28H - 40H - 58H (-24...0...+24 semitones)
7FH 7FH	--	--	RPN Null This empties settings from RPN and NRPN numbers. Internal data is not affected.

*1 Refer to 1.2.4

*2 "--" means that the set value will be ignored.

1.2.18 Assignable controller

By assigning a control change number of 0...95 to a part, application of effects can be controlled. This device allows two control change numbers (AC1 and AC2) to be specified for each part.

The following parameters specify the effect of AC1 and AC2:

* Multi Part Parameter

- AC1, AC2 PITCH CONTROL
- AC1, AC2 FILTER CONTROL
- AC1, AC2 AMPLITUDE CONTROL
- AC1, AC2 LFO PMOD DEPTH
- AC1, AC2 LFO AMOD DEPTH

The AC1 control change number is specified by the Multi Part parameter AC1 CONTROLLER NUMBER, and the AC2 control change number is specified by the Multi Part parameter AC2 CONTROLLER NUMBER.

1.3 Channel mode messages

These messages specify the basic operation of a part.

1.3.1 All Sound Off

This message silences all notes being played on the corresponding channel. However, channel messages such as Note-on and Hold-on will be maintained in their present state.

Control#	Parameter	Data Range
120	All Sound Off	0

1.3.2 Reset All Controllers

This message changes the settings of the following controllers.

Controller	Value
Pitch bend change	±0 (Center)
Channel pressure	0 (OFF)
Polyphonic key pressure	0 (OFF)
Modulation	0 (OFF)
Expression	127 (Max.)
Hold	0 (OFF)
Portamento	0 (OFF)
Sostenuto	0 (OFF)
RPN	Number unset, internal data is not affected.
NRPN	Number unset, internal data is not affected.

The following data is not changed

Parameter values specified for program change, bank select MSB/LSB, volume, pan, effect send levels 1, 3, 4, RPN and NRPN.

Control#	Parameter	Data Range
121	Reset All Controllers	0

1.3.3 All Note Off

This message turns off all notes which are currently on for the corresponding part. However, if Hold 1 or Sostenuto are on, notes will continue to sound until these are turned off.

Control#	Parameter	Data Range
123	All Note Off	0

1.3.4 Omni Off

Works the same as when All Note Off is received.

Control#	Parameter	Data Range
124	Omni Off	0

1.3.5 Omni On

Works the same as when All Note Off is received.

Control#	Parameter	Data Range
125	Omni On	0

1.3.6 Mono

Works the same as when All Sound Off is received, and if the value (mono number) is in the range of 0... 16, sets the corresponding channel to Mode4* (m = 1).

Control#	Parameter	Data Range
126	Mono	0 ... 16

* Mode4 is a state in which only channel messages on the specified channel will be received, and notes will be played individually (monophonically).

1.3.7 Poly

Works the same as when All Sound Off is received, and sets the corresponding channel to Mode3*.

Control#	Parameter	Data Range
127	Poly	0

* Mode3 is when channel messages will be received only on the specified channel, and notes will be sounded polyphonically.

1.4 Program change

This message is used to switch voices.

It changes the program number on the receiving channel. When the change is to include the voice bank, transmit the program change after sending the Bank Select message (see 1.2.1).

If the Multi Part parameter Rcv PROGRAM CHANGE = OFF, that part will not receive program changes.

1.5 Pitch bend

This message conveys information on pitch bend operations.

Basically, this message is for changing the pitch of a part, but the depth of the following five effects can be controlled.

The effect of this message can be modified by the following parameters.

- * Multi Part Parameter
- 1. BEND PITCH CONTROL
- 2. BEND FILTER CONTROL
- 3. BEND AMPLITUDE CONTROL
- 4. BEND LFO PMOD DEPTH
- 5. BEND LFO AMOD DEPTH

By default, the Pitch Control effect is applied.

If the Multi Part parameter Rcv PITCH BEND CHANGE = OFF, that part will not receive pitch bend messages.

1.6 Channel aftertouch

This message conveys the pressure after the key is played on the keyboard (for an entire MIDI channel). The pressure can be controlled for each part. This message will affect the notes currently playing.

The effect of this message can be modified by the following parameters.

- * Multi Part Parameter
- 1. CAT PITCH CONTROL
- 2. CAT FILTER CONTROL
- 3. CAT AMPLITUDE CONTROL
- 4. CAT LFO PMOD DEPTH
- 5. CAT LFO AMOD DEPTH

By default, there will be no effect.

If the Multi Part parameter Rcv CHANNEL AFTER TOUCH = OFF, that part will not receive Channel Aftertouch.

1.7 Polyphonic aftertouch

This message conveys the pressure after the key is played on the keyboard (for individual note numbers). The pressure can be controlled for each part. This message will affect the notes currently playing.

The effect of this message is determined by the following Multi Part parameters.

- 1. PAT PITCH CONTROL
- 2. PAT AMPLITUDE CONTROL
- 3. PAT LFO PMOD DEPTH
- 4. PAT LFO AMOD DEPTH

By default, there will be no effect.

If the Multi Part parameter Rcv POLY AFTER TOUCH = OFF, that part will not receive Polyphonic Aftertouch.

2. System exclusive messages

2.1 Parameter changes

This device uses the following parameter changes.

[UNIVERSAL REALTIME MESSAGE]

1) Master Volume

[UNIVERSAL NON REALTIME MESSAGE]

1) General MIDI System On

[XG PARAMETER CHANGE]

- 1) XG System on
- 2) XG System parameter change
- 3) Multi Part parameter change

[PLG150-DX NATIVE PARAMETER CHANGE]

- 1) PLG150-DX System parameter change
- 2) PLG150-DX Multi Part parameter change

[DX PARAMETER CHANGE]

- 1) VCED parameter change
- 2) ACED parameter change

2.1.1 Universal realtime messages

2.1.1.1 Master Volume

11110000	F0H	= Exclusive status
01111111	7FH	= Universal Real Time
01111111	7FH	= ID of target device
00000100	04H	= Sub-ID #1=Device Control Message
00000001	01H	= Sub-ID #2=Master Volume
* 0sssssss	SSH	= Volume LSB
0ttttttt	TTH	= Volume MSB
11110111	F7H	= End of Exclusive
11110000	F0H	= Exclusive status
01111111	7FH	= Universal Real Time
0xxxxnnn	XNH	= Device Number, xxx = don't care
00000100	04H	= Sub-ID #1=Device Control Message
00000001	01H	= Sub-ID #2=Master Volume
0sssssss	SSH	= Volume LSB
0ttttttt	TTH	= Volume MSB
11110111	F7H	= End of Exclusive

When received, the Volume MSB is reflected in the System Parameter MASTER VOLUME.

* The binary expression 0sssssss is expressed in hexadecimal as SSH. The same applies elsewhere.

2.1.2 Universal non-realtime messages

2.1.2.1 General MIDI System On

11110000	F0H	= Exclusive status
01111110	7EH	= Universal Non-Real Time
01111111	7FH	= ID of target device
00001001	09H	= Sub-ID #1=General MIDI Message
00000001	01H	= Sub-ID #2=General MIDI On
11110111	F7H	= End of Exclusive
or		
11110000	F0H	= Exclusive status
01111110	7EH	= Universal Non-Real Time
0xxxxnnn	XNH	= N:Device Number, X:don't care
00001001	09H	= Sub-ID #1=General MIDI Message
00000001	01H	= Sub-ID #2=General MIDI On
11110111	F7H	= End of Exclusive

When this message is received, the SOUND MODULE MODE is set to XG, and all data except for MIDI Master Tuning will be restored to the default value.

However this message will not be received when SOUND MODULE MODE = C/M.

Since approximately 50ms is required to process this message, be sure to allow an appropriate interval before sending the next message.

2.1.3 XG Parameter Change

This message sets XG-related parameters. Each message can set a single parameter.

The message format is as follows.

11110000	F0H	Exclusive status
01000011	43H	YAMAHA ID
0001nnnn	1NH	N:device Number
01001100	4CH	Model ID
0ggggggg	GGH	Address High
0mmmmmmm	MMH	Address Mid
01111111	LLH	Address Low
0vvvvvvv	VVH	Data
:	:	:
11110111	F7H	End of Exclusive

For parameters whose Data Size is 2 or 4, the appropriate amount of data will be transmitted as indicated by Size.

2.1.3.1 XG System On

11110000	F0H	Exclusive status
01000011	43H	YAMAHA ID
0001nnnn	1NH	N:device Number
01001100	4CH	Model ID
00000000	00H	Address High
00000000	00H	Address Mid
01111110	7EH	Address Low
00000000	00H	Data
11110111	F7H	End of Exclusive

When ON is received, the SOUND MODULE MODE changes to XG. Since approximately 50ms is required to process this message, be sure to allow an appropriate interval before sending the next message.

2.1.3.2 XG System parameter change

This message sets the XG SYSTEM block (see Tables <1-1> and <1-2>).

2.1.3.3 Multi Part parameter change

This message sets the Multi Part block (see Tables <1-1> and <1-3>).

2.1.4 PLG150-DX Native parameter change

This message sets parameters unique to the PLG150-DX.

Each message can set a single parameter. The message format is as follows.

11110000	F0H	Exclusive status
01000011	43H	YAMAHA ID
0001nnnn	1NH	N:Device Number
01100010	62H	Model ID
0ggggggg	GGH	Address High
0mmmmmmm	MMH	Address Mid
01111111	LLH	Address Low
0vvvvvvv	VVH	Data
:	:	:
11110111	F7H	End of Exclusive

For parameters whose Data Size is 2 or 4, the appropriate amount of data will be transmitted as indicated by Size.

2.1.4.1 PLG150-DX Native System parameter change

This message sets the PLG150-DX SYSTEM block (see Tables <2-1> and <2-2>).

2.1.4.2 PLG150-DX Native Part parameter change

This message sets the PLG150-DX MULTI PART block (see Tables <2-1> and <2-3>).

2.1.5 DX Parameter Change

11110000	F0H	Exclusive status
01000011	43H	YAMAHA ID
0001nnnn	1NH	N:Device Number
0ggggghh	GGH	Parameter Group No.
0ppppppp	PPH	Parameter No.
0vvvvvvv	VVH	Data
11110111	F7H	End of Exclusive

2.1.5.1 VCED parameter change

This message sets the VCED block (see Tables <3-1> and <3-2>).

2.1.5.2 ACED parameter change

This message sets the ACED block (see Tables <3-1> and <3-3>).

2.2 Bulk dump

This device uses only the following bulk dump messages.

[XG BULK DUMP]

- 1) XG System bulk dump
- 2) Multi Part bulk dump

[PLG150-DX NATIVE BULK DUMP]

- 1) Native System bulk dump
- 2) Multi Part bulk dump

[DX BULK DUMP]

- 1) VCED
- 2) ACED
- 3) VMEM
- 4) AMEM

2.2.1 XG bulk dump

This message sets XG-related parameters. Unlike parameter change messages, a single message can modify multiple parameters. This message format is as follows.

11110000	F0H	Exclusive status
01000011	43H	YAMAHA ID
0000nnnn	0NH	N:Device Number
01001100	4CH	Model ID
0sssssss	SSH	ByteCountMSB
0ttttttt	TTH	ByteCountLSB
0ggggggg	GGH	Address High
0mmmmmmm	MMH	Address Mid
01111111	LLH	Address Low
0vvvvvvv	VVH	Data
:	:	:
0kkkkkkk	KKH	Check-sum
11110111	F7H	End of Exclusive

Address and Byte Count are given in tables <1-n>.

Byte Count is indicated by the total size of the Data in tables <1-n>.

Bulk dump is received when the beginning of the block is specified in "Address."

"Block" indicates the unit of the data string that is indicated in tables <1-n> as "Total Size."

Check sum is the value that produces a lower 7 bits of 0 when this Start Address, Byte Count, Data, and the Check sum itself are added.

2.2.1.1 XG System bulk dump

This message sets the XG SYSTEM block (see Tables <1-1> and <1-2>).

2.2.1.2 Multi Part bulk dump

This message sets the MULTI PART block (see Tables <1-1> and <1-3>).

2.2.2 PLG150-DX Native Bulk Dump

This message sets the special parameters for PLG150-DX.

Unlike Parameter change, one message can modify multiple parameters.

11110000	F0H	Exclusive status
01000011	43H	YAMAHA ID
0000nnnn	0NH	N:Device Number
01100010	62H	Model ID
0sssssss	SSH	ByteCountMSB
0ttttttt	TTH	ByteCountLSB
0ggggggg	GGH	Address High
0mmmmmmm	MMH	Address Mid
01111111	LLH	Address Low
0vvvvvvv	VVH	Data
:	:	:
0kkkkkkk	KKH	Check-sum
11110111	F7H	End of Exclusive

The detail are the same as for 2.2.1 XG Bulk Dump. However, see Tables <2-n> for the Address, Byte, Count, and block.

2.2.2.1 PLG150-DX Native System bulk dump

This message sets the PLG150-DX SYSTEM block (see Tables <2-1> and <2-2>).

2.2.2.2 PLG150-DX Multi Part bulk dump

This message sets the PLG150-DX Multi Part block (see Tables <2-1> and <2-3>).

2.2.3 DX bulk dump

11110000	F0H	Exclusive status
01000011	43H	YAMAHA ID
0000nnnn	0NH	N:Device Number
0ttttttt	TTH	Format No.
0sssssss	SSH	ByteCountMSB
0ttttttt	TTH	ByteCountLSB
0vvvvvvv	VVH	Data
:	:	:
0kkkkkkk	KKH	Check-sum
11110111	F7H	End of Exclusive

Address and Byte Count are given in tables <3-n>. Byte Count is indicated by the total size of the Data in tables <4-n>.

Bulk dump is received when the beginning of the block is specified in "Address."

"Block" indicates the unit of the data string that is indicated in tables 3-n as "Total size".

Check sum is the value that produces a lower 7 bits of 0 when the DATA, and the Check-sum itself are added.

2.2.3.1 VCED Bulk Dump

This message sets the VCED block (see Tables <4-1> and <3-2>).

2.2.3.2 ACED Bulk Dump

This message sets the ACED block (see Tables <4-1> and <3-3>).

2.2.3.3 VMEM Bulk Dump

This message sets the VMEM block (see Tables <4-1> and <4-2>).

2.2.3.4 AMEM Bulk Dump

This message sets the AMEM block (see Tables <4-1> and <4-3>).

3. Realtime Messages

3.1 Active Sensing

a) Send

This is not transmitted.

b) Receive

After FE is received one time, if the MIDI signal does not come within 400 msec, PLG150-DX will act the same as when ALL SOUND OFF, ALL NOTE OFF, and RESET ALL CONTROLLERS are received, and return to the condition where has not been received once.

<1-1>

Parameter Base Address

MODEL ID = 4C

Parameter	Address			Description
	(H)	(M)	(L)	
XG SYSTEM	00	00	00	System
	00	00	7E	XG System On
	00	00	7F	All Parameter Reset
MULTI PART	08	00	00	Multi Part 1
	:	:	:	:
	08	0F	00	Multi Part 16
MULTI PART (additional)	0A	00	00	Multi Part 1
	:	:	:	:
	0A	0F	00	Multi Part 16
PART ASSIGN	70	02	00	PLG150-DX Part Assign

<1-2>

MIDI Parameter Change table (XG SYSTEM)

Address (H)	Size (H)	Data (H)	Parameter	Description	Default Value (H)
0 0 0	4	00 - 0F	MASTER TUNE	-102.4...0...+102.3[cent]	00 04 00 00
		00 - 0F		1st bit3-0→bit15-12	
		00 - 0F		2nd bit3-0→bit11-8	
		00 - 0F		3rd bit3-0→bit7-4	
		00 - 0F		4th bit3-0→bit3-0	
4	1	00 - 7F	MASTER VOLUME**	0...127	7F
5	1	00 - 7F	MASTER ATTENUATOR**	0...127	0
6	1	28 - 58	TRANSPOSE	-24...0...+24[semitones]	40
7D	1		NOT USED		
7E	1	0	XG SYSTEM ON	00=XG system ON (receive only)	—
7F	1	0	ALL PARAMETER RESET	00=ON (receive only)	—
TOTAL SIZE	7				

** Processed on the XG platform side (MU128, etc.)

<1-3>

MIDI Parameter Change table (MULTI PART)

Address (H)	Size (H)	Data (H)	Parameter	Description	Default Value (H)
8 nn 0	1		NOT USED		
nn 1	1	00 - 7F	BANK SELECT MSB	0...127	0
nn 2	1	00 - 7F	BANK SELECT LSB	0...127	0
nn 3	1	00 - 7F	PROGRAM NUMBER	1...128	0
nn 4	1	00-1F,7F	Rev CHANNEL	A1...A16, OFF	Part No.
nn 5	1	00 - 01	MONO/POLY MODE	MONO, POLY	1
nn 6	1	00 - 02	SAME NOTE NUMBER	SINGLE, MULTI,...	1
					KEY ON ASSIGN
nn 7	1	00 - 05	PART MODE	NORMAL,...	0
nn 8	1	28 - 58	NOTE SHIFT	-24...0...+24[semitones]	40
nn 9	2	00 - 0F	DETUNE	-12.8...0...+12.7[Hz]	08 00
nn 0A		00 - 0F		1st bit3-0→bit7-4	
				2nd bit3-0→bit3-0	
nn 0B	1	00 - 7F	VOLUME**	0...127	64
nn 0C	1	00 - 7F	VELOCITY SENSE DEPTH	0...127	40
nn 0D	1	00 - 7F	VELOCITY SENSE OFFSET	0...127	40
nn 0E	1	00 - 7F	PAN**	C, L63...C...R63	40
nn 0F	1	00 - 7F	NOTE LIMIT LOW	C-2...G8	0
nn 10	1	00 - 7F	NOTE LIMIT HIGH	C-2...G8	7F
nn 11	1	00 - 7F	DRY LEVEL**	0...127	7F
nn 12	1	00 - 7F	CHORUS SEND**	0...127	0
nn 13	1	00 - 7F	REVERB SEND**	0...127	28
nn 14	1	00 - 7F	VARIATION SEND**	0...127	0
nn 15	1	00 - 7F	VIBRATO RATE	-64...0...+63	40
nn 16	1	00 - 7F	VIBRATO DEPTH	-64...0...+63	40
nn 17	1	00 - 7F	VIBRATO DELAY	-64...0...+63	40
nn 18	1	00 - 7F	LOW PASS FILTER CUTOFF FREQUENCY	-64...0...+63	40
nn 19	1	00 - 7F	LOW PASS FILTER RESONANCE	-64...0...+63	40
nn 1A	1	00 - 7F	EG ATTACK TIME	-64...0...+63	40
nn 1B	1	00 - 7F	EG DECAY TIME	-64...0...+63	40
nn 1C	1	00 - 7F	EG RELEASE TIME	-64...0...+63	40
nn 1D	1	28 - 58	MW PITCH CONTROL	-24...0...+24[semitones]	40
nn 1E	1	00 - 7F	MW LOW PASS FILTER CONTROL	-9600...0...+9450[cent]	40
nn 1F	1	00 - 7F	MW AMPLITUDE CONTROL**	-100...0...+100[%]	40
nn 20	1	00 - 7F	MW LFO PMOD DEPTH	0...127	0A
nn 21	1		NOT USED		—
nn 22	1	00 - 7F	MW LFO AMOD DEPTH	0...127	0
nn 23	1	28 - 58	BEND PITCH CONTROL	-24...0...+24[semitones]	42
nn 24	1	00 - 7F	BEND LOW PASS FILTER CONTROL	-9600...0...+9450[cent]	40
nn 25	1	00 - 7F	BEND AMPLITUDE CONTROL**	-100...0...+100[%]	40
nn 26	1	00 - 7F	BEND LFO PMOD DEPTH	0...127	0
nn 27	1		NOT USED		—
nn 28	1	00 - 7F	BEND LFO AMOD DEPTH	0...127	0
TOTAL SIZE	29				

MIDI Data Format

nn 30	1	00 - 01	Rev PITCH BEND	OFF, ON	1
nn 31	1	00 - 01	Rev CH AFTER TOUCH(CAT)	OFF, ON	1
nn 32	1	00 - 01	Rev PROGRAM CHANGE	OFF, ON	1
nn 33	1	00 - 01	Rev CONTROL CHANGE	OFF, ON	1
nn 34	1	00 - 01	Rev POLY AFTER TOUCH(PAT)	OFF, ON	1
nn 35	1	00 - 01	Rev NOTE MESSAGE	OFF, ON	1
nn 36	1	00 - 01	Rev RPN	OFF, ON	1
nn 37	1	00 - 01	Rev NRPN	OFF, ON	XGmode=01, GMmode=00
nn 38	1	00 - 01	Rev MODULATION	OFF, ON	1
nn 39	1	00 - 01	Rev VOLUME	OFF, ON	1
nn 3A	1	00 - 01	Rev PAN	OFF, ON	1
nn 3B	1	00 - 01	Rev EXPRESSION	OFF, ON	1
nn 3C	1	00 - 01	Rev HOLD1	OFF, ON	1
nn 3D	1	00 - 01	Rev PORTAMENTO	OFF, ON	1
nn 3E	1	00 - 01	Rev SOSTENUTO	OFF, ON	1
nn 3F	1		NOT USED		—
nn 40	1	00 - 01	Rev BANK SELECT	OFF, ON	XGmode=01, GMmode=00
nn 41	1	00 - 7F	SCALE TUNING C	-64...0...+63[cent]	40
nn 42	1	00 - 7F	SCALE TUNING C#	-64...0...+63[cent]	40
nn 43	1	00 - 7F	SCALE TUNING D	-64...0...+63[cent]	40
nn 44	1	00 - 7F	SCALE TUNING D#	-64...0...+63[cent]	40
nn 45	1	00 - 7F	SCALE TUNING E	-64...0...+63[cent]	40
nn 46	1	00 - 7F	SCALE TUNING F	-64...0...+63[cent]	40
nn 47	1	00 - 7F	SCALE TUNING F#	-64...0...+63[cent]	40
nn 48	1	00 - 7F	SCALE TUNING G	-64...0...+63[cent]	40
nn 49	1	00 - 7F	SCALE TUNING G#	-64...0...+63[cent]	40
nn 4A	1	00 - 7F	SCALE TUNING A	-64...0...+63[cent]	40
nn 4B	1	00 - 7F	SCALE TUNING A#	-64...0...+63[cent]	40
nn 4C	1	00 - 7F	SCALE TUNING B	-64...0...+63[cent]	40
nn 4D	1	28 - 58	CAT PITCH CONTROL	-24...0...+24[semitones]	40
nn 4E	1	00 - 7F	CAT LOW PASS FILTER CONTROL	-9600...0...+9450[cent]	40
nn 4F	1	00 - 7F	CAT AMPLITUDE CONTROL**	-100...0...+100[%]	40
nn 50	1	00 - 7F	CAT LFO PMOD DEPTH	0...127	0
nn 51	1		NOT USED		—
nn 52	1	00 - 7F	CAT LFO AMOD DEPTH	0...127	0
nn 53	1	28 - 58	PAT PITCH CONTROL	-24...0...+24[semitones]	40
nn 54	1		NOT USED		—
nn 55	1	00 - 7F	PAT AMPLITUDE CONTROL**	-100...0...+100[%]	40
nn 56	1	00 - 7F	PAT LFO PMOD DEPTH	0...127	0
nn 57	1		NOT USED		—
nn 58	1	00 - 7F	PAT LFO AMOD DEPTH	0...127	0
nn 59	1	00 - 5F	AC1 CONTROLLER NUMBER	0...95	10
nn 5A	1	28 - 58	AC1 PITCH CONTROL	-24...0...+24[semitones]	40
nn 5B	1	00 - 7F	AC1 LOW PASS FILTER CONTROL	-9600...0...+9450[cent]	40
nn 5C	1	00 - 7F	AC1 AMPLITUDE CONTROL**	-100...0...+100[%]	40
nn 5D	1	00 - 7F	AC1 LFO PMOD DEPTH	0...127	0
nn 5E	1		NOT USED		—
nn 5F	1	00 - 7F	AC1 LFO AMOD DEPTH	0...127	0
nn 60	1	00 - 5F	AC2 CONTROLLER NUMBER	0...95	11
nn 61	1	28 - 58	AC2 PITCH CONTROL	-24...0...+24[semitones]	40
nn 62	1	00 - 7F	AC2 LOW PASS FILTER CONTROL	-9600...0...+9450[cent]	40
nn 63	1	00 - 7F	AC2 AMPLITUDE CONTROL**	-100...0...+100[%]	40
nn 64	1	00 - 7F	AC2 LFO PMOD DEPTH	0...127	0
nn 65	1		NOT USED		—
nn 66	1	00 - 7F	AC2 LFO AMOD DEPTH	0...127	0
nn 67	1	00 - 01	PORTAMENTO SWITCH	OFF, ON	0
nn 68	1	00 - 7F	PORTAMENTO TIME	0...127	0
nn 69	1	00 - 7F	PITCH EG INITIAL LEVEL	-64...0...+63	40
nn 6A	1	00 - 7F	PITCH EG ATTACK TIME	-64...0...+63	40
nn 6B	1	00 - 7F	PITCH EG RELEASE LEVEL	-64...0...+63	40
nn 6C	1	00 - 7F	PITCH EG RELEASE TIME	-64...0...+63	40
nn 6D	1	01 - 7F	VELOCITY LIMIT LOW	1...127	1
nn 6E	1	01 - 7F	VELOCITY LIMIT HIGH	1...127	7F
TOTAL SIZE 3F					
nn 70	1		NOT USED		—
nn 71	1		NOT USED		—
nn 72	1	00 - 7F	EQ BASS GAIN	-12 - +12[dB]	40
nn 73	1	00 - 7F	EQ TREBLE GAIN	-12 - +12[dB]	40
TOTAL SIZE 4					
nn 74	1		NOT USED		—
nn 75	1		NOT USED		—
nn 76	1	04 - 28	EQ BASS FREQUENCY	32...2.0k[Hz]	0C
nn 77	1	1C - 3A	EQ TREBLE FREQUENCY	500...16.0k[Hz]	36
nn 78	1		NOT USED		—
nn 79	1		NOT USED		—
nn 7A	1		NOT USED		—
nn 7B	1		NOT USED		—
nn 7C	1		NOT USED		—
nn 7D	1		NOT USED		—
nn 7E	1		NOT USED		—
nn 7F	1		NOT USED		—
TOTAL SIZE 0C					
0A nn 20	1	00 - 7F	HIGH PASS FILTER CUTOFF FREQUENCY	-64...0...+63	40
nn 21	1		NOT USED		—
TOTAL SIZE 2					

nn = PART NUMBER

** Processed on the XG platform side (MU128/100, etc.)

<1-4>

MIDI Parameter Change table (PART ASSIGN)

Address (H)	Size (H)	Data (H)	Parameter	Description	Default Value (H)
70 2	nn	1	00 - 0F,7F	Part Assign	A1...A16, OFF
TOTAL SIZE		1			0

nn = PLG150-DX Serial Number

<2-1>

Parameter Bass Address

MODEL ID = 62

Parameter	Address			Description
	(H)	(M)	(L)	
PLG150-DX SYSTEM	00	00	00	System
PLG150-DX MULTI PART	60	00	00	Multi Part 1
	:	:	:	:
	60	0F	00	Multi Part 16

<2-2>

MIDI Parameter Change table (PLG150-DX Native SYSTEM)

Address (H)	Size (H)	Data (H)	Parameter	Description	Default Value (H)
0 0	7	1		NOT USED	—
	8	1	00 - 06	VELOCITY CURVE	DX,normal,Soft1,Soft2,Easy,Wide,Hard
	9	1		NOT USED	—
	0A	1		NOT USED	—
	0B	1		NOT USED	—
	0C	1		NOT USED	—
	0D	1		NOT USED	—
	0E	1	00 - 01	32 BULK RECEIVE BLOCK	1-32, 33-64
	0F	1		NOT USED	—
TOTAL SIZE		9			

<2-3>

MIDI Parameter Change table (PLG150-DX Native MULTI PART)

Address (H)	Size (H)	Data (H)	Parameter	Description	Default Value (H)
60 nn	0	1	00 - 06	AC4 Controller	Off, MOD, BC, FC, EXP, CAT, PB
	1	1	00 - 01	AC4 Parameter Select	Noassign, EGBias
	2	1		NOT USED	0
	3	1		NOT USED	0
	4	1		NOT USED	0
	5	1	00 - 7F	AC4 Parameter Depth	-64...0...+63
	6	1		NOT USED	40
	7	1		NOT USED	40
	8	1		NOT USED	40
	9	1		NOT USED	0
	0A	1		NOT USED	0
	0B	1	00 - 7F	Carrier Level1	-64...0...+63
	0C	1	00 - 7F	Carrier Level2	-64...0...+63
	0D	1	00 - 7F	Carrier Level3	-64...0...+63
	0E	1	00 - 7F	Carrier Level4	-64...0...+63
	0F	1	00 - 7F	Carrier Level5	-64...0...+63
	10	1	00 - 7F	Carrier Level6	-64...0...+63
	11	1		NOT USED	40
	12	1		NOT USED	40
	13	1	00 - 7F	Modulator Level1	-64...0...+63
	14	1	00 - 7F	Modulator Level2	-64...0...+63
	15	1	00 - 7F	Modulator Level3	-64...0...+63
	16	1	00 - 7F	Modulator Level4	-64...0...+63
	17	1	00 - 7F	Modulator Level5	-64...0...+63
	18	1	00 - 7F	Modulator Level6	-64...0...+63
	19	1		NOT USED	40
	1A	1		NOT USED	40
	1B	1	39 - 47	FeedBack Level	-7...0...+7
TOTAL SIZE		1C			
60 nn	1C	1	00 - 01	Portamento Mode	0:retain(poly),fingered(mono), 1:follow(mono),fulltime(poly)
	1D	1	00 - 0C	Portamento Step	0...12
	1E	1	00 - 0C	PitchBend Step	0...12
	1F	1		NOT USED	0
TOTAL SIZE		4			
nn	20	1	00 - 01	RevDxSysEx	0:OFF 1:ON
nn = PART NUMBER					

MIDI Data Format

<3-1>

Parameter Group Number

Group No.		Description	parameter#
g	h		
00	00	VCED (Voice Edit Buffer)	0...127
00	01	VCED (Voice Edit Buffer)	0...28
06	00	ACED (Additional Edit Buffer)	0...73

<3-2>

MIDI Parameter Change table (DX Voice Parameter - VCED format)

Parameter Group#		Parameter#							Size	Data	Parameter	Description	Default Value
g	h	OP6	OP5	OP4	OP3	OP2	OP1					(H)	
(H)	(H)	(H)	(H)	(H)	(H)	(H)	(H)	(H)	(H)				
00	00	00	15	2A	3F	54	69	1	00 - 63	EG RATE1	0...99	63	
	00	01	16	2B	40	55	6A	1	00 - 63	EG RATE2	0...99	63	
	00	02	17	2C	41	56	6B	1	00 - 63	EG RATE3	0...99	63	
	00	03	18	2D	42	57	6C	1	00 - 63	EG RATE4	0...99	63	
	00	04	19	2E	43	58	6D	1	00 - 63	EG LEVEL1	0...99	63	
	00	05	1A	2F	44	59	6E	1	00 - 63	EG LEVEL2	0...99	63	
	00	06	1B	30	45	5A	6F	1	00 - 63	EG LEVEL3	0...99	63	
	00	07	1C	31	46	5B	70	1	00 - 63	EG LEVEL4	0...99	00	
	00	08	1D	32	47	5C	71	1	00 - 63	BREAK POINT	A-1...C8	27	
	00	09	1E	33	48	5D	72	1	00 - 63	LEFT DEPTH	0...99	00	
	00	0A	1F	34	49	5E	73	1	00 - 63	RIGHT DEPTH	0...99	00	
	00	0B	20	35	4A	5F	74	1	00 - 03	LEFT CURVE	-lin,-exp,+exp,+lin	00	
	00	0C	21	36	4B	60	75	1	00 - 03	RIGHT CURVE	-lin,-exp,+exp,+lin	00	
	00	0D	22	37	4C	61	76	1	00 - 07	RATE SCALING	0...7	00	
	00	0E	23	38	4D	62	77	1	00 - 03	AMPLITUDE MODULATION SENSITIVITY	0...3	00	
	00	0F	24	39	4E	63	78	1	00 - 07	TOUCH SENSITIVITY	0...7	00	
	00	10	25	3A	4F	64	79	1	00 - 63	TOTAL LEVEL	0...99	OP1=99,otherOP=0	
	00	11	26	3B	50	65	7A	1	00 - 01	FREQUENCY MODE	ratio,fixed	00	
	00	12	27	3C	51	66	7B	1	00 - 1F	FREQUENCY COURSE	0...31	01	
	00	13	28	3D	52	67	7C	1	00 - 63	FREQUENCY FINE	0...99	00	
	00	14	29	3E	53	68	7D	1	00 - 0E	DETUNE	-7...0...+7	07	
	00						7E	1	00 - 63	PEG RATE1	0...99	63	
	00						7F	1	00 - 63	PEG RATE2	0...99	63	
	01						00	1	00 - 63	PEG RATE3	0...99	63	
	01						01	1	00 - 63	PEG RATE4	0...99	63	
	01						02	1	00 - 63	PEG LEVEL1	0...99	32	
	01						03	1	00 - 63	PEG LEVEL2	0...99	32	
	01						04	1	00 - 63	PEG LEVEL3	0...99	32	
	01						05	1	00 - 63	PEG LEVEL4	0...99	32	
	01						06	1	00 - !F	ALGORITHM SELECTOR	1...32	00	
	01						07	1	00 - 07	FEEDBACK LEVEL	0...7	00	
	01						08	1	00 - 01	OSC PHASE INIT	off,on	01	
	01						09	1	00 - 63	LFO SPEED	0...99	23	
	01						0A	1	00 - 63	LFO DELAY TIME	0...99	00	
	01						0B	1	00 - 63	PITCH MODULATION DEPTH	0...99	00	
	01						0C	1	00 - 63	AMPLITUDE MODULATION DEPTH	0...99	00	
	01						0D	1	00 - 01	LFO KEY SYNC	off,on	01	
	01						0E	1	00 - 05	LFO WAVE	triangle,sawdown, sawup,square, sine,s/hold	00	
	01						0F	1	00 - 07	LFO PITCH MODULATION SENSITIVITY	0...7	03	
	01						10	1	00 - 2F	TRANSPOSE	C1...C5	18	
	01						11	1	25 - 58	VOICE NAME	32...127 (ASCII CHARACTER)	'I'	
	01						12	1	25 - 58	VOICE NAME	32...127 (ASCII CHARACTER)	'N'	
	01						13	1	25 - 58	VOICE NAME	32...127 (ASCII CHARACTER)	'I'	
	01						14	1	25 - 58	VOICE NAME	32...127 (ASCII CHARACTER)	'T'	
	01						15	1	25 - 58	VOICE NAME	32...127 (ASCII CHARACTER)	'V'	
	01						16	1	25 - 58	VOICE NAME	32...127 (ASCII CHARACTER)	'O'	
	01						17	1	25 - 58	VOICE NAME	32...127 (ASCII CHARACTER)	'I'	
	01						18	1	25 - 58	VOICE NAME	32...127 (ASCII CHARACTER)	'C'	
	01						19	1	25 - 58	VOICE NAME	32...127 (ASCII CHARACTER)	'E'	
	01						1A	1	25 - 58	VOICE NAME	32...127 (ASCII CHARACTER)	'E'	
							TOTAL SIZE	9B					
	01						1B	1	00 - 3F	OPERATOR ENABLE	Bit5:OP1,Bit4:OP2,Bit3:OP3, Bit2:OP4,Bit1:OP5,Bit0:OP6	off,on	

<3-3>

IDI Parameter Change table (DX Voice Additional Parameter - ACED format)

Parameter Group#		Parameter#	Size	Data	Parameter	Description	Default Value
g	h						(H)
(H)	(H)	(H)	(H)	(H)			
06	00	00	1			NOT USED	—
		01	1			NOT USED	—
		02	1			NOT USED	—
		03	1			NOT USED	—
		04	1			NOT USED	—
		05	1			NOT USED	—
		06	1	00 - 07	OP6	AMPLITUDE MODULATION SENSITIVITY	0...7

07	1	00 - 07	OP5 AMPLITUDE MODULATION SENSITIVITY	0...7	00
08	1	00 - 07	OP4 AMPLITUDE MODULATION SENSITIVITY	0...7	00
09	1	00 - 07	OP3 AMPLITUDE MODULATION SENSITIVITY	0...7	00
0A	1	00 - 07	OP2 AMPLITUDE MODULATION SENSITIVITY	0...7	00
0B	1	00 - 07	OP1 AMPLITUDE MODULATION SENSITIVITY	0...7	00
0C	1	00 - 03	PITCH EG RANGE	8va,2va,1va,1/2va	00
0D	1	00 - 01	LFO KEY TRIGGER	single,multi	00
0E	1	00 - 01	PITCH EG BY VELOCITY SWITCH	off,on	00
0F	1	00 - 03	POLY/MONO,UNISON SWITCH	bit0:poly/mono,bit1:unison off/on	00
10	1	00 - 0C	PITCH BEND RANGE	0...12	02
11	1	00 - 0C	PITCH BEND STEP	0...12	00
12	1		NOT USED	---	---
13	1	00 - 07	RANDOM PITCH FLUCTUATION	0...7	00
14	1	00 - 01	PORTAMENTO MODE	rtn/flw, fingrd/fltm	00
15	1	00 - 0C	PORTAMENTO STEP	0...12	00
16	1	00 - 63	PORTAMENTO TIME	0...99	00
17	1		NOT USED	---	---
18	1		NOT USED	---	---
19	1		NOT USED	---	---
1A	1		NOT USED	---	---
1B	1		NOT USED	---	---
1C	1		NOT USED	---	---
1D	1		NOT USED	---	---
1E	1		NOT USED	---	---
1F	1		NOT USED	---	---
20	1		NOT USED	---	---
21	1		NOT USED	---	---
22	1		NOT USED	---	---
23	1		NOT USED	---	---
24	1		NOT USED	---	---
25	1		NOT USED	---	---
26	1	00 - 07	PITCH EG RATE SCALING DEPTH	0...7	---
40	1		NOT USED	---	---
41	1		NOT USED	---	---
42	1		NOT USED	---	---
43	1		NOT USED	---	---
44	1		NOT USED	---	---
45	1		NOT USED	---	---
46	1		NOT USED	---	---
47	1		NOT USED	---	---
48	1	00 - 07	UNISON DETUNE DEPTH	0...7	00
49	1		NOT USED	---	---
TOTAL SIZE	31				

<4-1>

Parameter Group Number

Format No.	Description	Total Size
00	VCED (Voice Edit Buffer)	155
05	ACED (Additional Edit Buffer)	49
06	AMEM (packed 32 supplement)	1120
09	VMEM (packed 32 voice)	4096

<4-2>

DX Packed Voice Parameter - VMEM format

Parameter#	Size	Parameter
OP6 (H)	(H)	EG RATE1
OP5 (H)	(H)	EG RATE2
OP4 (H)	(H)	EG RATE3
OP3 (H)	(H)	EG RATE4
OP2 (H)	(H)	EG LEVEL1
OP1 (H)	(H)	EG LEVEL2
01	1	EG LEVEL3
02	1	EG LEVEL4
03	1	BREAK POINT
04	1	LEFT DEPTH
05	1	RIGHT DEPTH
06	1	RIGHT CURVE/LEFT CURVE
07	1	DETUNE/RATE SCALING
08	1	TOUCH SENSITIVITY/AMPLITUDE MODULATION SENSITIVITY
09	1	TOTAL LEVEL
0A	1	FREQUENCY COURSE/FREQUENCY MODE
0B	1	FREQUENCY FINE
66	1	PEG RATE1
67	1	PEG RATE2
68	1	PEG RATE3
69	1	PEG RATE4
6A	1	PEG LEVEL1
6B	1	PEG LEVEL2
6C	1	PEG LEVEL3
6D	1	PEG LEVEL4

Description

BIT6	BIT5	BIT4	BIT3	BIT2	BIT1	BIT0
R1						
R2						
R3						
R4						
L1						
L2						
L3						
L4						
BP						
LD						
RD						
---			RC	LC		
---			PD	RS		
---			TS	AMS		
---			TL	---		
---			PC	PM		
PF						
PR1						
PR2						
PR3						
PR4						
PL1						
PL2						
PL3						
PL4						

When Your PLG150-DX Seems to Have a Problem

Please check the items below when your PLG150-DX isn't generating sounds or when it isn't functioning normally. Also, when the current status of the settings for your PLG150-DX isn't clear, it's a good idea to turn the power off, then on again (returning the settings to their defaults), and try entering your settings again.

The PLG150-DX doesn't produce sounds

- Are the MU128 and the playback equipment (such as speakers or headphones) correctly connected?
- Is the PLG150-DX board properly mounted in the XG plug-in connector? Take a look at the pages in your XG tone generator manual that explain how to install the board.
- Are the volume and expression for the part selected for the PLG150-DX voice raised to the proper level? the carrier output level set at -64? (page 29)
- This may happen when voices are placed in the user bank and edited with the DX Simulator. Check the settings.

In Multipart Edit, the "PLUGIN" menu doesn't appear.

- Is the PLG150-DX correctly installed?

The pitch is not right

- Has note shift or transpose information been set?
- This may happen when voices are placed in the user bank and edited with the DX simulator. Check the settings.

Notes won't stop playing

- Because EG Release Level (L4) is set for the voices below, they won't stop playing, even when a Note Off is received (The same applies to the User voice).

MSB	LSB	Program Ch.	Voice Name
83	0	52	DX Grw12
83	0	82	DX-Train
83	0	91	MobyDick
83	0	123	ManEater



If you switch voices, the sound will stop.

The vibrato is different for each voice

- This happens because an appropriate LFO Mode is set for each voice. When a chord is played with some voices, vibrato is applied individually to match the dynamics for the way each key was played. For other voices, the same vibrato that was applied for the dynamics of the first key played will be applied to all notes.

Notes sound different for each Note ON

- Because an appropriate oscillator sync is set for each voice, phase shift occurs between the operators. Depending on the voice, the sound may be slightly different each time a key is played.

Wenn Probleme mit der PLG150-DX auftreten

Überprüfen Sie bitte folgendes, wenn die PLG150-DX keinen Sound erzeugt oder nicht ordnungsgemäß funktioniert. Auch wenn der aktuelle Status der Einstellungen für die PLG150-DX nicht eindeutig ist, sollten Sie das Gerät ausschalten, wieder einschalten (so kehren Sie zu den Standardeinstellungen zurück), und jetzt erneut versuchen, Ihre Einstellungen vorzunehmen.

Die PLG150-DX erzeugt keinen Sound

- Ist das MU128 und die Wiedergabegeräte (wie z. B. Lautsprecher oder Kopfhörer) korrekt angeschlossen?
- Ist die PLG150-DX-Karte korrekt in den XG-Plug-in-Anschluß eingesetzt? Lesen Sie bitte im Handbuch des XG-Klangerzeugers nach, wie die Karte installiert wird.
- Sind die Lautstärke und der Ausdruck für den Part, der für die PLG150-DX-Stimme gewählt wurde, auf den entsprechenden Pegel eingestellt? Ist der Trägerausgabepiegel auf -64 eingestellt? (Seite 29)
- Das kann der Fall sein, wenn Voices (Stimmen) in benutzerdefinierte Banken plaziert und mit dem DX-Simulator bearbeitet werden. Überprüfen Sie die Einstellungen.

In Multipart Edit (Multipartbearbeitung) wir das Menü "PLUGIN" nicht angezeigt.

- Ist die PLG150-DX korrekt installiert?

Die Tonhöhe stimmt nicht

- Wurden Informationen für Notenwechsel oder dem Ändern der Tonhöhe eingestellt?
- Das kann der Fall sein, wenn Voices (Stimmen) in benutzerdefinierte Banken plaziert und mit dem DX-Simulator bearbeitet werden. Überprüfen Sie die Einstellungen.

Noten werden endlos gespielt

- Da der EG-Release-Pegel (L4) für die darunterliegenden Voices (Stimmen) eingestellt ist, wird die Wiedergabe nicht beendet, selbst wenn der Befehl Note-Off empfangen wird (Das gleiche gilt für die Benutzerstimme).

MSB	LSB	Programmkanal	Voice Name (Stimmename)
83	0	52	DX Grw12
83	0	82	DX-Train
83	0	91	MobyDick
83	0	123	ManEater



Wenn Sie die Voice (Stimme) wechseln, stoppt der Sound.

Das Vibrato ist für jede Voice (Stimme) anders

- Das ist der Fall, weil für jede Stimme ein entsprechender LFO-Modus festgelegt wurde. Wenn ein Akkord mit verschiedenen Voices (Stimmen) gespielt wird, wird das Vibrato individuell angewendet, so daß es mit der Dynamik übereinstimmt, mit der jede Taste gespielt wurde. Bei anderen Voices (Stimmen) wird das gleiche Vibrato, das auf die Dynamik der ersten gespielten Taste angewendet wurde auf alle Noten angewendet.

Noten klingen bei jedem Note-ON anders

- Da für jede Voice (Stimme) eine Oszillatorsynchronisation festgelegt wurde, wird zwischen den Operatoren eine Phasenverschiebung ausgeführt. Abhängig von der Voice (Stimme), kann der Sound bei jedem Spielen der Taste ein wenig anders klingen.

Lorsque votre PLG150-DX semble avoir un problème

Vérifiez les éléments ci-dessous lorsque votre PLG150-DX ne génère aucun son ou ne fonctionne pas normalement. De plus, si vous n'êtes pas sûr de l'état actuel des réglages de votre PLG150-DX, nous vous recommandons d'éteindre puis de rallumer (ce qui rétablit les valeurs par défaut), et d'essayer de rentrer à nouveau vos réglages.

La carte PLG150-DX ne produit aucun son.

- L'appareil MU128 et le matériel de reproduction (par exemple, les écouteurs ou haut-parleurs) sont-ils correctement connectés ?
- La carte PLG150-DX est-elle montée correctement dans le connecteur plug-in XG ? Reportez-vous aux pages de votre mode d'emploi du générateur de son XG qui expliquent comment installer la carte.
- Le volume et l'expression pour la partie sélectionnée pour le son PLG150-DX sont-ils réglés au bon niveau ? le niveau de sortie est-il réglé à -64 ? (voir page 29).
- Cela peut arriver lorsque les sons sont placés dans la banque personnalisée et édités avec DX Simulator. Vérifiez les réglages.

Dans Multipart Edit (Édition multi-parties), le menu "PLUGIN" n'apparaît pas.

- La carte PLG150-DX est-elle correctement installée ?

La hauteur n'est pas bonne.

- Des informations de transposition ou de décalage de notes ont-elles été définies ?
- Cela peut arriver lorsque les sons sont placés dans la banque personnalisée et édités avec DX Simulator. Vérifiez les réglages.

Les notes ne cessent d'être reproduites

- Puisque EG Release Level (Niveau de relâchement de GE) (L4) est défini pour les sons ci-dessous, ils ne cesseront pas d'être joués même si Note Off (Désactivation de note) est reçue (cela s'applique aussi au son Utilisateur).

MSB	LSB	Canal progr.	Nom de son
83	0	52	DX Grw12
83	0	82	DX-Train
83	0	91	MobyDick
83	0	123	ManEater



Si vous changez les sons, ils ne seront plus joués.

Le vibrato varie selon les sons

- Cela se produit lorsqu'un Mode LFO (Mode OBF) approprié est défini pour chaque son. Lorsqu'un accord est joué avec certains sons, le vibrato appliqué à chaque note est différent selon la dynamique avec laquelle la note a été jouée. Pour les autres sons, le vibrato appliqué pour la dynamique de la première note jouée sera appliqué également à toutes les autres notes.

Les notes ont un son différent pour chaque Note ON (Activation de note)

- Comme une synchronisation d'oscillateur appropriée est définie pour chaque son, un changement de phase se produit entre les opérateurs. En fonction du son, le résultat peut être légèrement différent chaque fois qu'une note est jouée.

MIDI Implementation Chart

YAMAHA [Advanced DX/TX Plug-in Board] Date:07-OCT-1999
 Model PLG150-DX MIDI Implementation Chart Version : 1.0

Function...	Transmitted	Recognized	Remarks
Basic Channel	x x	1 1 - 16	
Mode	x x *****	3 3, 4 (m=1) x	*2
Note Number : True voice	x *****	0 - 127 0 - 127	
Velocity Note ON Note OFF	x x	o 9nH, v=1-127 x	
After Touch Key's Ch's	x x	o o	*1 *1
Pitch Bend	x	o 0-24 semi	*1
Control Change	x x x x x x x x x	o o o o o o o o o	*1 *1 *1 *1 *1 *1 *1 *1 *1
			Bank Select Data Entry Sound Controller RPN Inc,Dec NRPN LSB,MSB RPN LSB,MSB

Prog Change : True #	x *****	o 0 - 127	
System Exclusive	o *3	o *3	
Common : Song Pos. : Song Sel. : Tune	x x x	x x x	
System : Clock Real Time: Commands	x x	x x	
Aux : All Sound Off : Reset All Cntrls : Local ON/OFF : All Notes OFF Mes- : Active Sense sages: Reset	x x x x x x	o(120,126,127) o(121) x o(123-125) o x	
Notes:	*1 receive if switch is on. *2 m is always treated as "1" regardless of its value. *3 transmit/receive if exclusive switch is on.		

Mode 1 : OMNI ON , POLY Mode 2 : OMNI ON , MONO o : Yes
 Mode 3 : OMNI OFF, POLY Mode 4 : OMNI OFF, MONO x : No

SOFTWARE LICENSING AGREEMENT

The following is a legal agreement between you, the end user, and Yamaha Corporation (“Yamaha”). The enclosed Yamaha software program is licensed by Yamaha to the original purchaser for use only on the terms set forth herein. Please read this licensing agreement with care. Opening this package indicates that you accept all terms outlined herein. If you do not agree to the terms, return this package unopened to Yamaha for a full refund.

1. GRANT OF LICENSE AND COPYRIGHT

Yamaha grants you, the original purchaser, the right to use one copy of the enclosed software program and data (“SOFTWARE”) on a single-user computer system. You may not use it on more than one computer or computer terminal. The SOFTWARE is owned by Yamaha and is protected by Japanese copyright laws and all applicable international treaty provisions. You are entitled to claim ownership of the media in which the SOFTWARE is included. Therefore, you must treat the SOFTWARE like any other copyrighted materials.

2. RESTRICTIONS

The SOFTWARE program is copyrighted. You may not engage in reverse engineering or reproduction of the SOFTWARE by other conceivable methods. You may not reproduce, modify, change, rent, lease, resell, or distribute the SOFTWARE in whole or in part, or create derivative works from the SOFTWARE. You may not transmit or network the SOFTWARE with other computers.

You may transfer ownership of the SOFTWARE and the accompanying written materials on a permanent basis provided that you retain no copies and the recipient agrees to the terms of the licensing agreement.

3. TERMINATION

The licensing condition of the software program becomes effective on the day that you receive the SOFTWARE. If any one of the copyright laws or clauses of the licensing conditions is violated, the licensing agreement shall be terminated automatically without notice from Yamaha. In this case, you must destroy the licensed SOFTWARE and its copies immediately.

4. PRODUCT WARRANTY

Yamaha warrants to the original purchaser that if the SOFTWARE, when used in normal conditions, will not perform the functions described in the manual provided by Yamaha, the sole remedy will be that Yamaha will replace any media which proves defective in materials or workmanship on an exchange basis without charge. Except as expressly set forth above, the SOFTWARE is provided “as is,” and no other warranties, either expressed or implied, are made with respect to this software, including, without limitation the implied warranties of merchantability and fitness for a particular purpose.

5. LIMITED LIABILITY

Your sole remedies and Yamaha’s entire liability are as set forth above. In no event will Yamaha be liable to you or any other person for any damages, including without limitation any incidental or consequential damages, expenses, lost profits, lost savings or other damages arising out of the use or inability to use such SOFTWARE even if Yamaha or an authorized dealer has been advised of the possibility of such damages, or for any claim by any other party.

6. GENERAL

This license agreement shall be interpreted according to and governed by Japanese laws.

SOFTWARE-LIZENZVEREINBARUNG

Die folgende Vereinbarung ist eine rechtsgültige Vereinbarung zwischen Ihnen, dem Endanwender, und der Yamaha Corporation („Yamaha“). Yamaha erteilt dem ursprünglichen Käufer für das beiliegende Yamaha-Softwareprogramm ausschließlich zu den hier ausgeführten Bedingungen eine Lizenz zur Verwendung. Bitte lesen Sie diese Lizenzvereinbarung sorgfältig. Durch das Öffnen dieser Packung bringen Sie zum Ausdruck, daß Sie alle darin enthaltenen Bedingungen akzeptieren. Wenn Sie nicht mit den Bedingungen einverstanden sind, können Sie die Packung ungeöffnet an Yamaha zurückgeben; der Kaufpreis wird in voller Höhe zurückerstattet.

1. ERETLUNG VON LIZENZ UND COPYRIGHT

Yamaha erteilt Ihnen, dem ursprünglichen Käufer, das Recht, ein Exemplar des beiliegenden Softwareprogramms und der darin enthaltenen Daten („SOFTWARE“) als Einzelperson auf jeweils einem Computer zu verwenden. Sie dürfen sie nicht auf mehr als einem Computer bzw. einer Computerstation verwenden. Die SOFTWARE bleibt im Besitz von Yamaha und ist durch japanische Copyrightgesetze sowie alle anwendbaren internationalen Vertragsbestimmungen geschützt. Sie haben ein Anspruchsrecht auf das Eigentum an den Medien, denen die SOFTWARE beiliegt. Daher müssen Sie die SOFTWARE wie alle anderen durch Copyright geschützten Materialien behandeln.

2. EINSCHRÄNKUNGEN

Die SOFTWARE ist durch Copyright geschützt. Sie dürfen Sie weder analysieren noch durch anderweitige Methoden reproduzieren. Sie dürfen die SOFTWARE weder ganz noch teilweise reproduzieren, modifizieren, verändern, gegen Entgelt oder unentgeltlich verleihen, verkaufen oder vertreiben, und Sie dürfen auf der Grundlage der SOFTWARE keine Ableitungen erstellen. Sie dürfen die SOFTWARE nicht an andere Computer senden oder in Netzwerke einspeisen. Sie dürfen das Eigentum an der SOFTWARE und den schriftlichen Begleitmaterialien auf unbefristeter Basis unter den Voraussetzungen übertragen, daß Sie keine Kopien zurückbehalten und sich der Empfänger mit den Bedingungen der Lizenzvereinbarung einverstanden erklärt.

3. BEENDIGUNG

Die Lizenzbedingung des Softwareprogramms wird am Tag, an dem Sie die SOFTWARE erhalten, wirksam. Falls ein Copyrightgesetz oder eine Bestimmung der Lizenzbedingungen verletzt wird, wird automatisch und ohne Benachrichtigung durch Yamaha die Lizenzvereinbarung beendet. In diesem Fall müssen Sie die lizenzierte SOFTWARE und ihre Kopien unverzüglich vernichten.

4. PRODUKTGARANTIE

Yamaha garantiert dem ursprünglichen Käufer, daß, falls die SOFTWARE bei Verwendung unter normalen Bedingungen nicht die in der von Yamaha bereitgestellten Anleitung beschriebenen Funktionen erfüllt, die einzige Abhilfe darin bestehen wird, daß Yamaha auf Austauschbasis kostenlos jedes Medium ersetzen wird, das Material- oder Verarbeitungsfehler aufweist. Abgesehen von dem oben Ausgeführten wird die SOFTWARE „wie die Ware liegt und steht“ geliefert, und es werden keine anderen ausdrücklichen oder stillschweigenden Garantien hinsichtlich dieser Software übernommen, einschließlich, aber nicht beschränkt auf, die stillschweigenden Garantien für handelsübliche Qualität und Eignung für einen bestimmten Einsatzzweck.

5. BESCHRÄNKTE HAFTUNG

Ihre einzige Abhilfe und die gesamte Haftung Yamahas bestehen in dem oben Ausgeführten. Keinesfalls haftet Yamaha Ihnen oder einer anderen Person gegenüber für etwaige Schäden, einschließlich, aber nicht beschränkt auf, zufällige Schäden oder Folgeschäden, Kosten, Verdienstaufschlag, verlorene Ersparnisse oder andere Schadenersatzansprüche, die aus der Verwendung der SOFTWARE oder aus der Tatsache hervorgehen, daß diese SOFTWARE nicht verwendet werden konnte, selbst wenn Yamaha oder ein autorisierter Händler über die Möglichkeit derartiger Schadenersatzansprüche informiert wurde, oder für etwaige andere Ansprüche einer anderen Partei.

6. ALLGEMEINES

Diese Lizenzvereinbarung soll gemäß und in Übereinstimmung mit den japanischen Gesetzen ausgelegt werden.

CONTRAT DE LICENCE DE LOGICIEL

Ceci est un contrat entre vous-même, l'utilisateur final, et Yamaha Corporation ("Yamaha"). Le logiciel Yamaha ci-inclus est concédé sous licence par Yamaha à l'acheteur original et ne peut être utilisé que dans les conditions prévues aux présentes. Veuillez lire attentivement ce contrat de licence. Le fait d'ouvrir ce coffret indique que vous acceptez l'ensemble des termes du contrat. Si vous n'acceptez pas lesdits termes, renvoyez le coffret non ouvert à Yamaha pour en obtenir le remboursement intégral.

1. CONCESSION DE LICENCE ET DROITS D'AUTEUR

Yamaha vous concède le droit d'utiliser, en tant qu'acheteur original, un exemplaire du logiciel et des données afférentes à celui-ci ("LOGICIEL") sur un ordinateur pour utilisateur unique. Vous n'êtes pas autorisé à utiliser ces éléments sur plus d'un ordinateur ou terminal d'ordinateur. Le LOGICIEL est la propriété de Yamaha. Il est protégé par les dispositions relatives au droit d'auteur contenues dans la législation japonaise et les traités internationaux. Vous êtes en droit de revendiquer l'appartenance du support du LOGICIEL. A ce titre, vous devez traiter le LOGICIEL comme tout autre élément protégé par le droit d'auteur.

2. RESTRICTIONS

Le LOGICIEL est protégé par le droit d'auteur. Vous n'êtes pas autorisé à reconstituer la logique du LOGICIEL ou à reproduire ce dernier par quelque autre moyen que ce soit. Vous n'êtes pas en droit de reproduire, modifier, prêter, louer, revendre ou distribuer le LOGICIEL en tout ou partie, ou d'utiliser le LOGICIEL à des fins de création dérivée. Vous n'êtes pas autorisé à transmettre le LOGICIEL à d'autres ordinateurs ou à l'utiliser en réseau.

Vous êtes en droit de céder, à titre permanent, le LOGICIEL et la documentation imprimée qui l'accompagne, sous réserve que vous n'en conserviez aucun exemplaire et que le bénéficiaire accepte les termes du présent contrat.

3. RESILIATION

Les conditions énoncées dans le présent contrat de licence prennent effet à compter du jour où le LOGICIEL vous est remis. Si l'une quelconque des dispositions relatives au droit d'auteur ou des clauses du contrat ne sont pas respectées, le contrat de licence sera résilié de plein droit par Yamaha, ce sans préavis. Dans ce cas, vous devrez immédiatement détruire le LOGICIEL concédé sous licence ainsi que les copies réalisées.

4. GARANTIE PRODUIT

Si, dans des conditions normales d'utilisation, le LOGICIEL ne remplit pas les fonctions décrites dans le manuel fourni, Yamaha s'engage vis-à-vis de l'acheteur original à remplacer gratuitement, sur la base d'un échange, tout support reconnu défectueux par suite d'un défaut de matière première ou d'un vice de fabrication. Ceci constitue le seul recours opposable à Yamaha. Hormis dans les cas expressément énoncés plus haut, le LOGICIEL est livré "en l'état" et toute autre garantie expresse ou implicite le concernant, y compris, de manière non limitative, toute garantie implicite de qualité marchande et d'adéquation à un usage particulier, est exclue.

5. RESPONSABILITE LIMITEE

Votre unique recours et la seule responsabilité de Yamaha sont tels qu'énoncés précédemment. En aucun cas Yamaha ne pourra être tenu responsable, par vous-même ou une autre personne, de quelques dommages que ce soit, notamment et de manière non limitative, de dommages indirects, frais, pertes de bénéfices, pertes de fonds ou d'autres dommages résultant de l'utilisation ou de l'impossibilité d'utiliser le LOGICIEL, même si Yamaha ou un distributeur agréé ont été prévenus de l'éventualité de tels dommages, ou de quelque autre revendication formulée par une tierce partie.

6. REMARQUE GENERALE

Le présent contrat de licence est régi par le droit japonais, à la lumière duquel il doit être interprété.

For details of products, please contact your nearest Yamaha or the authorized distributor listed below.

Pour plus de détails sur les produits, veuillez-vous adresser à Yamaha ou au distributeur le plus proche de vous figurant dans la liste suivante.

Die Einzelheiten zu Produkten sind bei Ihrer unten aufgeführten Niederlassung und bei Yamaha Vertragshändlern in den jeweiligen Bestimmungsländern erhältlich.

Para detalles sobre productos, contacte su tienda Yamaha más cercana o el distribuidor autorizado que se lista debajo.

NORTH AMERICA

CANADA

Yamaha Canada Music Ltd.
135 Milner Avenue, Scarborough, Ontario,
M1S 3R1, Canada
Tel: 416-298-1311

U.S.A.

Yamaha Corporation of America
6600 Orangethorpe Ave., Buena Park, Calif.
90620, U.S.A.
Tel: 714-522-9011

CENTRAL & SOUTH AMERICA

MEXICO

Yamaha de Mexico S.A. De C.V.,
Departamento de ventas
Javier Rojo Gomez No.1149, Col. Gpe Del
Moral, Deleg. Iztapalapa, 09300 Mexico, D.F.
Tel: 686-00-33

BRAZIL

Yamaha Musical do Brasil LTDA.
Av. Reboças 2636, São Paulo, Brasil
Tel: 011-853-1377

ARGENTINA

Yamaha Music Argentina S.A.
Viamonte 1145 Piso2-B 1053,
Buenos Aires, Argentina
Tel: 1-371-7021

PANAMA AND OTHER LATIN AMERICAN COUNTRIES/ CARIBBEAN COUNTRIES

Yamaha de Panama S.A.
Torre Banco General, Piso 7, Urbanización Marbella,
Calle 47 y Aquilino de la Guardia,
Ciudad de Panamá*, Panamá*
Tel: 507-269-5311

EUROPE

THE UNITED KINGDOM

Yamaha-Kemble Music (U.K.) Ltd.
Sherbourne Drive, Tilbrook, Milton Keynes,
MK7 8BL, England
Tel: 01908-366700

IRELAND

Danfay Ltd.
61D, Sallynoggin Road, Dun Laoghaire, Co. Dublin
Tel: 01-2859177

GERMANY/SWITZERLAND

Yamaha Europa GmbH.
Siemensstraße 22-34, 25462 Rellingen,
F.R. of Germany
Tel: 04101-3030

AUSTRIA

Yamaha Music Austria
Schleiergasse 20, A-1100 Wien Austria
Tel: 01-60203900

THE NETHERLANDS

Yamaha Music Nederland
Kanaalweg 18G, 3526KL, Utrecht, The Netherlands
Tel: 030-2828411

BELGIUM

Yamaha Music Belgium
Keiberg Imperiastraat 8, 1930 Zaventem, Belgium
Tel: 02-7258220

FRANCE

**Yamaha Musique France,
Division Professionnelle**
BP 70-77312 Marne-la-Vallée Cedex 2, France
Tel: 01-64-61-4000

ITALY

**Yamaha Musica Italia S.P.A.,
Combo Division**
Viale Italia 88, 20020 Lainate (Milano), Italy
Tel: 02-935-771

SPAIN/PORTUGAL

Yamaha-Hazen Electronica Musical, S.A.
Jorge Juan 30, 28001, Madrid, Spain
Tel: 91-577-7270

GREECE

Philippe Nakas S.A.
Navarinou Street 13, P.Code 10680, Athens,
Greece
Tel: 01-364-7111

SWEDEN

Yamaha Scandinavia AB
J. A. Wettergrens Gata 1
Box 30053
S-400 43 Göteborg, Sweden
Tel: 031 89 34 00

DENMARK

YS Copenhagen Liaison Office
Generatorvej 8B
DK-2730 Herlev, Denmark
Tel: 44 92 49 00

FINLAND

F-Musiikki Oy
Kluuvikatu 6, P.O. Box 260,
SF-00101 Helsinki, Finland
Tel: 09 618511

NORWAY

Norsk filial av Yamaha Scandinavia AB
Grini Næringspark 1
N-1345 Østerås, Norway
Tel: 67 16 77 70

ICELAND

Skifan HF
Skeifan 17 P.O. Box 8120
IS-128 Reykjavik, Iceland
Tel: 525 5000

OTHER EUROPEAN COUNTRIES

Yamaha Europa GmbH.
Siemensstraße 22-34, 25462 Rellingen, F.R. of
Germany
Tel: 04101-3030

AFRICA

**Yamaha Corporation,
International Marketing Division**
Nakazawa-cho 10-1, Hamamatsu, Japan 430-
8650
Tel: 053-460-2312

MIDDLE EAST

TURKEY/CYPRUS

Yamaha Europa GmbH.
Siemensstraße 22-34, 25462 Rellingen,
F.R. of Germany
Tel: 04101-3030

OTHER COUNTRIES

Yamaha Music Gulf FZE
LB21-128 Jebel Ali Freezone
P.O.Box 17328, Dubai, U.A.E.
Tel: 971-4-81-5868

ASIA

HONG KONG

Tom Lee Music Co., Ltd.
11/F., Silvercord Tower 1, 30 Canton Road,
Tsimshatsui, Kowloon, Hong Kong
Tel: 2737-7688

INDONESIA

**PT. Yamaha Music Indonesia (Distributor)
PT. Nusantik**
Gedung Yamaha Music Center, Jalan Jend. Gatot
Subroto Kav. 4, Jakarta 12930, Indonesia
Tel: 21-520-2577

KOREA

Cosmos Corporation
1461-9, Seocho Dong, Seocho Gu, Seoul, Korea
Tel: 02-3486-0011

MALAYSIA

Yamaha Music Malaysia, Sdn., Bhd.
Lot 8, Jalan Perbandaran, 47301 Kelana Jaya,
Petaling Jaya, Selangor, Malaysia
Tel: 3-703-0900

PHILIPPINES

Yupango Music Corporation
339 Gil J. Puyat Avenue, P.O. Box 885 MCPO,
Makati, Metro Manila, Philippines
Tel: 819-7551

SINGAPORE

Yamaha Music Asia Pte., Ltd.
11 Ubi Road #06-00, Meiban Industrial Building,
Singapore
Tel: 65-747-4374

TAIWAN

Yamaha KHS Music Co., Ltd.
10F, 150, Tun-Hwa Northroad,
Taipei, Taiwan, R.O.C.
Tel: 02-2713-8999

THAILAND

Siam Music Yamaha Co., Ltd.
121/60-61 RS Tower 17th Floor,
Ratchadaphisek RD., Dindaeng,
Bangkok 10320, Thailand
Tel: 02-641-2951

THE PEOPLE'S REPUBLIC OF CHINA AND OTHER ASIAN COUNTRIES

**Yamaha Corporation,
International Marketing Division**
Nakazawa-cho 10-1, Hamamatsu, Japan 430-8650
Tel: 053-460-2317

OCEANIA

AUSTRALIA

Yamaha Music Australia Pty. Ltd.
17-33 Market Street, South Melbourne, Vic.
3205, Australia
Tel: 3-699-2388

NEW ZEALAND

Music Houses of N.Z. Ltd.
146/148 Captain Springs Road, Te Papapa,
Auckland, New Zealand
Tel: 9-634-0099

COUNTRIES AND TRUST

TERRITORIES IN PACIFIC OCEAN

**Yamaha Corporation,
International Marketing Group**
Nakazawa-cho 10-1, Hamamatsu, Japan 430-8650
Tel: 053-460-2312

