



DTX

drums

ELECTRONIC PERCUSSION PAD
DTX-MULTI 12

Owner's Manual

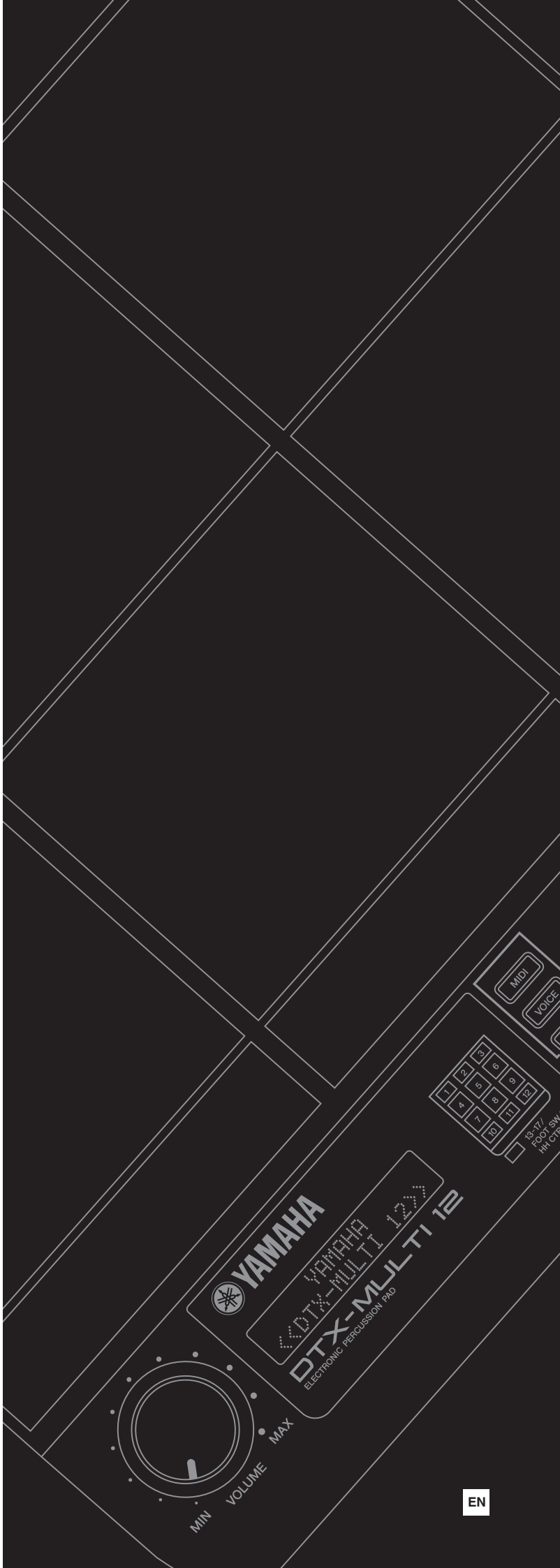

SPECIAL MESSAGE SECTION

This product utilizes batteries or an external power supply (adapter). DO NOT connect this product to any power supply or adapter other than one described in the manual, on the name plate, or specifically recommended by Yamaha.

WARNING: Do not place this product in a position where anyone could walk on, trip over, or roll anything over power or connecting cords of any kind. The use of an extension cord is not recommended! If you must use an extension cord, the minimum wire size for a 25' cord (or less) is 18 AWG. NOTE: The smaller the AWG number, the larger the current handling capacity. For longer extension cords, consult a local electrician.

This product should be used only with the components supplied or; a cart, rack, or stand that is recommended by Yamaha. If a cart, etc., is used, please observe all safety markings and instructions that accompany the accessory product.

SPECIFICATIONS SUBJECT TO CHANGE:

The information contained in this manual is believed to be correct at the time of printing. However, Yamaha reserves the right to change or modify any of the specifications without notice or obligation to update existing units.

This product, either alone or in combination with an amplifier and headphones or speaker/s, may be capable of producing sound levels that could cause permanent hearing loss. DO NOT operate for long periods of time at a high volume level or at a level that is uncomfortable. If you experience any hearing loss or ringing in the ears, you should consult an audiologist.

IMPORTANT: The louder the sound, the shorter the time period before damage occurs.

Some Yamaha products may have benches and / or accessory mounting fixtures that are either supplied with the product or as optional accessories. Some of these items are designed to be dealer assembled or installed. Please make sure that benches are stable and any optional fixtures (where applicable) are well secured BEFORE using. Benches supplied by Yamaha are designed for seating only. No other uses are recommended.

NOTICE:

Service charges incurred due to a lack of knowledge relating to how a function or effect works (when the unit is operating as designed) are not covered by the manufacturer's warranty, and are therefore the owners responsibility. Please study this manual carefully and consult your dealer before requesting service.

ENVIRONMENTAL ISSUES:

Yamaha strives to produce products that are both user safe and environmentally friendly. We sincerely believe that our products and the production methods used to produce them, meet these goals. In keeping with both the letter and the spirit of the law, we want you to be aware of the following:

Battery Notice:

This product MAY contain a small non-rechargeable battery which (if applicable) is soldered in place. The average life span of this type of battery is approximately five years. When replacement becomes necessary, contact a qualified service representative to perform the replacement.

This product may also use "household" type batteries. Some of these may be rechargeable. Make sure that the battery being charged is a rechargeable type and that the charger is intended for the battery being charged.

When installing batteries, do not mix batteries with new, or with batteries of a different type. Batteries MUST be installed correctly. Mismatches or incorrect installation may result in overheating and battery case rupture.

Warning:

Do not attempt to disassemble, or incinerate any battery. Keep all batteries away from children. Dispose of used batteries promptly and as regulated by the laws in your area. Note: Check with any retailer of household type batteries in your area for battery disposal information.

Disposal Notice:

Should this product become damaged beyond repair, or for some reason its useful life is considered to be at an end, please observe all local, state, and federal regulations that relate to the disposal of products that contain lead, batteries, plastics, etc. If your dealer is unable to assist you, please contact Yamaha directly.

NAME PLATE LOCATION:

The name plate is located on the bottom of the product. The model number, serial number, power requirements, etc., are located on this plate. You should record the model number, serial number, and the date of purchase in the spaces provided below and retain this manual as a permanent record of your purchase.

Model

Serial No.

Purchase Date

PLEASE KEEP THIS MANUAL

92-BP (bottom)

FCC INFORMATION (U.S.A.)

1. IMPORTANT NOTICE: DO NOT MODIFY THIS UNIT!

This product, when installed as indicated in the instructions contained in this manual, meets FCC requirements. Modifications not expressly approved by Yamaha may void your authority, granted by the FCC, to use the product.

2. IMPORTANT:

When connecting this product to accessories and/or another product use only high quality shielded cables. Cable/s supplied with this product MUST be used. Follow all installation instructions. Failure to follow instructions could void your FCC authorization to use this product in the USA.

3. NOTE:

This product has been tested and found to comply with the requirements listed in FCC Regulations, Part 15 for Class "B" digital devices. Compliance with these requirements provides a reasonable level of assurance that your use of this product in a residential environment will not result in harmful interference with other electronic devices. This equipment generates/uses radio frequencies and, if not installed and used according to the instructions found in the users manual, may cause interference harmful to the operation of other electronic devices. Compliance with FCC regulations does

not guarantee that interference will not occur in all installations. If this product is found to be the source of interference, which can be determined by turning the unit "OFF" and "ON", please try to eliminate the problem by using one of the following measures:

Relocate either this product or the device that is being affected by the interference.

Utilize power outlets that are on different branch (circuit breaker or fuse) circuits or install AC line filter/s.

In the case of radio or TV interference, relocate/reorient the antenna. If the antenna lead-in is 300 ohm ribbon lead, change the lead-in to co-axial type cable.

If these corrective measures do not produce satisfactory results, please contact the local retailer authorized to distribute this type of product. If you can not locate the appropriate retailer, please contact Yamaha Corporation of America, Electronic Service Division, 6600 Orangethorpe Ave, Buena Park, CA90620

The above statements apply ONLY to those products distributed by Yamaha Corporation of America or its subsidiaries.

* This applies only to products distributed by YAMAHA CORPORATION OF AMERICA.

(class B)

COMPLIANCE INFORMATION STATEMENT (DECLARATION OF CONFORMITY PROCEDURE)

Responsible Party : Yamaha Corporation of America
Address : 6600 Orangethorpe Ave., Buena Park, Calif. 90620
Telephone : 714-522-9011
Type of Equipment : Electronic Percussion Pad
Model Name : DTXM12

This device complies with Part 15 of the FCC Rules.

Operation is subject to the following two conditions:

- 1) this device may not cause harmful interference, and
- 2) this device must accept any interference received including interference that may cause undesired operation.

See user manual instructions if interference to radio reception is suspected.

* This applies only to products distributed by
YAMAHA CORPORATION OF AMERICA.

(FCC DoC)

IMPORTANT NOTICE FOR THE UNITED KINGDOM Connecting the Plug and Cord

IMPORTANT. The wires in this mains lead are coloured in accordance with the following code:

BLUE : NEUTRAL
BROWN : LIVE

As the colours of the wires in the mains lead of this apparatus may not correspond with the coloured markings identifying the terminals in your plug proceed as follows:

The wire which is coloured BLUE must be connected to the terminal which is marked with the letter N or coloured BLACK.

The wire which is coloured BROWN must be connected to the terminal which is marked with the letter L or coloured RED.

Making sure that neither core is connected to the earth terminal of the three pin plug.

* This applies only to products distributed by
YAMAHA CORPORATION OF AMERICA.

(FCC DoC)

* This applies only to products distributed by
Yamaha Music U.K. Ltd.

(2 wires)

Information for Users on Collection and Disposal of Old Equipment



This symbol on the products, packaging, and/or accompanying documents means that used electrical and electronic products should not be mixed with general household waste.

For proper treatment, recovery and recycling of old products, please take them to applicable collection points, in accordance with your national legislation and the Directives 2002/96/EC.

By disposing of these products correctly, you will help to save valuable resources and prevent any potential negative effects on human health and the environment which could otherwise arise from inappropriate waste handling.

For more information about collection and recycling of old products, please contact your local municipality, your waste disposal service or the point of sale where you purchased the items.

[For business users in the European Union]

If you wish to discard electrical and electronic equipment, please contact your dealer or supplier for further information.

[Information on Disposal in other Countries outside the European Union]

This symbol is only valid in the European Union. If you wish to discard these items, please contact your local authorities or dealer and ask for the correct method of disposal.

OBSERVERA!

Apparaten kopplas inte ur växelströmskällan (nätet) så länge som den är ansluten till vägguttaget, även om själva apparaten har stängts av.

ADVARSSEL: Nettpændingen til dette apparat er IKKE afbrudt, så længe netledningen sidder i en stikkontakt, som er tændt — også selvom der er slukket på apparatets afbryder.

VAROITUS: Laitteen toisiopiiriin kytketty käyttökäytin ei irroita koko laitetta verkosta.

(standby)

PRECAUTIONS

PLEASE READ CAREFULLY BEFORE PROCEEDING

* Please keep this manual in a safe place for future reference.



WARNING

Always follow the basic precautions listed below to avoid the possibility of serious injury or even death from electrical shock, short-circuiting, damages, fire or other hazards. These precautions include, but are not limited to, the following:

Power supply/AC power adaptor

- Only use the voltage specified as correct for the instrument. The required voltage is printed on the name plate of the instrument.
- Use the specified adaptor (page 110) only. Using the wrong adaptor can result in damage to the instrument or overheating.
- Check the electric plug periodically and remove any dirt or dust which may have accumulated on it.
- Do not place the AC adaptor cord near heat sources such as heaters or radiators, and do not excessively bend or otherwise damage the cord, place heavy objects on it, or place it in a position where anyone could walk on, trip over, or roll anything over it.

Do not open

- Do not open the instrument or attempt to disassemble the internal parts or modify them in any way. The instrument contains no user-serviceable parts. If it should appear to be malfunctioning, discontinue use immediately and have it inspected by qualified Yamaha service personnel.

Water warning

- Do not expose the instrument to rain, use it near water or in damp or wet conditions, or place containers on it containing liquids which might spill into any openings. If any liquid such as water seeps into the instrument, turn off the power immediately and unplug the power cord from the AC outlet. Then have the instrument inspected by qualified Yamaha service personnel.
- Never insert or remove an electric plug with wet hands.

Fire warning

- Do not put burning items, such as candles, on the unit. A burning item may fall over and cause a fire.

If you notice any abnormality

- If the AC adaptor cord or plug becomes frayed or damaged, or if there is a sudden loss of sound during use of the instrument, or if any unusual smells or smoke should appear to be caused by it, immediately turn off the power switch, disconnect the adaptor plug from the outlet, and have the instrument inspected by qualified Yamaha service personnel.



CAUTION

Always follow the basic precautions listed below to avoid the possibility of physical injury to you or others, or damage to the instrument or other property. These precautions include, but are not limited to, the following:

Power supply/AC power adaptor

- When removing the electric plug from the instrument or an outlet, always hold the plug itself and not the cord.
- Unplug the AC power adaptor when not using the instrument, or during electrical storms.
- Do not connect the instrument to an electrical outlet using a multiple-connector. Doing so can result in lower sound quality, or possibly cause overheating in the outlet.

Location

- Do not expose the instrument to excessive dust or vibrations, or extreme cold or heat (such as in direct sunlight, near a heater, or in a car during the day) to prevent the possibility of panel disfiguration or damage to the internal components.
- Do not use the instrument in the vicinity of a TV, radio, stereo equipment, mobile phone, or other electric devices. Otherwise, the instrument, TV, or radio may generate noise.
- Do not place the instrument in an unstable position where it might accidentally fall over.
- Before moving the instrument, remove all connected adaptor and other cables.

- When setting up the product, make sure that the AC outlet you are using is easily accessible. If some trouble or malfunction occurs, immediately turn off the power switch and disconnect the plug from the outlet. Even when the power switch is turned off, electricity is still flowing to the product at the minimum level. When you are not using the product for a long time, make sure to unplug the power cord from the wall AC outlet.
- Use only the stand/rack specified for the instrument. When attaching the stand or rack, use the provided screws only. Failure to do so could cause damage to the internal components or result in the instrument falling over.
- Do not place objects in front of the instrument's air vent, since this may prevent adequate ventilation of the internal components, and possibly result in the instrument overheating.

Connections

- Before connecting the instrument to other electronic components, turn off the power for all components. Before turning the power on or off for all components, set all volume levels to minimum. Also, be sure to set the volumes of all components at their minimum levels and gradually raise the volume controls while playing the instrument to set the desired listening level.

Maintenance

- When cleaning the instrument, use a soft, dry cloth. Do not use paint thinners, solvents, cleaning fluids, or chemical-impregnated wiping cloths.

Handling caution

- Never insert or drop paper, metallic, or other objects into the gaps on the panel or keyboard. If this happens, turn off the power immediately and unplug the power cord from the AC outlet. Then have the instrument inspected by qualified Yamaha service personnel.
- Do not place vinyl, plastic or rubber objects on the instrument, since this might discolor the panel or keyboard.
- Do not rest your weight on, or place heavy objects on the instrument, and do not use excessive force on the buttons, switches or connectors.
- Do not use the instrument/device or headphones for a long period of time at a high or uncomfortable volume level, since this can cause permanent hearing loss. If you experience any hearing loss or ringing in the ears, consult a physician.

Saving data

Saving and backing up your data

- Saved data may be lost due to malfunction or incorrect operation. Save important data to external USB storage device.

Backing up the USB storage device

- To protect against data loss through media damage, we recommend that you save your important data onto two USB storage devices.

Yamaha cannot be held responsible for damage caused by improper use or modifications to the instrument, or data that is lost or destroyed.

Always turn the power off when the instrument is not in use.

Even when the power switch is in the standby position, electricity is still flowing to the instrument at the minimum level. When you are not using the instrument for a long time, make sure you unplug the AC power adaptor from the wall AC outlet.

■ Latest Firmware Version

From time to time, Yamaha may update product firmware without prior notice. We recommend, therefore, that you check our web site (below) for the latest version and keep your DTX-MULTI 12 firmware up to date.

<http://dtxdrums.yamaha.com>

The content of this Owner's Manual applies to the newest version of the firmware as of printing. Details regarding any functions added to later versions will also be made available via the above web site.

■ Optional Pads

Within this Owner's Manual, the optional external pads that may be connected to the DTX-MULTI 12 are referred to by model name. Please note that these model names were up-to-date as of printing of this manual. Details regarding any subsequently released models will be made available via the following web site.

<http://dtxdrums.yamaha.com>

Special Notice

- *This Owner's Manual and all content thereof is copyright of Yamaha Corporation.*
- *The illustrations and LCD screens as shown in this Owner's Manual are for instructional purposes only and may appear somewhat different from those on your instrument.*
- *This product incorporates and bundles computer software and other content for which Yamaha retains the copyright or, with respect to which, has license to use others' copyrights. Such copyrighted materials include, but are not limited to, all computer software, style files, MIDI data, wave data, musical scores, and sound recordings. Any unauthorized use of said software and content for non-personal applications is prohibited under applicable laws. Any violation of copyright has legal consequences. DO NOT MAKE, DISTRIBUTE, OR USE ILLEGAL COPIES.*
- *This device is capable of using various musical-data types and formats by optimization thereof in advance to a specific proprietary format. As a result, this instrument may not play back said data exactly as the producers or composers thereof originally intended.*
- *Copying of commercially available musical data including, but not limited to, MIDI data and/or audio data is strictly prohibited except when intended for personal use.*
- *The company names and product names in this manual are the trademarks or registered trademarks of their respective companies.*

Welcome

Thank you for purchasing the Yamaha DTX-MULTI 12 Electronic Percussion Pad.

To get the most out of your new instrument, please read this owner's manual carefully. And after reading this document, be sure to store it in a safe place so that you can refer back to it again as needed.

Additional Package Contents

- Power adaptor
- Owner's Manual (this document)
- Data List booklet
- DVD-ROM (containing software)

Features of the DTX-MULTI 12

12 built-in pads and versatile input connectors

The DTX-MULTI 12 features 12 built-in pads that have been conveniently arranged for ease-of-use in a wide variety of performance situations. On the rear panel, furthermore, you will find input connectors for five additional Yamaha electronic drum pads and drum triggers. By combining separately-sold pads and drum triggers with a central DTX-MULTI 12 unit, you can create your own compact electronic drum kit and also integrate acoustic drums. Furthermore, with a foot switch jack and a hi-hat controller jack also included, you can use foot switches and controllers to select drum kits, to simulate hi-hat playing techniques, and to enhance your performances in a wide range of other ways.

High-quality sound

In addition to a broad spectrum of voices from the top-of-the-line DTXEXTREME III Drum Trigger Module, the DTX-MULTI 12 also features many newly-sampled percussion sounds and versatile, ready-to-use effect sounds for a grand total of 1,277 voices. What's more, this rich variety of sounds also includes timpani, marimba, vibraphone, and many other chromatic percussion instruments. Together with great-sounding Reverb and Chorus effects that can be applied to entire drum kits, the DTX-MULTI 12 also features a Variation effect unit that can be used to enhance individual voices in many exciting ways.

Wide selection of patterns

The DTX-MULTI 12 comes complete with 128 ready-to-use melodic and rhythmic phrases (including 3 demos) known as patterns. You can easily start and stop patterns by simply striking pads to which they are assigned, greatly adding to the expressiveness of your performances. In addition, you can also record your own performances as patterns and assign them to pads in order to conveniently add original grooves to your drum kits.

Powerful USB expandability

Using the USB TO HOST port and a USB cable (sold separately), the DTX-MULTI 12 can be conveniently connected to a computer. This affords you a much greater level of efficiency and speed when recording performances and carrying out many other music-production processes using computer-based DAW (digital audio workstation) software such as Cubase AI, which is bundled with your DTX-MULTI 12.

A USB TO DEVICE port allows USB memory devices to be plugged in for flexible data exchange. This allows you to store your DTX-MULTI 12 settings on such a device as standard computer files; furthermore, you can also import WAV or AIFF audio files from a USB memory device and assign them to individual pads, thus adding a unique, highly personal flavor to your performances.

Versatile triggering for enhanced musical possibilities

With the Stack function, each pad can produce up to four different sounds; meanwhile, the Alternate function triggers different sounds each time a pad is struck. In addition, you can setup the instrument to automatically select different sounds based on how hard or soft you strike the corresponding pad or in response to foot-switch operation.

The DTX-MULTI 12 can also be setup to allow sounds to be silenced when a hand is pressed down on the pad and to allow different sounds to be produced when a hand is pressed down on a pad as it is struck. And you are not restricted to drumsticks alone! The DTX-MULTI 12 can be easily setup to support a rich variety of hand playing styles.

Contents

Additional Package Contents	6
Features of the DTX-MULTI 12.....	6
Component Names & Functions.....	8
Setting Up.....	10
Using with Acoustic Drums	10
Power supply.....	10
Connecting Speakers and/or Headphones	10
Connecting to Other Audio Equipment.....	10
Turning on the DTX-MULTI 12.....	11
Connecting a USB Memory Device.....	11
Connecting Other MIDI Devices.....	12
Connecting to a Computer	13
Making Music with a Computer.....	13
Setting up Cubase Remote Control	15
Quick Guide	
Producing Sounds with the Pads.....	16
Listening to Patterns	20
Making Your Own Patterns	21
Saving Your Data on a USB Memory Device.....	23
Importing Audio Files.....	25
Reference	
Internal Design	27
Functional Blocks	27
Pads & Trigger Signals	28
Sounds Produced Using the Pads	31
Kit Makeup	32
Effects	36
Internal Memory	42
Basic Operations	44
KIT Setting Area (KIT).....	46
Makeup of KIT Setting Area	46
KIT1 Select Kit	47
KIT2 Kit Volume, Tempo & Name	47
KIT3 Effect Send Levels.....	48
KIT4 Variation Effect Setup.....	48
KIT5 Chorus Effect Setup	49
KIT6 Reverb Effect Setup	50
KIT7 Other Drum Kit Settings.....	51
KIT8 Kit Management	53
VOICE Setting Area (VCE).....	55
Makeup of VOICE Setting Area	55
VCE1 Select Voice.....	56
VCE2 Voice Tuning, Volume & Pan.....	57
VCE3 Voice Timbre.....	58
VCE4 Effect Send Levels.....	59
VCE5 Other Voice-Related Settings	60
MIDI Setting Area (MIDI).....	61
Structure of MIDI Setting Area	61
MIDI1 Select Message Type	62
MIDI2 MIDI Destination Switches.....	66
MIDI3 Other MIDI Settings	67
WAVE Setting Area (WAVE)	69
Makeup of WAVE Setting Area	69
WAVE1 Wave Selection & Playback.....	70
WAVE2 Playback Mode, Trim Points & Name	70
WAVE3 Other Wave-Related Tasks	71
WAVE4 Wave Memory Status	73
PATTERN Setting Area (PTN).....	74
Makeup of PATTERN Setting Area	74
PTN1 Select Pattern.....	75
PTN2 Looping, Tempo & Pattern Names.....	75
PTN3 MIDI Settings for Patterns	76
PTN4 Pattern Quantization & Management	78
PTN5 Pattern Memory Status	81
UTILITY Setting Area (UTIL).....	82
Makeup of UTILITY Setting Area	82
UTIL1 System Settings.....	83
UTIL2 Click Track Settings.....	84
UTIL3 Master Equalization	86
UTIL4 Pad Utilities.....	88
UTIL5 Hi-hat Setup.....	89
UTIL6 Instrument MIDI Setup.....	90
UTIL7 File Management.....	92
UTIL8 Instrument Reset	98
TRIGGER Setting Area (TRG)	99
Makeup of TRIGGER Setting Area	99
TRG1 Select Trigger Setup	100
TRG2 Pad Setup	100
TRG3 Trigger Setup Names.....	104
TRG4 Copy Trigger Parameters	104
Troubleshooting	105
On-screen Messages.....	108
Specifications	110
Index	111

Component Names & Functions

■ Front Panel

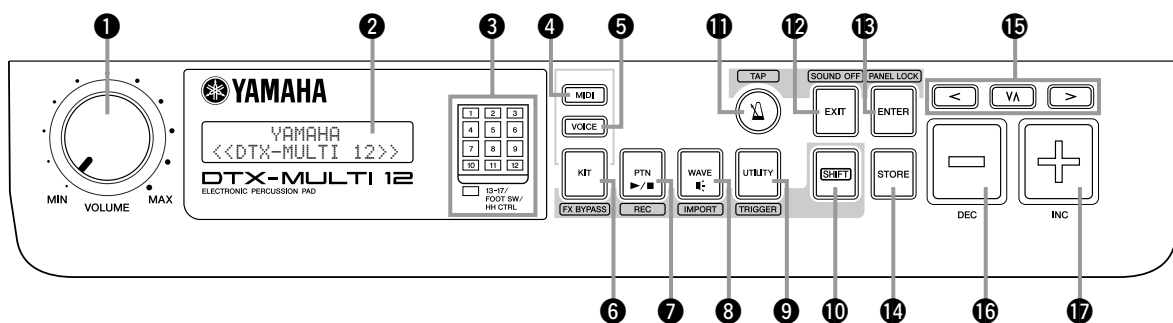

1 VOLUME Dial

This dial controls the master volume (i.e., the volume at the OUTPUT jacks). Turn the dial clockwise to increase the volume or counter-clockwise to decrease it.

2 Display

This LCD screen shows information and data needed for operation.

3 Pad Indicator

This array of LEDs shows the pads that have been struck and are currently producing a sound. The displayed numbers 1 to 12 correspond to the twelve main and rim pads on the instrument itself. In addition, the lamp [13-17] turns on in response to playing of expansion pads (sold-separately), which are connected via the PAD jacks on the rear panel, or to signals from a foot switch or hi-hat controller (sold-separately), which is connected via the FOOT SW or HI-HAT CONTROL jack, also on the rear panel.

NOTE

- Before use, be sure to remove the transparent film applied to the indicator panel to protect it during transportation.

4 [MIDI] Button

This button is used to access the MIDI setting area (see page 61). In addition, you can turn on and off the Cubase Remote function by holding down the [SHIFT] button and pressing the [MIDI] button. When this function is turned on, the buttons on the DTX-MULTI 12 front panel can be used to control Cubase operations (see page 15).

5 [VOICE] Button

This button is used to access the Voice setting area (see page 55).

6 [KIT] Button

This button is used to access the Kit setting area (see page 46). In addition, you can toggle effects applied to the current drum kit on and off by holding down the [SHIFT] button and pressing the [KIT] button (see page 83).

7 [PTN] Button

The Pattern button is used to access the Pattern setting area (see page 74). In addition, you can also activate Record Mode by holding down the [SHIFT] button and pressing the [PTN] button (see page 21).

8 [WAVE] Button

This button is used to access the Wave setting area (see page 69). In addition, you can also open the Import page by holding down the [SHIFT] button and pressing the [WAVE] button (see page 25).

9 [UTILITY] Button

This button is used to access the Utility setting area (see page 82). In addition, you can also access the Trigger setting area by holding down the [SHIFT] button and pressing the [UTILITY] button (see page 99).

10 [SHIFT] Button

Hold down this button and press another button to access the setting area or function indicated above or below it.

11 [TAP] Button

The Click-track button is used to start and stop the built-in click-track (or metronome). In addition, you can also activate the Tap Tempo function by holding down the [SHIFT] button and pressing the [TAP] button.

12 [EXIT] Button

The parameter-setting pages in each setting area are arranged in a hierarchical structure. Press this button to leave the current page and move one step back towards the top of the setting area. In addition, you can instantly turn off all sound by holding down the [SHIFT] button and pressing the [EXIT] button.

13 [ENTER] Button

This button is used to execute processes and confirm values. In addition, you can activate the Panel Lock function to lock and unlock the front panel by holding down the [SHIFT] button and pressing the [ENTER] button. In this way, the front panel can be deactivated during performances in order to avoid making unintentional changes to settings. Even with the Panel Lock activated, the [KIT] and [VOICE] buttons can be used to access the corresponding setting areas; however, you will only be able to change the current kit using the [-/DEC] and [+/INC] buttons or visually confirm the voice assigned to struck pads. To check voices with the Panel Lock activated, press the [VOICE] button.

14 [STORE] Button

This button is used to store settings and other data in the DTX-MULTI 12's internal memory. In addition, this button will light up whenever parameters have been changed but not yet stored.

15 [<] [VA] [>] Buttons

- These selector buttons are used to navigate between parameter-setting pages and parameters in the various setting areas.
- You can activate and deactivate Input Lock mode by holding down the [SHIFT] button and pressing the [VA] button (see page 103).
- With a parameter-setting page displayed, you can move to the first parameter-setting page of the previous or next parameter section in the current setting area by holding down the [SHIFT] button and pressing the [<] or [>] button.

16 [-/DEC] Button

This button is used when setting parameters to decrease the value at the cursor position. In addition, the selected value can be decreased in units of 10 by holding down the [SHIFT] button and pressing the [-/DEC] button or by holding down the [-/DEC] button and pressing the [+ /INC] button.

17 [+ /INC] Button

This button is used when setting parameters to increase the value at the cursor position. In addition, the selected value can be increased in units of 10 by holding down the [SHIFT] button and pressing the [+ /INC] button or by holding down the [+ /INC] button and pressing the [-/DEC] button.

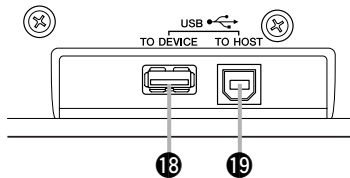
Side Panel**18 USB TO DEVICE Port**

This port is used to plug in a USB memory device (such as a flash drive or external hard disk), either directly or via a USB cable. When connected in this way, you will be able to save data created on the DTX-MULTI 12 to the USB memory device and to import settings, sound files, and the like.

19 USB TO HOST Port

This port is used to connect the DTX-MULTI 12 to a computer via a USB cable. When connected in this way, you will be able to exchange MIDI data between the instrument and your computer.

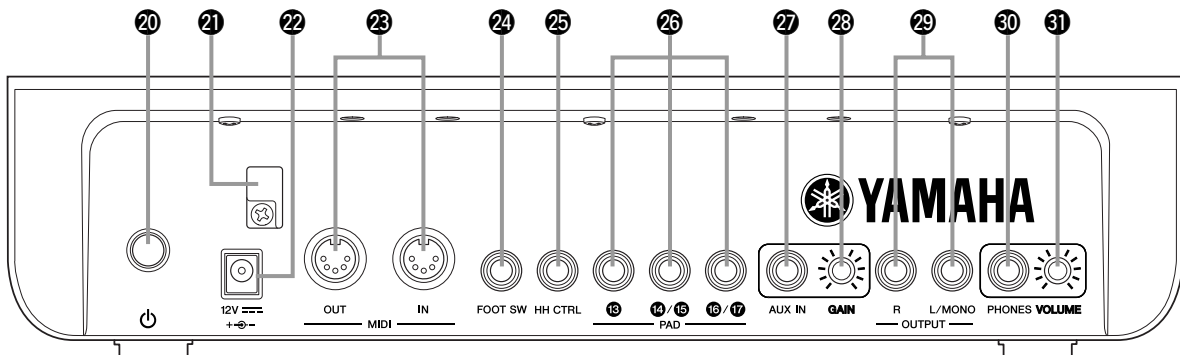
Rear Panel**20 Standby/On Switch**

Use this switch to turn your DTX-MULTI 12 on () and off ().

21 Cord Clip

Wrap the cord from the power adaptor around this clip to prevent accidental unplugging during use.

22 DC IN Terminal

Connect the power cord from the power adaptor (provided) to this terminal.

23 MIDI IN/OUT Connectors

The MIDI IN connector is used to receive control or performance data from another MIDI device, such as an external sequencer, via a MIDI cable. When connected in this way, you can play the internal tone generator and control a wide range of parameters using another MIDI device. Meanwhile, the MIDI OUT connector is used to send performance data from this instrument to other devices in the form of MIDI messages.

24 FOOT SW Jack

The Foot Switch jack is used to connect an optional foot switch (FC4, FC5, FC7, etc.) or hi-hat controller (HH65, etc.) to the DTX-MULTI 12.

25 HI-HAT CONTROL Jack

The Hi-hat Control jack is used to connect an optional hi-hat controller (HH65, etc.).

26 PAD JACKS (13 to 17)

These trigger-input jacks are used to connect optional pads. The PAD 13 jack is compatible both with mono and stereo (two- and three-zone) types; meanwhile, the PAD 14/15 and the PAD 16/17 jacks support standard mono-output pads (see page 30).

27 AUX IN Jack

External audio signals can be input via this standard stereo-telephone plug. In this way, you can connect an MP3 or CD player to play along with your favorite tunes.

28 GAIN Knob

Use this knob to adjust the gain level for audio being input via the AUX IN jack. This adjustment may be necessary given that external audio devices output signals at a wide range of different volumes. Increase the gain by rotating the knob clockwise, and decrease it by rotating the knob counter-clockwise.

29 OUTPUT L/MONO and R JACKS

Use these jacks to output line-level stereo mixes. For example, you can connect each of the jacks to the left and right inputs of an external stereo amplifier or mixer using mono audio-jack cables. For mono output, use the L/MONO jack only.

30 PHONES Jack

Use this standard audio jack to connect a pair of stereo headphones.

31 VOLUME Knob

Use this knob to adjust the level of audio output from the PHONES jack. Increase the volume by rotating the knob clockwise, and decrease it by rotating the knob counter-clockwise.

Setting Up

Using with Acoustic Drums

If you intend to use your DTX-MULTI 12 together with a set of acoustic drums, you can attach an MAT1 Module Attachment (sold separately) to the bottom of the unit so that it can be conveniently assembled to a tom holder or a stand. For details regarding assembly, refer to the owner's manual that comes with the MAT1.

Power supply

- 1 Ensure that the  (Standby/On) switch on the rear panel is turned off.

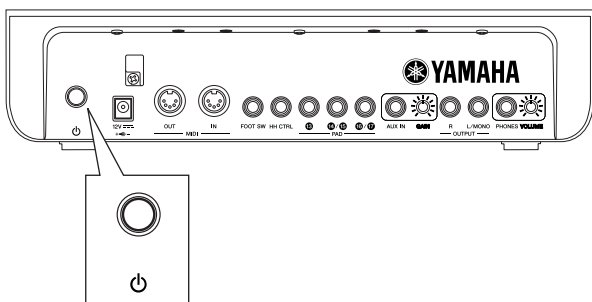

- 2 Connect the DC power cord from the power adaptor (included) to the DC IN terminal on the rear panel. To prevent the cord from being accidentally unplugged, wrap it around the cord clip.

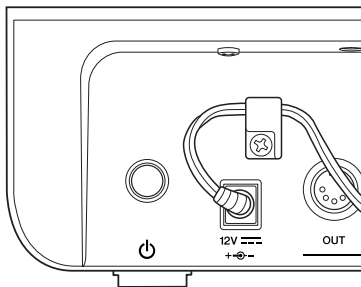

CAUTION

- Ensure that the power cord is not bent at an extreme angle when wrapped around the clip. Excessive bending can damage the cord and create a fire hazard.

- 3 Plug the adaptor's AC power cord into an AC wall socket or another electrical outlet.

WARNING

- Use only the power adaptor provided. Operation with other adaptors may damage the instrument, cause it to overheat, or create a fire hazard.
- Ensure that the power supply is correct for the power adaptor provided.
- The DTX-MULTI 12 remains charged and draws a small amount of power even when the  (Standby/On) switch is in the Off position. If it is not to be used for an extended period of time, therefore, be sure to unplug the AC power adaptor from the power supply.

Connecting Speakers and/or Headphones

The DTX-MULTI 12 has no built-in speakers. In order to hear it, therefore, you will need to connect headphones or an external amplifier and speakers. (See the connection diagram below.)

CAUTION

- Whenever making connections, ensure that the plugs on the cables being used match the DTX-MULTI 12's output jacks.

● OUTPUT L/MONO and R Jacks (standard mono audio jacks)

Use these jacks to connect your instrument to an external amplifier and speakers in order to hear yourself play. If the amplifier has only a single input jack, be sure to connect it via the OUTPUT L/MONO jack.

● PHONES Jack (standard stereo audio jack)

Use this audio jack to connect a pair of stereo headphones. The headphone volume can be adjusted using the VOLUME knob on the rear panel.

CAUTION

- To prevent hearing loss, avoid using headphones at high volumes for extended periods of time.

Connecting to Other Audio Equipment

Audio input from an MP3 or CD player via the AUX IN jack can be mixed with the sound produced by the DTX-MULTI 12 and output together from the OUTPUT (L/MONO and R) and PHONES jacks. This makes it very easy to play along with your favorite tunes. If necessary, furthermore, you can adjust the input volume using the GAIN knob.

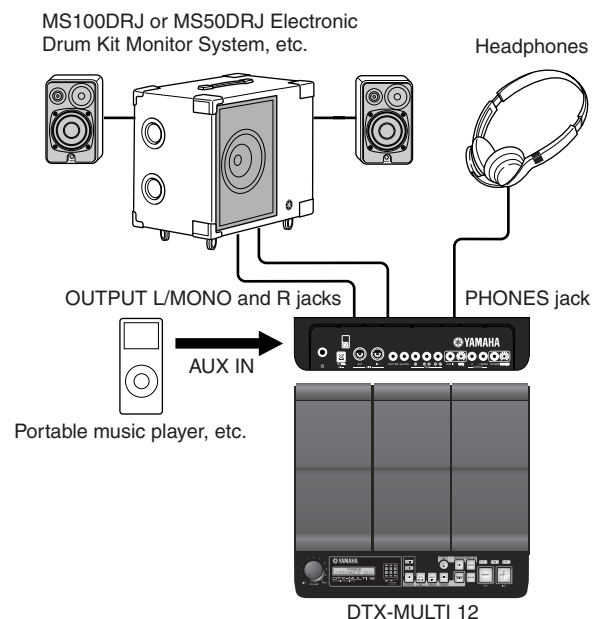

Turning on the DTX-MULTI 12

1 After you have connected speakers, an audio player, and any other necessary equipment, turn the volume of the DTX-MULTI 12 itself and the other devices fully down as a precaution.

2 Press the **⏻** (Standby/On) switch on the DTX-MULTI 12's rear panel to turn it on.

The opening screen will be displayed, followed by the Select Kit page (from the KIT setting area).

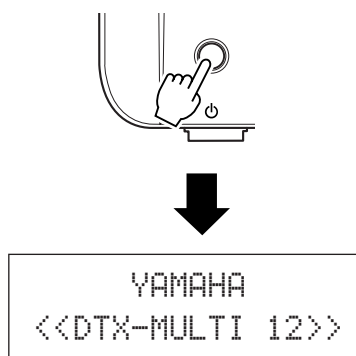

Connecting a mixer or other MIDI devices

Ensure that the volume on all devices is turned fully down. Then, turn on the devices one-by-one in the following sequence: ① MIDI controllers (master devices), ② MIDI receivers (slave devices), ③ audio equipment (mixers, amplifiers, speakers, etc.).

NOTE

- When turning off your system, first turn the volume of each audio device fully down, and then switch off the devices one-by-one in the reverse order to above (i.e., starting with the audio equipment).

Connecting a USB Memory Device

You can plug a USB memory device into the USB TO DEVICE port on the side panel of your DTX-MULTI 12.

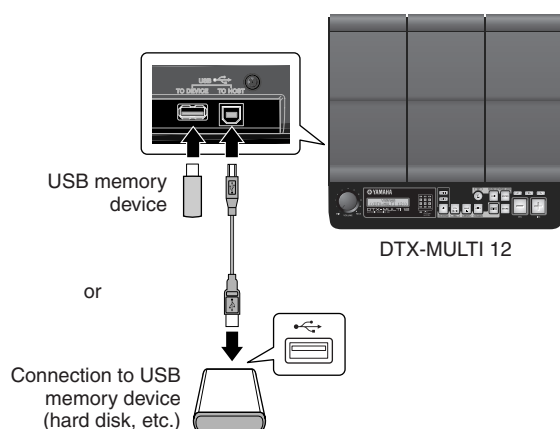

Precautions When Using USB TO DEVICE Port

Whenever connecting a USB device via the USB TO DEVICE port, be sure to handle it with care and to observe the following important precautions.

NOTE

- For more details on how to use your USB device, refer to the owner's manual that came with it.

Supported USB devices

Flash drives, external hard disks, and other USB-compatible, mass-storage devices may be plugged in for use with this instrument.

The DTX-MULTI 12 does not necessarily support all commercially available USB memory devices, and Yamaha cannot guarantee the operation of all such devices that can be purchased. Before purchasing a USB device for use with this instrument, therefore, please check with your Yamaha dealer or an authorized Yamaha distributor (see list at end of the Owner's Manual) or visit the following web page:

<http://dtxdrums.yamaha.com>

NOTE

- Other USB devices, such as a computer keyboard or mouse, cannot be used.

Connecting a USB memory device

Before plugging in a USB memory device, ensure that its connector matches the instrument's USB TO DEVICE port and that both are oriented in the same direction.

This port supports the USB 1.1 standard; however, you can also plug in and use USB 2.0 memory devices. It should be noted that data will be transferred at the USB 1.1 speed in such a case.

Using a USB Memory Device

With a USB memory device plugged in, you will be able to save data that you have created and to import both settings and audio data.

NOTE

- Although USB-type CD-R and CD-RW drives can be used to load data into the instrument, they cannot be used to save data directly. You can, however, transfer data to a computer featuring a CD-R or CD-RW drive in order to write it to this type of media.

Formatting USB Memory Devices

Certain types of USB memory device must be formatted before they can be used with this instrument. For details on how to do this, see page 97.

CAUTION

- When a USB memory device is formatted, all data stored on it will be permanently erased. Before formatting such a device, therefore, ensure that any important data contained on it has been copied to another location.

● Write Protection

Certain types of USB memory device can be write-protected to prevent data from being accidentally erased. If your USB memory device contains important data, we suggest that you use write protection to prevent accidental erasure. Meanwhile, if you need to save data on such a device, be sure to disable the write-protect function.

⚠ CAUTION

- If using a self-powered type of USB memory device, avoid turning it on and off repeatedly. In addition, avoid frequent plugging and unplugging of USB cables. If this precaution is not observed, the DTX-MULTI 12 may freeze and stop operating.
- Never turn off either a plugged-in USB memory device or the DTX-MULTI 12 or unplug the memory device while it is being accessed within the UTILITY setting area in order to save, load, or delete data or to perform formatting. If this precaution is not observed, data on the USB memory device or the DTX-MULTI 12 may be corrupted.

Connecting Other MIDI Devices

Using standard MIDI cables (sold separately), you can connect other MIDI devices via the MIDI IN and MIDI OUT connectors. When connected in this way, the DTX-MULTI 12 can be used to control synthesizers and other sound modules. Meanwhile, the instrument's internal tone generator can be played using other connected MIDI devices. These and many other MIDI functions allow for an even greater range of performance and recording possibilities.

NOTE

- In addition to the two built-in MIDI connectors, the USB TO HOST port can also be used to exchange MIDI data. Selection of whether to use the MIDI connectors or the USB TO HOST port for this purpose is performed on the MIDI In/Out page from the MIDI section of the UTILITY setting area (see page 91).

■ To Control a Sound Module or Synthesizer

Using a MIDI cable, connect the MIDI OUT connector on the DTX-MULTI 12 to the MIDI IN connector on the device you want to control or play.

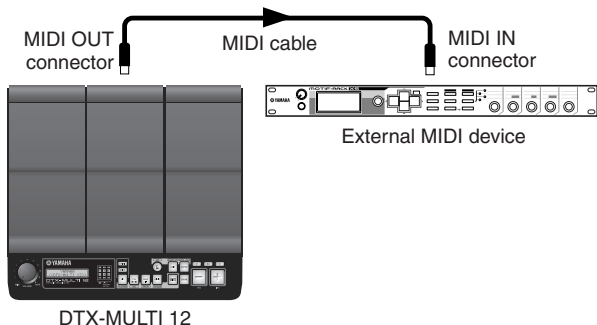

■ To Control the DTX-MULTI 12 from Another MIDI Device

Using a MIDI cable, connect the MIDI IN connector on the DTX-MULTI 12 to the MIDI OUT connector on the controller device.

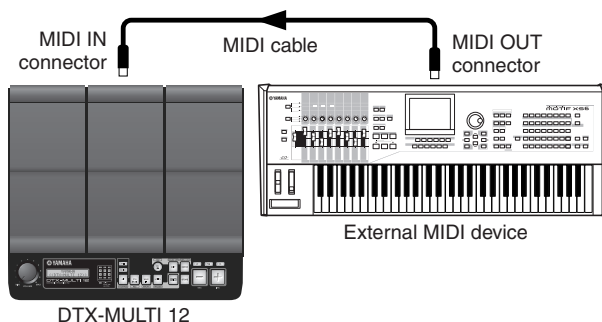

● Synchronizing with Other MIDI Devices (Master and slave devices)

The playback of patterns on the DTX-MULTI 12 can be synchronized with playback on an external MIDI device. This instrument and other MIDI devices use an internal clock to control the tempo of playback, and when two such devices are synchronized, it is necessary to specify which clock will be used by both. The device set to use its own internal clock serves as a reference for all connected devices and is referred to as the “master” instrument. Connected devices set to use an external clock are referred to as “slaves”. For example, if devices were connected as shown above and you wanted to record playback data from the external MIDI device as a pattern on the DTX-MULTI 12, it would be necessary to set the external MIDI device as the master; furthermore, the DTX-MULTI 12 would need to be setup to use an external clock for synchronization. To do so, first of all press the [UTILITY] button to access the UTILITY setting area, navigate to the MIDI section (UTIL6) using the [<]/[>] buttons, and press the [ENTER] button. Next, navigate to the MIDI Sync page (UTIL6-6) using the [<]/[>] buttons, and set the MIDI Sync parameter to either “ext” or “auto”.

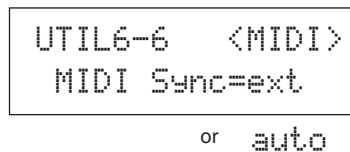

NOTE

- The MIDI Sync parameter is set to “auto” by default.

Connecting to a Computer

Although the DTX-MULTI 12 is exceptionally powerful and versatile all by itself, connecting it to a computer via USB allows for even greater power and versatility. When connected in this way, MIDI data can be freely transferred between the instrument and the computer. In this section, you'll learn how to make the necessary connections.

NOTE

- As the DTX-MULTI 12 has no built-in speakers, you will need to connect headphones or an external amplifier and speakers in order to hear it. For details, see page 10.
- A USB cable is not included. In order to connect to a computer, use a USB A-B cable of no more than 3 meters in length.

1 Download the latest version of the USB-MIDI driver to your computer from the following web page. After clicking the Download button, save the compressed file in a convenient location and then expand it.

http://www.global.yamaha.com/download/usb_midi/

NOTE

- Information on system requirements is also provided on the above web page.
- The USB-MIDI driver may be revised and updated without prior notice. Before installing, visit the above web page to confirm the latest related information and ensure that you have the most up-to-date version.

2 Install the USB MIDI driver on your computer.

For instructions on installing, refer to the guide included with the driver installer. When the guide indicates that your Yamaha product should be connected to the computer, do so as shown below.

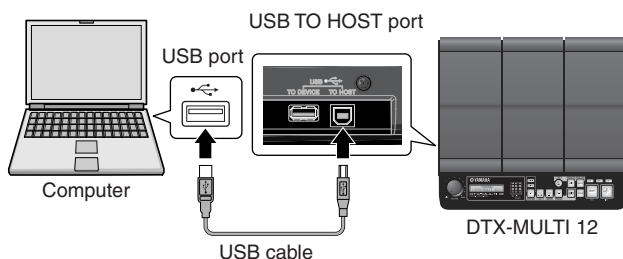

3 To enable the exchange of MIDI data via the USB TO HOST port, press the [UTILITY] button to access the UTILITY setting area and then navigate to the MIDI In/Out page (UTIL6-9).

```
UTIL6-9  <MIDI>
MIDI IN/OUT=MIDI
```

4 Set the MIDI IN/OUT parameter to "USB" (using the [+/INC] button if necessary).

```
UTIL6-9  <MIDI>
MIDI IN/OUT=USB
```

5 Press the [STORE] button and store this setting.



■ Precautions When Using USB TO HOST Port

When connecting to a computer via the USB TO HOST port, be sure to observe the precautions listed below. Failing to do so risks freezing your computer and corrupting or losing data. If your computer or DTX-MULTI 12 should freeze, restart the application being used, reboot the computer, or turn the instrument off once and then back on.

⚠ CAUTION

- Use a USB A-B cable of no more than 3 meters in length.
- Before connecting to the computer via the USB TO HOST port, restore the computer from any power-saving mode (such as Suspend, Sleep, or Standby).
- Connect the computer via the USB TO HOST port before turning on the DTX-MULTI 12.
- Be sure to always perform the following steps before turning the instrument on or off and either plugging or unplugging the USB cable.
 - Quit all applications.
 - Ensure that no data is being sent from the DTX-MULTI 12. (Data is transmitted by striking the pads or playing patterns.)
- When connected to a computer, allow at least 6 seconds to pass between turning the instrument on and off and plugging or unplugging the USB cable.

Making Music with a Computer

■ Recording DTX-MULTI 12 Performance Data using a DAW Application

The following section will describe how to record your performances using a DAW application running on a connected computer.

Normally, when playing in order to record on a computer, performance data produced by striking the pads is first sent to the computer and then returned to the instrument in order to play its internal tone generator. If local control of the DTX-MULTI 12 is turned on (via the Local Control page (UTIL6-5) from the UTILITY area), performance data will also be sent directly to the tone generator, and as a result, the direct and returned data will overlap, making it sound as if the pads are being struck twice.

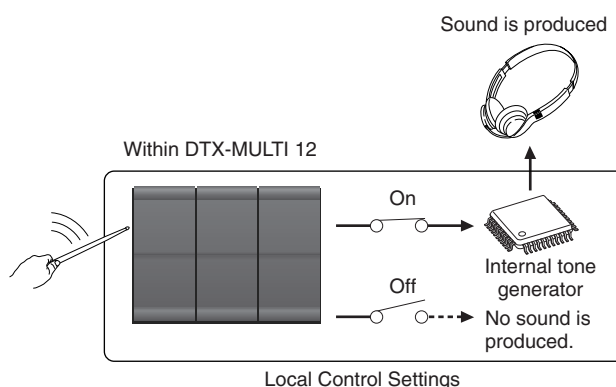

Most DAW applications allow MIDI Thru to be turned on, and therefore, you can setup your system as shown below with local control of the DTX-MULTI 12 turned off and the DAW application returning performance data to the tone generator. In this way, performances can be recorded in comfort without each strike being heard twice.

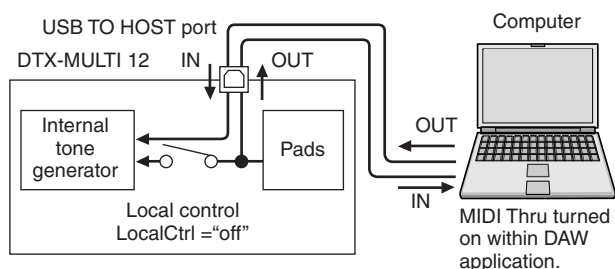

NOTE

• DAW is an abbreviation of digital audio workstation. DAW applications such as Cubase can be used to record, edit, and mix audio and MIDI data on a computer.

We will now describe how to setup parameters for recording your performances, first on the instrument itself, and then within the DAW application.

● **DTX-MULTI 12 settings**

Turn off local control as follows.

- 1 Press the [UTILITY] button to access the UTILITY setting area, navigate to the MIDI section (UTIL6) using the [<]/[>] buttons, and press the [ENTER] button.

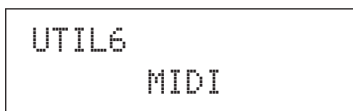

- 2 Navigate to the Local Control page (UTIL6-5) using the [<]/[>] buttons.

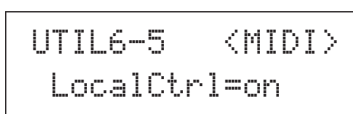

- 3 Set the LocalCtrl parameter to "off" (using the [-/DEC] button if necessary).

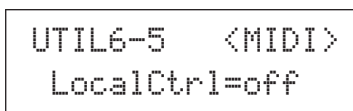

- 4 Press the [STORE] button and store this setting.

With local control turned off in this way, performance data produced by striking the pads will not be sent to the internal tone generator.

● **Setting DAW-Application Parameters**

Within your DAW application, turn on MIDI Thru. This setting ensures that, when performance data is being recorded on a track within your application, it is also returned to the external MIDI system.

For example, let's assume that performance data is being recorded on Track 3 by your DAW application. In addition, we'll also assume that MIDI Channel 1 has been set for the return of performance data. If MIDI Thru is now turned on for Track 3, the DAW application will return the performance data to the DTX-MULTI 12 as it is being recorded, and the instrument's internal tone generator will sound as if it is being played directly (on Channel 1).

NOTE

- For details on how to turn on MIDI Thru, refer to the manual that came with your DAW application.
- If local control on the DTX-MULTI 12 and MIDI Thru within your DAW application are both turned off, no performance data will be sent to the internal tone generator, either directly or indirectly. As a result, no sound will be produced.

■ **Playing the DTX-MULTI 12 using MIDI Data from a DAW Application**

As described below, you can setup the DTX-MULTI 12 to operate as a multi-timbral tone generator for your DAW application. In this way, you can easily integrate the instrument's high-quality MIDI tone generator into your music-production setup. For details on how to connect the DTX-MULTI 12 to your computer, see page 13.

- 1 Set each of the tracks within your DAW application to output their MIDI data to the DTX-MULTI 12.
- 2 Play MIDI performance data using the DAW application.

Setting up Cubase Remote Control

Using a special feature, the DTX-MULTI 12 can operate as a remote controller for Cubase. For example, you can operate the Cubase transport, turn its metronome on or off, and control various other functions from the instrument's front panel, significantly increasing the efficiency of your music production workflow.

■ Computer settings

When setting up Cubase remote control for the first time, complete the following steps to configure your computer correctly.

1 Download the latest version of the DTX-MULTI 12 Extension from the following web page.

Save the compressed file in a convenient location and then expand it.

<http://dtxdrums.yamaha.com>

NOTE

- Ensure that the latest USB MIDI driver is installed on your computer (see page 13).
- Information on system requirements is also provided on the above web page.
- The DTX-MULTI 12 Extension may be revised and updated without prior notice. Before installing, visit the above web page to confirm the latest related information and ensure that you have the most up-to-date version.

2 Execute the expanded DTX-MULTI 12 Extension to carry out the required installation procedure. For more details, refer to the owner's manual included in the downloaded package.

■ DTX-MULTI 12 settings

Whenever the Cubase Remote function is to be used, the following steps must be completed on the DTX-MULTI 12.

1 Within the UTILITY setting area, navigate to the MIDI In/Out page (UTIL6-9) and set MIDI IN/OUT to "USB".

```
UTIL6-9  <MIDI>
MIDI IN/OUT=USB
```

2 Ensure that the DTX-MULTI 12 is connected to your computer in the correct manner, and then launch Cubase.

For more details regarding connection, see page 13.

3 Hold down the [SHIFT] button and press the [MIDI] button.

The message "Cubase Remote" will be displayed to confirm that the function has been activated.

```
<<  Cubase  >>
<<  Remote  >>
```

NOTE

- When Cubase Remote mode has been activated, those front-panel buttons that can be used will light up.

4 To deactivate Cubase Remote mode, again hold down the [SHIFT] button and press the [MIDI] button.

■ Button Functions in Cubase Remote Mode

NOTE

- For more details regarding the operation of Cubase Remote mode, refer to the owner's manual included in the downloaded package.

Button	Operation
[SHIFT] + [MIDI]	Turns the Cubase Remote function on and off.
[KIT]	Opens the VSTi window.
[PTN]	Starts and stops playback.
[SHIFT] + [PTN]	Starts recording.
[-/DEC], [+ /INC]	Increases or decreases a preset by 1.
[<]	Rewinds the transport (REW).
[>]	Fast forwards the transport (FF).
[VA]	Returns the transport to the start of the song (TOP).
	Turns the click track on and off.

Producing Sounds with the Pads

In order that you can start having fun with your DTX-MULTI 12 as soon as possible, this section will begin by explaining the basic way in which the pads can be played using drum sticks (sold separately), and following that, will show how to select various kits (i.e., sets of pad sounds).

Pad Names

As shown below, numbers 1 through 12 are assigned to the built-in pads. These numbers are also shown at the corresponding positions within the Pad Indicator, and they will light up when the associated pad is struck.

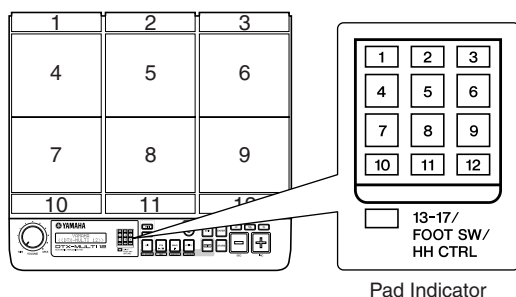

CAUTION

- Do not place your fingers into the gaps between Pads 1 to 3 and the instrument's plastic body. If this precaution is not observed, your fingers may be injured as a result of crushing or squeezing.

Striking the Pads

When playing Pads 4 to 9 (i.e., the main pads), aim to strike the center of the pad with the tip of the drum stick.

● Playing Pads 4 to 9



Meanwhile, when playing Pads 1 to 3 and Pads 10 to 12 (i.e., the rim pads), aim to strike the center of the pad with the shoulder of the drum stick.

● Playing Pads 1 to 3 and Pads 10 to 12



You can also adjust the sensitivity of the pads to allow them to be played by hand (see page 19).

**NOTE**

- Drum and other individual instrument sounds known collectively as preset voices and rhythmic or musical phrases known as patterns can be assigned to each of the pads. Whenever you strike a pad to which a pattern has been assigned, the pattern will either be played through just once (one-shot) or repeated (loop), and the corresponding lamp within the Pad Indicator will light up. If a pad playing a looped pattern is struck again, the pattern will stop playing and the lamp will go out.
- If looping patterns are assigned to multiple pads and you lose track of which ones are actually being played, you can silence all sound output by holding down the [SHIFT] button and pressing the [EXIT] button.
- If a pad is struck too lightly or very close to an edge or corner, the corresponding lamp in the Pad Indicator may not turn on.

Muting

Muting is the action of placing a hand on a struck percussion instrument in order to silence it, and the DTX-MULTI 12 pads support this playing technique. In addition, when multiple sounds have been assigned to a pad, you can use also muting to switch between these sounds for more expressive performances.

NOTE

- For details on how to switch sounds by muting, see page 51.

Selecting a Preset Kit

The term “kit” is used to refer to a collection of sounds (i.e., preset voices, waves, and patterns) produced when you strike each of the pads, and the DTX-MULTI 12 comes complete with an impressive range of specially-prepared preset kits. Using the procedure outlined below, select various kits and enjoy some of the stunning sounds that your instrument can produce.

NOTE

- The screen displays shown in this Owner's Manual are for instructional purposes only, and they may appear somewhat different from those on your DTX-MULTI 12.

1

Press the [KIT] button to open the Select Kit page.

The [KIT] button will light up.



```
KIT1
P001:PercsMaster
```

2

Use the [-/DEC] and [+ /INC] buttons to select a new drum kit.

Try playing the each of the pads from various different types of kit.

NOTE

- A number of the Preset kits have been specially setup for playing by hand. When you select one of them, a hand icon will be displayed on-screen as shown below.

- **Kit suitable for playing by hand**

```
KIT1      🖐️
P001:PercsMaster
```

- Kits having a number preceded by the letter “U” are User kits (i.e., user-defined kits). With these kits, you can create and save your own collections of preset voices, patterns, and waves.

- **User-defined kit**

```
KIT1
U001:User Kit
```

Starts with “U”

Assigning Preset Voices to Pads

In the following simple example, we will create a User kit by replacing one of the sounds assigned to the pads in a Preset kit. Specifically, we will assign a voice to Pad 4 from the selected kit, and we will then save the resultant kit to the empty User kit U001.

- 1 Press the [KIT] button to open the Select Kit page.

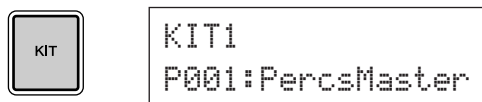

- 2 Use the [-/DEC] and [+ /INC] buttons to select a kit to work with.

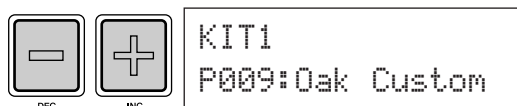

- 3 Press the [VOICE] button to open the Select Voice page.

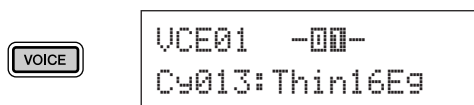

- 4 Strike Pad 4 to select it and to change the displayed pad number to **04**.

Alternatively, you can move the flashing cursor to the pad number, and then change it from **01** to **04** using the [-/DEC] and [+ /INC] buttons.

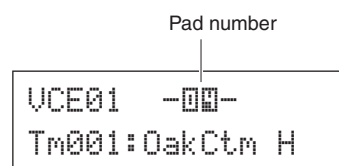

- 5 Select the voice you want to assign to Pad 4.

Move the flashing cursor to the leftmost parameter from the lower row of text, and using the [-/DEC] and [+ /INC] buttons, select the voice category and voice number of the voice you wish to assign.

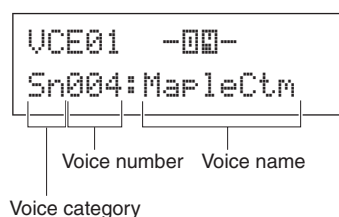

Voice Categories

Similar voices are grouped together in voice categories. In addition to melodic instruments such as timpani and marimba, you can also select voice categories containing Preset patterns, User patterns, and waves. For more information, refer to the Data List booklet.

6 Press the [STORE] button and store the edited kit as a User kit.

As shown here, select the empty User kit U001, using the [-/DEC] and [+/INC] buttons if necessary, and then press the [ENTER] button.

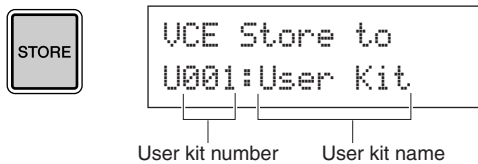

NOTE

- The [STORE] button will light up whenever settings have been changed but not yet stored in the DTX-MULTI 12's internal memory. The button will, therefore, go out when the modified settings are stored.

7 When asked to confirm that you want to store the kit, press the [ENTER] button to proceed.

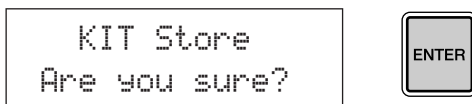

CAUTION

- The message "Please keep power on..." will be displayed while data is being stored. It is very important that the DTX-MULTI 12 is not turned off until this message disappears. If the instrument were to be turned off at this time, data for all User kits could be permanently lost.

Please keep
POWER ON...

8 With User pad U001 selected, strike Pad 4 to hear the voice that you assigned.

Layers

Using the Layer function, you can assign a number of different voices to a single pad or external controller. Up to four layers (A to D) to be setup per pad, meaning that each pad can play as many as four different voices. Furthermore, a number of different playback modes can be employed for voices assigned to layers. For example, these voices can be triggered simultaneously, a different one can be played each time the pad is struck, or they can alternate between on and off upon successive hits. Details on layers can be found on page 32.

Playing by hand

The DTX-MULTI 12 features a number of different preset kits suitable for hand percussion – that is, for playing with hands instead of drum sticks. As described below, furthermore, you can use a trigger setup at any time to adjust the sensitivity of the pads to suit playing by hand.

Setting pad sensitivity for playing by hand

- Hold down the [SHIFT] button and press the [UTILITY] button to access the Trigger setting area. The Select Trigger Setup page will be displayed.

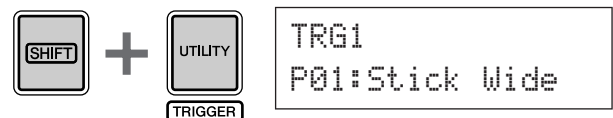

- Use the [-/DEC] and [+/INC] buttons to select the "P04: Hand" or "P05: Finger" trigger setup.

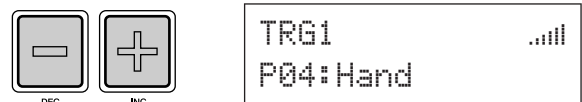

NOTE

- Whenever you select a hand-percussion preset kit, the pad sensitivity (i.e., the trigger setup) will automatically change to suit playing by hand.
- Very high levels of pad sensitivity are more likely to result in a phenomenon known as crosstalk, where pads other than the one struck trigger sounds due to vibration or interference between pads.
- For details on how to configure trigger setups in the Trigger setting area, see page 99.

Listening to Patterns

Your DTX-MULTI 12 has been pre-loaded with a rich variety of melodic and rhythmic phrases in the form of Preset patterns. The first three Preset patterns (P001 to P003) have been specially setup to demonstrate the rich spectrum of sounds that your DTX-MULTI 12 can produce. Patterns numbered P004 and higher can be freely assigned to pads for use in your own User drum kits.

Listening to Demo Patterns

- 1 Press the [PTN] button to open the Select Pattern page.**

The [PTN] button will light up. Demo patterns are numbered P001 to P003.



```
PTN1  J=120 4/4
JP001:Demo 01
```

- 2 Press the [PTN] button once again to start playback of a demo pattern.**

The [PTN] button will flash while the demo pattern is being played, and the name of the pattern will be displayed inside "<<" and ">>" characters on the upper row of text. Furthermore, the lower row of text will shown the name of the kit being used for playback of the demo pattern.



```
<<Demo 01>>
P039:Orchestra
```

- 3 To stop the demo pattern, press any button other than [SHIFT].**

Listening to Preset Patterns

- 1 Press the [PTN] button to open the Select Pattern page.**

- 2 Select the Preset pattern you want to listen to using the [-/DEC] and [+/INC] buttons.**

Select a Preset pattern numbered P004 or higher.

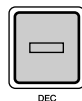

```
PTN1  J=120 4/4
JP004:80s Electro
```

- 3 Press the [PTN] button once again to start playback of the selected Preset pattern.**

The [PTN] button will flash while the Preset pattern is being played.



- 4 To stop the pattern, press the [PTN] button on the Select Pattern page (PTN1).**

NOTE

- If you wish to assign a Preset pattern to a pad, follow the procedure described on page 18, and at Step 5, select the Preset pattern instead of a preset voice.

Making Your Own Patterns

Using the DTX-MULTI 12, you can also create User patterns by recording your own performances. And in the same way as Preset patterns, these User patterns can then be freely assigned to pads and played back.

Recording Your Performance as a Pattern

Following the steps below, let's create a User pattern by recording a performance and then assign that pattern to Pad 6.

- 1 Press the [PTN] button to access the Pattern setting area, and select an empty User pattern using the [-/DEC] and [+ /INC] buttons.

Empty User patterns are named "Empty Ptn".



```
PTN1  J=120 4/4
JU003:Empty Ptn
```

Pattern name

CAUTION

- If you select a User pattern already containing data, your performance will be added to that data as a result of recording. If you want to avoid this, be sure to select an empty User pattern for recording.

NOTE

- If you select a User pattern already containing data for recording, you can add additional performance data to that pattern as you record.
- Two existing patterns can be merged to create a new User pattern (see page 79).

- 2 Press the [KIT] button to open the Select Kit page, and using the [-/DEC] and [+ /INC] buttons, select the drum kit you want to use for recording your pattern.



```
KIT1
P001:PercsMaster
```

- 3 Hold down the [SHIFT] button and press the [PTN] button to activate Record Mode. The [PTN] button will turn red.



```
REC  J=120 4/4
Meas=004 Q=J ->
```

NOTE

- If a Preset pattern is selected when you activate Record Mode, your performance will be recorded to an empty User pattern.

- 4 Set the required recording conditions.

On the Record Mode screen (REC), you can set the tempo and time signature of the click track to be played when recording, the length of the pattern in measures (or bars), and a number of other important parameters. Move the flashing cursor to the required parameter using the [<], [VΛ], and [>] buttons, and change the setting using the [-/DEC] and [+ /INC] buttons.

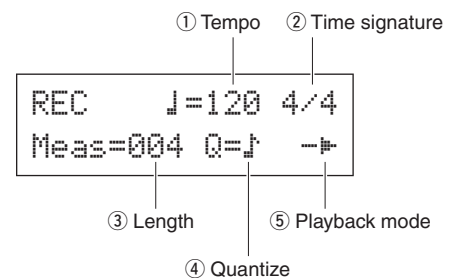

- ① **Tempo:** The speed of the pattern in beats per second.
- ② **Time signature:** The time signature of the pattern to be recorded.
- ③ **Length:** The length of the pattern in measures.
- ④ **Quantize:** The precision of timing correction for the recorded pattern.
- ⑤ **Playback mode:** The type of pattern to be recorded – i.e., one-shot or loop.

5

Press the [PTN] button to start recording.

The DTX-MULTI 12 will count you in over two measures. Then, play the pattern you want to record in time with the click track.

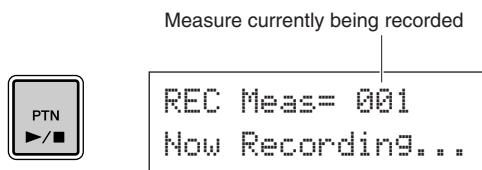

CAUTION

- Turning off the DTX-MULTI 12 while recording can result in data for all User patterns being lost and must, therefore, be avoided.

6

Recording will end automatically after the number of measures set as the pattern length in Step 4 above.

The message "Please keep power on..." will be displayed for a short period of time as data is being stored.

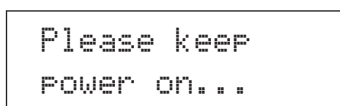

CAUTION

- Turning off the DTX-MULTI 12 while the message "Please keep power on..." is being displayed can result in all User-pattern data being lost and must, therefore, be avoided.

NOTE

- Recording can be stopped at any time by pressing the [PTN] button. All performance data recorded up to that point will be stored.
- If looped playback was selected in Step 4 above, recording can be ended by pressing the [PTN] button.

7

When the Pad Assign page is displayed, strike Pad 6 to display pad number 00, and then press the [ENTER] button.

Alternatively, you can use the [-/DEC] and [+/INC] buttons to select 00 on this page.

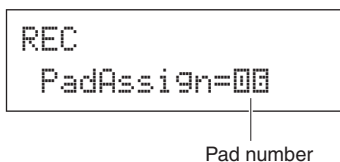

NOTE

- If you set PadAssign to "off", the recorded pattern will not be assigned to any pad.
- Although you can freely assign the recorded pattern to a pad at any time, it is best to use a pad from the drum kit selected in Step 1 above. If you assign it to a pad from another kit, the pattern may not play as recorded.

8

Press the [KIT] button to access the KIT setting area.

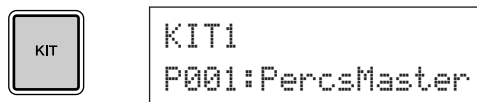

9

Press the [STORE] button and store the current kit and its new pattern assignment as a User kit.

As shown here, select an empty User kit using the [-/DEC] and [+/INC] buttons, and then press the [ENTER] button.

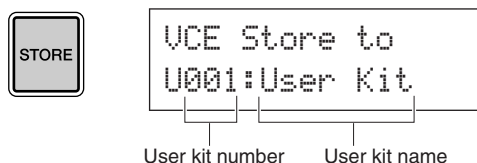

10

When asked to confirm that you want to store the kit, press the [ENTER] button to proceed.

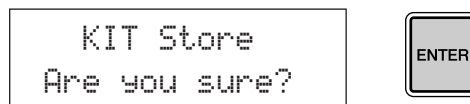

CAUTION

- The message "Please keep power on..." will be displayed while data is being stored. It is very important that the DTX-MULTI 12 is not turned off until this message disappears. If the instrument were to be turned off at this time, data for all User kits could be permanently lost.

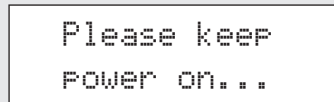

11

With the stored drum kit selected, strike Pad 6 to hear the pattern that you assigned.



NOTE

- Up to 50 User patterns can be recorded on your DTX-MULTI 12. If an attempt is made to record more than this number, the message "Seq data is not empty" will be displayed and the recording process will end. In such a case, delete unneeded User patterns (see page 79) and begin recording again.

Saving Your Data on a USB Memory Device

Data that you have made, such as User kits and User patterns, can be conveniently saved as combined files on a USB memory device. In the following example, we will create a single file containing all of the data created or modified in the various DTX-MULTI 12 setting areas on a such a device.

1 Plug a USB memory device into the USB TO DEVICE port on the side panel.

NOTE

- For more details regarding USB memory devices, see the section Connecting a USB Memory Device on page 11.

2 Press the [UTILITY] button to access the UTILITY setting area, use the [<]/[>] buttons to navigate to the FILE section (UTIL7), and then press the [ENTER] button.

```
UTIL7
      FILE
```

3 Navigate to the Save File page (UTIL7-1), using the [<]/[>] buttons if necessary, and then press the [ENTER] button.

```
UTIL7-1
      Save File
```

4 Set Type to "All", using the [-/DEC] and [+ /INC] buttons if necessary.

When you have made this setting, press the [ENTER] button.

```
UTIL7-1-1
Type=All
```

NOTE

- For details on saving data with a Type setting other than "All", see page 93.

5 Enter a name for the file to be saved.

For more details on how to input characters and the types of character that can be used for file names, see page 47.

```
UTIL7-1-2
Name[          ]
```

NOTE

- File names can be up to eight characters in length.

6 When you have entered the required name, press the [ENTER] button.

You will be asked to confirm that you want to save the file, and the [ENTER] button will flash on and off.

```
Save File
Are you sure?
```

7

To proceed, press the [ENTER] button one more time.

If a file with the same name already exists on the USB memory device, you will be asked to confirm whether you want to overwrite it. If that file is no longer needed and can be overwritten, press the [ENTER] button. Alternatively, if the older file contains important data, press the [EXIT] button to return to the Name page and repeat the procedure from Step 5 above using a different file name.

The message “Now saving... [EXIT] to cancel” will be displayed while your data is being saved. The message “Completed.” will then be displayed when the data has been saved, and the display will return to the Save File page (UTIL7-1) from Step 4 above.

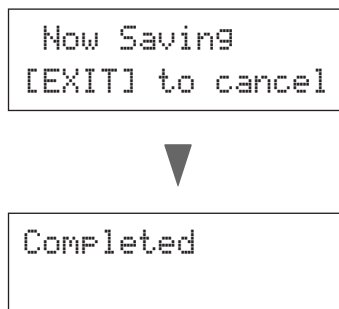

CAUTION

- Do not unplug the USB memory device from the USB TO DEVICE port or turn off either the USB memory device or the DTX-MULTI 12 while data is being loaded or saved. Failure to observe this precaution can lead to the USB memory device or the DTX-MULTI 12 being permanently damaged.

CAUTION

- Be sure to always unplug USB memory devices from the DTX-MULTI 12 before you start to play. If you were to accidentally strike a memory device with a drum stick while playing, it could be permanently damaged and all data saved on it could be lost.

Importing Audio Files

WAV and AIFF audio files from your computer and other media can be imported into your DTX-MULTI 12 via USB memory devices. Referred to as “waves”, these voices can then be assigned to pads and played in the same way as any other preset voice.

NOTE

- Only 16-bit audio files can be used with your DTX-MULTI 12. If the audio files you wish to use have been recorded with a different bit depth, please convert them to 16-bit in advance using, for example, the bundled DAW software. For details regarding the conversion method, refer to the DAW software’s manual.
- Your DTX-MULTI 12 can import audio files of up to approximately 23 seconds in length (in the case of 44.1-kHz, 16-bit audio).
- It is important to note that even when the above conditions are satisfied, certain other factors may make audio files incompatible with the DTX-MULTI 12.

1 Using a computer, place the WAV or AIFF file(s) for importing at the root directory of a USB memory device.

2 Unplug the USB memory device from the computer and plug it into the instrument via the USB TO DEVICE port on the side panel.

3 Press the [KIT] button to open the Select Kit page and then select the drum kit to which the imported wave(s) will be assigned.



```
KIT1
U001:User Kit
```

4 Hold down the [SHIFT] button and press the [WAVE] button to open the Import page.



```
IMPORT
Surdo.WAV
```

5 Select the audio file you want to import using the [-/DEC] and [+/INC] buttons.

6 When you have made your selection, press the [ENTER] button to import the file.

```
Now Importing...
[EXIT] to cancel
```

CAUTION

- Do not unplug the USB memory device from the USB TO DEVICE port or turn off either the USB memory device or the DTX-MULTI 12 while data is being loaded. Failure to observe this precaution can lead to the USB memory device or the DTX-MULTI 12 being permanently damaged.
- If the selected file is not 16-bit, the error message “Illegal wave data.” will be displayed and the import process will be halted. In such a case, please convert the file to 16-bit using, for example, the bundled DAW software and then repeat the import process.

7 Once the audio file has been imported, the Pad Assign page will open. Select the pad to which the imported wave is to be assigned and press the [ENTER] button.

```
IMPORT
PadAssign=00
```

CAUTION

- If a voice has already been assigned to the selected pad, it will be deleted and replaced with the imported wave.

NOTE

- If you set PadAssign to “off”, the imported wave will not be assigned to any pad.
- Imported AIF and WAV audio files are stored as waves, or in other words, as one of the three types of DTX-MULTI 12 voices. As such, they can be freely assigned to pads at any time using the VOICE setting area (see page 56).

8 Press the [KIT] button to return to the KIT setting area.

9 Press the [STORE] button and store the current kit and its new wave assignment as a User kit.

As shown here, select an empty User kit using the [-/DEC] and [+ /INC] buttons, and then press the [ENTER] button.

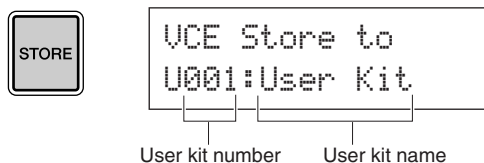

10 When asked to confirm that you want to store the kit, press the [ENTER] button to proceed.

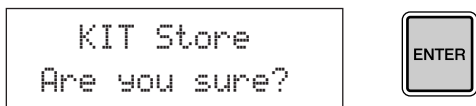

⚠ CAUTION

- The message "Please keep power on..." will be displayed while data is being stored. It is very important that the DTX-MULTI 12 is not turned off until this message disappears. If the instrument were to be turned off at this time, data for all User kits could be permanently lost.

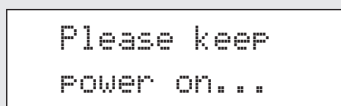

11 To hear the imported wave, strike the pad to which it was assigned.



Internal Design

In this reference section, you will find a description of what takes place within the DTX-MULTI 12 between striking of a pad and the output of a sound from speakers. Understanding how signals flow and are processed internally will allow you to utilize the powerful functions of this versatile instrument to their maximum potential.

Functional Blocks

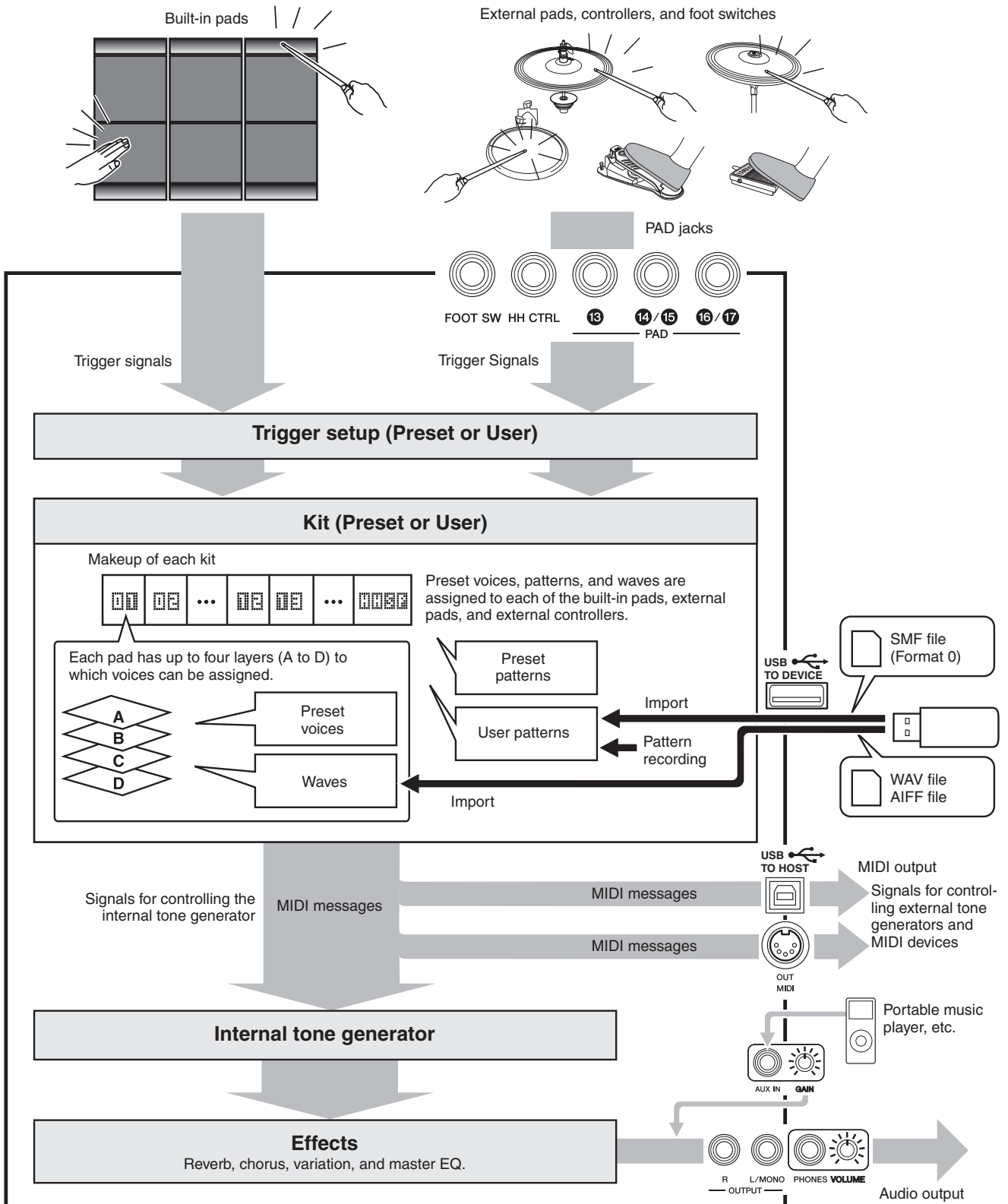

Pads & Trigger Signals

The DTX-MULTI 12 is played by striking any of the twelve built-in pads and by striking and operating external pads, foot switches, or other controllers connected via the PAD jacks (13 to 17), the HI-HAT CONTROL jack, and the FOOT SW jack. Whenever you perform this type of action, a trigger signal containing various items of performance data, such as the strength with which the pad was struck, will be produced. These trigger signals are delivered to a tone generator, which outputs the appropriate sound in response.

■ Built-in Pads (1 to 12)

As shown below, each of the DTX-MULTI 12's built-in pads is assigned a unique number between 1 and 12. On the various parameter-setting pages used to configure the instrument, these numbers are presented in the format to as a means of identifying individual pads. Although Pads 4 to 9 (main pads) and Pads 1 to 3 and 10 to 12 (rims) are shaped differently, they all function in exactly the same way. Whenever they are struck, the assigned voices, waves, or patterns will be played.

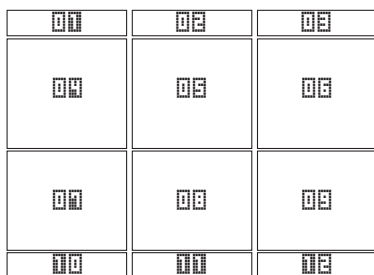

■ PAD Jacks (13 to 17)

The trigger-input jacks provided on the rear panel are used to connect optional pads. Furthermore, the PAD 13 jack can be used to connect a three-zone pad, which produces three different types of trigger signal based on the position at which it is struck. The DTX-MULTI 12 treats these zones as three individual pads, identifying them on-screen as , , and . For example, the three trigger signals output by a TP65S Three Zone Drum Pad are identified as shown below.

Example: TP65S

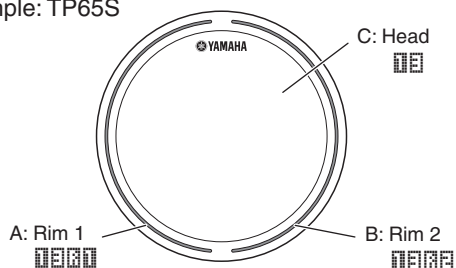

- A: When a trigger signal from rim 1 is received, the voices assigned to Pad are played.
- B: When a trigger signal from rim 2 is received, the voices assigned to Pad are played.
- C: When a trigger signal from the head is received, the voices assigned to Pad are played.

Although each features just one connector, the PAD 14/15 and PAD 16/17 jacks can be used to connect the mono outputs from a pair of pads. In this way, each of these jacks can handle two different trigger signals. Within the display, the numbers , , , and are used to identify the corresponding pads.

Example:

Connecting a TP65 and a PCY65 via the PAD 14/15 jack

When a trigger signal produced by striking the TP65 Single Zone Drum Pad is received, the voices assigned to Pad are played.

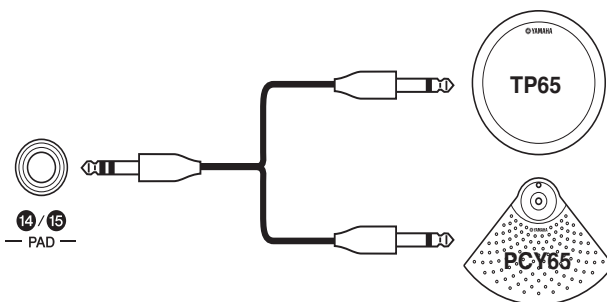

When a trigger signal produced by striking the PCY65 Single Zone Cymbal Pad is received, the voices assigned to Pad are played.

■ HI-HAT CONTROL Jack

The Hi-hat Control jack is used to connect an optional RHH135 Two Zone Hi-Hat Pad (via its HH CTRL jack) or an HH65 Hi-hat Controller (via its OUTPUT jack). As you play the pad or controller, the DTX-MULTI 12 receives and recognizes trigger signals for both hi-hat close and hi-hat splash*. Within the display, these signals are identified as and , respectively.

* Hi-hat splash refers to the technique of producing sound by rapidly depressing and releasing the hi-hat pedal.

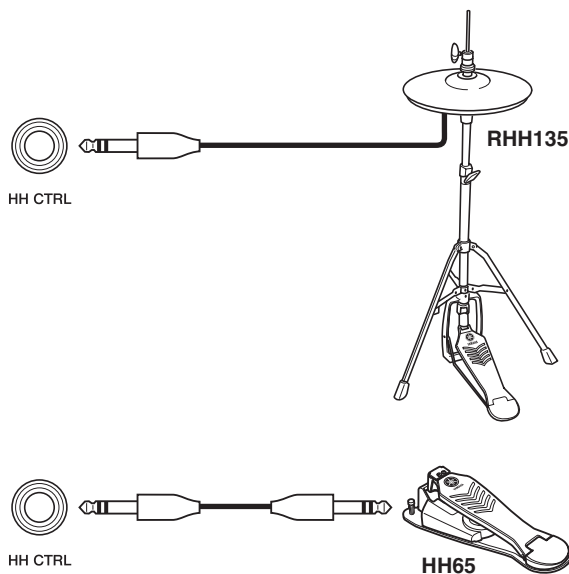

NOTE

- Parameters related to hi-hats can be set on the various pages from the UTILITY setting area's HI-HAT section (UTIL5). (See page 89.)

■ FOOT SW Jack

The Foot Switch jack is used to connect an optional hi-hat controller (FC4 or FC5, etc.), hi-hat controller (HH65, etc.), or foot controller (FC7) to the DTX-MULTI 12.

Within the instrument's display, a signal input via this jack is identified as .

Once you have told the DTX-MULTI 12 which type of controller or foot switch is connected, you can then select from a range of useful functions to assign to it. A number of typical examples are described below.

NOTE

- Be sure to always turn off the DTX-MULTI 12 before connecting a controller or foot switch. If you do not follow this precaution, the controller or foot switch may not function correctly.



● Using an HH65 as a bass drum pedal

[Function]

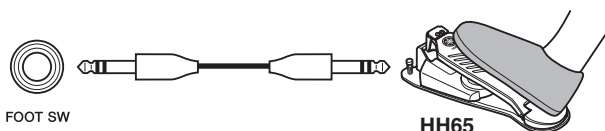
With parameters configured as described below, an HH65 Hi-hat Controller can be used to play bass-drum voices and the like. As with acoustic drums, furthermore, the tone of the sound produced can be influenced by how fast or slow you depress the controller. In addition, drum sounds can be produced without the vibration and mechanical noise typical of acoustic bass-drum pedals.



[Setup]

- With the DTX-MULTI 12 turned off, connect the HH65 Hi-hat Controller via the FOOT SW jack.
- Turn on the DTX-MULTI 12.
- On the Foot Switch Input page (UTIL4-2), set FootSwInSel to "HH65". (See page 89.)
- On the Pad Function page (UTIL4-1), select  and then set Func to "off". (See page 88.)
- Open the Select Voice page (VCE1) and choose a voice, such as a bass drum, to be assigned to . (See page 56.)

● Playing sounds using an FC4 or FC5

[Function]

With parameters configured as described below, you can play sounds by operating an FC4 or FC5 Foot Switch. Trigger signals generated in this way have a fixed velocity, and therefore, they are ideal for playing effect sounds, patterns, and waves.



[Setup]

- With the DTX-MULTI 12 turned off, connect the FC4 or FC5 Foot Switch via the FOOT SW jack.
- Turn on the DTX-MULTI 12.
- On the Foot Switch Input page (UTIL4-2), set FootSwInSel to "ftSw". (See page 89.)
- On the Pad Function page (UTIL4-1), select  and then set Func to "off". (See page 88.)

- Open the Select Voice page (VCE1) and choose a preset voice, pattern, or wave to be assigned to . (See page 56.)

● Changing kits or patterns using an FC4 or FC5

[Function]

With parameters configured as described below, you can use an FC4 or FC5 Foot Switch to change a range of different settings. For example, you could operate a foot switch to select the next kit or pattern, to increase or decrease the tempo by 1, to tap the tempo, or to turn the click-track on or off. Furthermore, you can also set a MIDI Control Change message number and value to be sent when the foot switch is depressed.



[Setup]

- With the DTX-MULTI 12 turned off, connect the FC4 or FC5 Foot Switch via the FOOT SW jack.
- Turn on the DTX-MULTI 12.
- On the Foot Switch Input page (UTIL4-2), set FootSwInSel to "ftSw". (See page 89.)
- On the Pad Function page (UTIL4-1), select  and then set Func to the function you want to control using the foot switch. (See page 88.)

● Adjusting volume (or other MIDI Control Change values) using an FC7

[Function]

With parameters configured as described below, you can adjust volume and many other MIDI Control Change values by changing the pedal angle of an FC7 Foot Controller (in order to send MIDI Control Change messages). The FC7 retains its current pedal angle after you remove your foot, and therefore, it is ideal for making minute changes to the controlled parameter.



[Setup]

- With the DTX-MULTI 12 turned off, connect the FC7 Foot Controller via the FOOT SW jack.
- Turn on the DTX-MULTI 12.
- On the Foot Switch Input page (UTIL4-2), set FootSwInSel to "FC7". (See page 89.)
- On the Pad Function page (UTIL4-1), select  and then set Func to the MIDI Control Change message ("CC01" to "CC95") that you want to control. (See page 88.)

● Adjusting volume and other parameters using an HH65

[Function]

In the same way as with an FC7 Foot Controller, you can adjust volume and a wide range of MIDI Control Change values by adjusting the degree by which an HH65 Hi-hat Controller is operated.

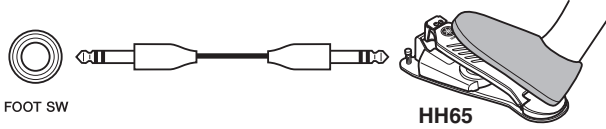

[Setup]

- With the DTX-MULTI 12 turned off, connect the HH65 Hi-hat Controller via the FOOT SW jack.
- Turn on the DTX-MULTI 12.
- On the Foot Switch Input page (UTIL4-2), set FootSwInSel to "HH65". (See page 89.)
- On the Pad Function page (UTIL4-1), select and then set Func to the MIDI Control Change message ("CC01" to "CC95") that you want to control. (See page 88.)

■ Using Acoustic Drums to Produce Trigger Signals

Optional drum triggers, such as the DT10 or DT20, can be used to convert performances on acoustic drums into trigger signals and to input these signals into the instrument. You can even apply drum triggers to training pads in order to produce trigger signals.

■ Trigger Setups

Settings for all of the parameters associated with pad sensitivity are collectively referred to as a "trigger setup". In addition to the actual sensitivity of the pad when it is struck, a trigger setup can also include parameter settings intended to prevent a pair of trigger signals being produced in response to a single strike (i.e., double triggering) and unwanted trigger signals being produced by pads other than the one that was struck (i.e., crosstalk). The DTX-MULTI 12 supports many different playing styles using sticks and hands, and by selecting the most appropriate trigger setup for the style being used, you can ensure that trigger signals will be correctly processed. Trigger setups can also be adjusted in order to ensure that trigger signals from external pads and controllers are processed in an ideal manner.

Your DTX-MULTI 12 comes pre-loaded with five Preset trigger setups suitable for many different needs, and you can also create up to ten unique User trigger setups to suit your own individual requirements.

■ Using Optional Pads & Drum Triggers with the PAD Jacks

Whenever you are using separately-sold pads and/or drum triggers, the types of trigger signal handled will depend on which of the PAD jacks is used for connection. The following table shows how optional pads and drum triggers will operate when connected via the various PAD jacks on the rear panel.

PAD 13: Suitable for use with two-zone and three-zone pads. Not suitable for pad controllers.

PAD 14/15, PAD 16/17: Not suitable for two-zone pads, three-zone pads, or pad controllers.

Model	Product name	Input (PAD jacks)	
		PAD 13	PAD 14/15 PAD 16/17
TP65	Drum Pad	C	C
TP65S	Drum Pad	A	C
TP100	Drum Pad	A	C
TP120SD	Snare Pad	B	C
RHH130	Hi-hat Pad	B	C
RHH135	Hi-hat Pad	B	C
PCY65	Cymbal Pad	C	C
PCY65S	Cymbal Pad	B	C
PCY130	Cymbal Pad	C	C
PCY130S	Cymbal Pad	B	C
PCY130SC	Cymbal Pad	A	C
PCY135	Cymbal Pad	A	C
PCY150S	Cymbal Pad	A	C
PCY155	Cymbal Pad	A	C
KP65	Kick Pad	C	C
KP125	Kick Pad	C	C
DT10	Drum Trigger	C	C
DT20	Drum Trigger	C	C

A: Operates as a three-zone pad.

If using a compatible product from the TP series, voices assigned to each of the two rim sections and the head section can be played. If using a compatible product from the PCY series, voices assigned to each of the bow, edge, and cup sections can be played.

B: Operates as a two-zone pad.

If using a compatible product from the RHH series, voices assigned to each of the bow and edge sections can be played. If using a compatible product from the PCY series, voices assigned to each of the bow and edge sections can be played.

C: Operates as a monoaural pad.

NOTE

- For the most up-to-date information on support for optional pads and drum triggers, visit the following web page.
<http://dtxdrums.yamaha.com>

Sounds Produced Using the Pads

Whenever the internal tone generator receives a trigger signal produced by striking a pad or by operating a controller or foot switch, it will play a voice assigned to that pad, controller, or foot switch. As described below, three different types of voice are available for assigning – namely, preset voices, patterns, and waves.

- **Preset voices**
Drum sounds such as snares, bass drums, and cymbals; percussion sounds; and pitched-instrument sounds such as piano, xylophone, and guitar.
- **Patterns**
One-shot or looped phrases containing performance data for a range of different instruments.
- **Waves**
Audio files imported into the DTX-MULTI 12 from a variety of sources.

To assign a voice to a pad, controller, or foot switch, access the VOICE setting area's Select Voice page (VCE1) by pressing the [VOICE] button (and if necessary, the [<] button). On this page, voices are categorized by instrument type (in the case of preset voices), as patterns, or as waves. While preset voices, patterns, and waves can all be assigned to pads in the same way, it is important to remember that each voice type plays in a different way and is configured using different parameters.

■ Preset Voices

As an electronic percussion instrument played by striking pads, the DTX-MULTI 12 comes preloaded with a vast library of drum sounds, such as snares, bass drums, and cymbals, together with a broad spectrum of percussion-instrument sounds. Also included are many pitched instruments, such as piano, xylophone, and guitar. The term “preset voices” is used to refer to these built-in drum and instrument sounds.

Drum and percussion voices from this preset-voice collection are not rooted at one specific pitch; instead, you can intuitively adjust their tuning in order to match the sounds of other instruments. Meanwhile, pitched-instrument voices such as piano and guitar can be assigned to pads with a specific pitch setting, thus allowing you to play several different notes together to produce chords, or with voices at different semitones assigned to the twelve pads, to freely play melodic parts. With the timing and strength of your playing reflected in the sound produced by preset voices, you can perform with practically the same level of expressiveness as afforded by acoustic instruments.

■ Patterns

The DTX-MULTI 12 can also play rhythmic or melodic phrases known as “patterns”. Capable of reproducing the sound of performances on many different instruments, each pattern can be up to several measures in length. In the same way as snare sounds are produced by striking a pad to which a snare voice has been assigned, you can start and stop the playback of a pattern by striking the pad to which it is assigned. In effect, pads with pattern assignments operate as start/stop switches whenever struck (regardless of how hard or soft they are actually struck). Your DTX-MULTI 12 comes pre-loaded with 128 Preset patterns (including 3 demo patterns) containing performance data from a host of different instrument genres, and by assigning these freely to pads, you can easily create your own unique kits. For even more flexibility, you can also record your own performances and even import standard MIDI files (Format 0) to create up to 50 additional User patterns.

■ Waves

The DTX-MULTI 12 is fully equipped to playback audio files that can be created, edited, and played on computers. Commonly called “samples” or “sample data”, these files contain short portions of sound, and once imported into the DTX-MULTI 12, they are referred to as “waves”. Either WAV or AIFF type audio files can be imported into the instrument's internal wave memory and assigned to pads in much the same way as preset voices and patterns. You can also edit imported waves.

As audio files imported into the instrument's wave memory are assigned to pads as a single voice much like preset voices and patterns, the term “wave data” is used within this manual in the same way as “preset voice data” or “pattern data”. In contrast, the term “wave file” is used to refer to data that has not yet been imported and is handled in the form of a file on a computer, sampler, or USB memory device.

Kit Makeup

The term “kit” is used to refer to a collection of preset voices, patterns, and waves assigned to each of the instrument’s built-in pads (1 to 12) and to any external pads, foot switches, or controllers connected via the PAD jacks (13 to 17), the FOOT SW jack, and the HI-HAT CONTROL jack. For added convenience, the instrument comes pre-loaded with 30 different Preset kits. You are, however, free to make your own unique kits in whatever way you see fit, and up to 200 of these User kits can also be stored internally.

■ Kits & Voices

Within the DTX-MULTI 12, voice data is grouped and stored in kit units. In other words, each kit contains the voice-related information for all of its pad and controller assignments. Whenever a User kit is created by editing voices, the voices themselves are not stored within the kit; instead, the settings for all associated parameters – such as tuning, stereo pan, attack time, release time, effects, etc. – are stored. As you would expect, each of the pads can have different parameter settings. Therefore, even when the Select Voice page shows the same voice assigned to two or more pads, the sounds produced by each will not necessarily be the same.

■ Voice Layers

Using the DTX-MULTI 12’s Layer function, you can assign a number of different voices to a single pad or external controller. Specifically, this instrument allows up to four layers (A to D) to be setup per pad, meaning that each pad can play as many as four different voices. These layered voices can also be triggered in a number of different ways – for example, they will all play together in Stack mode, a different one will be played for each strike in Alternate mode, and they can be sustained and turned off on each successive strike in Hold mode. In order that the Layer function may be put to use, the pad in question must first be setup to send multiple MIDI messages whenever struck. Then, voices are assigned to each of the layers, and a layer playing mode is specified for the pad. For more details, refer to the section Specifying MIDI note numbers and assigning voices to each on page 34.

Arrangement of Voice Layers

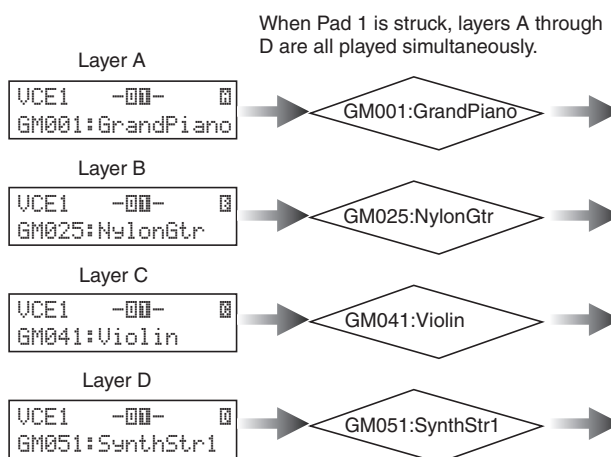

■ Information Contained in Kits

Three different setting areas apply specifically to kits: In the KIT setting area, you can specify a volume, configure effects, and set other parameters affecting the entire kit; in the VOICE setting area, you can assign preset voices, patterns, and waves to each pad, foot switch, and controller, and you can also set parameters such as tuning and volume for each of the assigned voices; and in the MIDI setting area, you can set MIDI-related parameters affecting the kit or individual pads and controllers. Setting a preset voice, pattern, or wave to be played when a pad is struck involves the following two steps.

1. Indication of the MIDI note number(s) to be sent when a specific pad is struck. (MIDI setting area)
2. Indication of the preset voice, pattern, or wave to be played for each MIDI note number. (VOICE setting area)

In cases where only a single layer is setup for a pad, however, it is possible to omit Step 1 above. (The required setting will be performed automatically when you select a voice in Step 2.)

The following two methods of allocating voices are described below.

- Assigning a voice directly to a pad
- Specifying MIDI note numbers and assigning voices to each

● **Assigning a voice directly to a pad**

In order to assign a voice directly to a pad, we first select the pad to be set, and then choose the required preset voice, pattern, or wave.

- 1 To start, press the [KIT] button to access the KIT setting area. On the Select Kit page (KIT1), select the kit to be set. Next, press the [VOICE] button to access the VOICE setting area and navigate to the Select Voice page (VCE1).

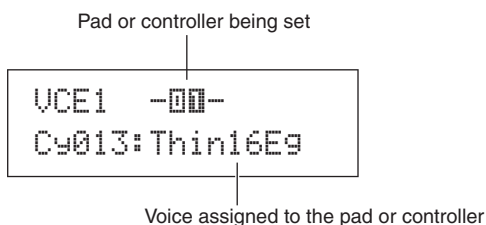

- 2 Move the flashing cursor to the upper row of text, and using the [-/DEC] and [+/INC] buttons, select the pad or controller you want to set. You can also select a pad by striking it. The lower row of text will show the voice (i.e., a preset voice, pattern, or wave) currently assigned to the selected pad or controller. Move the flashing cursor down to the lower row of text, and using the [-/DEC] and [+/INC] buttons, select the new voice to be assigned.

By repeating this process to assign preset voices, patterns, and waves to all pads and controllers, you can quickly and conveniently setup your own personalized drum kit. Furthermore, parameters such as volume, tuning, stereo pan, and effect levels can be set for the voices assigned to the various pads and controllers.

- 3 Once you have finished configuring a kit in this way, you can store it as one of the instrument's User kits.

Example: Working with Preset kit 1

KIT setting area

KIT1
P009:Oak Custom

Kit name

Settings made in KIT setting area

- Volume of the entire kit
- Kit tempo
- Effect settings for the entire kit
- Muting
- Hi-hat settings etc.

VOICE setting area

VCE1 -00-
Cy013:Thin16E9

VCE1 -00-
HH005:Brute Op

VCE1 -00-
Sn001:Oak Custom

VCE1 -000-
Sn002:OakCtm0FRm

VCE1 -000-
Sn003:OakCtmC1Rm

VCE1 -00-
Kk001:OakCtm22

VCE1 -00-
HH006:Brute E90P

VCE1 -000-
-----!

VCE1 -000-
HH003:Brute FtC1

VCE1 -000-
HH004:Brute FtOp

Assigning voices to built-in pads 1 to 12.

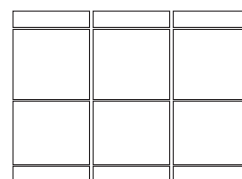

Assigning voices to pads connected via the PAD jacks 13 to 17.

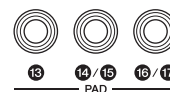

Assigning a voice* to a controller or foot switch connected via the FOOT SW jack.

Assigning a voice* to a controller connected via the HI-HAT CONTROL jack.

Settings made in VOICE setting area

- Volume of each pad (or layer)
- Tuning of each pad
- Stereo pan of each pad
- Effect settings for each pad etc.

*: Voices cannot be assigned to any controller or foot switch already having a function assigned on the Pad Function page (UTIL4-1).

Reference
KIT
VOICE
MIDI
WAVE
PATTERN
UTILITY
TRIGGER

● Specifying MIDI note numbers and assigning voices to each

The second approach to configuring a pad involves setting one or more MIDI note numbers to be sent whenever the pad is struck and then telling the internal tone generator which voices to play when MIDI notes with these numbers are received. In contrast to the direct approach described above, this method allows multiple MIDI Note messages to be sent from a single pad in order to play layered or alternating voices using the Layer function. In addition, these MIDI Note messages can also be output via the MIDI OUT connector or USB TO HOST port in order to control another MIDI instrument.

In the following example, we will setup built-in Pad 1 to play two different voices simultaneously when it is struck.

- 1 Press the [KIT] button to access the KIT setting area. On the Select Kit page (KIT1), select the kit to be set.
- 2 Press the [MIDI] button to access the MIDI setting area and navigate to the Select Message Type page (MIDI1).

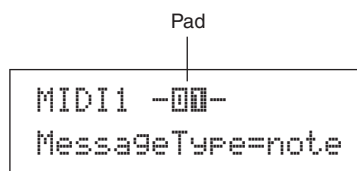

In the upper row of text, select “-00-” as the pad to be set. Following this, move the flashing cursor to the lower row of text and set the Message Type parameter to “note” (indicating that a MIDI Note message will be sent when the pad is struck).

- 3 Press the [ENTER] button to open the Playing Mode page (MIDI1-1).

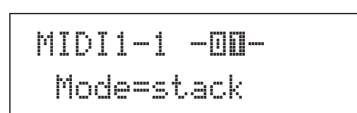

In the lower row of text, set the Mode parameter to “stack” (indicating that all MIDI notes assigned to the pad will be played simultaneously).

NOTE

- In addition to “stack”, you can also set the Mode parameter to “alternate”, which causes the notes assigned to the pad to play individually in turn each time it is struck, or “hold”, which causes the notes to be alternately turned on and off each time the pad is struck. (See page 62.)

- 4 Press the [➤] button to navigate to the MIDI Note page (MIDI1-2).

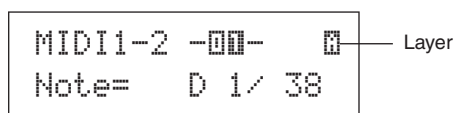

On this page, we can set the MIDI notes to be sent by the pad. Specifically, the Note parameter on the lower row of text is used to set a MIDI note number, while the indicator in the top right corner shows which of the pad’s four layers (A to D) is being set. For now, select “D1/38” as the MIDI note to be sent by Layer A.

- 5 Press the [VOICE] button to access the VOICE setting area and navigate to the Select Voice page (VCE1).

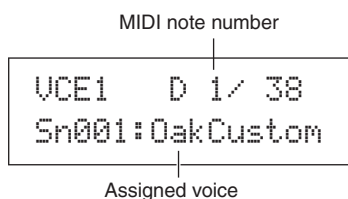

On the upper row of text, use the [-/DEC] and [+/INC] buttons to select “D1/38” – that is, the MIDI note number that Layer A of Pad 1 will send. On the lower row of text, set “Sn001:OakCustom” as the voice to be played for that MIDI note number.

With the settings now made, a MIDI note with MIDI note number 38 (i.e., D1) will be sent to the internal tone generator whenever Pad 1 is struck, and the tone generator will respond by playing the preset voice Sn001 (OakCustom).

Next, we will setup Pad 1 to also send the MIDI note number 40 (E1) whenever struck, and we will tell the internal tone generator to play the preset voice Cy013 (Thin16Eg) in response.

- 6 Press the [MIDI] button to access the MIDI setting area and navigate to the MIDI Note page (MIDI1-2).

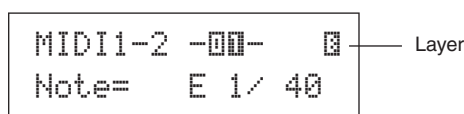

Move the flashing cursor to the “ ” indicator in the top right corner, and using the [+/INC] button, change this to “ ”. Move back to the lower row of text, and set “E1/40” as the MIDI note number to be sent by Layer B.

- 7 Press the [VOICE] button, navigate to the Select Voice page (VCE1), and in the same way as described above, set "Cy013:Thin16Eg" as the voice to be played for MIDI notes with the MIDI note number 40 (E1).

```
VCE1   E 1/ 40
Cy013:Thin16Eg
```

With your DTX-MULTI 12 configured in this way, whenever you strike built-in Pad 1, two MIDI notes with the MIDI note numbers 38 (D1) and 40 (E1) will be simultaneously sent to the internal tone generator, and the tone generator will respond by playing the preset voices Sn001 (OakCustom) and Cy013 (Thin16Eg) together.

The following diagram illustrates exactly what happens inside the instrument when Pad 1 has been setup to play two voices simultaneously as described above.

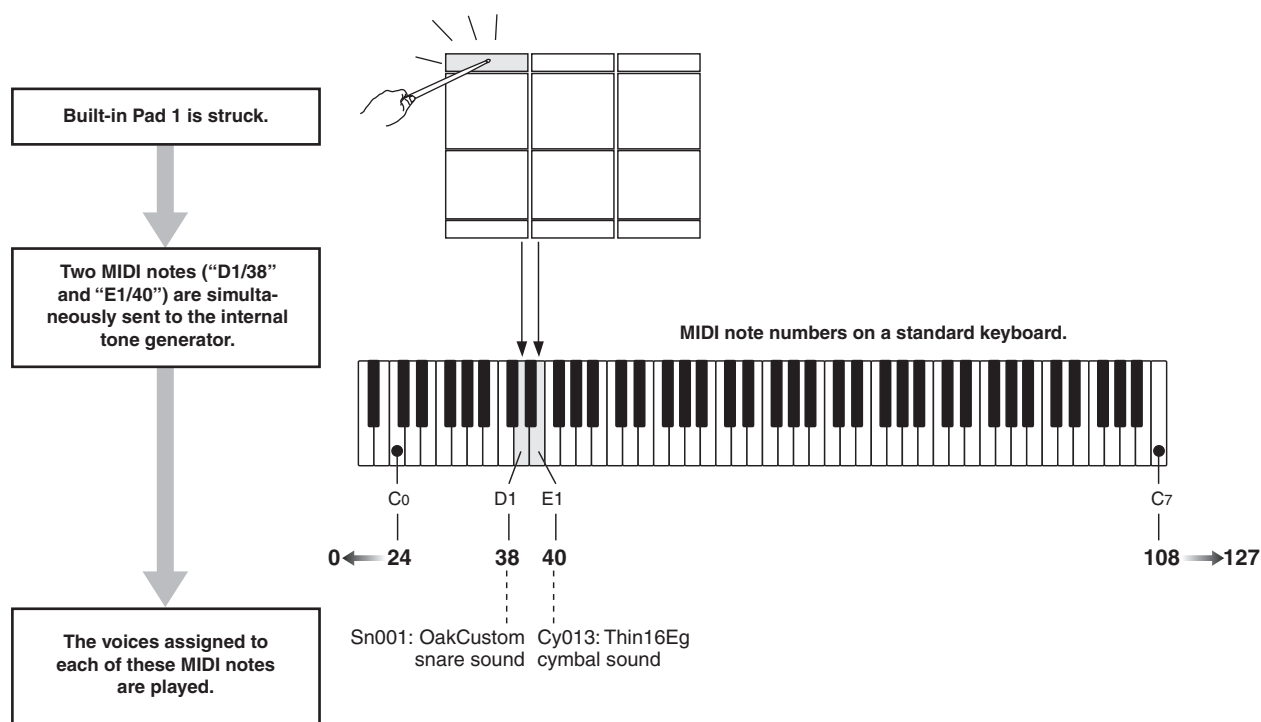

■ Using the DTX-MULTI 12 as a MIDI Controller

Instead of MIDI Note messages, the DTX-MULTI 12 can be setup to send MIDI Program Change messages, MIDI Control Change messages, and the like to MIDI devices connected via the MIDI OUT connector or USB TO HOST port whenever pads are struck or external controllers are operated. Using this functionality, you can easily configure pads to, for example, start and stop playback on a MIDI sequencer or to change presets on a MIDI instrument.

In contrast to the type of control introduced in the Pads & Trigger Signals section (see page 28), which makes it possible to play the DTX-MULTI 12 with trigger signals sent from a controller or foot switch connected via the FOOT SW jack, the MIDI control function allows the instrument's built-in pads and external pads to operate as versatile MIDI controllers. In addition to selecting frequently-used kits and patterns or setting the tempo for click-track or pattern playback, this powerful function also allows you to assign MIDI Control Change numbers (01 to 95) and values to pads in order to facilitate a wide range of unique modes of use.

Effects

The effect processor built into your DTX-MULTI 12 applies special audio effects to the output from the tone generator in order to modify and enhance its sound in a wide variety of ways. Normally applied during the final stages of editing, such effects allow you to optimize the sound in line with your own specific requirements.

■ Effect Processor Structure

This instrument can apply effects to the tone generator's output using the following four effect units.

● Variation

Variation effects allow you to sculpt your sound in a variety of different ways. A specific type of variation effect can be selected for each kit within the VARIATION section (KIT4); furthermore, you can also specify the degree to which this effect is applied to each layer on the Variation Send page (VCE4-1).

● Chorus

Chorus effects change the spatial characteristics of the sounds to which they are applied. A specific type of chorus effect can be selected for each kit within the CHORUS section (KIT5); furthermore, you can also specify the degree to which this effect is applied to each layer on the Chorus Send page (VCE4-2).

● Reverb

Reverb effects add a warm ambience to sounds, simulating the complex reflections of actual performance spaces, such as a concert hall or a small club. A specific type of reverb can be selected for each kit within the REVERB section (KIT6); furthermore, you can also specify the degree to which this effect is applied to each layer on the Reverb Send page (VCE4-3).

NOTE

- The degree to which User patterns are processed by these effect units can be specified on the Variation Send page (PTN3-5), the Chorus Send page (PTN3-6), and the Reverb Send page (PTN3-7); furthermore, these settings can then be saved as part of the User pattern data.

● Master EQ

Processing the overall instrument sound just before output, the Master EQ supports five-band equalization. As this equalization is applied to the sound of the entire instrument and not that of individual drum kits or voices, Master EQ settings do not change whenever a new drum kit is selected. To set the corresponding parameters, use the parameter-setting pages from the UTILITY setting area's MASTER EQ section (UTIL3).

■ Effect Connection

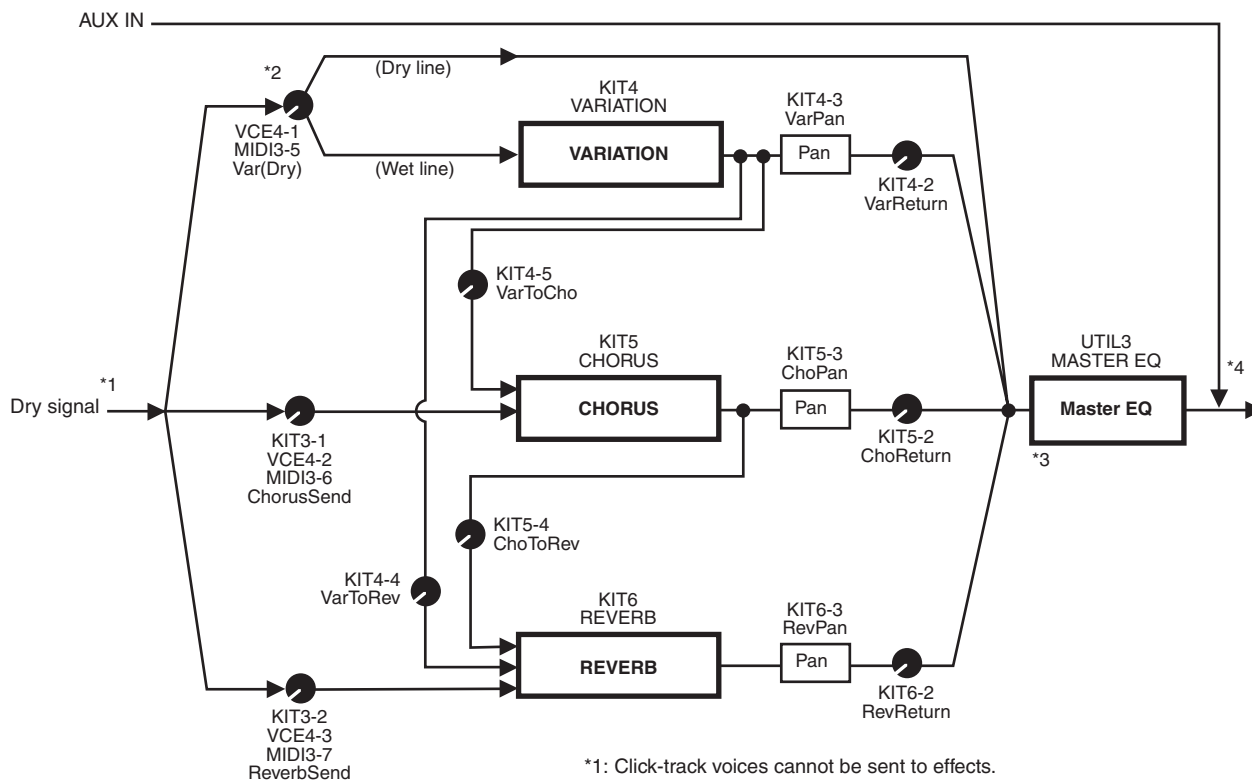

*1: Click-track voices cannot be sent to effects.

*2: On the Variation Send page (VCE4-1), you can set the required balance between the amount of the signal that will bypass the effect (i.e., the dry level) and the amount that will be sent to the effect (i.e., the wet level).

*3: Master EQ is not applied to the headphone output.

*4: External audio signals (AUX IN) bypass all effects.

■ Effects & Effect Categories

The various individual effects provided by this instrument's effect units are sorted into a number of different categories. What follows is a description of each category and the effects it contains. We recommend that you refer to these descriptions whenever setting effects. Each category's effect table indicates which of the effect units – i.e., Reverb (Rev), Chorus (Cho), or Variation (Var) – can be used to apply the effect in question. Any effect marked using a ✓ symbol can be selected and modified on the corresponding effect unit's parameter setting pages.

● Compressor & EQ

The compressor is an effect commonly used to limit and compress the dynamics (i.e., softness or loudness) of an audio signal. In the case of vocals, guitar parts, and other signals that have widely varying dynamics, this effect essentially squeezes the dynamic range, making soft sounds louder and loud sounds softer. Furthermore, a compressor's attack and decay characteristics can be adjusted to modify how punchy or sustained an audio signal sounds. Multi-band compression, meanwhile, splits the input into three different frequency bands for processing independently of each other; accordingly, this type of effect can be thought of as combining compression with equalization.

Effect Type	Var	Description
Compressor	✓	Relatively fast-acting compressor well suited to solo performances.
MltBndComp	✓	Three-band compressor.
3 Band EQ	✓	Three-band compressor also featuring equalization.
Vintage EQ	✓	Vintage five-band parametric equalizer.
Enhancer	✓	Adds higher-order harmonics to enhance a sound's presence.

● Flanger & Phaser

A flanger creates a swirling, metallic sound, similar to that of a jet plane. While this effect operates using the same basic principles as chorus effects, it uses shorter delay times and also incorporates feedback to produce a very distinctive swelling sound. Rather than being used constantly throughout a song, it is more suited to selective use in specific sections in order to add variety. A phaser, meanwhile, introduces a phase shift into the sound being processed before returning it to the effect input using a feedback circuit in order to produce a characteristic animated yet mellow tone. Gentler overall than a flanger, this effect can be put to use in a wider range of situations, and for example, is often used with electric pianos to sweeten their sound in a variety of ways.

Effect Type	Cho	Var	Description
SPX Flanger	✓	✓	Produces a swirling, metallic sound.
TempoFlanger	✓	✓	Tempo-synchronized flanger.
PhaserMono	–	✓	Vintage sounding mono phaser.
PhaserStereo	–	✓	Vintage sounding stereo phaser.
TempoPhaser	–	✓	Tempo-synchronized phaser.

● Distortion

As its name suggests, a distortion effect distorts the sound fed into it. It produces a sound similar to that of an amplifier turned up too high or fed with a signal that is already sufficiently loud. This type of effect is widely used to add a harsh, biting edge; furthermore, the resultant sound is characterized by overall thickness and long sustain times. This thickness comes from the large numbers of harmonics contained within clipped signals. Meanwhile, the longer sustain is not produced by the original sound being stretched; rather, it is produced when the slowly-fading release portion that cannot normally be heard is amplified and distorted.

Effect Type	Var	Description
AmpSim 1	✓	Guitar amp simulation.
AmpSim 2	✓	Guitar amp simulation.
CompDist	✓	Combines compression and distortion.
CompDistDly	✓	Combines compression, distortion, and delay.

● Wah

A wah effect dynamically changes the frequency characteristic of a filter in order to produce a highly unique filter-sweep sound. Auto wah changes the frequency in a cyclic manner using an LFO, while touch wah performs filter sweeps in response to the volume of the input signal.

Effect Type	VAR	Description
AutoWah	✓	Vintage automatic wah effect.
TouchWah	✓	Classic volume-responsive wah effect.
TouchWahDist	✓	Touch wah with distortion applied at the output.

● Reverb

Reverb effects model the complex reverberation produced by sounds within enclosed spaces. In this way, they add a natural-sounding sustain, which produces a feeling of depth and space. Furthermore, different types of reverb – such as hall, room, plate, and stage – can be used to simulate the sound of acoustic environments of varying sizes and constructions.

Effect Type	Rev	Var	Description
SPX Hall	✓	✓	Emulation of hall acoustics using an algorithm derived from the classic Yamaha SPX1000 Digital Multi-Effects Processor.
SPX Room	✓	✓	Emulation of room acoustics using an algorithm derived from the classic Yamaha SPX1000 Digital Multi-Effects Processor.
SPX Stage	✓	✓	Emulation of stage acoustics using an algorithm derived from the classic Yamaha SPX1000 Digital Multi-Effects Processor.
R3 Hall	✓	–	Emulation of the acoustics of a concert hall using an algorithm derived from the Yamaha ProR3 – a digital reverberator for professional-audio applications.
R3 Room	✓	–	Emulation of room acoustics using an algorithm derived from the above-mentioned Yamaha ProR3.
R3 Plate	✓	–	Emulation of plate reverb using an algorithm derived from the above-mentioned Yamaha ProR3.
EarlyRef	–	✓	Early reflections without any subsequent reverberation.
GateReverb	–	✓	Simulation of gated reverb.
ReverseGate	–	✓	Simulation of gated reverb played in reverse.

● Chorus

Chorus reproduces the sound of multiple instruments playing in unison for a thicker, deeper tone. As all instruments differ slightly from each other in terms of pitch and phase, their playing together produces an overall sound that is warmer and more spacious. In order to reproduce this type of behavior, chorus effects make use of delay. Specifically, a delayed, second version of the original signal is produced and given a vibrato-type effect by varying its delay time over a period of approximately one second using an LFO. When this second version is mixed back into the original signal, the resulting tone sounds as if multiple instruments are being played in unison.

Effect Type	Var	Cho	Description
G Chorus	✓	✓	Rich, deep chorus with complex modulation.
2 Modulator	✓	✓	Chorus effect allowing pitch and amplitude modulation to be adjusted for a more natural, spacious tone.
SPX Chorus	✓	✓	Enhances modulation and spaciousness using a 3-phase LFO.
Symphonic	✓	✓	Multi-stage modulation for a wider-sounding chorus.
Ensemble	–	✓	Modulation-free chorus achieved by adding a slightly pitch-shifted sound.

● Tremolo & Rotary

Tremolo effects are characterized by the way in which they modulate volume in a cyclical fashion. An auto-pan effect, meanwhile, moves the sound from left to right in a similar cyclical manner, and a rotary speaker effect simulates the distinctive vibrato of rotary-type speakers often used with organs. In a rotary speaker, the horn and rotor are spun in order to create highly unique sounds using the Doppler Effect.

Effect Type	Var	Description
AutoPan	✓	Cyclically moves the sound between left and right channels.
Tremolo	✓	Cyclically modulates the volume of the processed signal.
RotarySp	✓	Rotary speaker simulator.

● Delay

Delay effects create a delayed version of the input signal, and as such, they can be used for many different purposes, such as creating a sense of spaciousness or thickening a sound.

Effect Type	Var	Description
CrossDelay	✓	A pair of delays featuring cross-over feedback to produce a sound that swirls between the left and right channels.
TempoCrosDly	✓	A pair of delays with cross-over feedback and a tempo-synchronized delay time.
TempoDlyMono	✓	A single mono delay synchronized with the instrument's tempo.
TempoDlySt	✓	A stereo delay synchronized with the instrument's tempo.
Delay LR	✓	A delay with separate left and right channels.
Delay LCR	✓	A triple delay processing left, right, and center channels independently.
Delay LR St	✓	A stereo delay with fully independent left and right channels.

● Miscellaneous

This category contains effect types not included in the other categories.

Effect Type	Var	Description
Isolator	✓	Controls the volume of individual frequency bands using powerful filters.
Telephone	✓	Reproduces the sound of telephone speech by cutting high and low frequencies.
TalkingMod	✓	Incorporates a vowel-type formant into the input signal.
PitchChange	✓	Changes the pitch of the input signal.

■ Effect Parameters

Each of the above-mentioned effects includes a range of parameters allowing you to adjust the way in which it processes the input signal. Using these parameters, the behavior of each effect can be optimized in line with, for example, the type of sound being processed or the type of music being played. While the function of each of these parameters is described in the following table, it is good practice to also listen to how they actually change the sound of the respective effect in order to achieve the best settings.

● Parameters with identical names

NOTE

- Certain effects contain parameters with identical names yet performing different functions. In the following table, the function of each such parameter is described separately and the corresponding effects are identified.

Parameter name	Descriptions
AMDepth	This parameter is used to set the depth of amplitude modulation.
AmpType	This parameter is used to set the type of amplifier to be simulated.
Attack	This parameter is used to set the amount of time that elapses before compression is fully applied.
Bottom*1	This parameter is used to set the lowest point in the filter's sweep range.
Color*2	This parameter is used to set the fixed phase modulation.
CommonRel	This parameter is used to set the amount of time that elapses before the compressor stops processing the input signal (common for all three bands).
Compres	This parameter is used to set the input-signal level at which the compressor starts to process the sound (i.e., the threshold).
Cutoff	This parameter is used to set the offset value for the filter's control frequency.
Delay	This parameter is used to set the delay time in terms of note lengths.
DelayC	This parameter is used to set the delay time for the center channel.
DelayL	This parameter is used to set the delay time for the left channel.
DelayL>R	This parameter is used to set the time that elapses between input of sound via the left channel and output via the right channel.
DelayR	This parameter is used to set the delay time for the right channel.
DelayR>L	This parameter is used to set the time that elapses between input of sound via the right channel and output via the left channel.
Density	[Reverb effects other than EarlyRef] This parameter is used to set the reverb density. [Early Ref] This parameter is used to set the density of early reflections.
Depth	This parameter is used to set the amplitude of the LFO wave that controls cyclic changes in phase modulation.
Detune	This parameter is used to set the degree to which pitches are detuned.
Device	This parameter is used to select one of a number of devices that distort the sound in different ways.
Diffuse	[TempoPhaser and EarlyRef] This parameter is used to adjust the spaciousness of the sound produced. [Reverb effects other than EarlyRef] This parameter is used to set how wide the reverb sounds.
Directn	This parameter is used to set the direction of envelope-follower modulation.
Div.FreqH	This parameter is used to set the mid-high frequency when splitting the sound into three bands.
Div.FreqL	This parameter is used to set the low-mid frequency when splitting the sound into three bands.

*1 The Bottom parameter's setting is valid only when less than that of the Top parameter.

*2 The Color parameter's setting has no effect with certain combinations of Mode and Stage settings.

Parameter name	Descriptions
DlyLvIC	This parameter is used to set the delay volume for the center channel.
DlyMix	This parameter is used to set the mixing level for the delayed sound.
DlyOfst	This parameter is used to set the modulation delay time's offset value.
Drive	This parameter is used to set the degree to which the effect is applied.
DriveHorn	This parameter is used to set the depth of modulation produced through rotation of the high-frequency horn.
DriveRotor	This parameter is used to set the depth of modulation produced through rotation of the low-frequency rotor.
DstL.Gain	This parameter is used to set the degree by which the low frequencies from the distorted sound are boosted or cut.
DstM.Gain	This parameter is used to set the degree by which the mid frequencies from the distorted sound are boosted or cut.
Edge	This parameter is used to specify a curve that determines how the sound is distorted.
EQ1Freq	This parameter is used to set the cutoff frequency for the EQ1 band (i.e., low shelving).
EQ1Gain	This parameter is used to set the gain for the EQ1 band (i.e., low shelving).
EQ2Freq	This parameter is used to set the center frequency for the EQ2 band.
EQ2Gain	This parameter is used to set the gain for the EQ2 band.
EQ2Q	This parameter is used to set the resonance of the EQ2 band.
EQ3Freq	This parameter is used to set the center frequency for the EQ3 band.
EQ3Gain	This parameter is used to set the gain for the EQ3 band.
EQ3Q	This parameter is used to set the resonance of the EQ3 band.
EQ4Freq	This parameter is used to set the center frequency for the EQ4 band.
EQ4Gain	This parameter is used to set the gain for the EQ4 band.
EQ4Q	This parameter is used to set the resonance of the EQ4 band.
EQ5Freq	This parameter is used to set the cutoff frequency for the EQ5 band (i.e., high shelving).
EQ5Gain	This parameter is used to set the gain for the EQ5 band (i.e., high shelving).
ER/Rev	This parameter is used to set the relative volumes of early reflections and reverberation.
F/RDpth	This parameter is used to set the front-to-rear pan depth (and is valid only when PanDirectn is set to "Lturn" or "Rturn").
FBHiDmp	This parameter is used to set how the feedback sound decays in the high-frequency band (with smaller values corresponding to faster decay).
FBLevel	[Chorus effects, Delay effects, and TempoFlanger] This parameter is used to set how much of the delay sound is fed back into the effect's input (with negative values indicating that its phase is to be inverted).
	[TempoPhaser] This parameter is used to set how much of the phaser's output is fed back into its input (with negative values indicating that its phase is to be inverted).
	[Reverb effects] This parameter is used to set the initial delay's feedback level.
FBLvl1	This parameter is used to set the feedback level for the first delay sound.
FBLvl2	This parameter is used to set the feedback level for the second delay sound.
FBTime	This parameter is used to set the feedback delay time.
FBTime1	This parameter is used to set the delay time for feedback delay 1.
FBTime2	This parameter is used to set the delay time for feedback delay 2.

Parameter name	Descriptions
FBTimeL	This parameter is used to set the delay time for the left feedback delay.
FBTimeR	This parameter is used to set the delay time for the right feedback delay.
Feedback	This parameter is used to set how much of the effect's output is fed back into its input.
Fine1	This parameter is used to adjust the first fine-pitch setting.
Fine2	This parameter is used to adjust the second fine-pitch setting.
H.Freq	This parameter is used to set the center frequency of the high-frequency EQ band.
H.Gain	This parameter is used to set the amount by which the high-frequency EQ band is boosted or cut.
Height	This parameter is used to set the height of the simulated room.
HiAtk	This parameter is used to set the amount of time that elapses before compression is fully applied in the high-frequency band.
HiGain	This parameter is used to set the output level of the high-frequency band.
HiLvl	This parameter is used to set the high-frequency level.
HiMute	This parameter is used to activate and deactivate high-frequency muting.
HiRat	[MltBndComp] This parameter is used to set the compression ratio for the high-frequency band.
	[Reverb effects] This parameter is used to adjust the high-frequency component.
HiTh	This parameter is used to set the input-signal level at which the compressor starts to process the sound in the high-frequency band.
HornF	This parameter is used to set the speed of rotation of the high-frequency horn at the "fast" setting.
HornS	This parameter is used to set the speed of rotation of the high-frequency horn at the "slow" setting.
HPF	This parameter is used to set the high-pass filter's cutoff frequency.
InitDly	This parameter is used to set the amount of time that elapses before early reflections are produced.
InitDly1	This parameter is used to set the delay time for the first delay.
InitDly2	This parameter is used to set the delay time for the second delay.
InitDlyL	This parameter is used to set the delay time for the left-channel delay.
InitDlyR	This parameter is used to set the delay time for the right-channel delay.
InpMode	This parameter is used to switch between mono and stereo input.
InpSelect	This parameter is used to select an input.
L.Freq	This parameter is used to set the center frequency of the low-frequency EQ band.
L.Gain	This parameter is used to set the amount by which the low-frequency EQ band is boosted or cut.
L/RDiffuse	This parameter is used to set the difference between left and right delay times in order to produce a more spacious sound.
L/RDpth	This parameter is used to set the depth of the left-right panning effect.
Lag	This parameter is used to set a time lag for delay times specified in terms of note lengths.
LFODpth	[SPX Flanger, TempoFlanger, SPX Chorus, and Symphonic] This parameter is used to set the depth of modulation.
	[Tempo Phaser] This parameter is used to set the depth of phase modulation.
LFODiff	This parameter is used to set the left-right phase difference between modulation waveforms.

Parameter name	Descriptions
LFOspeed	[TempoFlanger, G Chorus, 2 Modulator, SPX Chorus, Symphonic, and Tremolo] This parameter is used to set the modulation frequency.
	[TempoPhaser] This parameter is used to set the modulation speed in terms of note lengths.
	[AutoPan] This parameter is used to set the auto-pan frequency.
LFOWave	[AutoWah] This parameter is used to specify whether the filter-sweep effect is produced using a sine or square wave.
	[AutoPan] This parameter is used to set the panning curve.
Livenss	This parameter is used to set the way in which early reflections decay.
LowAtk	This parameter is used to set the amount of time that elapses before compression is fully applied in the low-frequency band.
LowGain	This parameter is used to set the output level of the low-frequency band.
LowLvl	This parameter is used to set the low-frequency level.
LowMute	This parameter is used to activate and deactivate low-frequency muting.
LowRat	[MltBndComp] This parameter is used to set the compression ratio for the low-frequency band.
	[Reverb effects] This parameter is used to adjust the low-frequency component.
LowTh	This parameter is used to set the input-signal level at which the compressor starts to process the sound in the low-frequency band.
LPF	This parameter is used to set the low-pass filter's cutoff frequency.
M.Freq	This parameter is used to set the center frequency of the mid-frequency EQ band.
M.Gain	This parameter is used to set the amount by which the mid-frequency EQ band is boosted or cut.
M.Width	This parameter is used to set the width of the mid-frequency EQ band.
Manual	This parameter is used to set the phase-modulation offset value.
MicAngl	This parameter is used to set the left-right inclination of the microphone used to capture the speaker's output.
MidAtk	This parameter is used to set the amount of time that elapses before compression is fully applied in the mid-frequency band.
MidGain	This parameter is used to set the output level of the mid-frequency band.
MidLvl	This parameter is used to set the mid-frequency level.
MidMute	This parameter is used to activate and deactivate mid-frequency muting.
MidRat	This parameter is used to set the compression ratio for the mid-frequency band.
MidTh	This parameter is used to set the input-signal level at which the compressor starts to process the sound in the mid-frequency band.
MixLvl	This parameter is used to set how much of the effect sound is mixed back into the dry sound.
Mode	This parameter is used to adjust the mode of operation of the phaser.
MoveSpeed	This parameter is used to specify the amount of time that elapses until the sound set using the Vowel parameter is produced.
On/Off	This parameter is used to activate and deactivate the isolator.
OutLvl	This parameter is used to set the output level.
OutLvl1	This parameter is used to set the first-stage output level.
OutLvl2	This parameter is used to set the second-stage output level.
Output	This parameter is used to set the output level.

Parameter name	Descriptions
OverDr	This parameter is used to adjust the way in which the sound distorts.
Pan1	This parameter is used to set the first stereo-panning position.
Pan2	This parameter is used to set the second stereo-panning position.
PanDirectn	This parameter is used to set the auto-pan type.
PhShiftOfst	This parameter is used to set the phase-modulation offset value.
Pitch1	This parameter is used to set the first pitch in semi-tone units.
Pitch2	This parameter is used to set the second pitch in semi-tone units.
PMDepth	This parameter is used to set the depth of pitch modulation.
Presenc	Often seen on guitar amplifiers and the like, this parameter is used to control the high-frequency band.
Ratio	This parameter is used to set the compression ratio.
Release	This parameter is used to set the amount of time that elapses until the sound is no longer being compressed.
Resonance	This parameter is used to set the resonance of the filter.
ResoOfst	This parameter is used to set the resonance offset value.
RevDly	This parameter is used to set the interval between early reflections and subsequent reverberation.
RevTime	This parameter is used to set the reverb time.
RoomSize	This parameter is used to set the size of the room.
Rotor/Horn	This parameter is used to set the relative volumes of the high-frequency horn and the low-frequency rotor.
RotorF	This parameter is used to set the speed of rotation of the low-frequency rotor at the "fast" setting.
RotorS	This parameter is used to set the speed of rotation of the low-frequency rotor at the "slow" setting.
Sens	This parameter is used to set how sensitive the wah filter is to changes in the input level.
S-FTmHorn	This parameter is used to set how long it takes for the high-frequency horn to switch between fast and slow rotation speeds.
S-FTmRotor	This parameter is used to set how long it takes for the low-frequency rotor to switch between fast and slow rotation speeds.
Speaker	This parameter is used to select the type of speaker to be simulated.
Speed	[PhaserMono and PhaserStereo] This parameter is used to set the frequency of the LFO that controls cyclic changes in phase modulation.
	[AutoWah] This parameter is used to set the LFO speed.
SpeedCtrl	This parameter is used to set the rotation speed as "fast" or "slow".
Spread	This parameter is used to set how wide the effect's output sounds.
Stage	This parameter is used to set the number of phase-filter steps.
Thresh	This parameter is used to set the input-signal level at which the effect starts to process the sound.
Top ^{*3}	This parameter is used to set the highest point in the filter's sweep range.
Type	[Wah effects] This parameter is used to set the wah-effect type.
	[EarlyRef, GateReverb, and ReverseGate] This parameter is used to set the reflected-sound type.
Vowel	This parameter is used to select a vowel type.

*3 The Top parameter's setting is valid only when equal to or greater than that of the Bottom parameter.

Reference

KIT

VOICE

MIDI

WAVE

PATTERN

UTILITY

TRIGGER

Internal Memory

By storing User kits, User patterns, and waves that you have created and edited in the DTX-MULTI 12's internal memory, you ensure that they will always be available for use, even after the instrument has been turned off. In addition, User trigger setups and the settings from the UTILITY setting area can also be stored in memory for reuse.

■ Data Retained by the DTX-MULTI 12

The following types of setting data can be stored in the instrument's internal memory.

● User kits

Original drum kits that you have created by assigning voices to pads and external controllers can be stored as User kits in the instrument's memory. After doing so, you can then recall these kits at any time in the same way as Preset kits. In total, up to 200 User kits can be stored, and they will be available even after the DTX-MULTI 12 has been turned off. In addition to settings from the KIT area, each User kit also retains associated data configured in the VOICE and MIDI setting areas.

● User patterns

User patterns – which may be put to use in exactly the same way as Preset patterns – can be created by recording your performances on the DTX-MULTI 12 or by importing standard MIDI files (Format 0). The corresponding data is stored as a User pattern within the DTX-MULTI 12 as it is recorded or imported, and the pattern will then be available even after the DTX-MULTI 12 has been turned off. Up to 50 of these User patterns can be stored internally.

● Waves

Wave data created by importing either WAV or AIFF type audio files from a USB memory device (connected via the USB TO DEVICE port) is automatically stored within the DTX-MULTI 12 and can then be assigned to pads for playback in the same way as preset voices and patterns. In total, up to 500 of these waves can be stored, ensuring that they will be available even after the DTX-MULTI 12 has been turned off.

● User trigger setups

The DTX-MULTI 12 can also store a number of original User trigger setups, which you can conveniently prepare by customizing a Preset trigger setup. In specific terms, the instrument's internal memory can hold ten of these setups, ensuring that they will always be available, even after the power has been turned off and back on.

● UTILITY area settings

The parameter settings that you have configured within the UTILITY setting area can also be stored in the DTX-MULTI 12's internal memory. In this way, they can be instantly recalled whenever the instrument is turned on.

■ Editing & Storing User Kits

Whenever you select a drum kit, the corresponding data is loaded into a non-permanent area of internal memory known as the Edit Buffer. If any of the kit's parameter settings are changed, it is the data within the Edit Buffer – not the stored version – that is modified. In this way, User kits can be protected from accidental or unintended modification.

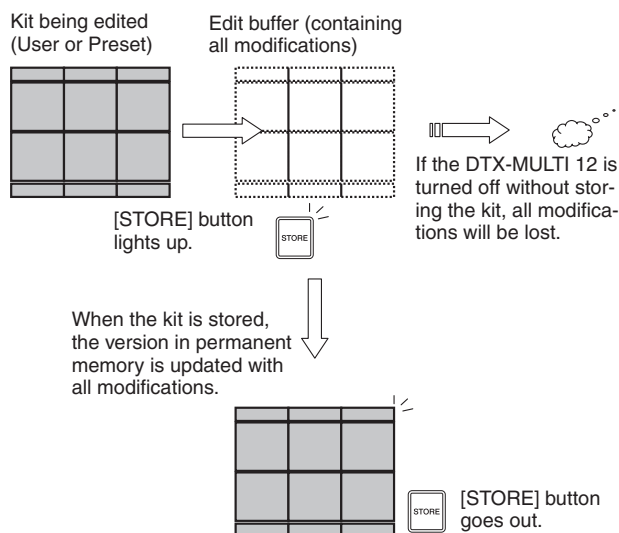

The purpose of the Edit Buffer is to hold a temporary version of the kit being edited, and therefore, if a new kit is selected without storing any modifications, those modifications will be lost (i.e., overwritten with the settings from the newly selected kit). In addition, modifications to the kit in the Edit Buffer will also be lost when the DTX-MULTI 12 is turned off if they are not stored in advance. It is good practice, therefore, to store the content of the Edit Buffer as a User kit whenever you are happy with it.

■ Saving & Loading Data Files

All of the above-mentioned items of data that can be stored in the instrument's internal memory can also be saved as files on a USB storage device. Whenever needed, furthermore, these memory files can be loaded back into the instrument from the storage device. For more details, refer to the description of the UTILITY setting area's FILE section (UTIL7).

■ Makeup of Internal Memory

The following diagram shows the correlation between the various functions that can be used to create data on the DTX-MULTI 12, the data in the instrument's internal memory, and the data on a USB memory device.

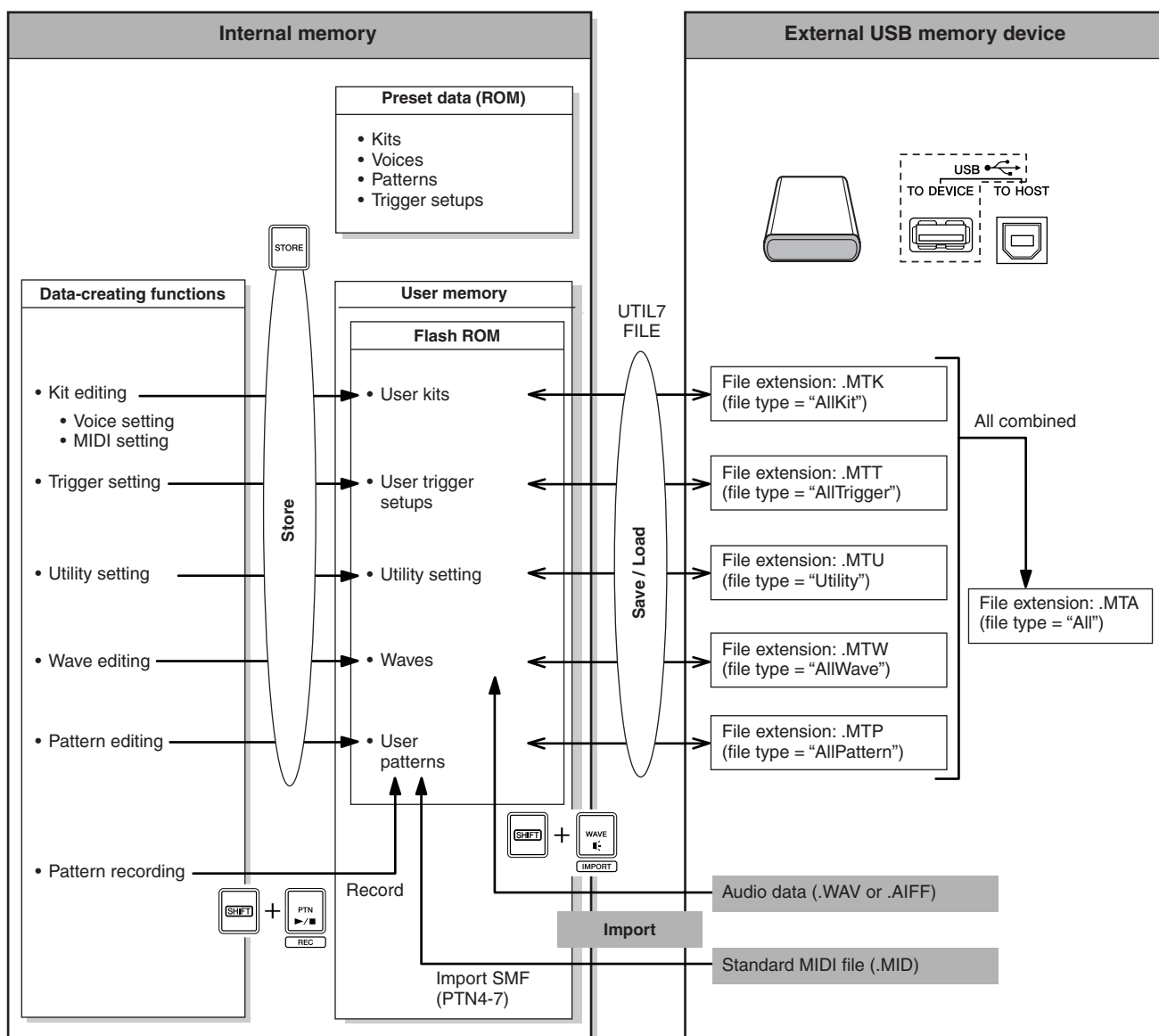

Reference

KIT

VOICE

MIDI

WAVE

PATTERN

UTILITY

TRIGGER

Basic Operations

The following section describes how to perform basic tasks such as the changing of parameter settings, execution of jobs, and storing of data.

■ Parameter Setting Areas

Within your DTX-MULTI 12, parameters associated with specific functions are conveniently grouped together into seven different parameter setting areas. These areas may be accessed using the buttons indicated below.

- **KIT setting area: [KIT] button**
This area is used to select and edit drum kits.
- **VOICE setting area: [VOICE] button**
A part of the KIT setting area, this area is used to select and edit voices.
- **MIDI setting area: [MIDI] button**
A part of the KIT setting area, this area is used to set MIDI-related parameters on an individual-kit basis.
- **PATTERN setting area: [PTN] button**
This area is used to select and edit patterns.
- **WAVE setting area: [WAVE] button**
This area is used to import and edit waves.
- **UTILITY setting area: [UTILITY] button**
This area is used to set parameters affecting the overall system and to manage files.
- **TRIGGER setting area: [SHIFT] + [UTILITY] buttons**
This area is used to edit trigger setup data.

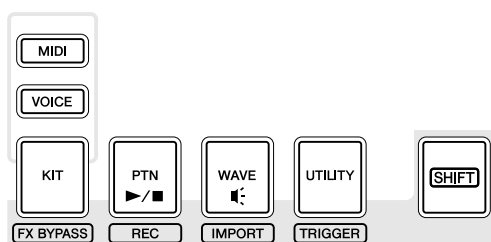

The button corresponding to each setting area will light up in green when that area is selected. In the case of the VOICE and MIDI setting areas, the [KIT] button will also light up.

■ Navigating between Sections

Each setting area is subdivided into a number of different sections. The current section is indicated at the left of the upper row of text using the name (or abbreviation) of the selected setting area together with the section number. Use the [<]/[>] buttons to navigate between these sections.

Example: UTILITY setting area

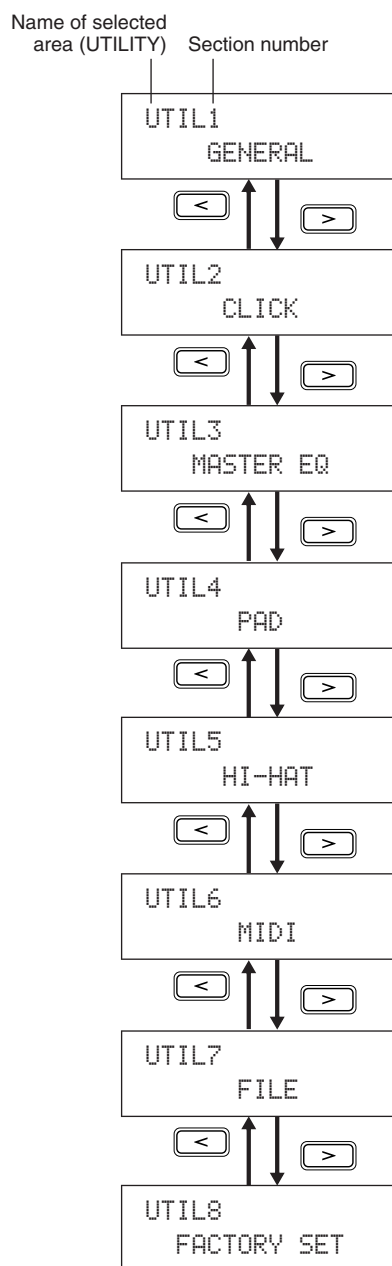

■ Navigating between Pages

Each section contains a number of parameter setting pages that are used to make actual settings. With a section page displayed, press the lit [ENTER] button to access its parameter setting pages. (In certain cases, it may not be possible to access parameter-setting pages from a section page, and the [ENTER] button will not light up.) Each parameter-setting page is identified at the left of the upper row of text using the name (or abbreviation) of the setting area, the section number, and the page number (with hyphens between the numbers). You can use the [<]/[>] buttons to navigate between parameter setting pages.

Example: VOICE setting area's TONE section (VCE3)

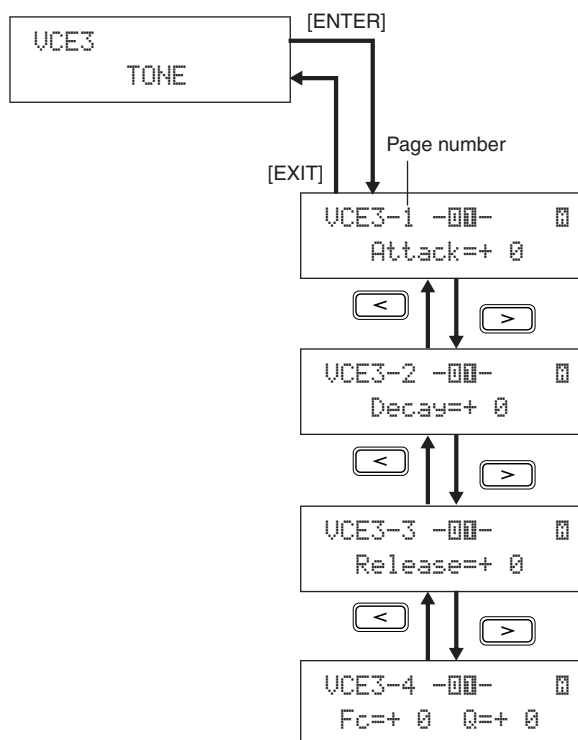

In certain cases, a number of additional pages may be accessed from a parameter setting page using the [ENTER] button, which will light up whenever this is possible. By pressing the [EXIT] button, you can move back towards the top of the current setting area.

■ Moving the Cursor

Whenever a page contains a number of different parameters, you can move the flashing cursor left and right using the [<]/[>] buttons or between the upper and lower rows of text using the [VA] button. In this way, you can select the parameter setting to be changed (as described below). If there are no additional parameters to the left or right on the current page when you press the [<]/[>] button, the cursor will jump to the next parameter-setting page to the left or right, respectively. In addition, the [<]/[>] and [VA] buttons will light up whenever they can be pressed to move to a different parameter on the current page or an adjacent page.

■ Changing Parameter Settings

By pressing the [-/DEC] or [+/INC] button, you can increase or decrease the setting of the currently selected parameter.

NOTE

- A setting can be decreased in units of 10 by holding down the [SHIFT] button and pressing the [-/DEC] button or by holding down the [-/DEC] button and pressing the [+/INC] button.
- Similarly, it can be increased in units of 10 by holding down the [SHIFT] button and pressing the [+/INC] button or by holding down the [+/INC] button and pressing the [-/DEC] button.

■ Storing Parameter Settings

Whenever parameter settings have been changed on section and/or parameter-setting pages, the [STORE] button will light up to remind you to store your settings. The correct way to store parameter settings is as follows.

- 1 When you have finished setting parameters in a specific setting area, press the [STORE] button to open the Store Kit page.

```
KIT Store to
U001:User Kit
```

Destination for stored data.

- 2 Using the [-/DEC] and [+/INC] buttons, indicate where you want your data to be stored.

NOTE

- The above step is not required when storing settings in the UTILITY setting area.

- 3 Press the [ENTER] button. You will be asked to confirm that you wish to proceed. If necessary, you can press the [EXIT] button to return to the previous page without storing any data.

```
KIT Store
Are you sure?
```

- 4 Press the [ENTER] button to store your data in the DTX-MULTI 12's internal memory.

⚠ CAUTION

- If you turn off the instrument without storing modified settings, these modifications will be lost (i.e., the settings will revert to their previous state when the instrument is next turned on).

KIT Setting Area (KIT)

This section describes the KIT setting area, which can be accessed using the [KIT] button. Your DTX-MULTI 12 is pre-loaded with a rich selection of Preset kits (P001 to P050) for immediate use, and you can also create and save up to 200 of your own drum kits as User kits (U001 to U200). Use the KIT setting area to select and edit these drum kits.

CAUTION

- Be sure to store any settings that you have edited before turning off the instrument or selecting a new kit. (See page 45.)

Makeup of KIT Setting Area

The KIT setting area is subdivided into eight different sections (KIT1 to KIT8). Use the [<]/[>] buttons to navigate between these sections. If a section contains parameter-setting pages, the [ENTER] button will light up. Press the [ENTER] button to access these pages. In certain cases, a number of additional pages may be accessed from a parameter setting page, also using the lit [ENTER] button. Furthermore, you can press the [EXIT] button to move back towards the top of the setting area.

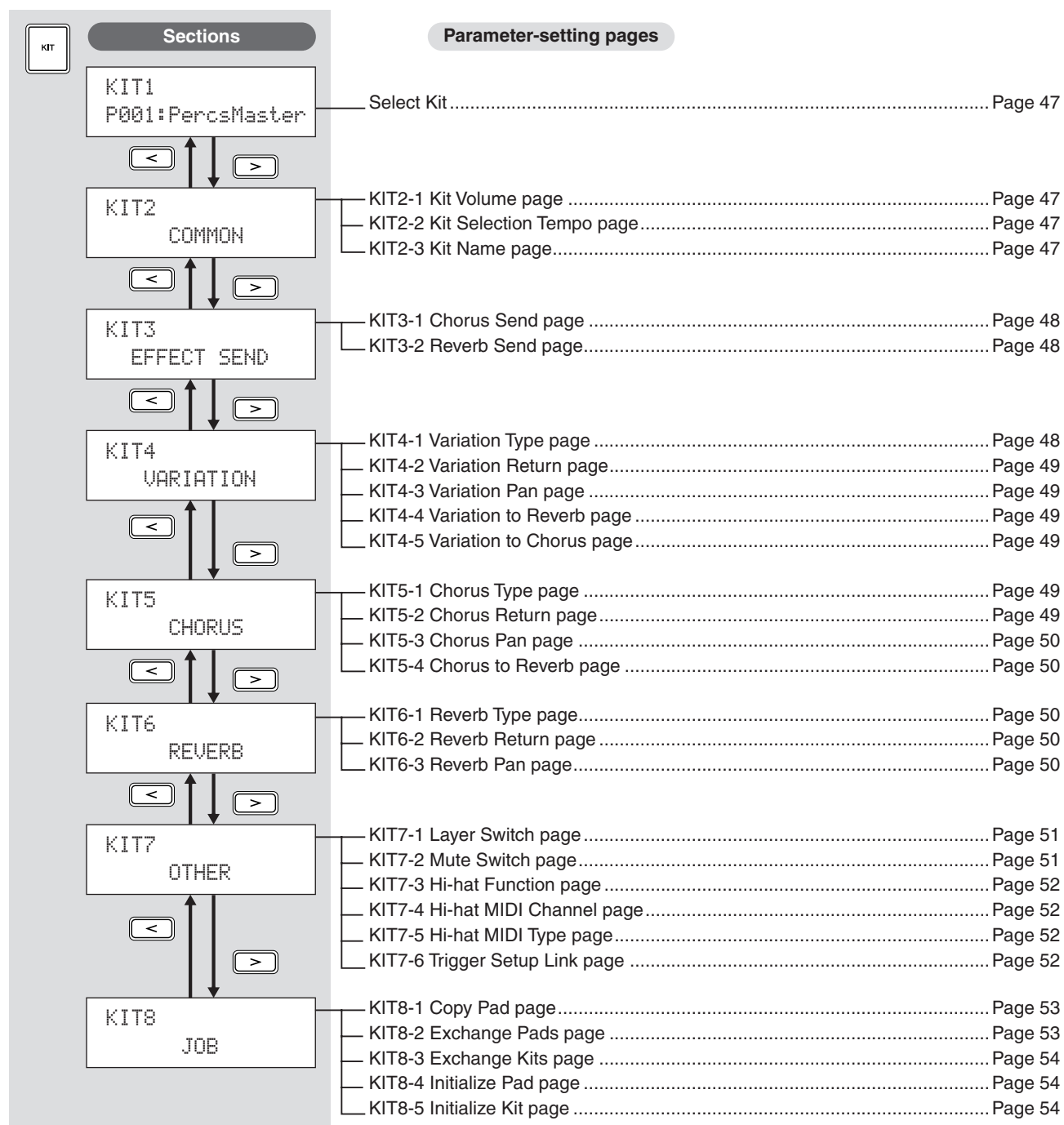

KIT1

Select Kit

On the Select Kit page (KIT1) you can select the Preset kit or User kit you want to play. To access this page, press the [KIT] button, and if necessary, the [<]/[>] buttons. Before you can edit pads or voices in the VOICE or MIDI setting areas, the drum kit in question must be selected on this page.

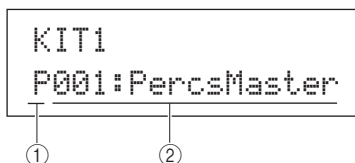

① **Kit category**

Use this parameter to specify either the Preset (P) or User (U) drum-kit category.

Settings	P or U
-----------------	--------

② **Kit number: Kit name**

Settings	With "P" (Preset kit) selected: 001 to 050 With "U" (User kit) selected: 001 to 200
-----------------	--

NOTE

- If you select a new drum kit while a pattern assigned to one of its pads is being played, the pattern will stop automatically.
- If you select a new drum kit while a preset voice or wave assigned to one of its pads is being played, the corresponding sound will be automatically silenced.
- If identical voices are assigned to the same Channel-10 MIDI note numbers in both the newly selected kit and the previous kit, it is normal for voices for the corresponding pads to continue to play when the new drum kit is selected.
- If any of the currently selected drum kit's pads are set to "Hand" on the Pad Type page (TRG2-1), the Hand icon (👐) will be displayed on-screen (see page 101).

KIT2 COMMON

Kit Volume, Tempo & Name

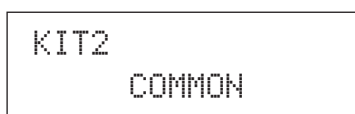

In the COMMON section, you can set the volume, tempo, and name of the currently selected drum kit. With the COMMON page (KIT2) displayed, press the [ENTER] button to access its three parameter-setting pages (KIT2-1 to KIT2-3). You can use the [<]/[>] buttons to navigate between these pages.

KIT2-1 Kit Volume page

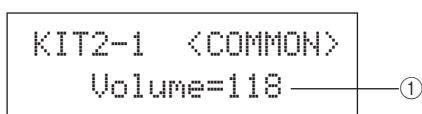

① **Volume**

Use this parameter to set the volume of the entire kit.

Settings	0 to 127
-----------------	----------

NOTE

- If you change the volume setting for MIDI channel 10 on the MIDI area's Volume page (MIDI3-2), the Volume parameter on this page (KIT2-1) will be automatically set to the same value. The reverse does not apply, however – in other words, the volume setting on the MIDI area's Volume page (MIDI3-2) is not affected by changes made on this page (KIT2-1).

KIT2-2 Kit Selection Tempo page

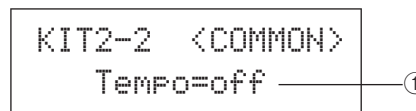

① **Tempo**

Use this parameter to specify the tempo to be set automatically upon selection of the current drum kit. If patterns are assigned to any of the kit's pads, they will be played at this tempo. An "off" setting means that the tempo will not change automatically when the current kit is selected – in other words, the tempo of the previously selected kit will be maintained.

Settings	off, or 30 to 300
-----------------	-------------------

NOTE

- If waves are assigned to any of the kit's pads, the tempo (or speed) at which they are played will not be affected by the kit's tempo setting.

KIT2-3 Kit Name page

From the Kit Name page, you can assign a name to the currently selected drum kit. With this page displayed, press the [ENTER] button to open the Kit Name Setting page.

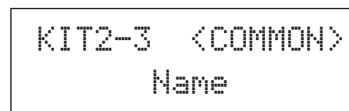

KIT2-3-1 Kit Name Setting page

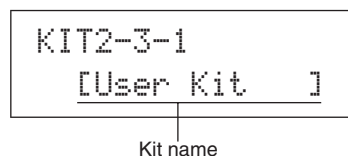

On the Kit Name Setting page, a name of up to 11 characters in length can be assigned to the currently selected drum kit. Use the [<]/[>] buttons to move the flashing cursor to the character you want to change, and then select a character using the [-/DEC] and [+/INC] buttons. The following characters can be used in drum-kit names.

[space]
!"#\$%&'()*+,-./0123456789:;<=>?@
ABCDEFGHIJKLMN O PQRSTU VWXYZ[\]^_`
abcdefghijklmnopqrstuvwxyz{|}~

Reference
KIT
VOICE
MIDI
WAVE
PATTERN
UTILITY
TRIGGER

KIT3 EFFECT SEND**Effect Send Levels**

```
KIT3
EFFECT SEND
```

In the EFFECT SEND section, you can adjust the degree to which chorus and reverb effects are applied to the entire drum kit. With the EFFECT SEND page (KIT3) displayed, press the [ENTER] button to access its two parameter-setting pages (KIT3-1 and KIT3-2). You can use the [**<**]/[**>**] buttons to switch between these pages.

KIT3-1 Chorus Send page

Using the Chorus Send page, you can adjust the degree to which the chorus effect is applied to all drum voices in the currently selected kit. If any of the kit's individual voices also have a chorus-send level set on the VOICE area's Chorus Send page (VCE4-2), chorus will be assigned to them in line with the sum of both send levels.

```
KIT3-1 <FXSEND>
ChorusSend= 0
```

① Chorus send level (ChorusSend)

Use this parameter to set the chorus-send level for the currently selected drum kit.

Settings	0 to 127
-----------------	----------

NOTE

- If you change the chorus-send level for MIDI channel 10 on the MIDI area's Chorus Send page (MIDI3-6), the ChorusSend parameter on this page (KIT3-1) will be automatically set to the same value. The reverse does not apply, however – in other words, the chorus send setting on the MIDI area's Chorus Send page (MIDI3-6) is not affected by changes made on this page (KIT3-1).

KIT3-2 Reverb Send page

Using the Reverb Send page, you can adjust the degree to which the reverb effect is applied to all drum voices in the currently selected kit. If any of the kit's individual voices also have a reverb-send level set on the VOICE area's Reverb Send page (VCE4-3), reverb will be assigned to them in line with the sum of both send levels.

```
KIT3-2 <FXSEND>
ReverbSend= 35
```

① Reverb send level (ReverbSend)

Use this parameter to set the reverb-send level for the currently selected drum kit.

Settings	0 to 127
-----------------	----------

NOTE

- If you change the reverb-send level for MIDI channel 10 on the MIDI area's Reverb Send page (MIDI3-7), the ReverbSend parameter on this page (KIT3-1) will be automatically set to the same value. The reverse does not apply, however – in other words, the reverb send setting on the MIDI area's Reverb Send page (MIDI3-7) is not affected by changes made on this page (KIT3-2).

KIT4 VARIATION**Variation Effect Setup**

```
KIT4
VARIATION
```

In the VARIATION section, you can select a variation effect, adjust the degree to which it is applied, and configure it in a number of other ways. Variation effects are applied to all voices (on all MIDI channels). With the VARIATION page (KIT4) displayed, press the [ENTER] button to access its five parameter-setting pages (KIT4-1 to KIT4-5). You can use the [**<**]/[**>**] buttons to navigate between these pages.

KIT4-1 Variation Type page

```
KIT4-1 VarType=
C&E/Compressor
```

① ②

① Variation category

Use this parameter to select a variation-effect category.

Settings	Refer to the separate Data List booklet.
-----------------	--

② Variation type

Use this parameter to select a variation-effect type.

Settings	Refer to the separate Data List booklet.
-----------------	--

With an effect category and type selected, you can press the [ENTER] button on the Variation Type page (KIT4-1) to access a range of setting pages allowing each of the selected effect's parameters to be set. (The number of parameter-setting pages depends on the effect selected.) Use the [**<**]/[**>**] buttons to navigate between these pages.

KIT4-1-1 Parameter setting page (example)

```
KIT4-1-1 <VAR>
LFOsFeed=0.000Hz
```

① Effect parameter

Each parameter setting page contains a different parameter for the selected variation effect.

Settings	Refer to the separate Data List booklet.
-----------------	--

KIT4-2 Variation Return page

```
KIT4-2  <VAR>
VarReturn= 64
```

① Variation return (VarReturn)

Use this parameter to set the level of the return signal from the variation effect.

Settings	0 to 127
----------	----------

KIT4-3 Variation Pan page

```
KIT4-3  <VAR>
VarPan= C
```

① Variation pan (VarPan)

Use this parameter to set the stereo panning of the variation effect's return signal.

Settings	L63 to C to R63
----------	-----------------

KIT4-4 Variation to Reverb page

```
KIT4-4  <VAR>
VarToRev= 0
```

① Variation to reverb (VarToRev)

Use this parameter to set the degree to which the output from the variation effect is sent to the reverb effect.

Settings	0 to 127
----------	----------

KIT4-5 Variation to Chorus page

```
KIT4-5  <VAR>
VarToCho= 0
```

① Variation to chorus (VarToCho)

Use this parameter to set the degree to which the output from the variation effect is sent to the chorus effect.

Settings	0 to 127
----------	----------

KIT5 CHORUS

Chorus Effect Setup

```
KIT5
CHORUS
```

In the CHORUS section, you can select a chorus effect and configure it in a range of different ways. Chorus effects are applied to all voices (on all MIDI channels). With the CHORUS page (KIT5) displayed, press the [ENTER] button to access its four parameter-setting pages (KIT5-1 to KIT5-4). You can use the [<]/[>] buttons to navigate between these pages.

KIT5-1 Chorus Type page

```
KIT5-1  ChoType=
G Chorus
```

① Chorus type

Use this parameter to select a chorus-effect type.

Settings	Refer to the separate Data List booklet.
----------	--

With a chorus type selected, you can press the [ENTER] button on the Chorus Type page (KIT5-1) to access a range of setting pages allowing each of its parameters to be set. (The number of parameter-setting pages depends on the type selected.) Use the [<]/[>] buttons to navigate between these pages.

KIT5-1-1 Parameter setting page (example)

```
KIT5-1-1 <CHO>
LFOSpeed=0.000Hz
```

① Effect parameter

Each parameter setting page contains a different parameter for the selected chorus type.

Settings	Refer to the separate Data List booklet.
----------	--

KIT5-2 Chorus Return page

```
KIT5-2  <CHO>
ChoReturn= 64
```

① Chorus return (ChoReturn)

Use this parameter to set the level of the return signal from the chorus effect.

Settings	0 to 127
----------	----------

KIT5-3 Chorus Pan page

```
KIT5-3    <CHO>
ChoPan= C
```

① Chorus pan (ChoPan)

Use this parameter to set the stereo panning of the chorus effect's return signal.

Settings	L63 to C to R63
----------	-----------------

KIT5-4 Chorus to Reverb page

```
KIT5-4    <CHO>
ChoToRev= 0
```

① Chorus to reverb (ChoToRev)

Use this parameter to set the degree to which the output from the chorus effect is sent to the reverb effect.

Settings	0 to 127
----------	----------

KIT6 REVERB

Reverb Effect Setup

```
KIT6
REVERB
```

In the REVERB section, you can select a reverb effect and configure it in a range of different ways. Reverb effects are applied to all voices (on all MIDI channels). With the REVERB page (KIT6) displayed, press the [ENTER] button to access its three parameter-setting pages (KIT6-1 to KIT6-3). You can use the [<]/[>] buttons to navigate between these pages.

KIT6-1 Reverb Type page

```
KIT6-1    RevType=
R3 Hall
```

① Reverb type

Use this parameter to select a reverb-effect type.

Settings	Refer to the separate Data List booklet.
----------	--

With a reverb type selected, you can press the [ENTER] button on the Reverb Type page (KIT6-1) to access a range of setting pages allowing each of its parameters to be set. (The number of parameter-setting pages depends on the type selected.) Use the [<]/[>] buttons to navigate between these pages.

KIT6-1-1 Parameter setting page (example)

```
KIT6-1-1  <REU>
RevTime= 0.0s
```

① Effect parameter

Each parameter setting page contains a different parameter for the selected reverb type.

Settings	Refer to the separate Data List booklet.
----------	--

KIT6-2 Reverb Return page

```
KIT6-2    <REU>
RevReturn= 64
```

① Reverb return (RevReturn)

Use this parameter to set the level of the return signal from the reverb effect.

Settings	0 to 127
----------	----------

KIT6-3 Reverb Pan page

```
KIT6-3    <REU>
RevPan= C
```

① Reverb pan (RevPan)

Use this parameter to set the stereo panning of the reverb effect's return signal.

Settings	L63 to C to R63
----------	-----------------

KIT7 OTHER

Other Drum Kit Settings

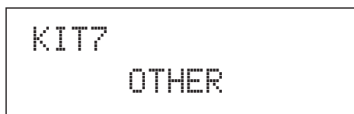

In the OTHER section, you can set parameters related to muting* and hi-hats, and you can also specify the trigger setup to be used when the current drum kit is selected. With the OTHER page (KIT7) displayed, press the [ENTER] button to access its six parameter-setting pages (KIT7-1 to KIT7-6). You can use the [<]/[>] buttons to navigate between these pages.

*: Muting

The action of pressing a hand down on a pad in order to change the sound it produces or to silence it is referred to as “muting”. This technique can be used to delicately change the sound of a performance, and with the DTX-MULTI 12, you can setup muting in advance in order to change or silence sounds when you press a hand down on a pad.

KIT7-1 Layer Switch page

Using the Layer Switch function, you can apply the muting technique during performances to switch between the four layers that can be assigned to built-in and external pads.

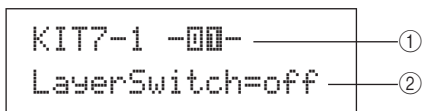

① **Pad number**

Use this parameter to select the pad to be set.

Settings	01 to 12, 13, 13R1, 13R2, 14 to 17
-----------------	------------------------------------

② **Layer switch**

Use this parameter to specify whether or not triggered layers from the pad indicated by ① are to be switched in response to muting or operation of a hi-hat controller. For more details regarding layers, see page 32.

- off..... Layers will not be switched.
- mute Layers A and B are played when muting is off.
 Layers C and D are played when muting is on.
- hh Layers A and B are played when the hi-hat is open.
 Layers C and D are played when the hi-hat is closed.

Settings	off, mute, or hh
-----------------	------------------

NOTE

- The “mute” setting is available only for the twelve built-in pads on your DTX-MULTI 12.

KIT7-2 Mute Switch page

On the Mute Switch page, you can select a group of pads to be treated as one in terms of muting in order to silence or change their sounds during performances.

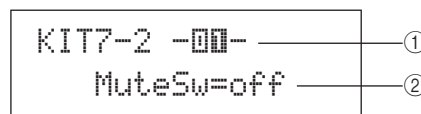

① **Pad number**

Settings	01 to 12
-----------------	----------

NOTE

- This parameter can be set only for the twelve built-in pads on your DTX-MULTI 12.

② **Mute switch (MuteSw)**

Set this parameter to “on” if muting for the pad indicated by ① is to operate in conjunction with muting for other pads with the same setting. When pad sensitivity is set for playing with sticks, we recommend that you set MuteSw to “on” for at least two pads so that you can use the muting technique without the fear of accidentally striking your hand. As you make your selections, the numbers in the Pad Indicator will light up to show which pads have been grouped together for muting.

Example: If MuteSw has been set to “on” for Pads 4, 5, and 6:

- When you strike Pad 4, 5, or 6 while pressing down on either of the other two pads by hand, the struck pad will produce a shorter sound.
- When you press down on Pad 4, 5, or 6 by hand while one or more of these pads are producing a sound as a result of being struck, the struck pad(s) will be silenced.

Settings	off or on
-----------------	-----------

NOTE

- Be sure to press firmly on a pad when you want to activate the muting function.
- If you are using the muting technique with the MuteSw parameter (② above) set to “on” and with “mute” selected on the Layer Switch page (KIT7-1), the Layer Switch function will be activated.
- A polyphonic aftertouch message with a value of 127 is output whenever you press down on a pad with MuteSw set to “on”. Similarly, a polyphonic aftertouch message with a value of 0 is output whenever you release the pad. These messages are output for note numbers assigned to all DTX-MULTI 12 pads, except those for which the mute switch is not enabled (i.e., MuteSw is set to “off”).
- In cases where pads 4 to 9 are setup for playing by hand on the TRIGGER area’s Pad Type page (TRG2-1), muting will be automatically activated without the need for multiple pads to have MuteSw turned on. In such a case, the pad with MuteSw turned on can be pressed and held in order to mute another struck pad. Note, however, that this type of single-pad muting cannot be activated for the other pads (1 to 3, 10 to 12).

Reference
KIT
VOICE
MIDI
WAVE
PATTERN
UTILITY
TRIGGER

KIT7-3 Hi-hat Function page

```
KIT7-3  <OTHER>
HH Func=hi-hat ①
```

① Hi-hat function (HH Func)

Use this parameter to specify how a hi-hat controller connected to the HI-HAT CONTROL jack is to function.

- hi-hat The hi-hat controller will function in the standard way for playing the hi-hat cymbal.
- MIDI..... When you step on the hi-hat controller, a MIDI message is output in line with the settings made on the Hi-hat MIDI Channel page (KIT7-4) and the Hi-hat MIDI Type page (KIT7-5).

Settings	hi-hat or MIDI
-----------------	----------------

NOTE

- When this parameter is set to "hi-hat" and "on" has been selected on the Send Hi-hat Controller page (UTIL5-3), Control Change 4 messages corresponding to the degree to which the hi-hat controller is depressed will be sent to external MIDI devices on MIDI channel 10.
- When this parameter is set to "MIDI", MIDI messages are sent regardless of the selection made on the Send Hi-hat Controller page (UTIL5-3).

KIT7-4 Hi-hat MIDI Channel page

```
KIT7-4  <OTHER>
HH MIDI ch=10 ①
```

① Hi-hat MIDI channel (HH MIDI ch)

If "MIDI" has been selected on the Hi-hat Function page (KIT7-3), use this parameter to set the MIDI channel for output of MIDI messages generated by the hi-hat controller.

Settings	1 to 16
-----------------	---------

NOTE

- If "hi-hat" has been selected on the Hi-hat Function page (KIT7-3), this setting will be displayed as "--" and modification will not be possible.

KIT7-5 Hi-hat MIDI Type page

```
KIT7-5  <OTHER>
HHMIDIType=CC01 ①
```

① Hi-hat MIDI type (HHMIDIType)

If "MIDI" has been selected on the Hi-hat Function page (KIT7-3), use this parameter to set the type of MIDI message generated by the hi-hat controller.

Settings	CC01 to CC95 (Control Change), AT (Aftertouch), PBup (Pitch bend up), or PBdwn (Pitch bend down)
-----------------	--

NOTE

- If "hi-hat" has been selected on the Hi-hat Function page (KIT7-3), this setting will be displayed as "----" and modification will not be possible.

KIT7-6 Trigger Setup Link page

```
KIT7-6  <OTHER>
TrgSetupLink=P01 ①
```

① Trigger setup link (TrgSetupLink)

Use this parameter to specify the trigger setup to be used when the current kit is selected. A trigger setup can be assigned to each different drum kit. These setups are identified using a category (P for Preset, U for User) and a number, and you can move the cursor using the [<]/[>] buttons to set these individually. Select "off" if the currently selected drum kit does not need a special trigger setup.

Settings	off, P01 to P05, or U01 to U10
-----------------	--------------------------------

NOTE

- If TrgSetupLink is set to "off", the trigger setup selected on the Startup Trigger page (UTIL1-5) will be loaded by default whenever the DTX-MULTI 12 is turned on. (See page 83.) Following this, the trigger setup can be freely changed on the Select Trigger Setup page (TRG1). (See page 100.)

KIT8 JOB

Kit Management



In the JOB section, you can perform a range of management tasks such as copying, swapping, and initializing of kits and pads. With the JOB page (KIT8) displayed, press the [ENTER] button to access its five parameter-setting pages (KIT8-1 to KIT8-5). You can use the [<]/[>] buttons to navigate between these pages.

Operations on the JOB section's parameter-setting pages are performed as follows.

- 1 **Make the required setting(s) and press the [ENTER] button.**
- 2 **You will be asked to confirm that you wish to proceed.**
- 3 **To do so, press the [ENTER] button. Alternatively, you can press the [EXIT] button to cancel the process.**

NOTE

- Use the [STORE] button to open the Store Kit page and save the drum kit in the DTX-MULTI 12's internal memory (see page 45). (This is not necessary when swapping kits on the Exchange Kit page (KIT8-3).)

KIT8-1 Copy Pad page

From the Copy Pad page, you can copy settings from one pad to another in the currently selected drum kit. With this page displayed, press the [ENTER] button to open the Copy Pad Settings page.

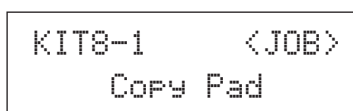

KIT8-1-1 Copy Pad Settings page

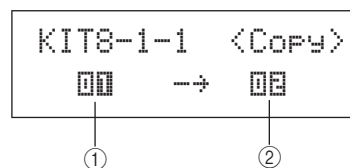

① Pad to be copied

Use this parameter to select the pad whose settings are to be copied.

Settings	01 to 12, 13, 13R1, 13R2, 14 to 17, FTSW (foot switch), HHCL (hi-hat close), or HHSP (hi-hat splash)
----------	--

② Pad to be replaced

Use this parameter to select the pad whose settings are to be replaced. Set to "01-12" to copy settings to all of the DTX-MULTI 12's built-in pads (i.e., Pad 1 to Pad 12). You can also set "all" to copy settings to all external pads (13, 13R1, 13R2, 14 to 17, FTSW, HHCL, and HHSP) in addition to all of the DTX-MULTI 12's built-in pads.

Settings	01 to 12, 13, 13R1, 13R2, 14 to 17, FTSW, HHCL, HHSP, 01 to 12, or all
----------	--

NOTE

- All information set for the pad in question and the corresponding layers (i.e., note numbers) will be copied.
- Certain factors may require that output MIDI note numbers other than those of the pad being copied are automatically assigned to the layers of the pad(s) being replaced. You can confirm which output MIDI note numbers have been set on the MIDI Note page (MIDI1-2).

KIT8-2 Exchange Pads page

From the Exchange Pads page, you can swap settings for a pair of pads within the currently selected kit. With this page displayed, press the [ENTER] button to open the Exchange Pads Settings page.

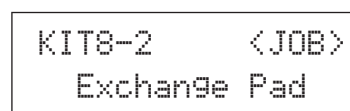

KIT8-2-1 Exchange Pads Settings page

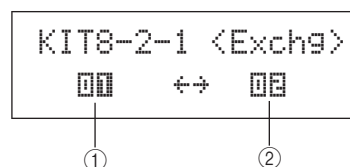

① Exchange pad 1

② Exchange pad 2

Use these parameters to select the two pads whose settings are to be swapped.

Settings	01 to 12, 13, 13R1, 13R2, 14 to 17, FTSW, HHCL, or HHSP
----------	---

KIT8-3 Exchange Kits page

From the Exchange Kits page, you can swap settings for a pair of User kits. With this page displayed, press the [ENTER] button to open the Exchange Kits Settings page.

```
KIT8-3    <JOB>
Exchange Kit
```

KIT8-3-1 Exchange Kits Settings page

```
KIT8-3-1 <Exchg>
U001 ↔ U002
```

① ②

① Exchange kit 1

② Exchange kit 2

Use these parameters to select the two drum kits whose settings are to be swapped.

Settings	U001 to U200
-----------------	--------------

NOTE

- Only those settings already stored will be swapped. In addition, if drum kits are swapped without first storing any modified settings, the swapped settings will be overwritten with the modified settings when the drum kit is subsequently stored.

KIT8-4 Initialize Pad page

From the Initialize Pad page, you can initialize individual pads from the currently selected drum kit. With this page displayed, press the [ENTER] button to open the Initialize Pad Setting page.

```
KIT8-4    <JOB>
Initialize Pad
```

KIT8-4-1 Initialize Pad Setting page

```
KIT8-4-1
InitPad=0000 — ①
```

① Pad number

Use this parameter to select the pad to be initialized.

Settings	01 to 12, 13, 13R1, 13R2, 14 to 17, FTSW, HHCL, or HHSP
-----------------	---

Once you have selected a pad, press the [ENTER] button, and when asked to confirm that you wish to proceed, press the [ENTER] button once again.

KIT8-5 Initialize Kit page

From the Initialize Kit page, you can initialize the drum kit currently being edited. With the Initialize Kit page displayed, press the [ENTER] button, and when asked to confirm that you wish to proceed, press the [ENTER] button once again.

```
KIT8-5    <JOB>
Initialize Kit
```

CAUTION

- When a kit is initialized, all of its parameters will be returned to their default settings. If you would like to save a copy of the kit before initialization, perform a Store operation as described on page 45 to store the currently selected drum kit as a different User kit.

VOICE Setting Area (VCE)

This section describes the VOICE setting area, which can be accessed using the [VOICE] button. In this area, you can select and edit the voices (i.e., preset voices, waves, and patterns) assigned to individual pads. For more information on voices and how they work, see page 31.

CAUTION

- Be sure to store any settings that you have edited before turning off the instrument or selecting a new kit. (See page 45.)

Makeup of VOICE Setting Area

The VOICE setting area is subdivided into five different sections (VCE1 to VCE5). Use the [**<**]/[**>**] buttons to navigate between these sections. If a section contains parameter-setting pages, the [ENTER] button will light up. Press the [ENTER] button to access these pages. You can press the [EXIT] button to move back towards the top of the setting area.

Changes made in the VOICE setting area affect the voices assigned to pads from the currently selected kit. You should, therefore, always select the drum kit you want to configure within the KIT setting area before entering the VOICE setting area. The top-most page within the VOICE setting area is the Select Voice page (VCE1), and here you can assign voices (i.e., preset voices, waves, and patterns) to individual pads and layers. On each of the parameter-setting pages within this area, furthermore, you can select the pad and/or layer to be modified. Please note that when you store changes made to parameters within the VOICE setting area, the entire drum kit is stored.

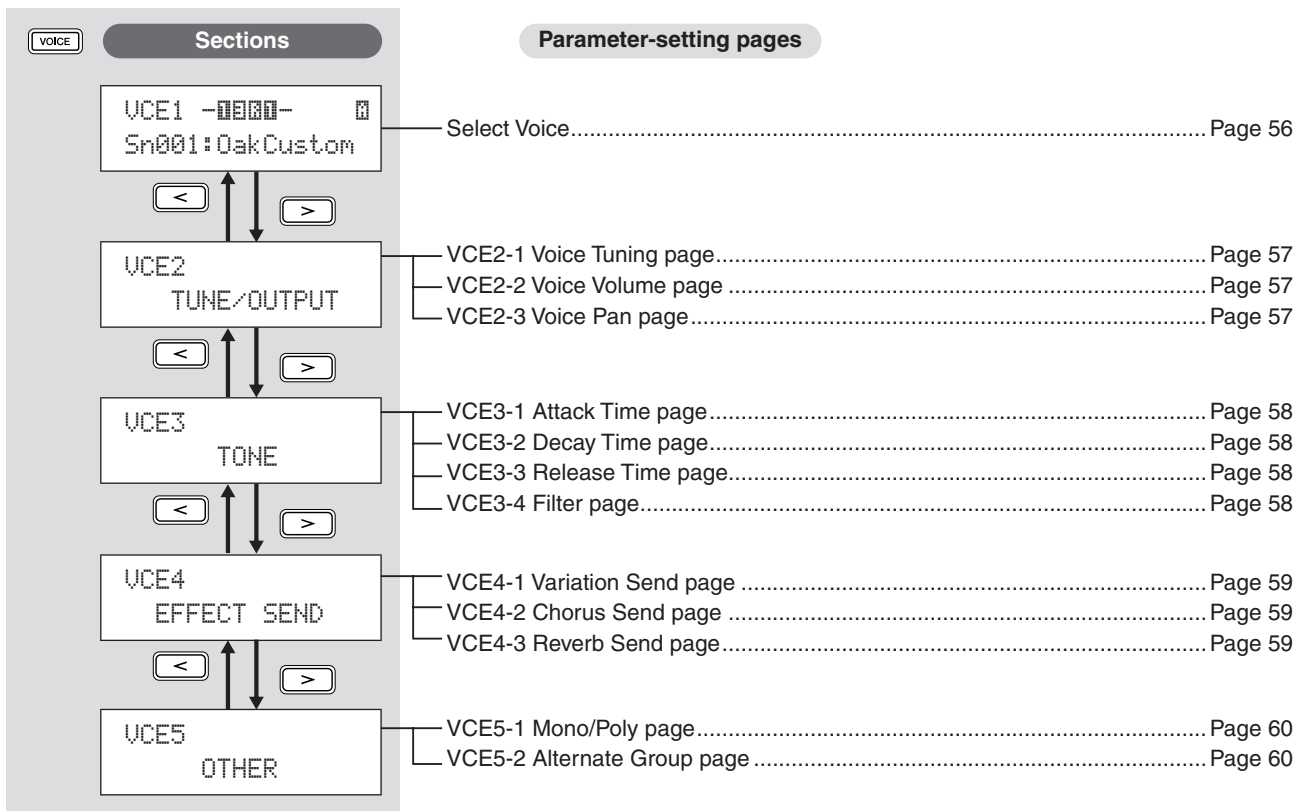

VCE1

Select Voice

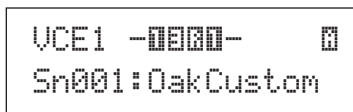

On the Select Voice page (VCE1), you can select the preset voice, wave, or pattern that will be played when the specified pad is struck. Alternatively, you can select a MIDI note to be played when a pad is struck, and then assign a voice to that MIDI note (see page 34). The applicable parameter-setting pages, parameters, and settings in the VOICE area will depend on whether a pad number or MIDI note number is specified.

NOTE

- Certain parameters have no effect when a pattern or a MIDI note number has been assigned to the pad in question. Their settings will be displayed as “---” and modification will not be possible.

Assigning a voice to a pad

If the voice is not a pattern (i.e., ♪P or ♪U)

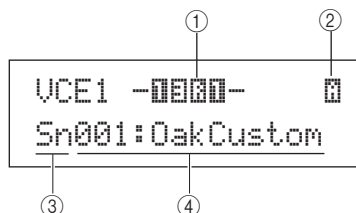

If the voice is a pattern (i.e., ♪P or ♪U)

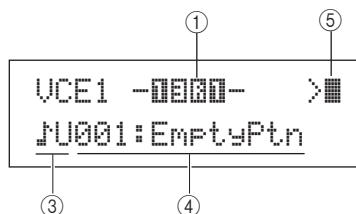

Assigning a voice to a MIDI note number

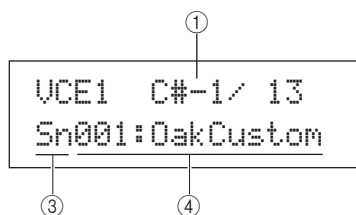

① Pad number

Use this parameter to select the number of the pad or MIDI note to be set. You can also strike a pad to select it.

Settings	01 to 12, 13, 13R1, 13R2, 14 to 17, FTSW (foot switch), HHCL (hi-hat close), HHSP (hi-hat splash), C#-1, or D-1 to A#5
-----------------	--

NOTE

- Pad 13 supports three different zones, and therefore, is assigned three different pad numbers – namely, 13 for the head, 13R1 for rim 1, and 13R2 for rim 2.
- Pads 10 to 12 cannot be selected if “disable” has been set on the Pad 10-12 Switch page (UTIL4-3).

② Layer number

Use this parameter to select the layer to be set. Each pad can contain up to four layers, each of which can be used to play a preset voice or wave. For details, see page 32.

Settings	A, B, C, or D
-----------------	---------------

NOTE

- The maximum number of layers that can be set for any pad is 4. To add a layer, change its setting on the MIDI Note page (MIDI1-2) from “off” to a MIDI note number.

③ Voice category

Use this parameter to specify the category of voice to be assigned as a preset voice, preset pattern (♪P), user pattern (♪U), or wave.

Settings	Kk, Sn, Tm, Cv, HH, EP, Cu, Br, In, Jp, Af, Or, E1, E2, E3, MI, GM, WV, ♪P, or ♪U
-----------------	---

NOTE

- Patterns cannot be assigned to MIDI note numbers.

④ Voice number: Voice name

Use these parameters to select a preset voice, pattern, or wave from the category indicated by ③.

Settings	Refer to the separate Data List booklet.
-----------------	--

⑤ Pattern playback mode

If a pattern has been assigned to the pad, use this parameter to specify how it will be played.

- > Start/stop mode: The pattern will start to play from the beginning when you strike the pad, and it will stop the next time you strike it.
- >■ Chase mode: One successive measure will be played each time you strike the pad.
- ■> Cut-off mode: Only one pattern set to this mode can play at any time. Whenever a cut-off mode pattern is triggered, any pattern already playing in this mode will be automatically stopped.

Settings	>, >■, ■>
-----------------	-----------

NOTE

- The maximum number of patterns that can play simultaneously is four.
- Demo patterns cannot be assigned to pads.

VCE2 TUNE/OUTPUT**Voice Tuning, Volume & Pan**

VCE2
TUNE/OUTPUT

In the TUNE/OUTPUT section, you can set the tuning, volume, and stereo panning of individual voices. With the TUNE/OUTPUT page (VCE2) displayed, press the [ENTER] button to access its three parameter-setting pages (VCE2-1 to VCE2-3). You can use the [<]/[>] buttons to navigate between these pages.

VCE2-1 Voice Tuning page

The parameters presented on the Voice Tuning page will depend on the type of voice assigned to the pad in question.

Drum sounds and waves (i.e., imported audio files):

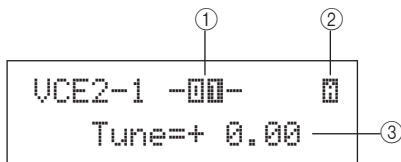

Instrument sounds (i.e., piano, guitar, etc.):

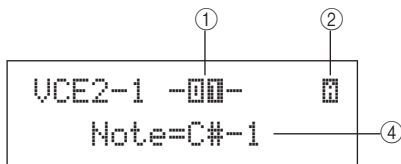

Patterns:

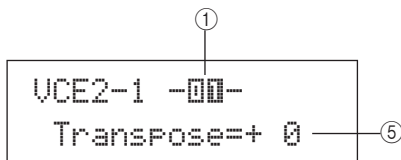
**① Pad number**

Use this parameter to select the number of the pad or MIDI note to be set.

Settings	01 to 12, 13, 13R1, 13R2, 14 to 17, FTSW (foot switch), HHCL (hi-hat close), HHSP (hi-hat splash), C#-1, or D-1 to A#5
-----------------	--

② Layer number

Use this parameter to select the layer to be set.

Settings	A, B, C, or D
-----------------	---------------

③ Tuning (Tune)

Use this parameter to adjust the tuning of the assigned voice in one-cent steps.

Settings	-24.00 to +0.0 to +24.00
-----------------	--------------------------

NOTE

- The term "cent" refers to one hundredth of a semitone (i.e., 100 cents = 1 semitone).

④ Note

Use this parameter to set the pitch of the assigned voice as a MIDI note number.

Settings	C-2 to G8
-----------------	-----------

⑤ Transpose

Use this parameter to adjust the pitch of the assigned pattern in one-semitone steps.

Settings	-24 to +0 to +24
-----------------	------------------

NOTE

- Patterns triggered using MIDI channels 7 to 11 cannot be transposed.

VCE2-2 Voice Volume page

On the Voice Volume page, you can set the volume of the selected voice.

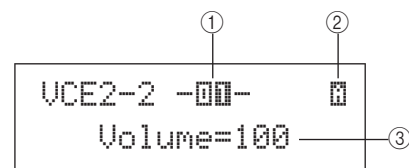
**① Pad number**

Settings	01 to 12, 13, 13R1, 13R2, 14 to 17, FTSW, HHCL, HHSP, C#-1, or D-1 to A#5
-----------------	---

② Layer number

Settings	A, B, C, or D
-----------------	---------------

③ Volume

Use this parameter to set the volume of the selected voice.

Settings	0 to 127
-----------------	----------

VCE2-3 Voice Pan page

On the Voice Pan page, you can set the stereo panning of the selected voice.

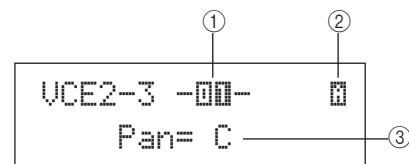
**① Pad number**

Settings	01 to 12, 13, 13R1, 13R2, 14 to 17, FTSW, HHCL, HHSP, C#-1, or D-1 to A#5
-----------------	---

② Layer number

Settings	A, B, C, or D
-----------------	---------------

③ Pan

Use this parameter to set the stereo panning of the selected voice.

Settings	L63 to C to R63
-----------------	-----------------

VCE3 TONE

Voice Timbre

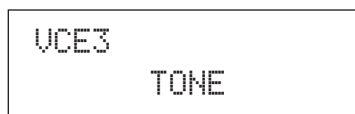

In the TONE section, you can adjust the tone (or timbre) of the preset voice, pattern, or wave assigned to the pad in question. With the TONE page (VCE3) displayed, press the [ENTER] button to access its four parameter-setting pages (VCE3-1 to VCE3-4). You can use the [<]/[>] buttons to navigate between these pages.

VCE3-1 Attack Time page

VCE3-2 Decay Time page

VCE3-3 Release Time page

On the Attack Time, Decay Time, and Release Time pages (VCE3-1 to VCE3-3), you can adjust the envelope of the assigned voice as shown below.

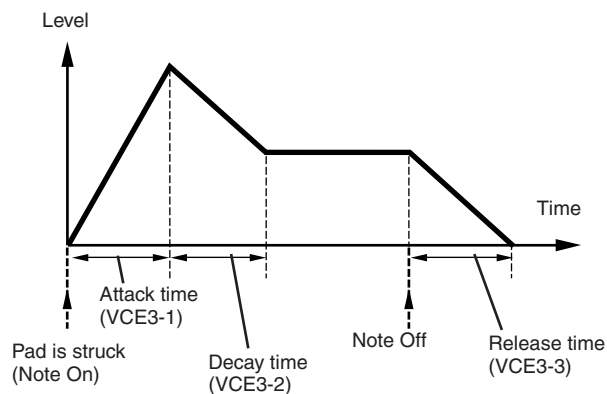

Parameter ③ from each of the pages is used to adjust a different part of the envelope. Parameters ① and ② below are identical on all three pages.

Typical Display for Attack Time (VCE3-1)

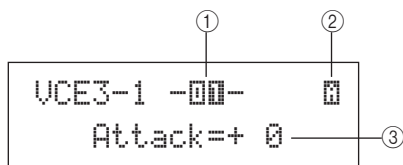

① Pad number

Settings	01 to 12, 13, 13R1, 13R2, 14 to 17, FTSW (foot switch), HHCL (hi-hat close), HHSP (hi-hat splash), C#-1, or D-1 to A#5
-----------------	--

② Layer number

Settings	A, B, C, or D
-----------------	---------------

Attack Time (VCE3-1)

③ Attack time

Use this parameter to set the amount of time it takes after the pad is struck for the assigned voice to reach its peak level.

Settings	-64 to +0 to +63
-----------------	------------------

Decay Time (VCE3-2)

③ Decay time

Use this parameter to set the amount of time it takes the voice to drop to a steady level after reaching its peak level.

Settings	-64 to +0 to +63
-----------------	------------------

Release Time (VCE3-3)

③ Release time

Use this parameter to set the amount of time it takes for the voice to fade out after sending a MIDI Note Off message.

Settings	-64 to +0 to +63
-----------------	------------------

NOTE

- MIDI Note Off messages are not sent for pads and layers for which "off" is selected on the MIDI area's Receive Key-Off page (MIDI1-5). Therefore, the release-time setting has no effect in such a case.

VCE3-4 Filter page

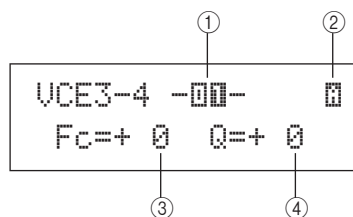

① Pad number

Settings	01 to 12, 13, 13R1, 13R2, 14 – 17, FTSW, HHCL, HHSP, C#-1, or D-1 to A#5
-----------------	--

② Layer number

Settings	A, B, C, or D
-----------------	---------------

③ Filter cutoff frequency (Fc)

Use this parameter to set a cutoff frequency for the low-pass filter. Frequencies above this level will be removed from the selected voice.

Settings	-64 to +0 to +63
-----------------	------------------

Low-pass filter

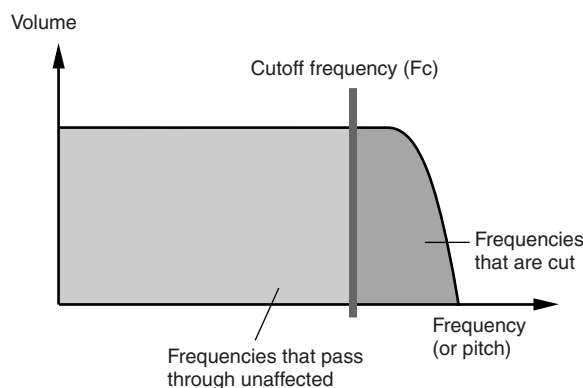

④ **Resonance (Q)**

Use this parameter to change the timbre of the voice by boosting frequencies around the cutoff frequency.

Settings	-64 to +0 to +63
-----------------	------------------

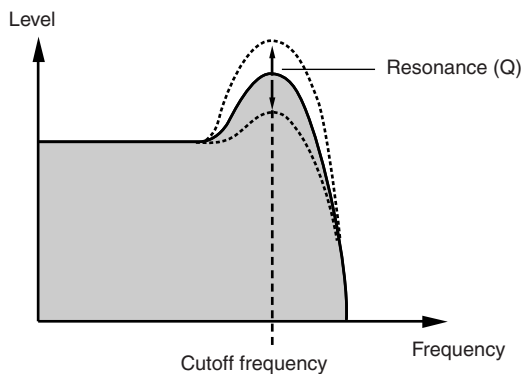

VCE4 EFFECT SEND

Effect Send Levels

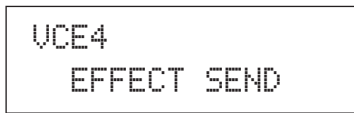

In the EFFECT SEND section, you can adjust the degree to which the DTX-MULTI 12's built-in Variation, Chorus, and Reverb effects are applied to individual voices. With the EFFECT SEND page (VCE4) displayed, press the [ENTER] button to access its three parameter-setting pages (VCE4-1 to VCE4-3). You can use the [\leftarrow]/[\rightarrow] buttons to navigate between these pages.

VCE4-1 Variation Send page

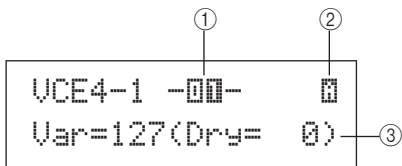

① **Pad number**

Settings	01 to 12, 13, 13R1, 13R2, 14 to 17, FTSW, HHCL, HHSP, C#-1, or D-1 to A#5
-----------------	---

② **Layer number**

Settings	A, B, C, or D
-----------------	---------------

③ **Variation send level (Var)**

Use this parameter to specify how much of the sound produced by the layer indicated by ② will be sent to the Variation effect.

Settings	0 to 127
-----------------	----------

VCE4-2 Chorus Send page

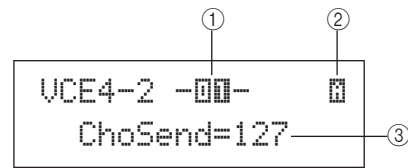

① **Pad number**

Settings	01 to 12, 13, 13R1, 13R2, 14 to 17, FTSW, HHCL, HHSP, C#-1, or D-1 to A#5
-----------------	---

② **Layer number**

Settings	A, B, C, or D
-----------------	---------------

③ **Chorus send level (ChoSend)**

Use this parameter to specify how much of the sound produced by the layer indicated by ② will be sent to the Chorus effect.

Settings	0 to 127
-----------------	----------

NOTE

- The chorus send level for the entire kit can be adjusted on the KIT area's Chorus Send page (KIT3-1).

VCE4-3 Reverb Send page

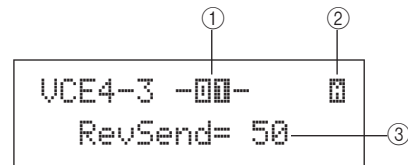

① **Pad number**

Settings	01 to 12, 13, 13R1, 13R2, 14 to 17, FTSW, HHCL, HHSP, C#-1, or D-1 to A#5
-----------------	---

② **Layer number**

Settings	A, B, C, or D
-----------------	---------------

③ **Reverb send level (RevSend)**

Use this parameter to specify how much of the sound produced by the layer indicated by ② will be sent to the Reverb effect.

Settings	0 to 127
-----------------	----------

NOTE

- The reverb send level for the entire kit can be adjusted on the KIT area's Reverb Send page (KIT3-2).

Reference

KIT

VOICE

MIDI

WAVE

PATTERN

UTILITY

TRIGGER

VCE5 OTHER

Other Voice-Related Settings

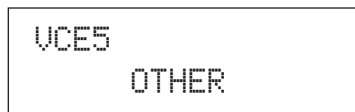

With the OTHER page (VCE5) displayed, press the [ENTER] button to access its two parameter-setting pages (VCE5-1 and VCE5-2). You can use the [<]/[>] buttons to switch between these pages.

VCE5-1 Mono/Poly page

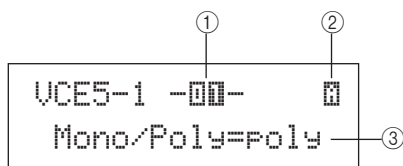

① **Pad number**

Settings	01 to 12, 13, 13R1, 13R2, 14 to 17, FTSW, HHCL, HHSP, C#-1, or D-1 to A#5
-----------------	---

② **Layer number**

Settings	A, B, C, or D
-----------------	---------------

③ **Mono/Poly**

Use this parameter to specify how overlapping sounds from the same pad or layer will be treated.

- mono..... When two overlapping sounds are produced by striking the same pad, the latter sound is given priority and the earlier sound is silenced.
- poly..... No such restriction is applied and all overlapping sounds are output.

Settings	mono or poly
-----------------	--------------

VCE5-2 Alternate Group page

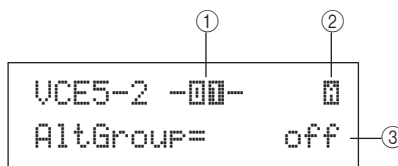

① **Pad number**

Settings	01 to 12, 13, 13R1, 13R2, 14 to 17, FTSW, HHCL, HHSP, C#-1, or D-1 to A#5
-----------------	---

② **Layer number**

Settings	A, B, C, or D
-----------------	---------------

③ **Alternate group (AltGroup)**

Using this parameter, you can assign voices to alternate groups (i.e., monophonic sets of pads, only one of which can be producing a sound at any time). If you do not want various individual voices to be played together, they should be assigned to the same alternate group. Whenever voices from the same alternate group are triggered by playing the instrument, the latter voice is given priority and the earlier sound is silenced. Set this parameter to “off” if you do not want to assign an alternate group.

Settings	off, hhOpen, hhClose, or 1 to 124
-----------------	-----------------------------------

NOTE

- The “hhOpen” and “hhClose” alternate groups operate in a special way: If a voice from the “hhClose” group is triggered after a voice from the “hhOpen” group, the hhOpen voice is silenced and only the hhClose voice is played. No silencing of the earlier sound is performed for any other triggering sequence (for example, hhOpen followed by hhOpen; hhClose followed by hhOpen; or hhClose followed by hhClose).

MIDI Setting Area (MIDI)

This section describes the MIDI setting area, which can be accessed using the [MIDI] button. In this area, you can set MIDI-related parameters on an individual-kit basis. In addition, layer settings for each pad (i.e., the number of layers and the way in which they play) are also configured within the MIDI setting area. For more information on the functions setup using this setting area, see page 34.

CAUTION

- Be sure to store any settings that you have edited before turning off the instrument or selecting a new kit. (See page 45.)

Structure of MIDI Setting Area

The MIDI setting area is subdivided into three different sections (MIDI1 to MIDI3). Use the [**<**]/[**>**] buttons to navigate between these sections. If a section contains parameter-setting pages, the [ENTER] button will light up. Press the [ENTER] button to access these pages. You can press the [EXIT] button to move back towards the top of the setting area. MIDI parameters set within this area are stored on an individual-kit basis; therefore, you should always select the drum kit you want to configure within the KIT setting area before entering the MIDI setting area. Parameters within the MIDI MESSAGE section (MIDI1) affect individual pads, which can be selected on-screen or by striking them. Meanwhile, parameters within the TG/MIDI SWITCH section (MIDI2) and the OTHER section (MIDI3) affect individual MIDI channels, which can be selected on-screen.

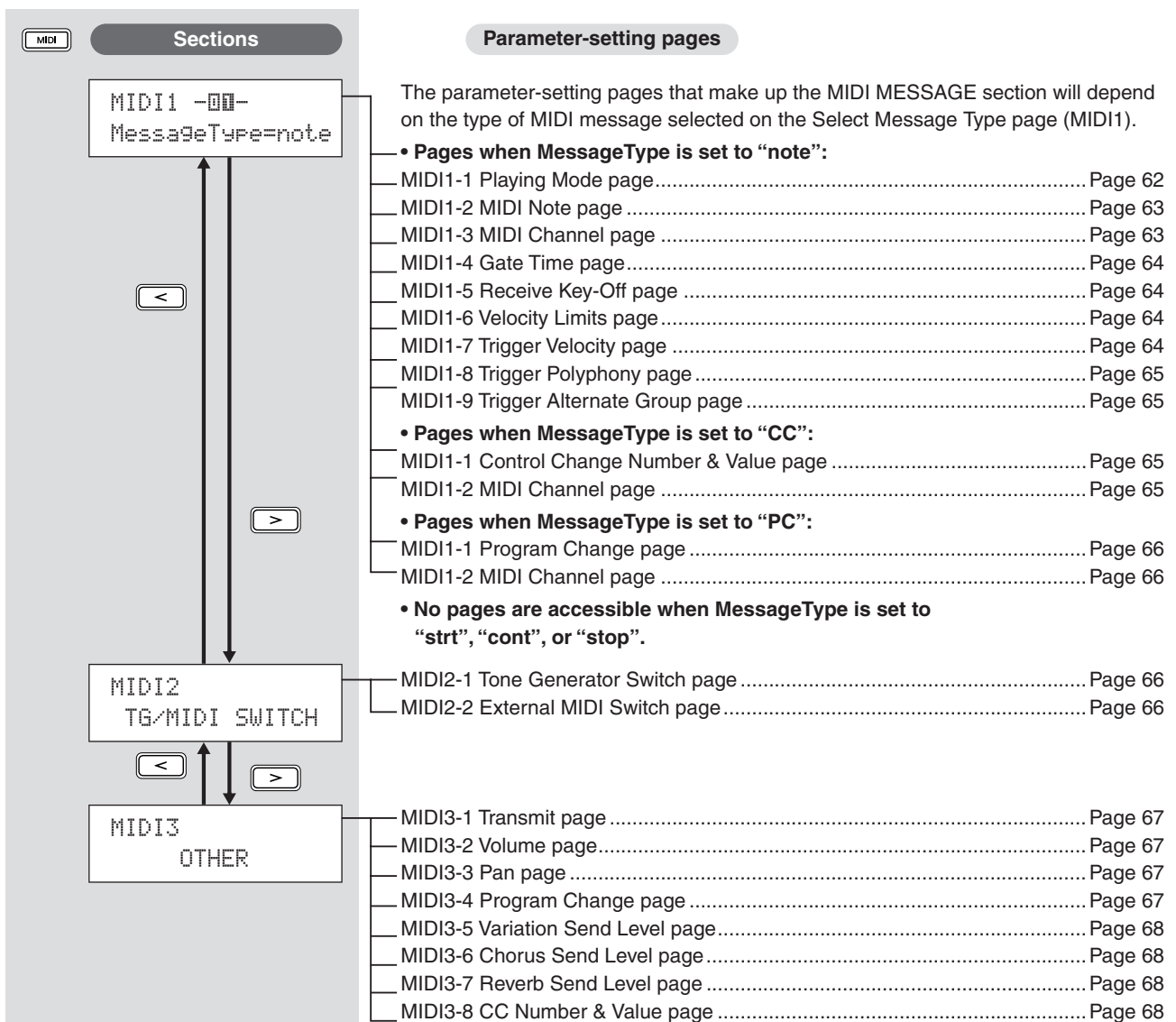

MIDI1

Select Message Type

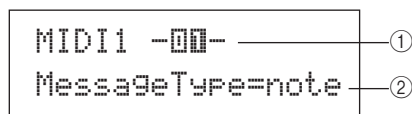

When you press the [MIDI] button, a page for selecting a MIDI message type (MIDI1) will be displayed. On this page, you can select the type of MIDI message to be assigned to each pad.

① Pad number

Use this parameter to select the pad to be set. You can also strike a pad to select it.

Settings	01 to 12, 13, 13R1, 13R2, 14 to 17, FTSW (foot switch), HHCL (hi-hat close), or HHSP (hi-hat splash)
----------	--

② Message type

Use this parameter to set the type of MIDI message that will be sent whenever the pad indicated by ① is struck.

- note A MIDI note will be sent. Use this setting if you want to produce a sound whenever you strike the pad.
- CC A Control Change message will be sent.
- PC A Program Change message will be sent.
- strt A SysEx FA Start command will be sent.
- cont A SysEx FB Continue command will be sent.
- stop A SysEx FC Stop command will be sent.

Settings	note, CC, PC, strt, cont, or stop
----------	-----------------------------------

NOTE

- “note” type messages are sent simultaneously to the DTX-MULTI 12’s internal tone generator and to connected external MIDI devices.
- Message types other than “note” are sent only to connected external MIDI devices.

The parameter-setting pages that can be accessed within the MIDI1 section will depend on the type of MIDI message selected.

- Parameter-setting pages for “note” messages are explained on this page.

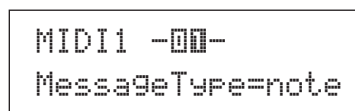

- Parameter-setting pages for “CC” messages are explained on page 65.

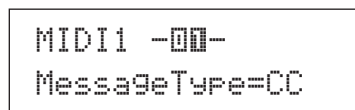

- Parameter-setting pages for “PC” messages are explained on page 66.

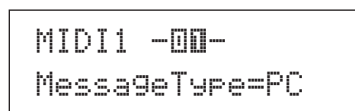

Parameter-Setting Pages for “note” Messages

MIDI1-1 Playing Mode page

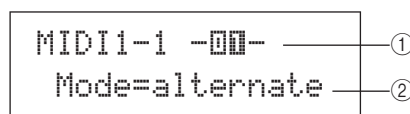

① Pad number

Settings	01 to 12, 13, 13R1, 13R2, 14 to 17, FTSW, HHCL, or HHSP
----------	---

② Playing mode

Use this parameter to set Stack, Alternate, or Hold as the playing mode for the pad indicated by ①. Some typical applications of these modes are explained on the following page.

- stack When Stack mode is selected, all notes assigned to the pad are triggered simultaneously. For example, you can use this mode to produce chords or to trigger multiple preset voices or waves with a single strike. To produce just one sound, select this mode and assign only one voice to the pad.
- alternate.... When Alternate mode is selected, the notes assigned to the pad are played individually in turn each time it is struck. For example, you can use this mode to produce a different sound each time you strike the pad.
- hold When Hold mode is selected, the notes assigned to the pad are alternately turned on and off each time it is struck. If, for example, a sustained sound has been assigned, the first strike of the pad will turn it on, the next strike will turn it off, and so on.

Settings	stack, alternate, or hold
----------	---------------------------

NOTE

- If no note numbers have been assigned to any of the pad’s layers (A to D) on the MIDI Note page (MIDI1-2), this setting will be displayed as “-” and modification will not be possible.

Typical Uses of Stack, Alternate, and Hold Modes

Using the Playing Mode page (MIDI1-1), you can select the way in which a pad's four layers will be played. For example, pads can be setup to produce a chord by playing multiple layers at the same time or to play a different layer on each successive strike. The following are typical examples of how these modes can be used.

● Playing just one sound when a pad is struck

Select "stack" on the Playing Mode page (MIDI1-1), and assign a MIDI note to Layer A only on the MIDI Note page (MIDI1-2).

Layer	Note number
A	D1
B	off
C	off
D	off

● Playing two sounds simultaneously when a pad is struck

Select "stack" on the Playing Mode page (MIDI1-1), and assign a different MIDI note to both Layer A and Layer B on the MIDI Note page (MIDI1-2).

Layer	Note number
A	D1
B	E2
C	off
D	off

● Playing two sounds alternately each time a pad is struck

Select "alternate" on the Playing Mode page (MIDI1-1), and assign a different MIDI note to Layers A and B on the MIDI Note page (MIDI1-2).

Layer	Note number
A	D1
B	E2
C	off
D	off

● Playing Layer A, then silencing it, playing Layer C, then silencing it, playing Layer A... and so on each time a pad is struck

Select "alternate" on the Playing Mode page (MIDI1-1), and assign a MIDI note or "skip" to Layers A through D on the MIDI Note page (MIDI1-2) as follows.

Layer	Note number
A	D1
B	skip
C	E2
D	skip

● Playing three held sounds simultaneously when a pad is struck, and silencing them the next time it is struck

Select "hold" on the Playing Mode page (MIDI1-1), and assign MIDI notes to Layers A through C on the MIDI Note page (MIDI1-2) as follows. In addition, select "on" for Layers A through C on the Receive Key-Off page (MIDI1-5).

Layer	Note number
A	C3
B	E3
C	G3
D	off

NOTE

- If a note on MIDI channel 10 is assigned, be sure to select "on" for Layers A through C on the Receive Key-Off page (MIDI1-5).

MIDI1-2 MIDI Note page

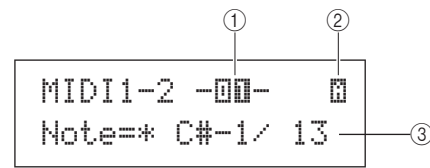

① Pad number

Settings	01 to 12, 13, 13R1, 13R2, 14 to 17, FTSW, HHCL, or HHSP
----------	---

② Layer number

Use this parameter to select the layer you want to set.

Settings	A, B, C, or D
----------	---------------

③ Note

Use this parameter to select a MIDI note to be sent by the layer indicated by ②. You can also choose either of the following two special settings.

- off.....Regardless of the setting made on the Playing Mode page (MIDI1-1), no MIDI note will be sent when the pad is struck.
- skip.....If "alternate" has been selected on the Playing Mode page (MIDI1-1), this layer will be skipped. In other words, no MIDI note will be sent when it is this layer's turn to play. Alternatively, if "stack" or "hold" has been set on the Playing Mode page (MIDI1-1), this setting has the same effect as "off" above (i.e., no MIDI note will be sent for this layer).

Settings	off, C#-2/1 to F#8/126, or skip
----------	---------------------------------

NOTE

- Notes outside the range covered by General MIDI are displayed in parentheses – for example, "(C#-2/1)".
- Notes on MIDI channel 10 having already been assigned to a layer will be displayed with an asterisk in front of them – for example, "*C3". If you change the note setting for a pad indicated in this way, the note setting for the other pad will also be changed in the same way.

MIDI1-3 MIDI Channel page

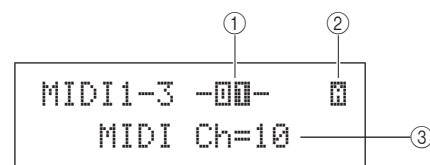

① Pad number

Settings	01 to 12, 13, 13R1, 13R2, 14 to 17, FTSW, HHCL, or HHSP
----------	---

② Layer number

Settings	A, B, C, or D
----------	---------------

③ MIDI channel (MIDI Ch)

Use this parameter to set the MIDI channel for MIDI notes sent for the layer indicated by ②.

Settings	1 to 16
----------	---------

NOTE

- If no note number has been assigned to any of the pad's layers (A to D) on the MIDI Note page (MIDI1-2), this setting will be displayed as "--" and modification will not be possible.

MIDI1-4 Gate Time page

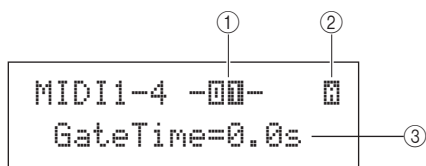

① Pad number

Settings	01 to 12, 13, 13R1, 13R2, 14 to 17, FTSW, HHCL, or HHSP
----------	---

② Layer number

Settings	A, B, C, or D
----------	---------------

③ Gate time

Use this parameter to set a gate time for MIDI notes sent for the layer indicated by ②. A MIDI Note On message is sent when a pad is struck, and the corresponding Note Off message is sent a short time later. The duration between sending of these signals is referred to as the “gate time”, and by adjusting this setting, you can control the duration of MIDI notes.

Settings	0.0s to 9.9s
----------	--------------

NOTE

- If no note numbers have been assigned to any of the pad's layers (A to D) on the MIDI Note page (MIDI1-2), this setting will be displayed as “--” and modification will not be possible.
- If “hold” has been selected on the Playing Mode page (MIDI1-1), this setting will be displayed as “---” and modification will not be possible.
- MIDI Note Off signals are not sent for pads set to “off” on the Receive Key-Off page (MIDI1-5). If you want to set a gate time, therefore, be sure to set RcvKeyOff to “on”.

MIDI1-5 Receive Key-Off page

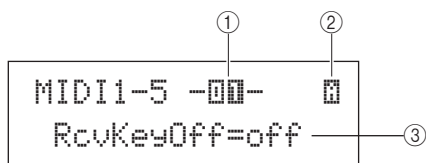

① Pad number

Settings	01 to 12, 13, 13R1, 13R2, 14 to 17, FTSW, HHCL, or HHSP
----------	---

② Layer number

Settings	A, B, C, or D
----------	---------------

③ Receive key-off (RcvKeyOff)

Use this parameter to set whether or not MIDI Note Off messages will be sent for the layer indicated by ②. Most drum voices are one-shot sounds that decay over time until they become silent; therefore, MIDI Note Off messages are not needed to stop them. As such, this parameter should normally be set to “off”. If, however, a non-decaying sound is assigned to a pad or layer, you can ensure that the required MIDI Note Off message is sent by setting this parameter to “on”. In addition, you can adjust the amount of time that passes between striking of the pad and sending MIDI Note Off messages using the Gate Time page (MIDI1-4).

Settings	off or on
----------	-----------

NOTE

- If no note numbers have been assigned to any of the pad's layers (A to D) on the MIDI Note page (MIDI1-2), this setting will be displayed as “--” and modification will not be possible.
- Sending of MIDI Note Off messages is automatically turned on whenever a MIDI Channel other than 10 has been selected on the MIDI Channel page (MIDI1-3). In such a case, therefore, this setting will be displayed as “---” and modification will not be possible.

MIDI1-6 Velocity Limits page

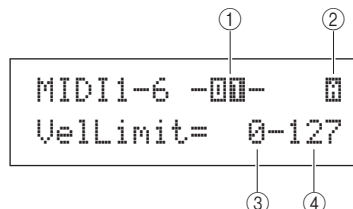

① Pad number

Settings	01 to 12, 13, 13R1, 13R2, 14 to 17, FTSW, HHCL, or HHSP
----------	---

② Layer number

Settings	A, B, C, or D
----------	---------------

③ Velocity lower limit

④ Velocity upper limit

Use these parameters to set the range of velocities that will cause the layer indicated by ② to send a MIDI note message. The term “velocity” refers to the speed (or power) with which a pad is struck. By setting upper and lower limits using these parameters, you can prevent sounds from being produced when the pad is struck too hard or too soft.

Settings	0 to 127
----------	----------

NOTE

- If no note numbers have been assigned to any of the pad's layers (A to D) on the MIDI Note page (MIDI1-2), these settings will be displayed as “---” and modification will not be possible.

MIDI1-7 Trigger Velocity page

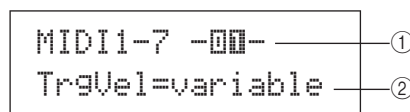

① Pad number

Settings	01 to 12, 13, 13R1, 13R2, 14 to 17, FTSW, HHCL, or HHSP
----------	---

② Trigger velocity (TrgVel)

Use this parameter to control the velocity value of MIDI notes to be sent whenever the pad indicated by ① is struck.

- variable..... MIDI velocity values will reflect the strength with which the pad is struck.
- 1 – 127..... MIDI notes are sent with this fixed velocity value, regardless of how hard or soft the pad is struck.

Settings	variable or 1 to 127
----------	----------------------

NOTE

- If no note numbers have been assigned to any of the pad's layers (A to D) on the MIDI Note page (MIDI1-2), this setting will be displayed as “--” and modification will not be possible.
- No sound will be produced if TrgVel ② is set to a value outside the limits set on the Velocity Limits page (MIDI1-6).

MIDI1-8 Trigger Polyphony page

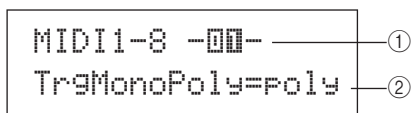

① Pad number

Settings	01 to 12, 13, 13R1, 13R2, 14 to 17, FTSW, HHCL, or HHSP
----------	---

② Trigger mono/poly (TrgMonoPoly)

Use this parameter to control what happens when the pad indicated by ① is struck repeatedly.

- mono The previous sound will be stopped before a new sound starts.
- poly Previous sounds will continue to play when a new sound starts.

Settings	mono or poly
----------	--------------

NOTE

- If no note numbers have been assigned to any of the pad's layers (A to D) on the MIDI Note page (MIDI1-2), this setting will be displayed as "--" and modification will not be possible.
- MIDI Note Off messages are not sent when "off" has been selected on the Receive Key-Off page (MIDI1-5). If you want to set trigger monophony, therefore, be sure to set this parameter to "on". This will ensure that Note Off messages are sent to prevent overlapping voices.

MIDI1-9 Trigger Alternate Group page

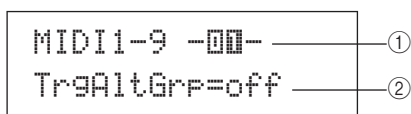

① Pad number

Settings	01 to 12, 13, 13R1, 13R2, 14 to 17, FTSW, HHCL, or HHSP
----------	---

② Trigger alternate group (TrgAltGrp)

Use this parameter to assign the pad indicated by ① to an alternate group if so required. Alternate groups are monophonic sets of pads, and therefore, only one pad from an alternate group can be producing a sound at any time. If a pad is struck while another pad from the same alternate group is already producing a sound, a MIDI Note Off message will be sent for the first pad together with the MIDI Note On message for the second. In order to use trigger alternate groups with voices played on MIDI channel 10, the sending of MIDI Note Off messages must be enabled by selecting "on" for RcvKeyOff on the Receive Key-Off page (MIDI1-5). Up to 32 trigger alternate groups can be setup on your DTX-MULTI 12. If there is no need for a pad to be assigned to a trigger alternate group, you can set this parameter to "off".

Settings	off or 1 to 32
----------	----------------

NOTE

- If no note numbers have been assigned to any of the pad's layers (A to D) on the MIDI Note page (MIDI1-2), this setting will be displayed as "--" and modification will not be possible.
- MIDI Note Off messages are not sent when "off" has been set on the Receive Key-Off page (MIDI1-5). If you want to use trigger alternate groups, therefore, be sure to set this parameter to "on". This will ensure that Note Off messages are sent to prevent overlapping voices.

Parameter-Setting Pages for "CC" Messages

MIDI1-1 Control Change Number & Value page

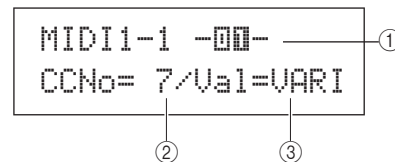

① Pad number

Settings	01 to 12, 13, 13R1, 13R2, 14 to 17, FTSW, HHCL, or HHSP
----------	---

② Control change number (CCNo)

Use this parameter to set the type of MIDI Control Change message to be sent whenever the pad indicated by ① is struck.

Settings	1 to 95
----------	---------

③ Control change value (Val)

Use this parameter to set a value for the MIDI Control Change message to be sent whenever the pad indicated by ① is struck.

- VARI The control change value will depend on how hard the pad is struck.
- 0 – 127 Control change messages are sent with this fixed value, regardless of how hard or soft the pad is struck.

Settings	VARI or 0 to 127
----------	------------------

NOTE

- Before setting Val ③ to "VARI", it will be necessary to access the Trigger Velocity page (MIDI1-7) with Message Type=note (MIDI1) and to set the TrgVel parameter to "variable".

MIDI1-2 MIDI Channel page

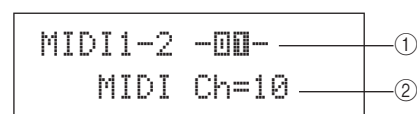

① Pad number

Settings	01 to 12, 13, 13R1, 13R2, 14 to 17, FTSW, HHCL, or HHSP
----------	---

② MIDI channel (MIDI Ch)

Use this parameter to set a MIDI channel for the Control Change messages to be sent whenever the pad indicated by ① is struck.

Settings	1 to 16
----------	---------

Parameter-Setting Pages for "PC" Messages

MIDI1-1 Program Change page

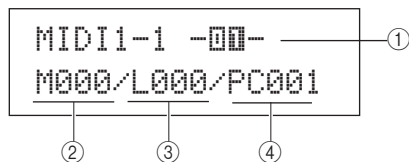

① Pad number

Settings	01 to 12, 13, 13R1, 13R2, 14 to 17, FTSW, HHCL, or HHSP
----------	---

② Bank select MSB (M)

Use this parameter to set a bank-select MSB value to be sent whenever the pad indicated by ① is struck.

Settings	000 to 127
----------	------------

③ Bank select LSB (L)

Use this parameter to set a bank-select LSB value to be sent whenever the pad indicated by ① is struck.

Settings	000 to 127
----------	------------

④ Program change (PC)

Use this parameter to set a program-change number to be sent whenever the pad indicated by ① is struck.

Settings	001 to 128
----------	------------

MIDI1-2 MIDI Channel page

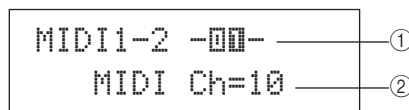

① Pad number

Settings	01 to 12, 13, 13R1, 13R2, 14 to 17, FTSW, HHCL, or HHSP
----------	---

② MIDI channel (MIDI Ch)

Use this parameter to set the MIDI channel for the program-change messages to be sent whenever the pad indicated by ① is struck.

Settings	1 to 16
----------	---------

MIDI2 TG/MIDI SWITCH

MIDI Destination Switches

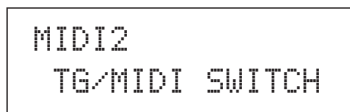

With the TG/MIDI SWITCH page (MIDI2) displayed, press the [ENTER] button to access its two parameter-setting pages (MIDI2-1, MIDI2-2). You can use the [<]/[>] buttons to switch between these pages.

MIDI2-1 Tone Generator Switch page

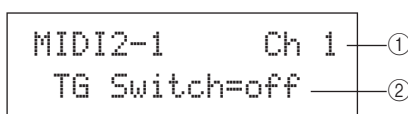

① MIDI channel (Ch)

Use this parameter to select the MIDI channel (1 to 16) to be set.

Settings	1 to 16
----------	---------

② Tone generator switch (TGSwitch)

Use this parameter to indicate whether MIDI messages produced by playing pads and changing drum kits should be sent to the internal tone generator. (Choose "on" to send to the tone generator.)

Settings	off or on
----------	-----------

MIDI2-2 External MIDI Switch page

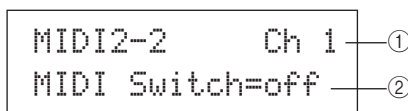

① MIDI channel (Ch)

Use this parameter to select the MIDI channel (1 to 16) to be set.

Settings	1 to 16
----------	---------

② External MIDI switch (MIDI Switch)

Use this parameter to indicate whether MIDI messages produced by playing pads and changing drum kits should be sent to an external tone generator via the MIDI OUT connector on the rear panel or the USB TO HOST port on the side panel. (Choose "on" to send the messages.)

Settings	off or on
----------	-----------

MIDI3 OTHER

Other MIDI Settings

```
MIDI3
  OTHER
```

In the OTHER section, you can set various MIDI messages to be sent whenever the current kit is selected. With the OTHER page (MIDI3) displayed, press the [ENTER] button to access its eight parameter-setting pages (MIDI3-1 through MIDI3-8). You can use the [<]/[>] buttons to navigate between these pages.

MIDI3-1 Transmit page

```
MIDI3-1  Ch 1
  Transmit=all
```

① MIDI channel (Ch)

Use this parameter to select the MIDI channel (1 to 16) to be set.

Settings	1 to 16
----------	---------

② Transmit

Use this parameter to indicate which MIDI messages are to be sent whenever the current kit is selected.

- off..... No MIDI messages will be sent.
- all..... All applicable MIDI messages will be sent. (See the following parameter-setting page descriptions for more details.)
- PC..... Only program change messages and bank-select MSB/LSB messages will be sent.

Settings	off, all, or PC
----------	-----------------

MIDI3-2 Volume page

```
MIDI3-2  Ch 1
  Volume=100
```

① MIDI channel (Ch)

Settings	1 to 16
----------	---------

② Volume

Use this parameter to set a volume value to be sent whenever the current kit is selected.

Settings	0 to 127
----------	----------

NOTE

- If "off" or "PC" has been selected on the Transmit page (MIDI3-1), this setting will be displayed as "---" and modification will not be possible.

MIDI3-3 Pan page

```
MIDI3-3  Ch 1
  Pan= C
```

① MIDI channel (Ch)

Settings	1 to 16
----------	---------

② Pan

Use this parameter to set the pan value to be sent whenever the current kit is selected.

Settings	L63 to C to R63
----------	-----------------

NOTE

- If "off" or "PC" has been selected on the Transmit page (MIDI3-1), this setting will be displayed as "---" and modification will not be possible.

MIDI3-4 Program Change page

```
MIDI3-4  Ch 1
  M000/L000/PC001
```

① MIDI channel (Ch)

Settings	1 to 16
----------	---------

② Bank select MSB (M)

Use this parameter to set a bank-select MSB value to be sent whenever the current kit is selected.

Settings	000 to 127
----------	------------

③ Bank select LSB (L)

Use this parameter to set a bank-select LSB value to be sent whenever the current kit is selected.

Settings	000 to 127
----------	------------

④ Program change (PC)

Use this parameter to set a program-change number to be sent whenever the current kit is selected.

Settings	001 to 128
----------	------------

NOTE

- If "off" has been selected on the Transmit page (MIDI3-1), these settings will be displayed as "---" and modification will not be possible.

MIDI3-5 Variation Send Level page**MIDI3-6 Chorus Send Level page****MIDI3-7 Reverb Send Level page**

On the Variation Send Level, Chorus Send Level, and Reverb Send Level pages, you can adjust the send level to be set for each of the corresponding effect units when the current kit is selected.

NOTE

- If "off" or "PC" has been selected on the Transmit page (MIDI3-1), these settings will be displayed as "---" and modification will not be possible.

Parameter ② from each of the pages is used to adjust the corresponding send level. Parameter ① is identical on all three pages.

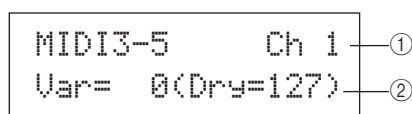
[Setting example using the Variation Send Level page (MIDI3-5)]**① MIDI channel (Ch)**

Settings	1 to 16
-----------------	---------

[MIDI3-5 Variation Send Level page]**② Variation send level (Var)**

Use this parameter to set the variation-effect send level to be sent whenever the current kit is selected.

Settings	0 to 127
-----------------	----------

NOTE

- If the MIDI channel ① is set to 10, this setting will be displayed as "---" and modification will not be possible.

[MIDI3-6 Chorus Send Level page]**② Chorus send level (ChoSend)**

Use this parameter to set the chorus send level to be sent whenever the current kit is selected.

Settings	0 to 127
-----------------	----------

[MIDI3-7 Reverb Send Level page]**② Reverb send level (RevSend)**

Use this parameter to set the reverb send level to be sent whenever the current kit is selected.

Settings	0 to 127
-----------------	----------

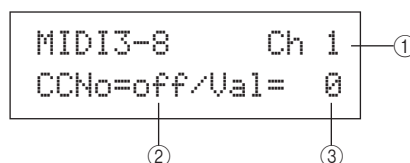
MIDI3-8 CC Number & Value page**① MIDI channel (Ch)**

Settings	1 to 16
-----------------	---------

② Control change number (CCNo)

Use this parameter to set the type (or number) of MIDI Control Change message to be sent whenever the current kit is selected. No control-change messages are sent when "off" is set.

Settings	off or 1 to 95
-----------------	----------------

③ Control change value (Val)

Use this parameter to set a value for the MIDI Control Change messages to be sent whenever the current kit is selected.

Settings	0 to 127
-----------------	----------

NOTE

- If "off" or "PC" has been selected on the Transmit page (MIDI3-1), these settings will be displayed as "---" and modification will not be possible.
- If the type of MIDI Control Change message set on this page (MIDI3-8) matches one of the control-change message types set on the following pages, this page's setting will have priority: Volume (MIDI3-2), Pan (MIDI3-3), Variation Send Level (MIDI3-5), Chorus Send Level (MIDI3-6), or Reverb Send Level (MIDI3-7).

WAVE Setting Area (WAVE)

This section describes the WAVE setting area, which can be accessed using the [WAVE] button. Your DTX-MULTI 12 can be used to import AIF and WAV audio files from a wide range of sources. These files (referred to as “waves”) can then be used in the same way as the instrument’s preset voices and patterns. The WAVE setting area is used to import and edit waves.

⚠ CAUTION

- Be sure to store any imported waves or settings that you have edited before turning off the instrument or selecting a new wave. (See page 45.)

Makeup of WAVE Setting Area

The following four sections (WAVE1 to WAVE4) make up the WAVE setting area. Use the [<]/[>] buttons to navigate between these sections. If a section contains parameter-setting pages, the [ENTER] button will light up. Press the [ENTER] button to access these pages. In certain cases, a number of additional pages may be accessed from a parameter setting page, also using the lit [ENTER] button. Furthermore, you can press the [EXIT] button to move back towards the top of the setting area.

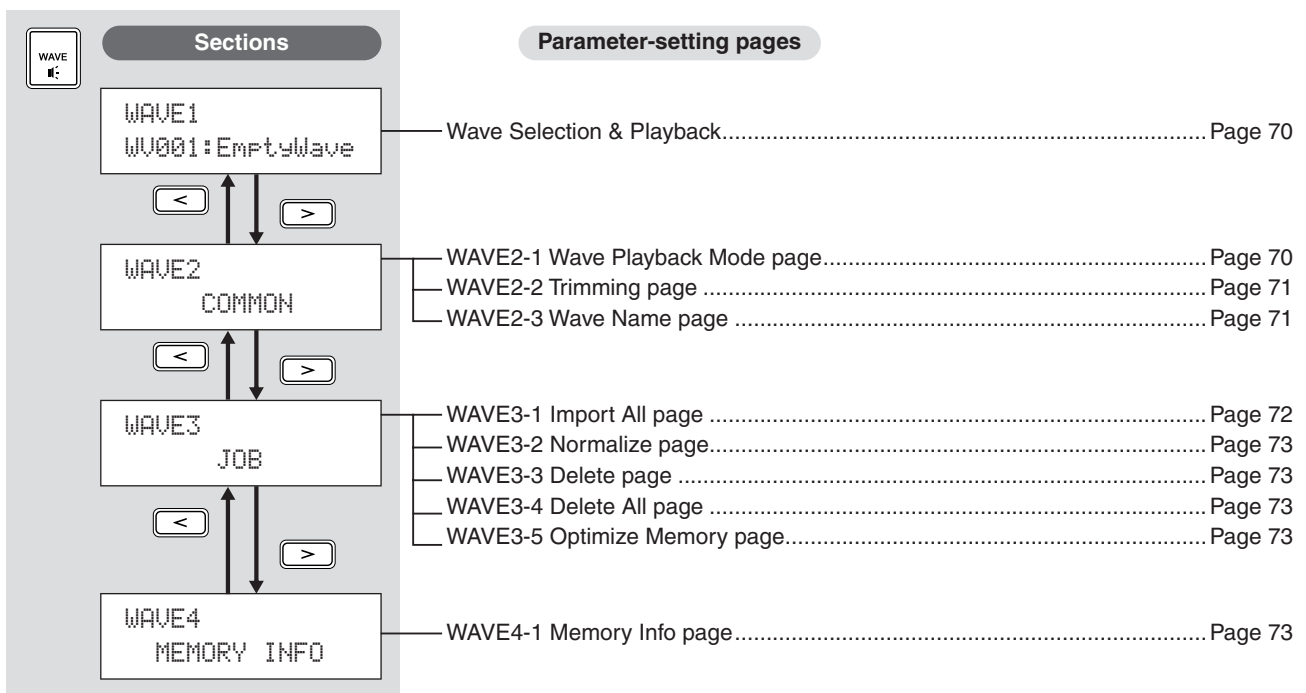

WAVE1

Wave Selection & Playback

You can use the Select Wave page (WAVE1) to select and play waves. Only waves that have been saved in the DTX-MULTI 12's internal memory by importing (see page 72) will be available for selection on this page. In other words, audio files stored on a USB memory device are not immediately made available for selection simply by plugging in the device.

On the Select Wave page, you can preview the currently selected wave by pressing and holding the [WAVE] button. Release the button to stop playback.

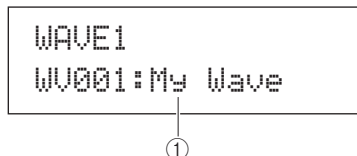

① **Wave number: Wave name**

Settings	WV001 to WV500
----------	----------------

WAVE2

Playback Mode, Trim Points & Name

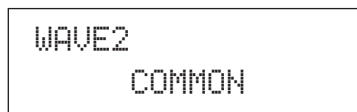

In the COMMON section, you can choose a playback mode for the currently selected wave and perform other related operations such as trimming and naming. With the COMMON page (WAVE2) displayed, press the [ENTER] button to access its three parameter-setting pages (WAVE2-1 to WAVE2-3). You can use the [<]/[>] buttons to navigate between these pages.

NOTE

- If the selected wave contains no data, the [ENTER] button will not open parameter-setting pages.

WAVE2-1 Wave Playback Mode page

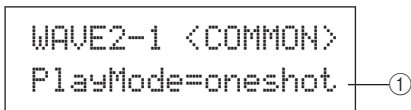

① **Playback mode (PlayMode)**

Use this parameter to set the way in which the selected wave will be played when assigned to a pad. For details on editing start, end, and loop points, see the description of the Trimming page (WAVE2-2) below.

- oneshot The wave will be played once only from the start point to the end point. This mode is normally selected for drums, special effects, and other non-looped sounds.
- loop The wave will be played continuously, first from the start point to the end point, and then repeatedly from the loop point to the end point.

Settings	oneshot or loop
----------	-----------------

One-shot playback

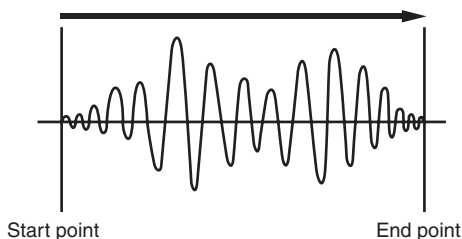

Looped playback

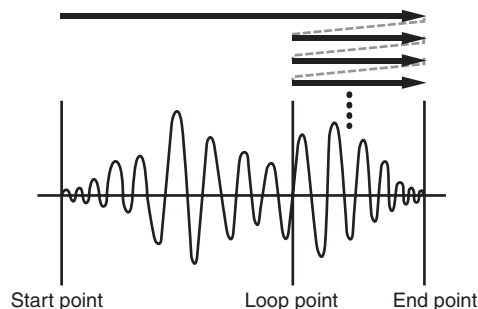

WAVE2-2 Trimming page

From the Trimming page, you can edit the currently selected wave's start, end, and loop points. With the Trimming page (WAVE2-2) displayed, press the [ENTER] button to open the Trimming Settings page.

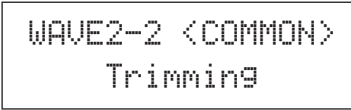

WAVE2-2-1 Trimming Settings page

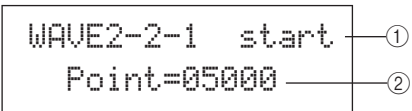

① Trim point

Use this parameter to select the trim point to be set. As shown in the diagram below, three different types of trim point can be selected – start, loop, and end.

- Start..... This is the position at which playback will start. In other words, no data in front of this point (i.e., with a smaller position value) will be played.
- Loop..... This is the position at which looping will start. If “loop” has been selected on the Wave Playback Mode page (WAVE2-1), playback will loop continuously between this point and the end point.
- End..... This is the position at which playback will end. In other words, no data behind this point (i.e., with a larger position value) will be played.

Settings	start, loop, or end
----------	---------------------

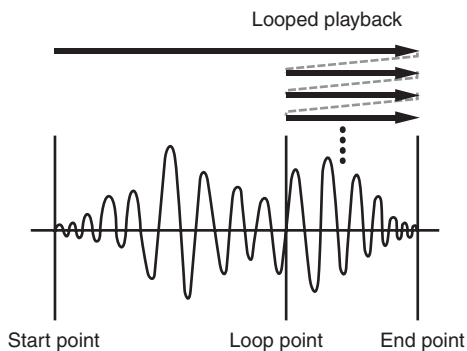

② Point

Use this parameter to specify a five-digit position value for the selected trim point. The [<]/[>] buttons can be used to move the cursor between digits, and the [-/DEC] and [+ /INC] buttons can be used to change the corresponding value.

Settings	From 00000
----------	------------

NOTE

- To audition your wave with the current settings, press the [WAVE] button with the Trimming Settings page displayed.

WAVE2-3 Wave Name page

From the Wave Name page, you can assign a name to the currently selected wave. With this page displayed, press the [ENTER] button to open the Wave Name Setting page.

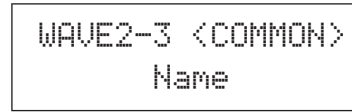

WAVE2-3-1 Wave Name Setting page

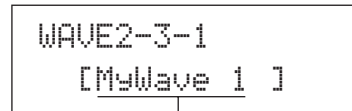

Wave name

On the Wave Name Setting page, you can set a wave name of up to 10 characters in length. Use the [<]/[>] buttons to move the flashing cursor to the character you want to change, and then select a new character using the [-/DEC] and [+ /INC] buttons. The following characters can be used in wave names.

```
[space]
! " # % & ' ( ) * + , - . / 0 1 2 3 4 5 6 7 8 9 : ; < = > ? @
A B C D E F G H I J K L M N O P Q R S T U V W X Y Z [ \ ] ^ _ `
a b c d e f g h i j k l m n o p q r s t u v w x y z { | } ~ +
```

WAVE3 JOB

Other Wave-Related Tasks

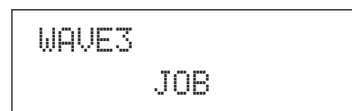

In the JOB section, you can create waves by importing WAV or AIFF files from a USB memory device into the DTX-MULTI 12's internal memory, and you can also perform a number of other related tasks. With the JOB page (WAVE3) displayed, press the [ENTER] button to access its five parameter-setting pages (WAVE3-1 to WAVE3-5). You can use the [<]/[>] buttons to navigate between these pages.

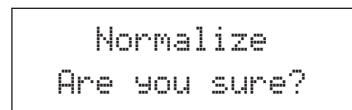

Whenever you press the [ENTER] button to perform an operation on a JOB section page, you will be asked to reconfirm that you want to do so. Press the [ENTER] button once again to proceed.

Reference

KIT

VOICE

MIDI

WAVE

PATTERN

UTILITY

TRIGGER

WAVE3-1 Import All page

Using the Import All page, you can import all WAV or AIFF files from a USB memory device into your DTX-MULTI 12's internal memory.

NOTE

- Files can also be imported individually, and the procedure for doing so is described on the right.
- Only WAV and AIFF audio files can be imported.

- 1 Ensure that the WAV or AIFF files to be imported are located in the USB memory device's root directory, using a computer to move them if necessary.
- 2 Plug the USB memory device into the instrument's USB TO DEVICE port.
- 3 With the JOB page (WAVE3) displayed, press the [ENTER] button, and if necessary, the [<]/[>] buttons to open the Import All page (WAVE3-1).

```
WAVE3-1  <JOB>
Import All
```

- 4 Press the [ENTER] button once again. You will be asked to confirm that you want to import all files. You can press the [EXIT] button to return to the previous page without importing.

```
Import All
Are you sure?
```

- 5 Press the [ENTER] button to import. Each imported wave will be automatically assigned a wave number.

```
Now Importing...
[EXIT] to cancel
```

You can press the [EXIT] button at any time during the import process to terminate it. Files that have been fully imported at that time will be retained in the DTX-MULTI 12's internal memory.

NOTE

- If there is insufficient free space in the instrument's internal memory, the message "Wave memory full." will be displayed and the import process will be terminated. Before repeating the import process, make additional memory available by deleting unneeded waves on the Delete page (WAVE3-3) or the Delete All page (WAVE3-4).

Importing Individual Audio Files

The following describes how to import individual WAV or AIFF files from a USB memory device into the DTX-MULTI 12's internal memory.

NOTE

- Only WAV and AIFF audio files can be imported.

- 1 Ensure that the WAV or AIFF file to be imported is located in the USB memory device's root directory, using a computer to move it if necessary.
- 2 Plug the USB memory device into the instrument's USB TO DEVICE port.
- 3 Hold down the [SHIFT] button and press the [WAVE] button to open the IMPORT page shown below.

```
IMPORT
Surdo.WAV
```

- 4 Use the [-/DEC] and [+ /INC] buttons to select the audio file you want to import.

```
IMPORT
FillX.AIF
```

Name of audio file to be imported

- 5 Press the [ENTER] button to import. When the selected file has been imported, the IMPORT page will allow you to assign it to a pad within the currently selected kit.

NOTE

- If there is insufficient free space in the instrument's internal memory, the message "Wave memory full." will be displayed and the import process will be terminated. Before repeating the import process, make additional memory available by deleting unneeded waves on the Delete page (WAVE3-3) or the Delete All page (WAVE3-4).

- 6 Use the [-/DEC] and [+ /INC] buttons to select the pad to which the wave is to be assigned.

The available options are 01 to 13, 13R1, 13R2, 14 to 17, FTSW, HHCL, and HHSP. You can also select a pad by striking it. Alternatively, you can select "off" to store the imported wave in the instrument's internal memory without assigning it to a pad at this time.

```
IMPORT
PadAssign=0000
```

Pad number

- 7 When you have assigned the wave as required, press the [ENTER] button to complete the procedure.

WAVE3-2 Normalize page

From the Normalize page, you can increase the volume of the currently selected wave. With this page displayed, press the [ENTER] button to open the Ratio page (WAVE3-2-1). Here you can specify how much the volume of the wave is to be increased.

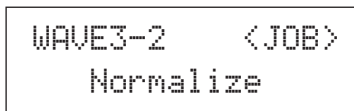

WAVE3-2-1 Ratio page

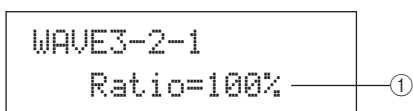

① **Ratio**

Use this parameter to specify how much the wave's volume is to be increased. Generally, a ratio of 100% or lower is used. With a setting of 100%, the volume will be increased to the maximum possible level without clipping. (Ratios greater than 100% can be specified; however, the wave may become distorted as a result.)

Settings	1 to 800
-----------------	----------

WAVE3-3 Delete page

From the Delete page, you can delete the wave currently selected on the Select Wave page (WAVE1).

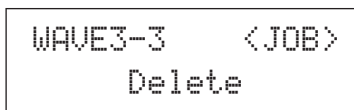

Press the [ENTER] button with the Delete page displayed, and when asked to confirm that you wish to proceed, press the [ENTER] button once again.

WAVE3-4 Delete All page

From the Delete All page, you can delete all waves from the DTX-MULTI 12's internal wave memory.

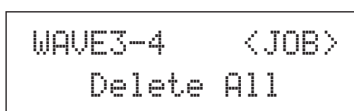

Press the [ENTER] button with the Delete All page displayed, and when asked to confirm that you wish to proceed, press the [ENTER] button once again.

WAVE3-5 Optimize Memory page

From the Optimize Memory page, you can maximize the amount of unused wave memory. In order to do this, the content of the DTX-MULTI 12's internal wave memory is rearranged to make more memory available. Optimization can be an effective way to increase the amount of memory available for waves.

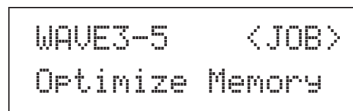

WAVE4 MEMORY INFO

Wave Memory Status

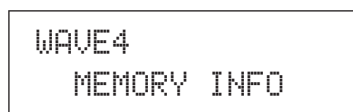

The MEMORY INFO section allows you to display the current usage status of the DTX-MULTI 12's wave memory. To view the memory-usage status, navigate to the MEMORY INFO section (WAVE4) and press the [ENTER] button.

WAVE4-1 Memory Info page

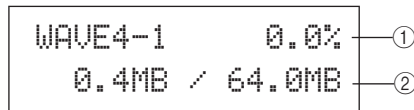

① **Memory usage ratio (%)**

This indicates how much of the total wave memory is currently being used in percentage format.

② **Used memory / Total memory**

This indicates separately the amount of wave memory used and the total wave memory in megabyte (MB) units.

NOTE

- Certain types of audio file may require more of the instrument's memory than indicated by the corresponding file size shown on your computer.

PATTERN Setting Area (PTN)

This section describes the PATTERN setting area, which can be accessed using the [PTN] button. Built into the DTX-MULTI 12 are a range of Preset patterns specially for playback (P001 to P128) in addition to User patterns that can be freely recorded and edited (U001 to U050). Use the PATTERN area to record and edit these patterns.

NOTE

- Parameter setting pages from the COMMON section (PTN2), the MIDI section (PTN3), and the JOB section (PTN4) will not be accessible when a Preset pattern has been selected. You can, however, edit a Preset pattern by first selecting an empty User pattern and then copying the Preset pattern into it using the Copy Pattern page (PTN4-5).

CAUTION

- Be sure to store any recorded patterns or settings that you have edited before turning off the instrument or selecting a new pattern. (See page 45.)

Makeup of PATTERN Setting Area

The PATTERN setting area is subdivided into five different sections (PTN1 to PTN5). Use the [<]/[>] buttons to navigate between these sections. If a section contains parameter-setting pages, the [ENTER] button will light up. Press the [ENTER] button to access these pages. In certain cases, a number of additional pages may be accessed from a parameter setting page, also using the lit [ENTER] button. Furthermore, you can press the [EXIT] button to move back towards the top of the setting area.

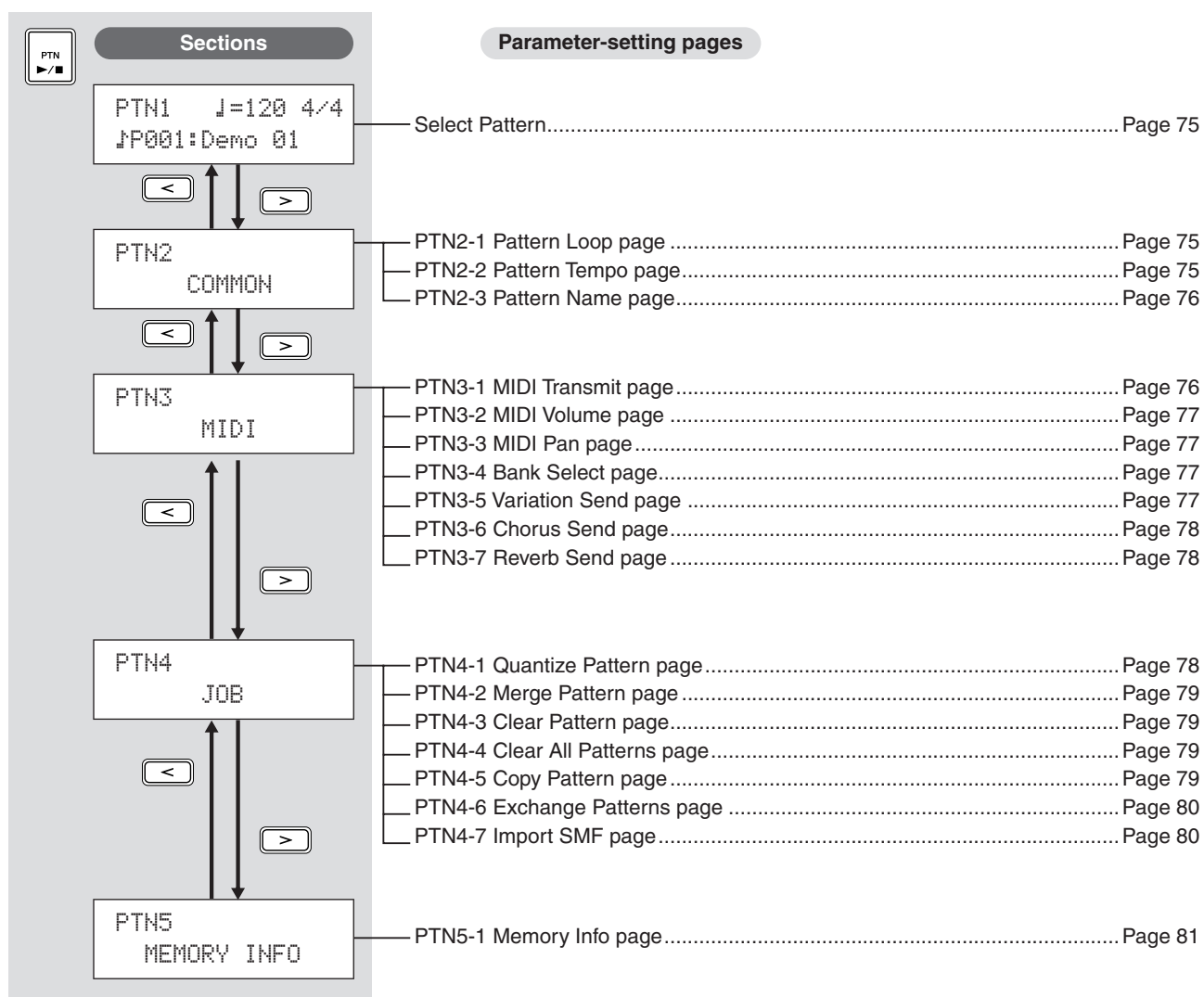

PTN1

Select Pattern

On the Select Pattern page (PTN1), you can select and play patterns and also set their tempo and time signature. To access this page, press the [PTN] button, and if necessary, the [<]/[>] buttons. If you again press the [PTN] button with this page displayed, the selected pattern will start to play. To stop playback, press the [PTN] button once again with the Select Pattern page (PTN1) displayed. Whenever you want to edit or record a pattern, furthermore, be sure to select it first on this page.

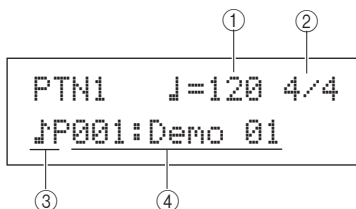

① **Tempo**

Use this parameter to set the tempo at which the selected pattern will be played.

Settings	30 to 300
-----------------	-----------

NOTE

- Whenever you select a new pattern, its tempo will be set automatically.
- The Tempo parameter's setting will be displayed as "ext" and modification will not be possible if "ext" has been selected on the UTILITY area's MIDI Sync page (UTIL6-6) or if "auto" has been selected on that page and MIDI clock messages are being received from an external device.

② **Time signature**

Use this parameter to set the time signature for playback of the selected pattern.

Settings	1/4 to 16/4, 1/8 to 16/8, or 1/16 to 16/16
-----------------	--

NOTE

- Whenever you select a new pattern, its time signature will be set automatically.

③ **Pattern category**

Use this parameter to select either the Preset (♪P) or User (♪U) pattern category.

Settings	♪P or ♪U
-----------------	----------

④ **Pattern number: Pattern name**

Use these parameters to select the pattern to be played, recorded, or processed.

Settings	With "♪P" (Preset pattern) selected: 001 to 128 With "♪U" (User pattern) selected: 001 to 050
-----------------	--

Whenever a demo pattern (P001 to P003) is being played, a page similar to that shown below will be displayed and modification of the tempo or time signature will not be possible.

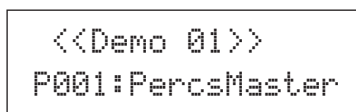

NOTE

- Playback of the click track or of patterns assigned to pads will be stopped whenever playback of a demo pattern is started.
- Playback of demo patterns can be stopped by pressing any button other than [SHIFT].

PTN2 COMMON

Looping, Tempo & Pattern Names

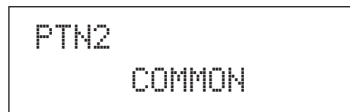

In the COMMON section, you can specify whether the currently selected pattern is to be played repeatedly as a loop, and you can also set its tempo and name. With the COMMON page (PTN2) displayed, press the [ENTER] button to access its three parameter-setting pages (PTN2-1 to PTN2-3). You can use the [<]/[>] buttons to navigate between these pages.

NOTE

- This section can be used only with User patterns. If a Preset pattern has been selected, the [ENTER] button will not open a parameter-setting page.

PTN2-1 Pattern Loop page

Using the Pattern Loop page, you can specify whether or not the selected pattern is to be played repeatedly as a loop. The selection made on this page will apply regardless of whether the pattern is played using the [▶/■] button or by striking a pad to which it has been assigned.

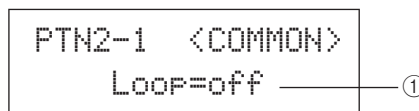

① **Loop**

If "on" is selected for this parameter, playback of the pattern will start again from the beginning whenever it finishes (i.e., looped playback). When set to "off", the pattern will be played once to the end and will then stop (i.e., one-shot playback).

Settings	off or on
-----------------	-----------

PTN2-2 Pattern Tempo page

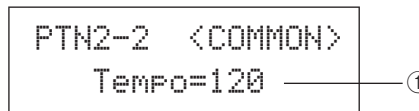

① **Tempo**

Use this parameter to set a tempo for playback of the selected pattern.

Settings	30 to 300
-----------------	-----------

NOTE

- If the pattern is assigned to a kit, the kit's tempo setting (see page 47) will take priority over this setting.

Reference
KIT
VOICE
MIDI
WAVE
PATTERN
UTILITY
TRIGGER

PTN2-3 Pattern Name page

With the Pattern Name page displayed, press the [ENTER] button to edit the name of the currently selected pattern.

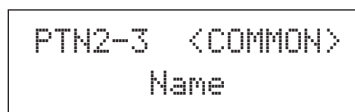

PTN2-3-1 Pattern Name Setting page

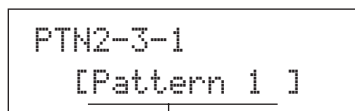

Pattern name

In the Pattern Name Setting page (PTN2-3-1), you can freely specify a pattern name of up to ten characters in length. Use the [<]/[>] buttons to move the flashing cursor to the character you want to change, and then select a character using the [-/DEC] and [+ /INC] buttons. The following characters can be used in pattern names.

[space]

```
!"#$%&'()*+,-./0123456789:;<=>?@
ABCDEFGHIJKLMN O PQRSTU VWXYZ[ \ ] ^ _ `
abcdefghijklmnopqrstuvwxyz{|}~
```

PTN3 MIDI

MIDI Settings for Patterns

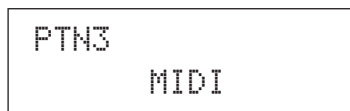

In the MIDI section, you can configure the MIDI messages sent by the currently selected pattern on each individual MIDI channel. These settings affect MIDI messages sent to both the DTX-MULTI 12's internal tone generator and external MIDI devices. With the MIDI page (PTN3) displayed, press the [ENTER] button to access its seven parameter-setting pages (PTN3-1 to PTN3-7). You can use the [<]/[>] buttons to navigate between these pages.

NOTE

- This section can be used only with User patterns. If a Preset pattern has been selected, the [ENTER] button will not open a parameter-setting page.

PTN3-1 MIDI Transmit page

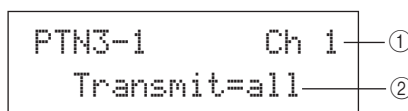

① **MIDI channel (Ch)**

Use this parameter to select the MIDI channel (1 to 16) to be set.

Settings	1 to 16
----------	---------

② **Transmit**

Use this parameter to specify which MIDI messages will be sent to the internal tone generator and to external MIDI devices by the currently selected pattern on the MIDI channel indicated by ①.

- off..... No MIDI messages will be sent.
- all..... All applicable MIDI messages will be sent.
- PC..... Only MIDI Program Change messages (including bank-select MSB/LSB) will be sent.

Settings	off, all, or PC
----------	-----------------

PTN3-2 MIDI Volume page

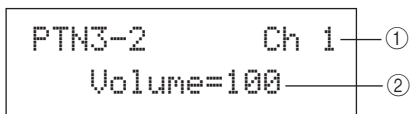

① **MIDI channel (Ch)**

Settings	1 to 16
----------	---------

② **Volume**

Use this parameter to set the MIDI volume (Control Change 7) sent by the currently selected pattern on the MIDI channel indicated by ①. In terms of the internal tone generator, this value affects all voices played on that channel.

Settings	0 to 127
----------	----------

NOTE

- If "off" or "PC" has been selected on the MIDI Transmit page (PTN3-1), this setting will be displayed as "---" and modification will not be possible.
- If you change the volume setting for MIDI channel 10, the setting on the Kit Volume page (KIT2-1) will also change to this new setting.

PTN3-3 MIDI Pan page

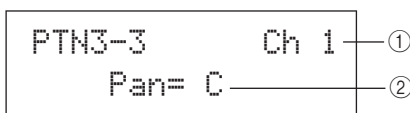

① **MIDI channel (Ch)**

Settings	1 to 16
----------	---------

② **Pan**

Use this parameter to set the stereo panning (Control Change 10) sent by the currently selected pattern on the MIDI channel indicated by ①. In terms of the internal tone generator, this value affects all voices played on that channel.

Settings	L64 to C to R63
----------	-----------------

NOTE

- If "off" or "PC" has been selected on the MIDI Transmit page (PTN3-1), this setting will be displayed as "---" and modification will not be possible.

PTN3-4 Bank Select page

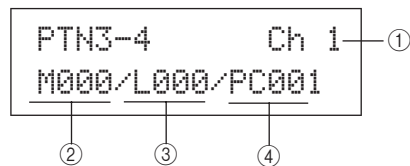

① **MIDI channel (Ch)**

Settings	1 to 16
----------	---------

② **Bank select MSB (M)**

Use this parameter to set a bank-select MSB value.

Settings	000 to 127
----------	------------

③ **Bank select LSB (L)**

Use this parameter to set a bank-select LSB value.

Settings	000 to 127
----------	------------

④ **Program change (PC)**

Use this parameter to set a program-change number sent by the currently selected pattern on the MIDI channel indicated by ①.

Settings	001 to 128
----------	------------

NOTE

- If "off" has been selected on the MIDI Transmit page (PTN3-1), this setting will be displayed as "---" and modification will not be possible.

To select a DTX-MULTI 12 drum kit, set parameters for MIDI channel 10 as follows.

- Preset kits:
MSB = 125, LSB = 000, PC = Preset kit number
- User kits between U001 and U100:
MSB = 125, LSB = 001, PC = 001 to 100
- User kits between U101 and U200:
MSB = 125, LSB = 002, PC = 001 to 100

If a program-change setting is made for MIDI channel 10, the current drum kit will be changed immediately.

PTN3-5 Variation Send page

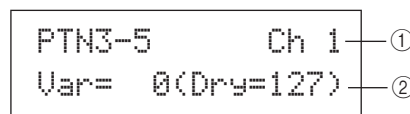

① **MIDI channel (Ch)**

Settings	1 to 16
----------	---------

② **Variation send level (Var)**

Use this parameter to set the variation-send level to be sent by the currently selected pattern.

Settings	0 to 127
----------	----------

NOTE

- If "off" or "PC" has been selected on the MIDI Transmit page (PTN3-1), this setting will be displayed as "---" and modification will not be possible.
- If MIDI channel 10 is selected, this setting will be displayed as "---" and modification will not be possible.

Reference
KIT
VOICE
MIDI
WAVE
PATTERN
UTILITY
TRIGGER

PTN3-6 Chorus Send page

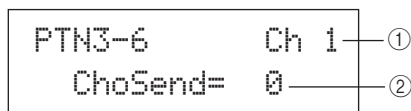

① MIDI channel (Ch)

Settings	1 to 16
----------	---------

② Chorus send level (ChoSend)

Use this parameter to set the chorus-send level to be sent by the currently selected pattern.

Settings	0 to 127
----------	----------

NOTE

- If "off" or "PC" has been selected on the MIDI Transmit page (PTN3-1), this setting will be displayed as "---" and modification will not be possible.
- If you change the chorus send level for MIDI channel 10, the setting on the Chorus Send page (KIT3-1) for the currently selected kit will also change to this new setting.

PTN3-7 Reverb Send page

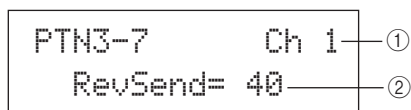

① MIDI channel (Ch)

Settings	1 to 16
----------	---------

② Reverb send level (RevSend)

Use this parameter to set the reverb-send level to be sent by the currently selected pattern.

Settings	0 to 127
----------	----------

NOTE

- If "off" or "PC" has been selected on the MIDI Transmit page (PTN3-1), this setting will be displayed as "---" and modification will not be possible.
- If you change the reverb send level for MIDI channel 10, the setting on the Reverb Send page (KIT3-2) for the currently selected kit will also change to this new setting.

PTN4 JOB

Pattern Quantization & Management

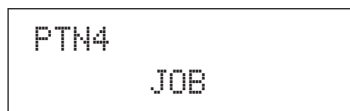

In the JOB section, you can quantize the currently selected User pattern, import SMF files, and perform other related tasks. With the JOB page (PTN4) displayed, press the [ENTER] button to access its seven parameter-setting pages (PTN4-1 to PTN4-7). You can use the [<]/[>] buttons to navigate between these pages.

NOTE

- This section can be used only with User patterns. If a Preset pattern has been selected, the [ENTER] button will not open a parameter-setting page.

PTN4-1 Quantize Pattern page

From the Quantize Pattern page, you can correct irregularities in the timing of notes making up the currently selected User pattern. This is referred to as quantizing. With the Quantize page displayed, press the [ENTER] button to open the Quantize Pattern Setting page.

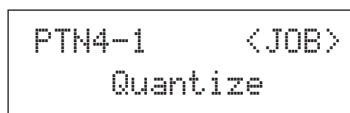

PTN4-1-1 Quantize Pattern Setting page

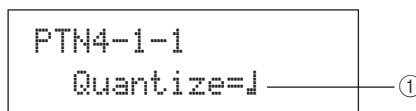

① Quantize

Use this parameter to specify the quantizing resolution as a division of a whole note. The lower the resolution, the finer the correction of timing.

Settings	When time signature from PTN1 or for recording is 3/8, 6/8, 9/8, 12/8, or 15/8:
	♪♪♪ 16 th note triplets
	♪ 16 th notes
	♪♪ 8 th note triplets
	♪ 8 th notes
	♪ 4 th notes
	♪. Dotted 4 th notes
	When time signature from PTN1 is other than the above:
	♪♪♪ 16 th note triplets
	♪ 16 th notes
	♪♪ 8 th note triplets
	♪ 8 th notes
	♪♪ 4 th note triplets
	♪ 4 th notes

CAUTION

- The natural groove of a recorded performance may be lost as a result of quantization. Note that once a pattern is quantized, it will not be possible to reverse the procedure.

Example of how quantizing works

These recorded notes were not played exactly in time.

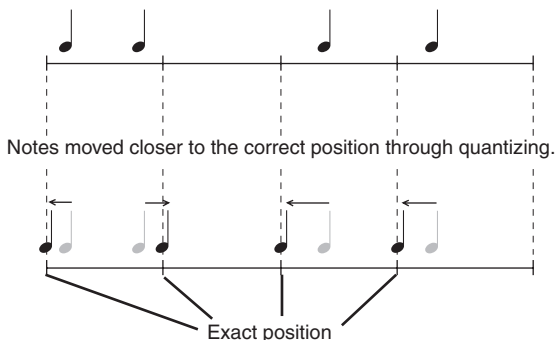

PTN4-2 Merge Pattern page

From the Merge Pattern page, you can merge two patterns and store the result as a User pattern. To start, select a User pattern to hold the merged pattern on the Select Pattern page (PTN1). Then, navigate to the Merge Pattern page and press the [ENTER] button to open the Merge Pattern Settings page.

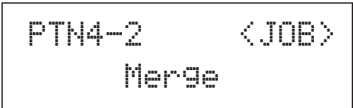

PTN4-2-1 Merge Pattern Settings page

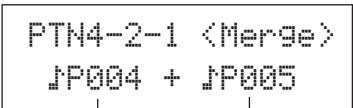

- ① Merge pattern 1
- ② Merge pattern 2

Use the above two parameters to specify the patterns that are to be merged as one.

Settings	♪P004 to ♪P128 or ♪U001 to ♪U050
----------	----------------------------------

NOTE

- If the User pattern selected before opening the Merge Pattern page already contains data, it will be overwritten with the merged pattern.
- The tempo and time signature of Merge pattern 1 are set as the tempo and time signature of the merged pattern. If Merge pattern 1 is empty, however, the tempo and time signature of Merge pattern 2 are used.
- The channel-specific MIDI settings of Merge pattern 1 are set as those of the merged pattern. In the case, however, of MIDI channels for which Merge pattern 1 contains no settings, any applicable settings from Merge pattern 2 will be applied.
- Generally speaking, only patterns with similar tempos, time signatures, and MIDI voice settings should be merged.
- Demo patterns cannot be selected for merging.

PTN4-3 Clear Pattern page

From the Clear Pattern page, you can delete all data from the currently selected User pattern. To do so, press the [ENTER] button with the Clear Pattern page displayed, and when asked to confirm that you wish to proceed, press the [ENTER] button once again.

CAUTION

- When a User pattern is cleared as described above, its data is completely erased from the instrument's pattern memory. Be sure, therefore, to always save important data on a USB memory device or the like before deleting.

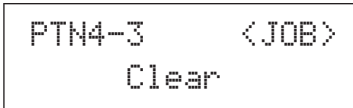

PTN4-4 Clear All Patterns page

From the Clear All Patterns page, you can delete data from all User patterns. To do so, press the [ENTER] button with the Clear All Patterns page displayed, and when asked to confirm that you wish to proceed, press the [ENTER] button once again.

CAUTION

- When User patterns are cleared as described above, their data is completely erased from the instrument's pattern memory. Be sure, therefore, to always save important data on a USB memory device or the like before deleting.

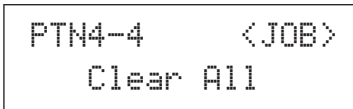

PTN4-5 Copy Pattern page

From the Copy Pattern page, you can copy a pattern to the currently selected User pattern. With the Copy Pattern page displayed, press the [ENTER] button to open the Copy Pattern Setting page.

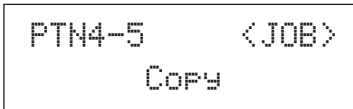

Reference
KIT
VOICE
MIDI
WAVE
PATTERN
UTILITY
TRIGGER

PTN4-5-1 Copy Pattern Setting page

With the Copy Pattern Setting page displayed, press the [ENTER] button, and when asked to confirm that you wish to proceed, press the [ENTER] button once again.

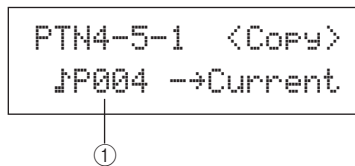

① **Pattern to be copied**

Use this parameter to select the pattern to be copied to the currently selected User pattern.

Settings	♪P004 to ♪P128 or ♪U001 to ♪U050
-----------------	----------------------------------

CAUTION

- The currently selected User pattern is overwritten as a result of this procedure. Be sure, therefore, to always save important data on a USB memory device or the like before copying patterns.

NOTE

- Demo patterns cannot be copied.

PTN4-6 Exchange Patterns page

From the Exchange Patterns page, you can swap a pair of User patterns. With the Exchange Patterns page displayed, press the [ENTER] button to open the Exchange Patterns Settings page.

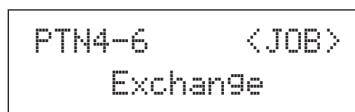

PTN4-6-1 Exchange Patterns Settings page

With the Exchange Patterns Settings page displayed, press the [ENTER] button, and when asked to confirm that you wish to proceed, press the [ENTER] button once again.

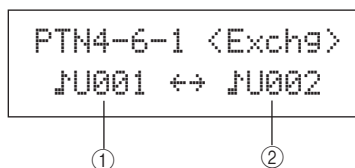

- ① **Exchange pattern 1**
- ② **Exchange pattern 2**

Use these parameters to select the two User patterns to be swapped.

Settings	♪U001 to ♪U050
-----------------	----------------

PTN4-7 Import SMF page

From the Import SMF page, you can import a standard MIDI file (SMF) into the DTX-MULTI 12 from a USB memory device for use as a User pattern. SMFs contain sequenced MIDI data and have a “.mid” file extension. It should be noted that the DTX-MULTI 12 supports Format 0 SMFs only.

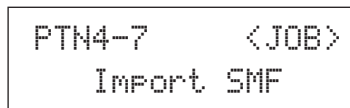

PTN4-7-1 Import SMF Setting page

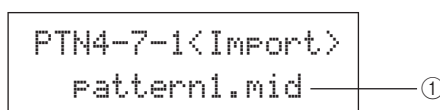

① **SMF file name**

Use this parameter to select the SMF to be imported.

Settings	Any SMF file having extension .mid and stored in the USB memory device's root directory.
-----------------	--

- 1 **Plug a USB memory device containing the Format-0 SMF to be imported into the USB TO DEVICE port on the side panel of the DTX-MULTI 12.**
- 2 **Navigate to the Import SMF page (PTN4-7) and press the [ENTER] button to open the Import SMF Setting page (PTN4-7-1) shown above. Select the SMF to be imported and then press the [ENTER] button once again.**

You will be asked to confirm that you wish to proceed.

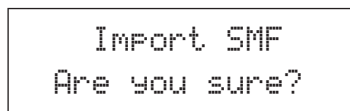

- 3 **To import the selected SMF, press the [ENTER] button. Alternatively, press the [EXIT] button to return to the previous page without importing.**

NOTE

- If the currently selected User pattern already contains pattern data, it will be overwritten with the imported data.

The message “Now importing...” will be displayed during the import process.

CAUTION

- Do not unplug the USB memory device from the USB TO DEVICE port or turn off either the USB memory device or the DTX-MULTI 12 while data is being imported. Failure to observe this precaution can lead to the USB memory device or the DTX-MULTI 12 being permanently damaged.

NOTE

- Only standard MIDI files of Format 0 can be imported.
- In certain cases where a User pattern created from an imported SMF is looped, voices may not change as expected when playback jumps from the end back to the beginning, and instead, the voices settings from the end of the pattern will be maintained throughout. Specifically, this happens when program change data from the SMF's header is not read upon return to the start of the pattern. To prevent this type of unintended situation, move any program change messages slightly back from the SMF header to ensure that they will be correctly read.

PTN5 MEMORY INFO**Pattern Memory Status**

```
PTN5
MEMORY INFO
```

The MEMORY INFO section allows you to check the usage status of DTX-MULTI 12 memory for User patterns. To do so, navigate to this section (PTN5) and press the [ENTER] button.

PTN5-1 Memory Info page

```
PTN5-1      0.0% ①
0.4KB/896.0KB ②
```

① **Memory usage ratio (%)**

This indicates how much of the total User-pattern memory is currently being used in percentage format.

② **Used memory / Total memory (KB)**

This indicates separately the amount of memory used and the total memory in kilobyte (KB) units.

UTILITY Setting Area (UTIL)

This section describes the UTILITY setting area, which can be accessed using the [UTILITY] button. In this area, you can set parameters affecting the entire instrument and perform a range of file management operations.

CAUTION

- Be sure to store any settings that you have edited before turning off the instrument. (See page 45.)

Makeup of UTILITY Setting Area

The UTILITY setting area is subdivided into three different sections (UTIL1 to UTIL3). Use the [<]/[>] buttons to navigate between these sections. If a section contains parameter-setting pages, the [ENTER] button will light up. Press the [ENTER] button to access these pages. In certain cases, a number of additional pages may be accessed from a parameter setting page, also using the lit [ENTER] button. Furthermore, you can press the [EXIT] button to move back towards the top of the setting area.

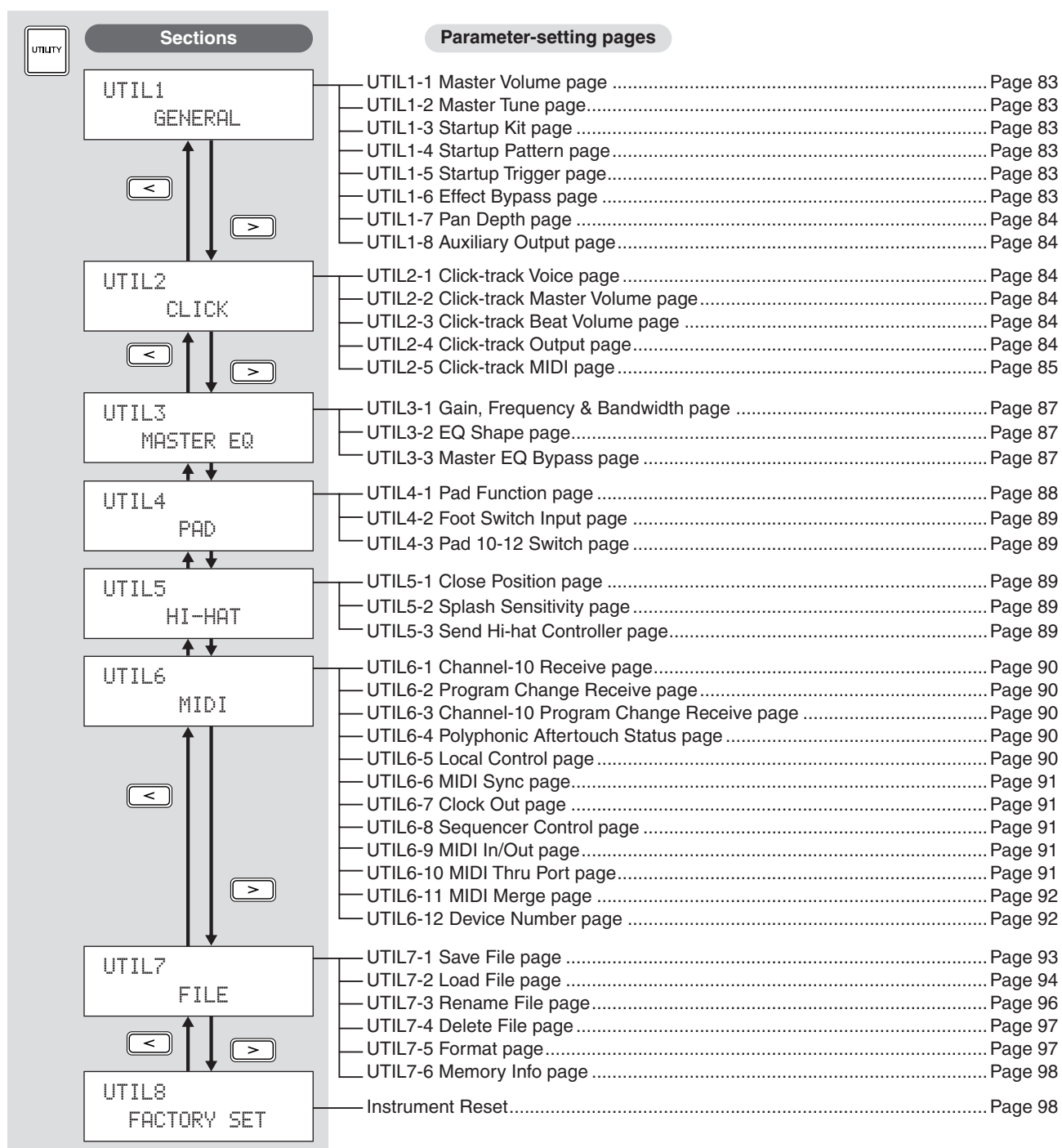

UTIL1 GENERAL

System Settings

```
UTIL1
GENERAL
```

In the GENERAL section, you can set parameters affecting the entire system. With the GENERAL page (UTIL1) displayed, press the [ENTER] button to access its eight parameter-setting pages (UTIL1-1 to UTIL1-8). You can use the [<]/[>] buttons to navigate between these pages.

UTIL1-1 Master Volume page

```
UTIL1-1<GENERAL>
MasterVolume=127
```

① Master volume

Use this parameter to set the master volume of the instrument's internal tone generator. If a small value is set here, the VOLUME dial on the front panel will have very little effect in increasing the output volume.

Settings	0 to 127
----------	----------

UTIL1-2 Master Tune page

```
UTIL1-2 M.Tune=
+ 0.0(440.0Hz)
```

① Master tune (M.Tune)

Use this parameter to tune (i.e., adjust the basic pitch of) the internal tone generator. The value in parentheses shows the corresponding tuning (of A above middle C) in Hertz.

Settings	-102.4 to +0.0 to +102.3
----------	--------------------------

NOTE

- The term "cent" refers to one hundredth of a semitone (i.e., 100 cents = 1 semitone).

UTIL1-3 Startup Kit page

```
UTIL1-3<GENERAL>
StartupKit=P001
```

① StartupKit

Use this parameter to specify the kit to be automatically selected when the DTX-MULTI 12 is turned on. Kits are identified using a category (P for Preset, U for User) and a number, and you can move the cursor using the [<]/[>] buttons to set these individually.

Settings	P001 to P050 or U001 to U200
----------	------------------------------

UTIL1-4 Startup Pattern page

```
UTIL1-4<GENERAL>
StartupPtn=J P001
```

① Startup pattern (StartupPtn)

Use this parameter to select the pattern that will be automatically set when the DTX-MULTI 12 is turned on. Patterns are identified using a category (J P for Preset, J U for User) and a number, and you can move the cursor using the [<]/[>] buttons to set these individually.

Settings	J P001 to J P128 or J U001 to J U050
----------	--------------------------------------

UTIL1-5 Startup Trigger page

```
UTIL1-5<GENERAL>
StartupTrg=P01
```

① Startup trigger (StartupTrg)

Use this parameter to select the trigger setup that will be automatically selected when the DTX-MULTI 12 is turned on. Trigger setups are identified using a category (P for Preset, U for User) and a number, and you can move the cursor using the [<]/[>] buttons to set these individually.

Settings	P01 to P05 or U01 to U10
----------	--------------------------

UTIL1-6 Effect Bypass page

```
UTIL1-6 FXByPs=
var/cho/rev
```

① Variation effect (var)

② Chorus effect (cho)

③ Reverb effect (rev)

Use these parameters to specify which effects will be bypassed when Effect Bypass is activated from the front panel (using the [SHIFT] and [KIT] buttons). When "---" is selected for an effect type, it will not be bypassed.

Settings	---/var, ---/cho, or ---/rev
----------	------------------------------

UTIL1-7 Pan Depth page

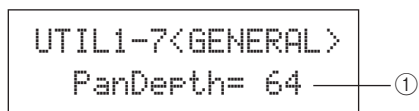

① **Pan depth**

Use this parameter to adjust the width of the instrument's overall stereo-panning field while maintaining the individual pan settings for drum and musical instrument sounds.

Settings	1 to 127
-----------------	----------

UTIL1-8 Auxiliary Output page

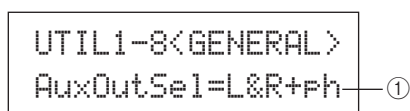

① **Auxiliary output selection (AuxOutSel)**

Use this parameter to indicate where audio input via the AUX IN jack will be output.

- L&R+ph Auxiliary-input audio will be output via both the OUTPUT (L/MONO and R) and PHONES jacks.
- phones Auxiliary-input audio will be output via the PHONES jack only.

Settings	L&R+ph or phones
-----------------	------------------

UTIL2 CLICK

Click Track Settings

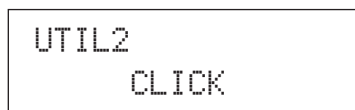

In the CLICK section, you can set parameters related to the click track. For example, you can set the type of sound to be used, the volume, and where the click track will be output. MIDI parameters related to the click track can also be set here. With the CLICK page (UTIL2) displayed, press the [ENTER] button to access its five parameter-setting pages (UTIL2-1 to UTIL2-5). You can use the [**<**]/[**>**] buttons to navigate between these pages.

UTIL2-1 Click-track Voice page

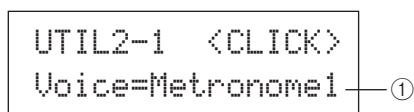

① **Click-track voice**

Use this parameter to select from a range of different sounds for use with the click track.

Settings	Metronome1, Metronome2, Cowbell, Stick, Human
-----------------	---

UTIL2-2 Click-track Master Volume page

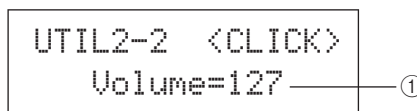

① **Click-track master volume**

Use this parameter to set the master volume for click-track sounds.

Settings	0 to 127
-----------------	----------

UTIL2-3 Click-track Beat Volume page

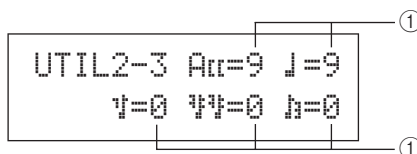

① **Click-track beat volumes**

Use these parameters to set volumes for different beat timings within the click track. The meanings of the symbols used on this page are shown below.

Example: Beat timings for four beats per bar

Accents **Acc**

4th notes **J**

8th notes **V**

16th notes **W**

8th note triplets **H**

Settings	0 to 9
-----------------	--------

NOTE

- If the time signature from the PATTERN setting area or for pattern recording is 3/8, 6/8, 9/8, 12/8, or 15/8, this page will display ACC, dotted quarter notes, eighth notes, and sixteenth notes.

UTIL2-4 Click-track Output page

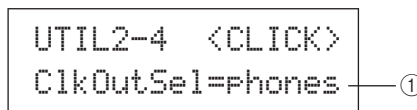

① **Click-track output selection (CikOutSel)**

Use this parameter to specify where the click track will be output when activated. In a live-performance setting, for example, you would normally want the click track to be output to headphones only, and in such a case, "phones" should be selected here.

- L&R+ph The click-track will be output via both the OUTPUT (L/MONO and R) and PHONES jacks.
- phones The click-track will be output via the PHONES jack only.

Settings	L&R+ph, phones
-----------------	----------------

UTIL2-5 Click-track MIDI page

```
UTIL2-5
Click MIDI
```

From the Click-track MIDI page (UTIL2-5), you can set a range of MIDI parameters related to the click track. With this page displayed, press the [ENTER] button to access a further four parameter-setting pages (UTIL2-5-1 to UTIL2-5-4). You can use the [<]/[>] buttons to navigate between these pages.

UTIL2-5-1 Click-track MIDI In page

```
UTIL2-5-1<CLICK>
MIDI IN=off
```

① MIDI IN

Use this parameter to specify whether or not click-track sounds are to be produced based on MIDI Note On messages received via the MIDI IN connector. When set to “on”, the DTX-MULTI 12 operates as follows:

- A click-track accent sound will be produced upon the receipt of a MIDI note with the note number set on the Accent Note Number page (UTIL2-5-3).
- A click-track quarter note sound will be produced upon the receipt of a MIDI note with the note number set on the Quarter-Note Note Number page (UTIL2-5-4).

Settings	off or on
-----------------	-----------

UTIL2-5-2 Click-Track MIDI Out page

```
UTIL2-5-2<CLICK>
MIDI OUT=off
```

① MIDI OUT

Use this parameter to turn the output of click-track MIDI events (i.e., MIDI Note On messages) on and off. When set to “on”, the DTX-MULTI 12 operates as follows:

- A MIDI note with the note number set on the Accent Note Number page (UTIL2-5-3) will be produced for each click-track accent sound.
- A MIDI note with the note number set on the Quarter-Note Note Number page (UTIL2-5-4) will be produced for each click-track quarter note sound.

Settings	off or on
-----------------	-----------

NOTE

- Regardless of this parameter's setting, no MIDI Note On messages can be produced for click-track sounds other than accents and quarter notes.

UTIL2-5-3 Accent Note Number page

```
UTIL2-5-3<CLICK>
NoteAcc=C#-1/ 13
```

① Accent note number (NoteAcc)

Use this parameter to assign a MIDI note number to click-track accent sounds.

Settings	off or C#-2 to F#8
-----------------	--------------------

- If “on” is selected on the Click-track MIDI In page (UTIL2-5-1), a click-track accent sound will be produced each time a MIDI note with the note number set here is received.

NOTE

- If “off” is selected on this page (UTIL2-5-3), no click-track accent sounds will be produced in response to received MIDI notes.
- If the same value is set on this page (UTIL2-5-3) and on the Quarter-Note Note Number page (UTIL2-5-4), the same sound will be produced for all beat timings.
- If “on” is selected on the Click-Track MIDI Out page (UTIL2-5-2), a MIDI Note On message with the note number set here will be produced for each click-track accent sound.

NOTE

- If “off” is selected both on this page (UTIL2-5-3) and on the Quarter-Note Note Number page (UTIL2-5-4), no MIDI Note On messages will be output for click-track sounds. If, however, “off” is selected on this page (UTIL2-5-3) but a setting other than “off” is selected on the Quarter-Note Note Number page (UTIL2-5-4), MIDI Note On messages with the corresponding note number will be output for all click-track sounds.

UTIL2-5-4 Quarter-Note Note Number page

```
UTIL2-5-4<CLICK>
NoteJ=C#-1/ 13
```

① Quarter-note note number (NoteJ)

Use this parameter to assign a MIDI note number to click-track quarter note sounds.

Settings	off or C#-2 to F#8
-----------------	--------------------

- If “on” is selected on the Click-track MIDI In page (UTIL2-5-1), a click-track quarter-note sound will be produced each time a MIDI note with the note number set here is received.

NOTE

- If “off” is selected on this page (UTIL2-5-4), no click-track quarter-note sounds will be produced in response to received MIDI notes.
- If “on” is selected on the Click-Track MIDI Out page (UTIL2-5-2), a MIDI Note On message with the note number set here will be produced for each click-track quarter-note sound.

NOTE

- If “off” is selected on this page (UTIL2-5-4), no MIDI Note On messages will be produced for click-track quarter-note sounds.

Tap Tempo

Using the Tap Tempo function, you can set the tempo for patterns and the click track by simply striking pads. In this way, you can conveniently and intuitively set the tempo that you need.

1 Hold down the [SHIFT] button and press the [A] (click) button.

The Tap Tempo page will open displaying the current tempo setting.

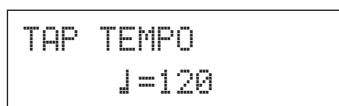

2 Strike one or more of the pads several times at the required tempo.

The DTX-MULTI 12 will automatically determine the tempo based on the speed at which you strike the pads, and this tempo will be displayed on-screen.

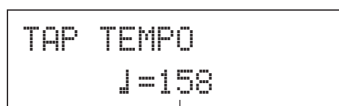

Tempo: 30 to 300

3 To check the tempo, press the [A] (click) button to start the click track.

The click track will be played at the tempo set using the Tap Tempo function. Whenever you change the tempo using this function, the new setting will be immediately applied to the click track and any patterns being played.

NOTE

- The [-/DEC] and [+/INC] buttons can also be used to adjust the tempo on the Tap Tempo page.
- If Func has been set to “tap tempo” for any of the pads on the UTILITY area’s Pad Function page (UTIL4-1), that pad can be used at any time to tap the tempo without having to open the Tap Tempo page (see page 88).
- If “ext” has been selected on the UTILITY area’s MIDI Sync page (UTIL 6-6) or if “auto” has been selected on that page and MIDI Clock messages are being received from an external source, the tempo value will be displayed as “ext” and playback on your DTX-MULTI 12 will be synchronized with the connected MIDI devices or DAW application.
- If “int” has been selected on the UTILITY area’s MIDI Sync page (UTIL 6-6) or if “auto” has been selected on that page and MIDI Clock messages are not being received from an external source, playback will occur at the DTX-MULTI 12’s current tempo setting (see page 91).

UTIL3 MASTER EQ

Master Equalization

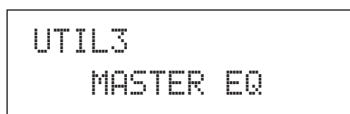

In the MASTER EQ section, you can adjust the master equalization parameters that control the tone of all preset voices, patterns, and waves. With the MASTER EQ page (UTIL3) displayed, press the [ENTER] button to access its three parameter-setting pages (UTIL3-1 to UTIL3-3). You can use the [<]/[>] buttons to navigate between these pages.

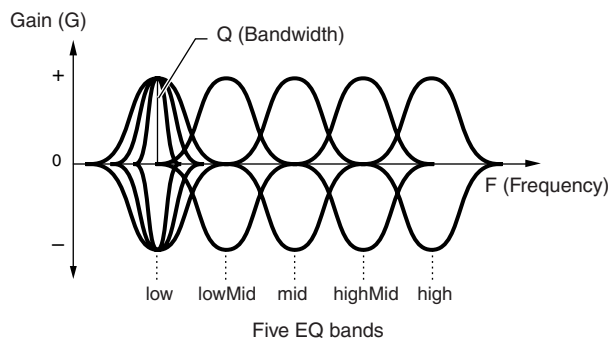

The DTX-MULTI 12 features a five-band master equalizer that allows the signal level to be freely boosted or cut around a center frequency specified for each of the bands. In addition, the “low” and “high” frequency bands can be set to either shelving or peaking equalization.

NOTE

- Master equalization has no effect on signals from the AUX IN connector. (See page 36)
- Master equalization has no effect on signals output via the PHONES jack. (See page 36)

UTIL3-1 Gain, Frequency & Bandwidth page

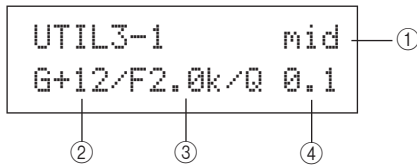

① **Frequency band**

Use this parameter to select the master-EQ frequency band to be set.

Settings	low, lowMid, mid, highMid, or high
-----------------	------------------------------------

② **Gain (G)**

Use this parameter to specify the amount by which the signal level in the frequency band indicated by ① will be boosted or cut.

Settings	-12 to +0 to +12
-----------------	------------------

③ **Frequency (F)**

Use this parameter to specify the frequency within the band indicated by ① around which the signal level will be cut or boosted. If the "low" band has been selected, the range of available frequencies will depend on the EQ type set using the Shape parameter on the EQ Shape page (UTIL3-2).

Settings	low: 32 to 2.0k for "shelving" 63 to 2.0k for "peaking" lowMid, mid, and highMid: 100 to 10k high: 500 to 16k
-----------------	--

④ **Bandwidth (Q)**

Use this parameter to specify a width for the band of frequencies to be boosted or cut. If you set a large value, a narrower band of frequencies will be affected and the tone will change markedly around the center frequency. If you set a smaller value, a wider band of frequencies will be affected and the tone will change gradually around the center frequency.

Settings	0.1 to 12.0
-----------------	-------------

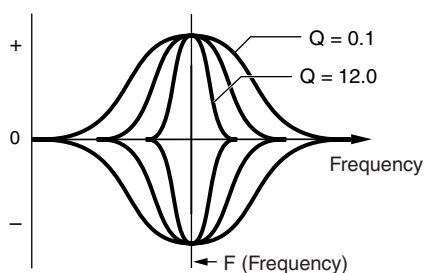

NOTE

- When "low" or "high" is indicated by ① and "shelving" has been set using the Shape parameter on the EQ Shape page (UTIL3-2), the setting for Bandwidth (Q) will be displayed as "----" and modification will not be possible.

UTIL3-2 EQ Shape page

On the EQ Shape page, you can set an EQ type for each of the "low" and "high" bands.

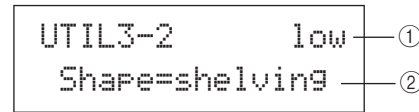

① **Frequency band**

Use this parameter to select the master-EQ frequency band to be set.

Settings	low or high
-----------------	-------------

② **Shape**

Use this parameter to set an EQ type.

Settings	shelving or peaking
-----------------	---------------------

● **shelving:**

Signals at all frequencies either above or below the specified frequency will be boosted or cut.

EQ low

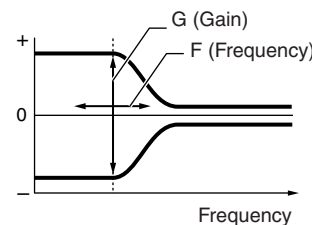

EQ high

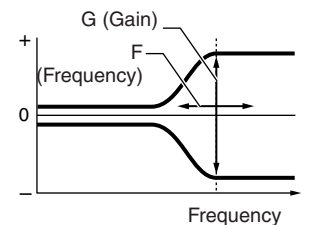

● **peaking:**

Signals within a band of frequencies around the specified frequency will be boosted or cut.

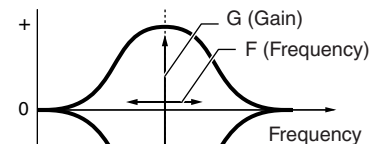

UTIL3-3 Master EQ Bypass page

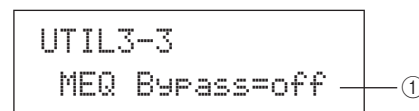

① **Master EQ bypass (MEQBypass)**

Use this parameter to specify whether the master EQ will be bypassed ("on") or applied ("off").

Settings	off or on
-----------------	-----------

Reference
KIT
VOICE
MIDI
WAVE
PATTERN
UTILITY
TRIGGER

UTIL4 PAD

Pad Utilities

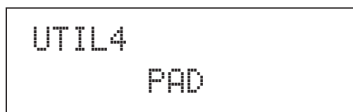

In the PAD section, you can assign functions to pads and external controllers, specify the type of controller connected via the FOOT SW jack, and enable or disable rim pads 10 to 12. With the PAD page (UTIL4) displayed, press the [ENTER] button to access its three parameter-setting pages (UTIL4-1 to UTIL4-3). You can use the [**<**]/[**>**] buttons to navigate between these pages.

UTIL4-1 Pad Function page

On the Pad Function page, you can specify operations to be performed when individual pads or external controllers are struck or operated.

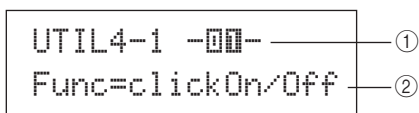

① **Pad number**

Use this parameter to select the pad or external controller to be set. You can also strike a pad to select it.

Settings	01 to 12, 13, 13R1, 13R2, 14 to 17, FTSW (foot switch), HHCL (hi-hat close), or HHSP (hi-hat splash)
-----------------	--

② **Pad function (Func)**

Use this parameter to set the operation to be performed when the pad or external controller indicated by ① is struck or operated.

- off Voices will be played in the normal way.
- inc kitNo The kit number will be increased by 1.
- dec kitNo The kit number will be decreased by 1.
- inc ptnNo The pattern number will be increased by 1.
- dec ptnNo The pattern number will be decreased by 1.
- inc tempo The tempo will be increased by 1 bpm.
- dec tempo The tempo will be decreased by 1 bpm.
- tap tempo The pad or external controller can be used to tap the tempo.
- clickOn/Off The click track will be turned on or off.
- CC01 to CC95 A MIDI Control Change message will be sent to the internal tone generator and connected external MIDI devices.

Settings	off, inc kitNo, dec kitNo, inc ptnNo, dec ptnNo, inc tempo, dec tempo, tap tempo, clickOn/Off, or CC01 to CC95
-----------------	--

When a MIDI Control Change message (CC01 to CC95) is specified as the pad function, control-change values and the MIDI send channel are set as follows.

If setting a pad or external controller other than “FTSW”:

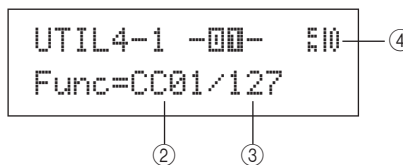

If setting “FTSW” and “ftSw” is selected on the Foot Switch Input page (UTIL4-2):

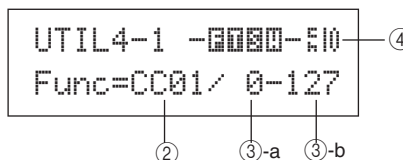

If setting “FTSW” and “ftSw” is not selected on the Foot Switch Input page (UTIL4-2):

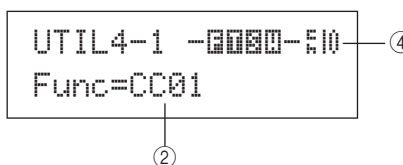

③ **Control change value**

Use this parameter to set a value for the MIDI control-change message indicated by ②.

- **If setting a pad or external controller other than “FTSW”:** This value will be sent when the pad or external controller is struck or operated.
- **If setting “FTSW” and “ftSw” is selected on the Foot Switch Input page (UTIL4-2):** ③-a is the value that will be sent when the foot switch is released, and ③-b is the value that will be sent when the foot switch is depressed.
- **If setting “FTSW” and “ftSw” is not selected on the Foot Switch Input page (UTIL4-2):** A specific control-change value cannot be specified in this case. Instead, a value within the range 0 to 127 will be sent based on the degree by which the hi-hat controller or foot controller is operated.

Settings	0 to 127
-----------------	----------

④ **Control-change send channel**

Use this parameter to set a MIDI channel for sending the MIDI Control Change message indicated by ②.

Settings	1 to 16
-----------------	---------

UTIL4-2 Foot Switch Input page

```
UTIL4-2 <PAD>
FootSwInSel=ftSw ①
```

① Foot switch input selection (FootSwInSel)

Use this parameter to specify whether a foot switch (“ftSw”), a hi-hat controller (“HH65”), or a foot controller (“FC7”) is connected via the FOOT SW jack.

Settings	ftSw, HH65, or FC7
-----------------	--------------------

NOTE

- The velocities sent when a hi-hat controller or a foot controller is connected will depend on the setting made on the Trigger Velocity page (MIDI1-7).
- The velocities sent when a foot switch is connected also depend on the setting made on the Trigger Velocity page (MIDI1-7); however, if “variable” is selected on that page, velocities will be sent with a fixed value of 100.

UTIL4-3 Pad 10-12 Switch page

```
UTIL4-3 <PAD>
Pad10-12=enable ①
```

① Pad10-12

Use this parameter to turn rim pads 10 to 12 on (“enable”) or off (“disable”). This function can prove useful in preventing voices assigned to these rim pads from being played when they are accidentally struck instead of pads 7 to 9.

- enable The rim pads will operate in the normal way.
- disable Functions assigned to these rim pads will be disabled. When they are struck, the DTX-MULTI 12 behaves in the same way as if the corresponding main pads (7 to 9) had been struck.

Settings	enable or disable
-----------------	-------------------

UTIL5 HI-HAT Hi-hat Setup

```
UTIL5
HI-HAT
```

In the HI-HAT section, you can set parameters related to hi-hats. With the HI-HAT page (UTIL5) displayed, press the [ENTER] button to access its three parameter-setting pages (UTIL5-1 to UTIL5-3). You can use the [<]/[>] buttons to navigate between these pages.

UTIL5-1 Close Position page

```
UTIL5-1 <HI-HAT>
ClosePosi=+10 ①
```

① Close position (ClosePosi)

Use this parameter to adjust the position at which the hi-hat switches from open to closed when a hi-hat controller is depressed. The lower the value, the smaller the virtual opening between the top and bottom hi-hats.

Settings	-32 to +0 to +32
-----------------	------------------

UTIL5-2 Splash Sensitivity page

```
UTIL5-2 <HI-HAT>
SplashSens=127 ①
```

① Splash sensitivity (SplashSens)

Use this parameter to set the degree of sensitivity for detecting hi-hat foot splashes. The higher the value, the easier it will be to produce foot-splash sounds with the hi-hat controller. High values may, however, result in splash sounds being unintentionally produced when, for example, you depress the hi-hat controller lightly to keep time. It is a good idea to set this parameter to “off” if you do not want to play foot splashes.

Settings	off or 1 to 127
-----------------	-----------------

UTIL5-3 Send Hi-hat Controller page

```
UTIL5-3 <HI-HAT>
SendHH=on ①
```

① Send hi-hat controller (SendHH)

Use this parameter to enable (“on”) or disable (“off”) the sending of MIDI messages corresponding to continuous motion of the hi-hat controller between the open and closed positions.

Settings	off or on
-----------------	-----------

NOTE

- If “hi-hat” is selected on the Hi-Hat Function page (KIT7-3), MIDI messages will be sent only when this parameter is set to “on”.
- If “MIDI” is selected on the Hi-Hat Function page (KIT7-3), MIDI messages will always be sent, regardless of whether this parameter is set to “on” or “off”.

UTIL6 MIDI

Instrument MIDI Setup

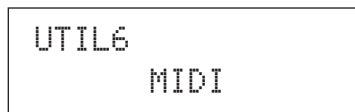

In the MIDI section, you can set MIDI parameters affecting the entire DTX-MULTI 12 system. With the MIDI page (UTIL6) displayed, press the [ENTER] button to access its twelve parameter-setting pages (UTIL6-1 to UTIL6-12). You can use the [

UTIL6-1 Channel-10 Receive page

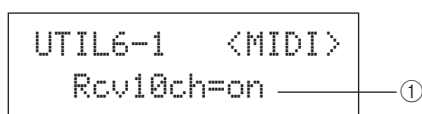

① **Channel-10 receive (Rcv10ch)**

Use this parameter to enable (“on”) or disable (“off”) the receipt of MIDI messages sent by external devices on Channel 10. If set to “off”, the internal tone generator will play voices on Channel 10 in response only to input from the DTX-MULTI 12’s pads and from pads connected via the PAD jacks.

Settings	off or on
----------	-----------

UTIL6-2 Program Change Receive page

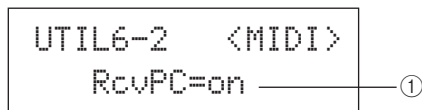

① **Program change receive (RcvPC)**

Use this parameter to enable (“on”) or disable (“off”) the receipt of MIDI Program Change messages. If set to “off” and a new drum kit is selected, voices will be changed only based on settings made for that kit’s preset voices. If you want voices on all MIDI channels to change in line with pattern settings or in response to signals from external MIDI devices, this parameter should be set to “on”.

Settings	off or on
----------	-----------

UTIL6-3 Channel-10 Program Change Receive page

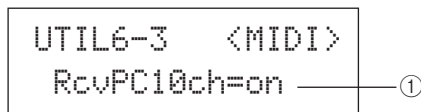

① **Channel-10 program change receive (RcvPC10ch)**

Use this parameter to enable (“on”) or disable (“off”) the receipt of MIDI Program Change messages sent on MIDI channel 10. Select “on” if you want kits to change in line with pattern settings or in response to signals from external MIDI devices. Note that this setting is effective only when “on” is also selected on the Program Change Receive page (UTIL6-2).

Settings	off or on
----------	-----------

UTIL6-4 Polyphonic Aftertouch Status page

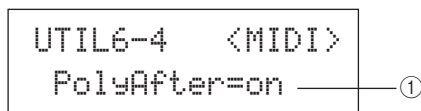

① **Polyphonic aftertouch status (PolyAfter)**

Use this parameter to enable (“on”) or disable (“off”) the exchange of polyphonic aftertouch messages with external MIDI devices.

Settings	off or on
----------	-----------

UTIL6-5 Local Control page

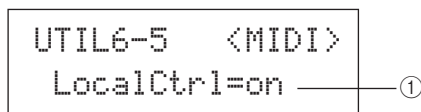

① **Local control (LocalCtrl)**

Use this parameter to enable (“on”) or disable (“off”) playing of the internal tone generator using DTX-MULTI 12 pads and patterns. Normally, this is set to “on”, meaning that the tone generator is locally controlled. If set to “off,” the pads and external controllers are essentially disconnected from the internal tone generator – in other words, no sound is produced by the DTX-MULTI 12 when you strike them.

NOTE

- Even if local control is disabled (i.e., set to “off”) on this page, the DTX-MULTI 12’s internal tone generator can produce sound in response to MIDI messages received via the MIDI IN connector and the USB TO HOST port; furthermore, MIDI messages produced by pads, patterns, and external controllers will be output via the MIDI OUT connector.

Settings	off or on
----------	-----------

UTIL6-6 MIDI Sync page

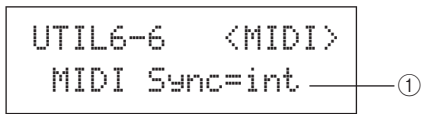

① **MIDI synchronization (MIDISync)**

Use this parameter to specify whether patterns and the click track are to play at the tempo set for the DTX-MULTI 12 or are to be synchronized with external MIDI devices based on MIDI Clock messages (i.e., F8 Timing Clock) received from them.

- int Patterns and the click track will play at the current DTX-MULTI 12 tempo setting. Use “int” when this instrument is to be used alone or as the master clock source for other equipment.
- ext..... The DTX-MULTI 12 will be synchronized with MIDI Clock messages received via MIDI. Use “ext” when an external MIDI device is to be used as the master clock source for synchronized playback.
- auto..... MIDI Clock messages received via MIDI will be prioritized over the DTX-MULTI 12’s current tempo. In other words, playback will be synchronized to MIDI Clock messages whenever they are received, and the internal tempo will be used in all other cases.

Settings	int, ext, or auto
-----------------	-------------------

NOTE

- In order to successfully synchronize the DTX-MULTI 12 whenever this parameter is set to “ext” or “auto”, the connected external MIDI device or computer must be setup to send MIDI Clock messages.

UTIL6-7 Clock Out page

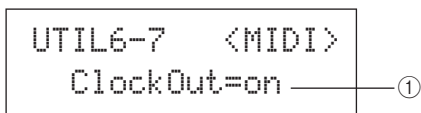

① **Clock out**

Use this parameter to enable (“on”) or disable (“off”) the sending of MIDI Clock messages (i.e., F8 Timing Clock) via the MIDI OUT connector.

Settings	off or on
-----------------	-----------

UTIL6-8 Sequencer Control page

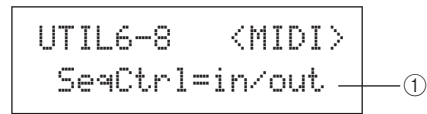

① **Sequencer control (SeqCtrl)**

Use this parameter to specify whether or not System Realtime messages (i.e., FA Start, FB Continue, and FC Stop) will be sent and received via MIDI.

- off.....System Realtime messages are neither sent nor received.
- inSystem Realtime messages are received but not sent.
- outSystem Realtime messages are sent but not received.
- in/out....System Realtime messages are sent and received.

Settings	off, in, out, or in/out
-----------------	-------------------------

NOTE

- If “strtl”, “cont”, or “stop” has been set on the MIDI Message page (MIDI1), the SeqCtrl setting ① will have no effect and the respective message (i.e., FA Start, FB Continue, or FC Stop) will be output.

UTIL6-9 MIDI In/Out page

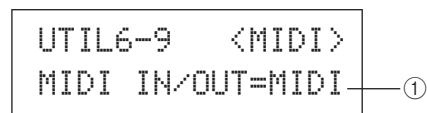

① **MIDI IN/OUT**

Use this parameter to specify whether the exchange of MIDI messages with external devices is to be performed via the MIDI connectors or the USB TO HOST port.

Settings	MIDI or USB
-----------------	-------------

UTIL6-10 MIDI Thru Port page

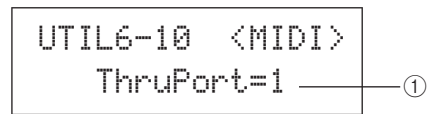

① **MIDI Thru port (ThruPort)**

When the DTX-MULTI 12 receives MIDI messages from a computer connected via USB, it can relay those messages received via a specific port to the MIDI OUT connector so that they can be output to other external MIDI devices. Use this parameter to specify that port.

Settings	1 or 2
-----------------	--------

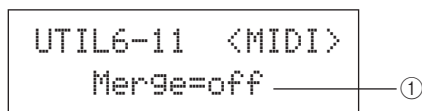
UTIL6-11 MIDI Merge page**① MIDI merge**

The MIDI Merge function allows you to mix MIDI messages received via the MIDI IN connector with performance data produced by playing the DTX-MULTI 12, and to output this mixed MIDI data via the MIDI OUT connector. Set this parameter to “on” to enable this merging of MIDI messages.

Settings	off or on
-----------------	-----------

NOTE

- If “USB” has been selected on the MIDI In/Out page (UTIL6-9), this setting will be displayed as “---” and modification will not be possible.

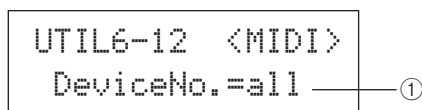
UTIL6-12 Device Number page**① Device number**

Use this parameter to set a MIDI device number for the DTX-MULTI 12. In order to successfully exchange bulk data, parameter changes, and other system exclusive MIDI messages, this setting must match the Device Number of the external MIDI device.

- all System exclusive messages for all MIDI device numbers will be received. In addition, the DTX-MULTI 12 will transmit messages using Device Number 1.
- off System exclusive messages such as bulk dump and parameter changes will be neither transmitted nor received. An error message will be displayed if an attempt is made to perform such an operation.

Settings	1 to 16, all, or off
-----------------	----------------------

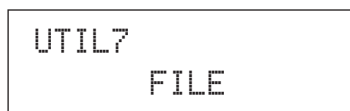
UTIL7 FILE**File Management**

In the FILE section, you can perform a range of file-management operations. With the FILE page (UTIL7) displayed, press the [ENTER] button to access its six parameter-setting pages (UTIL7-1 to UTIL7-6). You can use the [<]/[>] buttons to navigate between these pages.

File-related terms

A number of terms will be used in the following descriptions of file management functions and operations. Please take a moment to familiarize yourself with their meanings in order that these functions and operations can be more easily understood.

File

The term “file” is used to define a collection of data stored on a USB memory device or within the DTX-MULTI 12’s internal memory. The exchange of data with USB memory devices is carried out in the form of files.

File name

As with your computer, the DTX-MULTI 12 can assign names to individual files. These names are used to tell files apart, and for this reason, no two files within a specific directory can share the same file name. Although computers can handle very long file names that can even contain non-English characters, the DTX-MULTI 12 requires that names be limited to eight alphanumeric characters.

File extension

The three letters following the period at the end of a file name – such as “.mid” and “.wav” – are referred to as a “file extension.” The type of data contained within the file is identified by the file extension. Please note that, although this instrument assigns file extensions to file names, they are not displayed on-screen in order to allow the available space to be used more efficiently.

File size

The amount of memory needed to store a file is indicated by the file size. These sizes and also the capacities of memory devices are presented in standard computer format using B (bytes), KB (kilo bytes), MB (mega bytes), and GB (giga bytes). (1 KB is equivalent to 1,024 bytes, 1 MB is equivalent to 1,024 KB, and 1 GB is equivalent to 1,024 MB.)

USB memory device

The term “USB memory device” is used to refer to hard disks and other external USB memory units used for the storage and retrieval of files.

Directory

A hierarchical directory system is used on memory devices in order to group files together according to type or application. In this regard, a “directory” is equivalent to a folder as used on a computer. As with files, you can assign names to individual directories. File operations are carried out inside a set of special directories that are created as follows within a USB memory device when it is formatted for use on the Format page (UTIL7-5). Please note that the DTX-MULTI 12 does not display this directory structure on-screen.

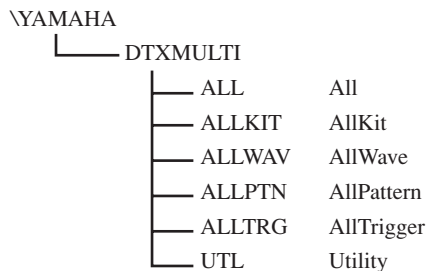

Format

The operation of initializing a USB memory device is referred to as “formatting”. Whenever you format a USB memory device using this instrument, any previously created files and directories (or folders) will be erased and the special directories shown above will be created.

Save and Load

The term “save” refers to the writing of data created on the DTX-MULTI 12 to a USB memory device for storage, while “load” refers to the reading of files from the memory device into the instrument’s internal memory. From the Save File page, you can save files on a USB memory device as follows.

UTIL7-1 Save File page

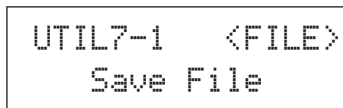

From the Save File page, you can save files on a USB memory device as follows.

1 Plug a USB memory device formatted for use with the DTX-MULTI 12 on the Format page (UTIL7-5) into the USB TO DEVICE port on the side of the instrument.

2 Navigate to the Save File page (UTIL7-1) and press the [ENTER] button.

The Type page (UTIL7-1-1) will open.

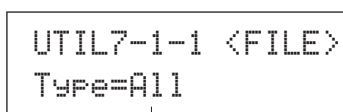

File type

The Type parameter specifies the types of file to be saved.

- AllAll user data – i.e., all User kits, all waves, all User patterns, all User triggers, and utility settings.
- AllKitAll User-kit data
- AllWaveAll wave data
- AllPattern.....All User-pattern data
- AllTriggerAll User-trigger data
- UtilityUtility settings

Settings	All, AllKit, AllWave, AllPattern, AllTrigger, or Utility
-----------------	--

NOTE

- If you select “AllPattern” despite User patterns having not yet being created, a “No Data” error message will be displayed and no data will be saved.
- If you select “AllWave” despite all waves still being empty, a “No Wave Data” error message will be displayed and no data will be saved.

3 Specify a file type using the Type parameter, and press the [ENTER] button.

The Name page (UTIL7-1-2) will open. Set a name for the file to be saved.

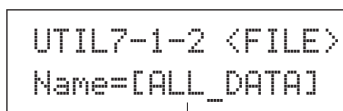

File name

The [<]/[>] buttons can be used to move the flashing cursor, and the [-/DEC] and [+ /INC] buttons can be used to scroll through the available characters. File names can be up to eight characters long.

NOTE

- Any space characters included in file names will be automatically replaced with “_” (i.e., an underscore).

Reference
KIT
VOICE
MIDI
WAVE
PATTERN
UTILITY
TRIGGER

4 When you have set a file name, press the [ENTER] button.

You will be asked to confirm that the data is to be saved. To proceed, press the [ENTER] button. Alternatively, you can press the [EXIT] button to return to Step 3 above without saving.

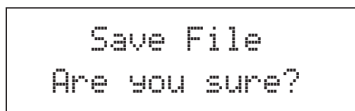

If a file of the same name already exists, you will be asked to confirm whether it is to be overwritten as shown below. If you want to set a different file name to avoid overwriting, press the [EXIT] button to return to the Name page (UTIL7-1-2).

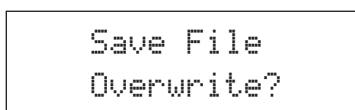

5 Press the [ENTER] button to save the file.

The following message will be displayed as the data is being saved. If you press the [EXIT] button at this time, the save process will be aborted and the display will return to the Name page (UTIL7-1-2).

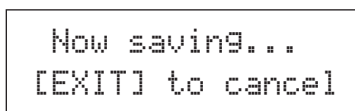

CAUTION

- Do not unplug the USB memory device from the USB TO DEVICE port or turn off either the memory device or the DTX-MULTI 12 while data is being saved. Failure to observe this precaution can lead to the memory device or the DTX-MULTI 12 being permanently damaged.

When the file has been saved, the display will return to the Save File page (UTIL7-1).

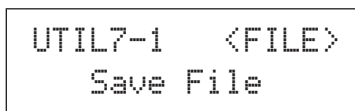

UTIL7-2 Load File page

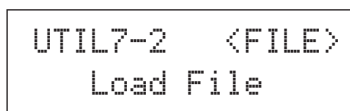

From the Load File page, you can load files previously saved on a USB memory device into the DTX-MULTI 12.

1 Plug the USB memory device containing the required files into the USB TO DEVICE port on the side of the DTX-MULTI 12.

2 Navigate to the Load File page (UTIL7-2) and press the [ENTER] button.

The Type page (UTIL7-2-1) will open.

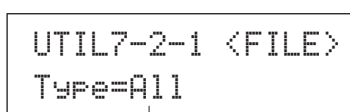

File type

The Type parameter specifies the types of file to be loaded.

- All All user data – i.e., all User kits, all waves, all User patterns, all User triggers, and utility settings.
- AllKit All User-kit data
- Kit A single User kit
- AllWave..... All wave data
- Wave..... A single wave
- AllPattern All User-pattern data
- Pattern A single User pattern
- AllTrigger.... All User-trigger data
- Trigger..... A single User trigger setup
- Utility Utility settings

Settings	All, AllKit, Kit, AllWave, Wave, AllPattern, Pattern, AllTrigger, Trigger, or Utility
-----------------	---

3 Specify a file type using the Type parameter, and press the [ENTER] button.

The File page (UTIL7-2-2) will open.

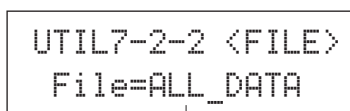

File name

Select the file to be loaded using the [-/DEC] and [+ /INC] buttons. Only those files matching your selection on the Type page (UTIL7-2-1) will be presented for loading. If you are loading a single file, you will first of all need to select the All file that contains it (for example, when loading a single drum kit, you first select a file saved with the type “AllKit”). It is not, however, possible to load a single file when an All type has been selected for loading.

4 When you have selected the file to be loaded, press the [ENTER] button.

If “All”, “AllKit”, “AllWave”, “AllPattern”, “AllTrigger”, or “Utility” was selected:

The applicable page from Step 8 below will be displayed.

If “Kit”, “Wave”, “Pattern”, or “Trigger” was selected:

The applicable page from Step 5 below will be displayed.

5 Select the required package of data from inside the selected file.

You can scroll through the available data using the [-/DEC] and [+ /INC] buttons.

If “Kit” was selected:

```
UTIL7-2-3 <Src>
U001:MyKit
```

If “Wave” was selected:

```
UTIL7-2-3 <Src>
WV001:MyWave
```

If “Pattern” was selected:

```
UTIL7-2-3 <Src>
J U001:MyPtn
```

If “Trigger” was selected:

```
UTIL7-2-3 <Src>
U01:MyTrigger
```

Settings	Kit: U001 to U200 Wave: WV001 to WV500 Pattern: J U001 to J U050 Trigger: U01 to U10
-----------------	---

6 When you have selected the file to be loaded, press the [ENTER] button.

7 Select a destination for the data to be loaded.

The [-/DEC] and [+ /INC] buttons can be used to select the number of the User kit, wave, User pattern, or User trigger to be overwritten with the loaded data.

If “Kit” was selected:

```
UTIL7-2-4 <Dst>
U001:User Kit
```

If “Wave” was selected:

```
UTIL7-2-4 <Dst>
WV001:Empty Wave
```

If “Pattern” was selected:

```
UTIL7-2-4 <Dst>
J U001:Empty Ptn
```

If “Trigger” was selected:

```
UTIL7-2-4 <Dst>
U01:User Trigger
```

Settings	Kit: U001 to U200 Wave: WV001 to WV500 Pattern: J U001 to J U050 Trigger: U01 to U10
-----------------	---

8 When you have selected the file to be loaded, press the [ENTER] button.

You will be asked to confirm that the data is to be loaded.

```
Load File
Are you sure?
```

9 To proceed, press the [ENTER] button.

The following message will be displayed as the data is being loaded.

```
Now loading.....
[EXIT] to cancel
```

CAUTION

- Do not unplug the USB memory device from the USB TO DEVICE port or turn off either the memory device or the DTX-MULTI 12 while data is being loaded. Failure to observe this precaution can lead to the memory device or the DTX-MULTI 12 being permanently damaged.

When the data has been loaded, the display will return to the Load File page (UTIL7-2).

```
UTIL7-2 <FILE>
Load File
```

Reference
KIT
VOICE
MIDI
WAVE
PATTERN
UTILITY
TRIGGER

UTIL7-3 Rename File page

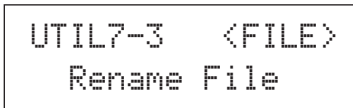

From the Rename File page, you can rename files that have been saved on a USB memory device.

- 1 Plug the USB memory device into the USB TO DEVICE port on the side of the DTX-MULTI 12.
- 2 Navigate to the Rename File page (UTIL7-3) and press the [ENTER] button to open the Type page (UTIL7-3-1).

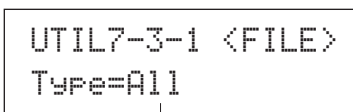

File type

Use the Type parameter to indicate the type of file to be renamed.

- All.....All user data – i.e., all User kits, all User waves, all User patterns, all User triggers, and utility settings.
- AllKit.....All User-kit data
- AllWave.....All wave data
- AllPatternAll User-pattern data
- AllTrigger....All User-trigger data
- UtilityUtility settings

Settings	All, AllKit, AllWave, AllPattern, AllTrigger, or Utility
-----------------	--

- 3 Press the [ENTER] button to open the Rename From page (UTIL7-3-2).

Select the file to be renamed using the [-/DEC] and [+/INC] buttons.

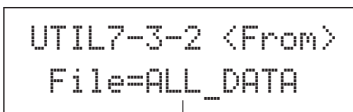

File name

Only those files matching your selection on the Type page (UTIL7-3-1) will be presented for renaming.

- 4 Press the [ENTER] button to open the Rename To page (UTIL7-3-3).

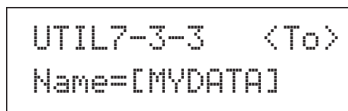

The [<]/[>] buttons can be used to move the flashing cursor, and the [-/DEC] and [+/INC] buttons can be used to scroll through the available characters. File names can be up to eight characters long.

NOTE

- Any space characters included in file names will be automatically replaced with “_” (i.e., an underscore).

- 5 When you have set the new file name, press the [ENTER] button.

You will be asked to confirm that the file is to be renamed.

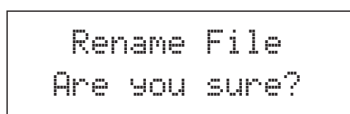

- 6 Press the [ENTER] button to rename the file.

The following message will be displayed as the file is being renamed.

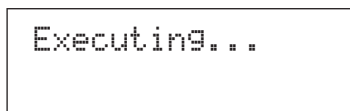

CAUTION

- Do not unplug the USB memory device from the USB TO DEVICE port or turn off either the memory device or the DTX-MULTI 12 while data is being renamed. Failure to observe this precaution can lead to the memory device or the DTX-MULTI 12 being permanently damaged.

When the renaming process has been completed, the message “Completed.” will be displayed. Following this, the display will return to the Rename File page (UTIL7-3).

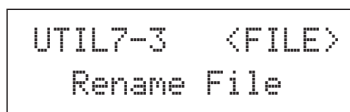

UTIL7-4 Delete File page

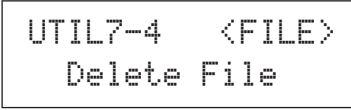

From the Delete File page, you can delete files that have been saved on a USB memory device.

- 1 Plug the USB memory device containing the file(s) you want to delete into the USB TO DEVICE port on the side of the DTX-MULTI 12.
- 2 Navigate to the Delete File page (UTIL7-4) and press the [ENTER] button.

The Type page (UTIL7-4-1) will open.

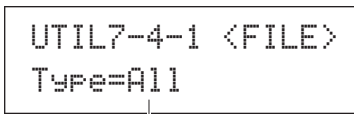

File type

The Type parameter specifies the types of file to be deleted.

- All All user data – i.e., all User kits, all waves, all User patterns, all User triggers, and utility settings.
- AllKit All User-kit data
- AllWave..... All wave data
- AllPattern All User-pattern data
- AllTrigger.... All User-trigger data
- Utility Utility settings

Settings	All, AllKit, AllWave, AllPattern, AllTrigger, or Utility
----------	--

- 3 Specify a file type using the Type parameter, and press the [ENTER] button.

The File page (UTIL7-4-2) will open.

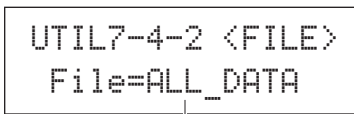

File name

Select the file to be deleted using the [-/DEC] and [+ /INC] buttons. Only those files matching your selection on the Type page (UTIL7-4-1) will be available for selection.

- 4 When you have selected the file to be deleted, press the [ENTER] button.

You will be asked to confirm that the file is to be deleted.

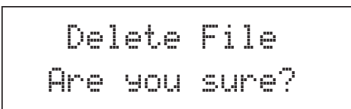

- 5 To proceed, press the [ENTER] button.

The following message will be displayed as the data is being deleted.

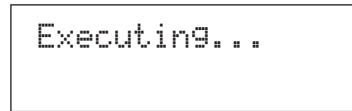

CAUTION

- Do not unplug the USB memory device from the USB TO DEVICE port or turn off either the memory device or the DTX-MULTI 12 while data is being deleted. Failure to observe this precaution can lead to the memory device or the DTX-MULTI 12 being permanently damaged.

When the deletion process has been completed, the message “Completed.” will be displayed. Following this, the display will return to the Delete File page (UTIL7-4).

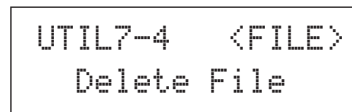

UTIL7-5 Format page

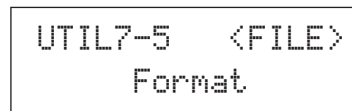

Certain types of USB memory device must be formatted before they can be used with your DTX-MULTI 12. The correct way to format such a device is as follows.

CAUTION

- All data on the USB memory device will be deleted during the formatting process. Before formatting a memory device, therefore, ensure that any important data it contains is backed up.

NOTE

- In certain cases, USB memory devices formatted on a computer will not be recognized by the DTX-MULTI 12. Be sure, therefore, to always use this instrument to format memory devices that will be used with it.

- 1 Plug the USB memory device into the USB TO DEVICE port on the side of the DTX-MULTI 12.
- 2 Navigate to the Format page (UTIL7-5) and press the [ENTER] button.

You will be asked to confirm that the USB memory device is to be formatted.

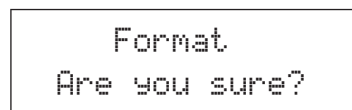

Reference

KIT

VOICE

MIDI

WAVE

PATTERN

UTILITY

TRIGGER

3 To proceed, press the [ENTER] button.

The following message will be displayed as the memory device is being formatted.

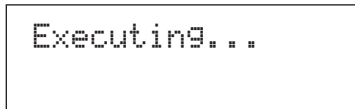

⚠ CAUTION

- When formatting a USB memory device, it must not be unplugged from the USB TO DEVICE port and the memory device and the DTX-MULTI 12 must not be turned off. Failure to observe this precaution can lead to the memory device or the DTX-MULTI 12 being permanently damaged.

When the formatting process has been completed, the message “Completed.” will be displayed. Following this, the display will return to the Format page (UTIL7-5).

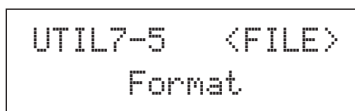

UTIL7-6 Memory Info page

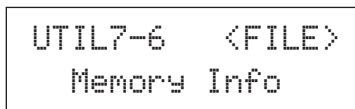

From the Memory Info page, you can check the memory-usage status of a USB memory device. To do so, navigate to the Memory Info page (UTIL7-6) and press the [ENTER] button.

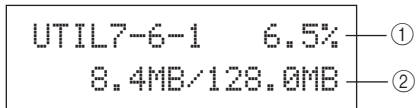

① Memory usage ratio (%)

This indicates how much of the USB memory device’s total memory is currently being used in percentage format.

② Used memory / Total memory

This indicates separately the amount of memory used and the total memory. The units used here will depend on the corresponding memory size (i.e., KB for kilobytes, MB for megabytes, and GB for gigabytes).

UTIL8 FACTORY SET

Instrument Reset

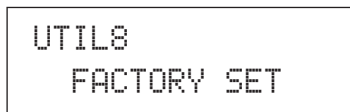

In the FACTORY SET section, you can restore all of the DTX-MULTI 12’s user data (i.e., all User kits, waves, User patterns, User triggers, and utility parameters) to default settings.

⚠ CAUTION

- Whenever the instrument is reset in this way, any settings you have made will be overwritten with the corresponding defaults. All important user-defined data should, therefore, be saved on a USB memory device (see page 93) in advance.

1 Navigate to the Factory Set page (UTIL8) and press the [ENTER] button.

You will be asked to confirm that a Factory Set operation is to be performed.

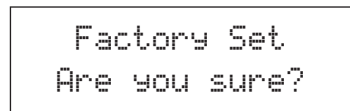

2 To proceed, press the [ENTER] button. Alternatively, you can press the [EXIT] button to cancel the process.

The messages “Executing...” and “Please keep power on.” will be displayed during the Factory Set process.

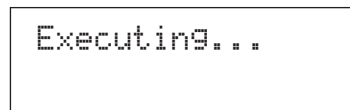

When the process has been completed, the message “Completed.” will be displayed. Following this, the display will return to the Factory Set page (UTIL8).

TRIGGER Setting Area (TRG)

This section describes the TRIGGER setting area, which can be accessed by pressing the [SHIFT] and [UTILITY] buttons simultaneously. The characteristics of the trigger signals output from pads when they are played depend on a range of different factors, such as whether sticks or hands are used, and in the case of external pads, the design of the pads themselves. The TRIGGER setting area allows you to optimize each pad's trigger signals for processing by the DTX-MULTI 12 and to save these settings as trigger setup data.

⚠ CAUTION

- Be sure to store any settings that you have edited before turning off the instrument or selecting a new trigger setup. (See page 45.)

Makeup of TRIGGER Setting Area

The TRIGGER setting area is subdivided into four different sections (TRG1 to TRG4). Use the [<]/[>] buttons to navigate between these sections. If a section contains parameter-setting pages, the [ENTER] button will light up. Press the [ENTER] button to access these pages. In certain cases, a number of additional pages may be accessed from a parameter setting page, also using the lit [ENTER] button. Furthermore, you can press the [EXIT] button to move back towards the top of the setting area.

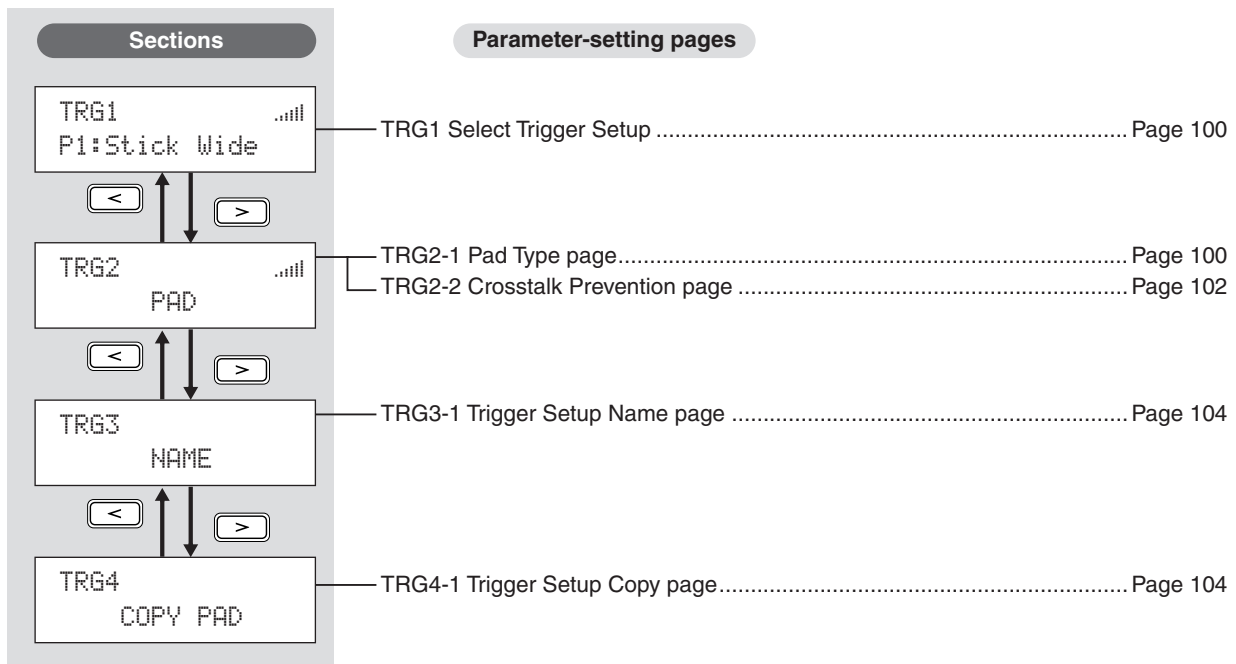

TRG1

Select Trigger Setup

Use these parameters to select the trigger setup that you want to apply or edit.

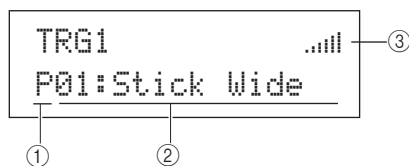

① **Trigger setup category**

Use this parameter to specify either the Preset (P) or User (U) trigger-setup category.

Settings	P or U
-----------------	--------

② **Trigger setup number: Trigger setup name**

Use these parameters to select the trigger setup that you want to apply or edit.

Settings	With "P" (Preset trigger setup) selected: 01 to 05 With "U" (User trigger setup) selected: 01 to 10
-----------------	--

- P01: Stick Wide Stick-playing trigger setup with a wide dynamic range, allowing the softness or hardness of playing to be easily expressed.
- P02: Stick Normal..... Stick-playing trigger setup with a standard, well-balanced response.
- P03: Stick Narrow..... Stick-playing trigger setup with a narrow dynamic range for highly-consistent hit detection. With this setup, the softness or hardness of playing has less effect, allowing differences in volume to be smoothed out.
- P04: Hand Hand-playing trigger setup.
- P05:Finger..... Hand-playing trigger setup that also supports finger-tip playing.
- U01 to U10 User triggers.
Freely-configurable trigger setups for your own unique triggering needs.

③ **Input level indicator**

Visual representation of the input level for the pad(s) being struck.

NOTE

- The Trigger Setup Link page (KIT7-6) can be used to set a complete trigger setup for the current kit. (See page 52)

TRG2 PAD

Pad Setup

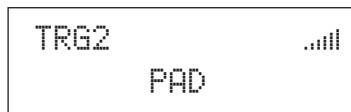

In the PAD section, you can set parameters affecting the sensitivity, output, and other characteristics of each of your DTX-MULTI 12's built-in pads and of external pads connected via the PAD jacks. With the PAD page (TRG2) displayed, press the [ENTER] button to access the Pad Type (TRG2-1) and Crosstalk Prevention (TRG2-2) parameter-setting pages. You can use the [<]/[>] buttons to switch between these pages.

TRG2-1 Pad Type page

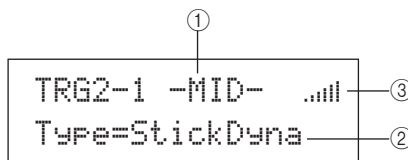

① **Pad**

- Use this parameter to select the pad(s) to be set.
- UPUpper row of built-in rim pads (i.e., 1 to 3)
- MIDMiddle rows of built-in pads (i.e., 4 to 9)
- LOWLower row of built-in rim pads (i.e., 10 to 12)
- 01Built-in pad 1
- : :
- 12Built-in pad 12
- 13External pad connected to PAD ⑬ jack
- : :
- 17External pad connected to PAD ⑰ jack

Layout of built-in pads

01	02	03	UP
04	05	06	
07	08	09	
10	11	12	LOW

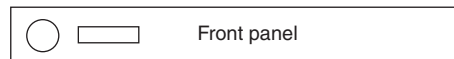

Settings	UP, MID, LOW, or 01 to 17
-----------------	---------------------------

NOTE

- Selection by striking is limited to pad groups (i.e., UP, MID, or LOW) and the external pads (i.e., 13 to 17).

② Pad type

Use this parameter to set a pad type for the pad(s) indicated by ①. Listed below, the available options will depend on whether you selected one or more of the built-in pads (i.e., UP, MID, LOW, or 01 to 12) or one of the external pads (i.e., 13 to 17) using ① above.

Settings	For built-in pads StickDyna, StickNorm, StickNarrow, HandDyna, HandNorm, or Hand
	For external pads KP125W/125, KP65, XP120/100Sn, XP120/ 100Tm, TP120/100Sn, TP120/100Tm, TP65S Snare, TP65S Tom, TP65S HiHat, TP65, PCY155, PCY135, PCY150S, PCY130SC, PCY130S/130, PCY65S/65, RHH135, RHH130, DT Snare, DT HiTom, DT LoTom, DT Kick, TRG Snare 1, TRG Snare 2, TRG Snare 3, TRG HiTom 1, TRG HiTom 2, TRG LoTom 1, TRG LoTom 2, TRG Kick 1, or TRG Kick 2

③ Input level indicator

Visual representation of the input level for the pad(s) being struck.

With a pad and pad type selected on the Pad Type page (TRG2-1), press the [ENTER] button to access the five parameter setting pages (TRG2-1-1 to TRG2-1-5) for that pad type's trigger setup. You can navigate between these pages using the [<]/[>] buttons.

NOTE

- If you have selected the UP, MID, or LOW group of pads, the values initially shown on each parameter-setting page will correspond to those for Pad 4 and 10, respectively. In such a case, furthermore, changes made to any parameter will affect all pads in the group.
- The pad indicator and input level indicator shown on the upper row of text on the five parameter-setting pages (TRG2-1-1 to TRG2-1-5) are identical to those from the Pad Type page (TRG2-1). Accordingly, they are not covered in the following page descriptions.
- If one or more of the built-in pads are set to "HandDyna", "HandNorm", or "HandR", the Hand icon (👊) will be displayed on the Select Kit page (KIT1).

TRG2-1-1 Input Gain page

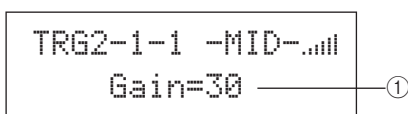

① Gain

Use this parameter to set the level of gain (or amplification) that is applied to the input signal from the selected pad(s) before it is converted into a trigger signal. With a high setting, all input signals above a certain level will be amplified to the same level (i.e., the maximum level). This means that variations in the softness or hardness with which the pad is struck can be smoothed out. Meanwhile, when a low setting is used, the softness or hardness of playing will be reflected to a much greater degree in the output trigger signal, allowing for more expressive performances.

Settings	0 to 63
-----------------	---------

TRG2-1-2 Velocity Curve page

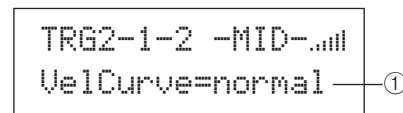

① Velocity curve (VelCurve)

Use this parameter to select a velocity curve for the selected pad(s). A velocity curve determines how the relative strength of playing affects the signal produced. For example, with the "loud2" velocity curve shown below, relatively loud sounds (i.e., high velocities) can be produced even with softer playing. In contrast, the "hard2" curve only produces loud sounds when the pad in question is struck quite hard.

Settings	loud2, loud1, normal, hard1, or hard2
-----------------	---------------------------------------

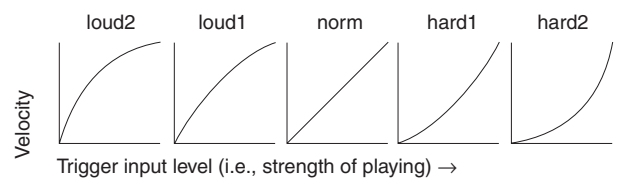

TRG2-1-3 Input Level Range page

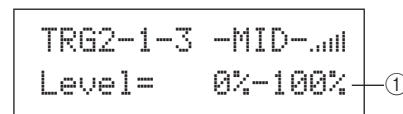

① Level

Use this parameter to set the range of input signals (in percentage format) that will be converted into trigger signals. Any input signals at the minimum level or lower will not be converted into a trigger signal, and therefore, will not produce any sound. Meanwhile, input signals at the maximum level or higher will result in trigger signals with the maximum velocity as set on the Velocity Range page (TRG2-1-4).

Settings	Minimum level: 0% to 99% Maximum level: 1% to 100%
-----------------	---

TRG2-1-4 Velocity Range page

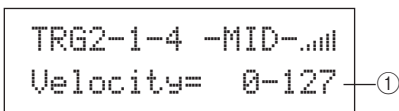

① **Velocity**

Use these parameters to specify the maximum and minimum velocities corresponding to the settings made on the Input Level Range page (TRG2-1-3). When struck, the selected pad(s) will produce sounds within this velocity range.

Settings	Minimum velocity: 0 to 126
	Maximum velocity: 1 to 127

TRG2-1-5 Double Trigger Prevention page

When a stick or beater strikes a pad, it may rebound and strike again, producing a second trigger signal and causing a voice to sound twice. The term “double trigger” is used to refer to this phenomenon. A reject-time setting is used to prevent double triggers from occurring, and the DTX-MULTI 12 will reject any second input signals produced during this time period.

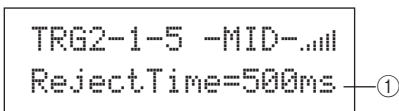

① **Reject time**

Use this parameter to specify the time period after a pad is struck during which a second input signal will be ignored. The larger the value set here, the longer the period during which a second sound will not be produced.

Settings	4ms to 500ms
-----------------	--------------

NOTE

- Double triggers may not be rejected in cases where the pad-type selection on the Pad Type page (TRG2-1) is other than a DT-series pad and the input level of the second strike within the reject time is at least twice that of the first strike.

TRG2-2 Crosstalk Prevention page

The term “crosstalk” refers to the output of trigger signals from a pad other than the one that was struck as a result of vibration or interference between pads. From the Crosstalk Prevention page, you can set input levels below which trigger signals will not be produced, thus preventing crosstalk. With this page displayed, press the [ENTER] button to access the Global Crosstalk Level page (TRG2-2-1) and the Individual Crosstalk Level page (TRG2-2-2). You can switch between these parameter-setting pages using the [<]/[>] buttons.

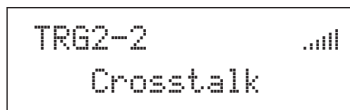

NOTE

- The input level indicator shown on the upper row of text on the crosstalk level pages (TRG2-2-1, TRG2-2-2) is identical to that from the Pad Type page (TRG2-1). Accordingly, it is not covered in the following page descriptions.

TRG2-2-1 Global Crosstalk Level page

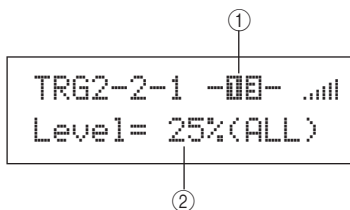

① **Pad**

Use this parameter to select the pad(s) for which a crosstalk level is to be set. You can also strike a pad to select it.

Settings	UP, MID, LOW, or 01 to 17
-----------------	---------------------------

NOTE

- Selection by striking is limited to pad groups (i.e., UP, MID, or LOW) and the external pads (i.e., 13 to 17).

② **Crosstalk level**

Use this parameter to specify a level for preventing crosstalk from all of the DTX-MULTI 12's other pads. If the input level produced at the pad indicated by ① is lower than this level whenever any of the other pads are struck, it will be treated as crosstalk and no trigger signal will be generated. Although higher setting values are more effective in preventing crosstalk, they can also make it difficult to play multiple pads at the same time.

Settings	0% to 99%
-----------------	-----------

TRG2-2-2 Individual Crosstalk Level page

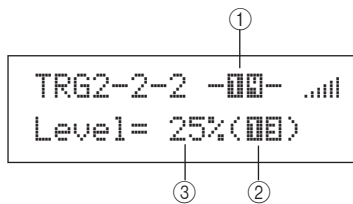

① Pad

Use this parameter to select the pad(s) for which a crosstalk level is to be set. You can also strike a pad to select it.

Settings	UP, MID, LOW, or 01 to 17
----------	---------------------------

NOTE

- Selection by striking is limited to pad groups (i.e., UP, MID, or LOW) and the external pads (i.e., 13 to 17).

② Crosstalk source

Use this parameter to specify a pad or group of pads causing crosstalk in the pad(s) indicated by ①. You can also strike a pad to select it.

Settings	UP, MID, LOW, or 01 to 17
----------	---------------------------

③ Crosstalk level

Use this parameter to specify a level for preventing crosstalk from the pad(s) indicated by ②. If the input level produced at the pad indicated by ① is lower than this level whenever the pad indicated by ② is struck, it will be treated as crosstalk and no trigger signal will be generated. Although higher setting values are more effective in preventing crosstalk, they can also make it difficult to play multiple pads at the same time.

Settings	0% to 99%
----------	-----------

Typical Examples of Crosstalk-Prevention Setup – No. 1

- Use this approach when pad sensitivity is set to allow playing by hand and striking of one of the pads from the MID group (i.e., 4 to 9) causes another pad from that group to produce a sound.

1 Navigate to the Individual Crosstalk Level page (TRG2-2-2) and set its parameters as follows.

①: MID (i.e., pads 4 to 9), ②: MID (i.e., pads 4 to 9)

2 Hold down the [SHIFT] button and press the [UP/DOWN] button to activate the input lock. (-MID- will change to [MID].)

NOTE

- The input lock must be activated here to prevent the selection from changing when one of the other pads from the MID group (i.e., 4 to 9) is struck in the next step.

- #### 3 While striking one of the pads from the MID group (i.e., 4 to 9), raise the level indicated by ③ until other pads from that group no longer produce any sound.

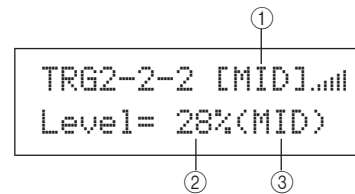

- #### 4 Press the [STORE] button to open the Trigger Store page, and then store your trigger setup as described on page 45.

Typical Examples of Crosstalk-Prevention Setup – No. 2

- Use this approach when pad sensitivity is set to allow playing by hand and, for example, striking of Pad 4 also results in Pad 5 producing a sound

1 Navigate to the Individual Crosstalk Level page (TRG2-2-2) and set its parameters as follows.

①: 05 (i.e., Pad 5), ②: 04 (i.e., Pad 4)

2 Hold down the [SHIFT] button and press the [UP/DOWN] button to activate the input lock. (-05- will change to [05].)

NOTE

- The input lock must be activated here to prevent the selection changing from Pad 5 to Pad 4 when Pad 4 is struck in the next step.

- #### 3 While striking Pad 4, raise the level indicated by ③ until Pad 5 no longer causes a voice to play (i.e., no longer produces a trigger signal).

NOTE

- If this level is set too high, Pad 5 may not produce any sound when struck relatively softly together with Pad 4.

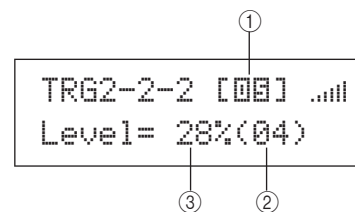

- #### 4 Press the [STORE] button to open the Trigger Store page, and then store your trigger setup as described on page 45.

TRG3 NAME

Trigger Setup Names

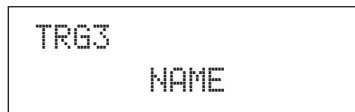

In the NAME section, you can assign a name of up to 12 characters in length to trigger setups. With the NAME page displayed, press the [ENTER] button to open the Trigger Setup Name page (TRG3-1).

TRG3-1 Trigger Setup Name page

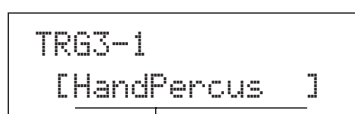

Trigger setup name

On this page, you can assign a name of up to 12 characters in length to the current trigger setup. Use the [<]/[>] buttons to move the flashing cursor to the character you want to change, and then select a character using the [-/DEC] and [+ /INC] buttons. The following characters can be used in pattern names.

[space]

```
!"#$%&'()*+,-./0123456789:;<=>?@
ABCDEFGHIJKLMNOPQRSTUVWXYZ[ \]^_`
abcdefghijklmnopqrstuvwxyz{|}~*
```

TRG4 COPY PAD

Copy Trigger Parameters

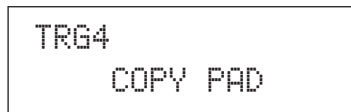

In the COPY PAD section, you can copy and replace data for the currently selected trigger setup on a pad-specific basis. With the COPY PAD page displayed, press the [ENTER] button to open the Trigger Setup Copy page (TRG4-1).

TRG4-1 Trigger Setup Copy page

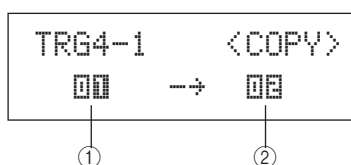

① Pad to copy

Use this parameter to set the pad whose settings are to be copied. You can also strike a pad to select it.

Settings	01 to 17
----------	----------

② Pad to replace

Use this parameter to set the pad whose settings are to be replaced. You can also strike a pad to select it.

Settings	01 to 17
----------	----------

NOTE

- Copying of trigger setup data can only be carried out between the built-in pads (1 to 12) or between the external pads (13 to 17). If you attempt to copy between a built-in pad and an external pad, the above parameters will be automatically changed (to Pad 1 or Pad 13) in order to prevent this from occurring.

When you have selected the pads to copy and replace, press the [ENTER] button. When asked to confirm that you wish to proceed, press the [ENTER] button once again to do so.

⚠ CAUTION

- Whenever trigger-setup data is copied, all of the trigger-setup data for the pad indicated by ② will be replaced.

Be sure, therefore, to use the [STORE] button to access the Trigger Store page and save important information in the instrument's internal memory in advance (see page 45).

Troubleshooting

No sound is produced by striking pads or the volume is lower than expected.

Check your system's connections as follows.

- Ensure that headphones or an external audio system, such as an amplifier and speakers, are correctly connected (See page 10.)
- Ensure that the cables you are using are in good condition.

Check the following and ensure that their respective volume levels are not too low.

- The amplifier and/or speakers connected to the DTX-MULTI 12.
- The VOLUME dial on the front panel. (See page 8.)
- The Volume page for the current kit ([KIT] → KIT2 → KIT2-1). (See page 47.)
- The Voice Volume page for the voices assigned to each of the pads ([VOICE] → VCE2 → VCE2-2). (See page 57.)
- The Master Volume page for the entire instrument ([UTILITY] → UTIL1 → UTIL1-1). (See page 83.)

Check your trigger settings as follows.

- Open the Select Trigger Setup page ([SHIFT] + [UTILITY] → TRG1) and ensure that the trigger setup is suitable for your playing style and any external pads being used. (See page 100.)
- Open the Input Gain and Velocity Curve pages for each of the pads' triggers ([SHIFT] + [UTILITY] → TRG2 → TRG2-1 → TRG2-1-1, TRG2-1-2) and ensure that the Gain and VelCurve parameters are set appropriately. (See page 101.)
- Open the Input Level Range page for each of the pads' triggers ([SHIFT] + [UTILITY] → TRG2 → TRG2-1 → TRG2-1-3) and ensure that the lower setting for the Level parameter is not set too high. At high settings, pads may not produce sounds. (See page 101.)

Check your effect and filter settings.

- It is important to remember that filters, by their very nature, cause all sound to be silenced at certain cutoff-frequency settings.
- Open the Attack Time and Decay Time pages for the voices assigned to each of the pads ([VOICE] → VCE3 → VCE3-1, VCE3-2) and ensure that the Attack and Decay parameters are not set in such a way that voices are being silenced. (See page 58.)

Check your MIDI settings as follows.

- Open the MIDI Message page for each of the pads ([MIDI] → MIDI1) and ensure that "note" is selected. No sound will be produced for any other setting on this page.
- After confirming that the pads are set to play notes on the MIDI Message page (see above), open the Select Voice page ([VOICE] → VCE1) and ensure that a voice other than "no assign" is selected. Pads set to "no assign" will not produce any sound. (See page 56, 62.)
- Open the Velocity Limits page for each of the pads ([MIDI] → MIDI1 → MIDI1-6) and ensure that the lower setting for the Vel-Limit parameter is not too high. At high settings, pads will produce sound only when struck very hard. (See page 64.)
- Open the Trigger Velocity page for each of the pads ([MIDI] → MIDI1 → MIDI1-7) and ensure that the setting for the TrgVel parameter is not too small (resulting in low volumes). (See page 64.)

- Open the Local Control page ([UTILITY] → UTIL6 → UTIL6-5) and ensure that the LocalCtrl parameter is set to "on". (See page 90.)
- Open the MIDI Note page for each of the pads ([MIDI] → MIDI1 → MIDI1-2) and ensure that all layers are not turned off. (See page 63.)

Check your pad settings as follows.

- Open the Pad Function page for each of the pads ([UTILITY] → UTIL4 → UTIL4-1) and ensure that the Func parameter is set to "off". (See page 88.)
- Open the Pad 10-12 Switch page ([UTILITY] → UTIL4 → UTIL4-3) and ensure that the Pad10-12 parameter is set to "enable". (See page 89.)

Check the following if no sound is produced by external tone generators.

- Ensure that MIDI cables have been correctly connected. (See page 12.)
- Open the MIDI In/Out page ([UTILITY] → UTIL6 → UTIL6-9) and ensure that the correct interface has been set for sending MIDI data. If the MIDI IN/OUT parameter is set to "USB", MIDI data will not be sent to external MIDI devices connected via MIDI cables. (See page 91.)
- Ensure that the DTX-MULTI 12 is sending data on the MIDI channel that the external tone generator is set to receive it on. For details regarding settings within the MIDI setting area, see page 61. In addition, see page 76 for more details regarding MIDI settings related to pattern playback.
- Open the External MIDI Switch page ([MIDI] → MIDI2 → MIDI2-2) and ensure that the MIDI Switch parameter is set to "on". When the external MIDI switch is turned off, MIDI messages will not be sent, and therefore, you will not be able to play external MIDI devices using your DTX-MULTI 12. (See page 66.)
- Ensure that a pad function has not been assigned to the pads in question. To do so, open the Pad Function page for each of the pads ([UTILITY] → UTIL4 → UTIL4-1) and ensure that the Func parameter is set to "off". No internal or external sound will be produced by any pad with a function assignment. (See page 88.)
- Open the Pad 10-12 Switch page ([UTILITY] → UTIL4 → UTIL4-3) and ensure that the Pad10-12 parameter is set to "enable". (See page 89.)
- Open the MIDI Message page for each of the pads ([MIDI] → MIDI1) and ensure that "note" is selected. No internal or external sound will be produced for any other setting on this page. (See page 62.)
- Open the Velocity Limits page for each of the pads ([MIDI] → MIDI1 → MIDI1-6) and ensure that the lower setting for the Vel-Limit parameter is not too high. At high settings, pads will produce sound only when struck very hard. (See page 64.)
- Open the Input Level Range page for each of the pads' triggers ([SHIFT] + [UTILITY] → TRG2 → TRG2-1 → TRG2-1-3) and ensure that the lower setting for the Level parameter is not set too high. At high settings, pads may not produce sounds. (See page 101.)

Sounds do not stop, are distorted, or are intermittent and stuttered, etc.

Check the following if unexpected sounds are produced when playing an external tone generator.

- Access the external instrument's MIDI channel settings and ensure that they match the MIDI channel on which the DTX-MULTI 12 is sending data.

Check the following if all of the pads are producing sounds at very high volumes (or high velocities).

- Open the Input Gain page for each pad ([SHIFT] + [UTILITY] → TRG2 → TRG2-1 → TRG2-1-1) and ensure that the Gain parameter is not set too high. (See page 101.)
- Open the Velocity Curve page for each pad ([SHIFT] + [UTILITY] → TRG2 → TRG2-1 → TRG2-1-2) and ensure that the Vel-Curve parameter is set appropriately. (See page 101.)
- Open the Trigger Velocity page for each of the pads ([MIDI] → MIDI1 → MIDI1-7) and ensure that the TrgVel parameter is set appropriately. If, for example, this parameter is set to "127", high velocities will be produced even when the pad is struck lightly. (See page 64.)
- Ensure that you are using only the recommended Yamaha external pads. Products from other manufacturers can output excessively large signals.

Check the following if sounds output from the DTX-MULTI 12 appear to be distorted.

- Ensure that effects have been set appropriately. Sound can be distorted with certain combinations of effect type and parameter settings. (See pages 48, 49, 50, 59, 68, 78.)
- Open the Filter page for the voices assigned to each of the pads ([VOICE] → VCE3 → VCE3-4) and ensure that filters have been setup appropriately. Depending on the type of sound being filtered, certain resonance settings (Q) can produce distortion. (See page 58.)
- Ensure that the MASTER dial is not set to too high a volume, causing clipping to occur.

Check the following if voices play endlessly and do not stop.

- Open the Receive Key-Off page ([MIDI] → MIDI1 → MIDI1-5) and check the setting for the RcvKeyOff parameter. If set to "off", certain types of voice will play endlessly when triggered. (See page 64.) You can silence all voices at any time by holding down the [SHIFT] button and pressing the [MIDI] button.

Check the following if sounds stop unexpectedly during rolls and flams.

- Open the Playing Mode and MIDI Note pages ([MIDI] → MIDI1 → MIDI1-1, MIDI1-2) for the pads in question and check their settings. Delete any unnecessary note assignments for stack or alternate playing.
- Open the Mono/Poly page ([VOICE] → VCE5 → VCE5-1) and ensure that the Mono/Poly parameter is set to "poly". (See page 60.)
- Open the Double Trigger Prevention page for the pad in question ([SHIFT] + [UTILITY] → TRG2 → TRG2-1 → TRG2-1-5) and reduce the setting for the RejectTime parameter. (See page 102.)

Check the following if no sound is produced when the pads are played by hand.

- Open the Select Trigger Setup page ([SHIFT] + [UTILITY] → TRG1) and ensure that "P04:Hand" or "P05:Finger" is selected. (See page 100.)
- Open the Pad Type page for each pad ([SHIFT] + [UTILITY] → TRG2 → TRG2-1) and ensure that the Type parameter is set for playing by hand. (See page 100.)

Check the following if the DTX-MULTI 12 sounds out of tune or seems to be playing the wrong note.

- Open the Master Tune page ([UTILITY] → UTIL1 → UTIL1-2) and ensure that the setting for the M.Tune parameter is not too far removed from "0". (See page 83.)
- If you are concerned about the pitch of a wave, open the Voice Tuning page for that wave ([VOICE] → VCE2 → VCE2-1) and ensure that the setting for the Tune parameter is not too far removed from "+ 0.00". (See page 57.)
- If you are concerned about the pitch of a pattern, open the Transpose page for that pattern ([VOICE] → VCE2 → VCE2-1) and ensure that the setting for the Transpose parameter is not too far removed from "+ 0". (See page 57.)

Check the following if effects produce no changes in the sound.

- Ensure that none of the effect bypass switches have been turned on. (See page 83.)
- Open the Effect Bypass page for the entire instrument ([UTILITY] → UTIL1 → UTIL1-6), and ensure that the applied effects have not been bypassed. (See page 83.)
- Open the Master EQ Bypass page ([UTILITY] → UTIL3 → UTIL3-3) and ensure that the MEQ Bypass parameter is set to "off". (See page 87.)
- Open the Variation Send, Chorus Send, and Reverb Send pages for individual voices ([VOICE] → VCE4 → VCE4-1, VCE4-2, VCE4-3) and ensure that appropriate effect-send levels are set on each. (See page 59.)
- Open the Chorus Send and Reverb Send pages for the currently selected kit ([KIT] → KIT3 → KIT3-1, KIT3-2) and ensure that appropriate effect-send levels are set on each. (See page 48.)

Values cannot be set or buttons do nothing when pressed, etc.

Check the following if pattern playback does not start when the [▶/■] button is pressed.

- Ensure that an empty pattern has not been selected.
- Open the MIDI Sync page ([UTILITY] → UTIL6 → UTIL6-6) and confirm that MIDI Sync is set as required. If this parameter is set to "ext", patterns will only playback when MIDI Clock messages are being received from an external MIDI sequencer or computer; meanwhile, if MIDI Sync is set to "auto", playback will be synchronized to MIDI Clock messages whenever they are received. (See page 91.)

Perform the following if a pattern loops endlessly and does not stop.

- Silence all voices by holding down the [SHIFT] button and pressing the [MIDI] button. This action can be performed at any time.

Note the following regarding wave playback speeds.

- Waves have fixed tempos. They will always play at the tempo of the original imported file regardless of the drum kit tempo and other similar settings.

Carry out the following if the value is displayed as "----" and cannot be changed.

- Open the Pad Function page (UTIL4-1) for the pad in question and ensure that the Func parameter is set to "off". (See page 88.)
- Open the MIDI Note page (MIDI1-2) for the pad in question and ensure that the Note parameter for all layers (A to D) is not set to "off". (See page 63.)

Check the following if pads 10 to 12 cannot be set.

- Open the Pad 10-12 Switch page ([UTILITY] → UTIL4 → UTIL4-3) and ensure that the Pad10-12 parameter is set to "enable". (See page 89.)

Multiple sounds are produced when a single pad is struck.

Perform the following if multiple sounds are produced by the struck pad (i.e., if double triggers are being produced).

- If your external pads and triggers feature output or sensitivity controllers, reduce the output or sensitivity to a more appropriate level.
- Open the Input Gain page for the pad's trigger ([SHIFT] + [UTILITY] → TRG2 → TRG2-1 → TRG2-1-1) and ensure that the Gain parameter is not set too high. (See page 101.)
- Ensure that you are using only the recommended Yamaha drum triggers or trigger sensors. Products from other manufacturers can output excessively large signals, which in turn can result in double triggering.
- Ensure that the heads are not vibrating in an irregular manner, muting them if so required.
- Ensure that drum triggers are attached in the vicinity of the rim and not near the center of the head.
- Ensure that no other objects are coming into contact with the drum trigger.
- Open the Double Trigger Prevention page for the pad(s) in question ([SHIFT] + [UTILITY] → TRG2 → TRG2-1 → TRG2-1-5) and increase the setting for the RejectTime parameter. Avoid setting too large a reject time, as this can make it impossible to accurately detect flams, rolls, and the like. (See page 102.)

Perform the following if sounds are also produced by pads other than the one that was struck (i.e., if crosstalk is occurring).

- Carry out the steps described in the section Typical Example of Crosstalk-Prevention Setup on page 103.
- Open the Global Crosstalk Level and Individual Crosstalk Level pages ([SHIFT] + [UTILITY] → TRG2 → TRG2-2 → TRG2-2-1, TRG2-2-2) and ensure that the Level parameters are set appropriately. (See pages 102, 103.)
- If using a separately-sold pad featuring a level adjuster, ensure that it is set appropriately.
- Open the Input Level Range page for the pad(s) in question ([SHIFT] + [UTILITY] → TRG2 → TRG2-1 → TRG2-1-3) and ensure that the lower setting for the Level parameter is set to an appropriate value. (See page 101.)
- If playing by hand, open the Select Trigger Setup page ([SHIFT] + [UTILITY] → TRG1) and ensure that a suitable trigger setup is selected for the drum kit. (See page 100.)
- If playing with sticks, open the Pad Type page for the pad(s) in question ([SHIFT] + [UTILITY] → TRG2 → TRG2-1) and ensure that the Type parameter is not set for playing by hand. (See page 100.)

Perform the following if only one voice is produced even though two pads are struck simultaneously.

- Open the Input Gain page for the pad not producing a sound ([SHIFT] + [UTILITY] → TRG2 → TRG2-1 → TRG2-1-1) and increase the setting for the Gain parameter. (See page 101.)
- Open the Input Level Range page for the pad not producing a sound ([SHIFT] + [UTILITY] → TRG2 → TRG2-1 → TRG2-1-3) and reduce the lower setting for the Level parameter. (See page 101.)
- Open the Alternate Group page for each of the pads ([VOICE] → VCE5 → VCE5-2) and ensure that they are not assigned to the same alternate group. (See page 60.)
- Open the Trigger Alternate Group page for each of the pads ([MIDI] → MIDI1 → MIDI1-9) and ensure that TrgAltGrp is set to "off" for both. (See page 65.)

Optional add-on products do not operate as expected.

Perform the following checks if consistent, reliable trigger signals cannot be produced using an acoustic drum.

- Ensure that a high-quality drum trigger, such as the DT20, is secured firmly in place using adhesive tape. (Remember to remove any old tape.)

- Carry out the checks listed above in the above section No sound is produced by striking pads or the volume is lower than expected.
- Ensure that the signal cable is securely plugged into the jack on the DT20 or other drum trigger.

Check the following if closed hi-hat sounds cannot be played.

- Open the Pad Type page ([SHIFT] + [UTILITY] → TRG2 → TRG2-1) and ensure that a suitable type has been selected. If you are using a Yamaha RHH130 or RHH135 hi-hat controller, the pad type must be set to either "RHH130" or "RHH135". (See page 100.)

Check the following if edge and cup sounds cannot be played or the choking technique does not work when using a cymbal pad.

- Open the Pad Type page for the connected cymbal pad ([SHIFT] + [UTILITY] → TRG2 → TRG2-1) and ensure that a suitable cymbal-pad type has been selected. (See page 100.)

Perform the following checks if hi-hat splash sounds cannot be played.

- Ensure that the foot controller is connected via the HI-HAT CONTROL jack.
- Open the Splash Sensitivity page ([UTILITY] → UTIL5 → UTIL5-2) and ensure that the SplashSens parameter is set to a suitable level. Note that hi-hat splash sounds will not be produced if "off" has been set here. (See page 89.)

Check the following if a foot switch connected via the FOOT SW jack is not working properly.

- You may have connected the foot switch with the DTX-MULTI 12 already turned on. Ensure that you always connect foot switches before turning on the instrument.

Perform the following if nothing happens when buttons on the front panel are pressed.

- Ensure that the Panel Lock is turned off. (See page 8.)
- Ensure that the Cubase Remote function is turned off. (See page 15.)

Carry out the following checks if data cannot be saved on a USB memory device.

- Ensure that the USB memory device has been correctly formatted. (See page 97.)
- Ensure that the USB memory device has not been write-protected. (See page 12.)
- Ensure that there is sufficient free space on the USB memory device to save the data in question. To confirm how much memory is available for saving data, open the Memory Info page ([UTILITY] → UTIL7 → UTIL7-6). (See page 98.)

Check the following if MIDI data cannot be exchanged with a computer or external MIDI device.

- If you are using USB cables, ensure that they are connected correctly. (See page 13.)
- Open the MIDI In/Out page ([UTILITY] → UTIL6 → UTIL6-9) and check the current setting. If you want to exchange MIDI data with a computer via USB, ensure that the MIDI IN/OUT parameter is set to "USB". Alternatively, if you want to exchange MIDI data with external devices via MIDI cables, ensure that this parameter is set to "MIDI". (See page 91.)

On-screen Messages

Message	Full meaning
Are you sure?	This message is displayed to confirm whether or not you wish to proceed with the selected operation.
Choose user pattern.	This message is displayed if you attempt to perform a pattern management task even though a Pre-set pattern is currently selected. Select a User pattern to proceed with the operation in question.
Completed.	This message is displayed when loading, saving, formatting, and other similar operations have been completed.
Connecting USB device...	This message is displayed when the instrument is busy mounting a USB memory device.
Copy protected.	This message is displayed if operations such as wave editing cannot be performed due to the digital audio source being copy protected.
Executing...	This message is displayed while the instrument is busy performing formatting or another similar management task. Please wait until the operation is completed.
File already exists.	This message is displayed if a file with the same name as the one you are about to save already exists.
File not found.	This message is displayed if no file of the selected type exists.
Illegal file.	This message is displayed if the file selected for loading is unsuitable either for use with the instrument or for the current setting area.
Illegal file name.	This message is displayed if the specified file name is not valid.
Illegal format.	This message is displayed if the standard MIDI file (SMF) you are attempting to import is of Format 1. Please select an SMF of Format 0 to proceed.
Illegal selection.	This message is displayed if an operation cannot be performed in accordance with the settings made.
Illegal wave data.	This message is displayed if the audio file you are attempting to import is of an unsupported format.
Incompatible USB device.	This message is displayed if an unsupported USB device is plugged into the instrument's USB TO DEVICE port.
Invalid USB device.	This message is displayed if the plugged-in USB memory device is not usable in its current condition. As long as the device contains no irreplaceable data, it should be formatted to make it usable.
MIDI buffer full.	This message is displayed if the amount of MIDI data received is too large to process.
MIDI data error.	This message is displayed if an error occurs while receiving MIDI data.
No data.	This message is displayed if you are attempting to perform a pattern management task even though the selected pattern contains no data.
No response from USB device.	This message is displayed if the plugged-in USB memory device fails to respond.
No wave data.	This message is displayed to you are attempting to perform a wave management task even though no wave data exists.
No unused MIDI note.	This message is displayed upon execution of a copy-pad operation if no unused MIDI notes are available.
Now importing... [EXIT] to cancel.	This message is displayed while the instrument is busy importing wave data.
Now loading... [EXIT] to cancel.	This message is displayed while the instrument is busy loading a file.
Now recording...	This message is displayed while the instrument is busy recording a pattern.
Now saving... [EXIT] to cancel.	This message is displayed while the instrument is busy saving a file.
Now working...	This message is displayed while the instrument is tidying up after importing a wave or after you press the [EXIT] button to cancel a load or save operation.
Overwrite?	This message is displayed when saving files to confirm whether or not you wish to overwrite a file of the same name already present on the USB memory device.
Pattern stored.	This message is displayed to confirm that the selected pattern has been successfully stored.
Please keep power on.	This message is displayed while the instrument is busy writing data to its flash ROM. The instrument should never be turned off while in this state. If this precaution is not observed, user data may be lost or the internal system may be damaged, rendering the instrument unable to startup normally when it is next turned on.

Message	Full meaning
Please stop sequencer.	This message is displayed to remind you to stop pattern playback before performing the selected operation.
Read only file.	This message is displayed if you are attempting to perform a file operation using a read-only file.
Sample is protected.	This message is displayed if the selected audio file is write protected and cannot be overwritten.
Sample is too long.	This message is displayed if the audio file is too long to be loaded.
Sample is too short.	This message is displayed if the audio file is too short to be loaded.
Seq data is not empty.	This message is displayed upon activating Record Mode if no empty patterns are available for recording.
Seq memory full.	This message is displayed if the instrument's internal memory for sequence data is full, making it impossible to perform record new patterns, perform associated management tasks, or load data from a USB memory device. To free up some of this sequence memory, delete unneeded User patterns.
System memory crashed.	This message is displayed if a problem occurred while writing data to the instrument's internal flash ROM.
USB connection terminated.	This message is displayed if connection with a USB memory device was lost due to the occurrence of an abnormal electric current. Unplug the USB memory device and press the [ENTER] button to return.
USB device full.	This message is displayed if a USB -memory device is full and no more files can be saved on it. In such a case, use a new USB memory device or make space by erasing unwanted data from the current device.
USB device not ready.	This message is displayed if a USB memory device has not been correctly plugged into the instrument.
USB device read/write error.	This message is displayed if an error occurred during the exchange of data with a USB memory device.
USB device write protected.	This message is displayed if the USB memory device is write protected or if you are attempting to save data on a read-only device such as a CD drive.
Excessive demand for USB power.	This message is displayed if the current being drawn by the USB memory device exceeds the level supported by the instrument.
USB transmission error.	This message is displayed if an error occurred during communication with the USB memory device.
Wave memory full.	This message is displayed if the instrument's wave memory is full, preventing operations such as the importing and loading of data.
Wave stored.	This message is displayed to confirm that the selected wave has been successfully stored.
Utility stored.	This message is displayed to confirm that utility settings have been successfully stored.

Specifications

Pad section	Built-in pads	12
	External inputs	5 (three-zone x 1; monaural x 4)
Tone generator	Maximum polyphony	64 notes
	Wave memory	100 MB (16-bit linear conversion)
	Voices	Drum and percussion: 1,061 Keyboard: 216
	Drum kits	Preset: 50 User-defined: 200
	Effects	Variation x 42 types; Chorus x 6 types; Reverb x 6 types: 5-band master equalizer
Trigger section	Pad functions	Increment or decrement of drum kit, pattern, or tempo; tap tempo; switching on or off of click-track; transmission of control change messages
Waves	Readable quantity	500
	Bit depth	16 bit
	Wave memory	64 MB
	Maximum size	Mono sample: 2 MB Stereo sample: 4 MB
	Sample formats	Proprietary, WAV, and AIFF
Sequencer	Sequence capacity	152,000 notes
	Note resolution	Quarter note / 480
	Recording method	Real-time overdubbing
	Patterns	Preset patterns: 128 phrases (including 3 demo patterns) User-defined patterns: 50 phrases
	Sequence formats	Proprietary SMF Format 0 (for loading only)
Click-track	Tempo	30 to 300 BPM. Tap tempo functionality
	Beats	1/4 – 16/4, 1/8 – 16/8, 1/16 – 16/16
	Note timing	Accent notes, quarter notes, eighth notes, sixteenth notes, triplets
Other	Display	Backlit LCD with 2 rows of 16 characters
	Connectors	PAD ⑬ jack (standard stereo-phone plug; left = trigger, right = rim switch) PAD ⑭/⑮ and PAD ⑯/⑰ jacks (standard stereo-phone plug; left = trigger, right = trigger) HI-HAT CONTROL jack (standard stereo-phone plug) FOOT SW jack (standard stereo-phone plug) OUTPUT L/MONO and R jacks (standard phone plugs) PHONES jack (standard stereo-phone plug), AUX IN jack (standard stereo-phone plug), MIDI IN and OUT connectors, USB TO HOST port, USB TO DEVICE port, and DC IN.
	Power Consumption	9W (DTXM12 and PA-5D adaptor) 6W (DTXM12 and PA-150 adaptor)
	Size and weight	345 (w) x 319 (d) x 96 (h) mm; 3.3 kg
	Package Contents	Power adaptor (PA-5D/PA-150 or an equivalent recommended by Yamaha), Owner's Manual (this booklet), Data List booklet, DVD-ROM

* Specifications and descriptions in this owner's manual are for information purposes only. Yamaha Corp. reserves the right to change or modify products or specifications at any time without prior notice. As specifications, compatible equipment, and optional extras may not be the same in every region, please check with your Yamaha dealer.

Index

Symbols

⏻ Standby/On switch	9, 10, 11
⏻ Switch	9, 10, 11
[+/INC] button	9
[-/DEC] button	9
[<] [VA] [>] buttons	8, 44
[A] button	8, 86
[ENTER] button	8, 45
[EXIT] button	8, 45
[KIT] button	8, 44, 46
[MIDI] button	8, 44, 61
[PTN] button	8, 44, 74
[SHIFT] button	8, 44
[STORE] button	8, 45
[UTILITY] button	8, 44, 82
[VOICE] button	8, 44, 55
[WAVE] button	8, 44, 69

A

Accent note number (NoteAcc)	85
Alternate group	60
AltGroup	60
Attack time	58
AUX IN jack	9
Auxiliary output selection	84
AuxOutSel	84

B

Bandwidth	87
Bank select LSB	66, 67, 77
Bank select MSB	66, 67, 77
Built-in pads	28
Button	8

C

CCNo (Control change number)	65, 68
Ch (MIDI channel)	66, 67, 68, 76, 77
Channel-10 program change receive	90
Channel-10 receive	90
cho (Chorus)	83
ChoPan	36, 50
ChoReturn	36, 49
Chorus	36, 83
Chorus pan	50
Chorus return	49
Chorus send level	48, 59, 68, 78
Chorus to reverb	50
Chorus type	38, 49
ChorusSend	36, 48
ChoSend (Chorus send level)	59, 68, 78

ChoToRev	36, 50
Clear All Patterns	79
Clear Pattern	79
Click button	8, 86
Click-track beat volumes	84
Click-track master volume	84
Click-track output	84
Click-track voice	84
ClkOutSel	84
Clock out	91
Close position	89
ClosePosi	89
Connector	9
Control change number	65, 68
Control change value	65, 68, 88
Control-change send channel	88
Copy Pad	53
Copy Pattern	80
Cord clip	9, 10
Crosstalk	102
Crosstalk level	102, 103
Crosstalk source	103
Cubase Remote Control	15

D

DC IN terminal	9, 10
Decay time	58
Delete	73, 97
Device number	92
Display	8
Drum	30, 31

E

Edit Buffer	42
Effect	36
Effect parameter	48, 49, 50
Exchange Kits	54
Exchange Pads	53
Exchange Patterns	80
External MIDI switch	66

F

F (Frequency)	87
FACTORY SET	98
Fc (Filter cutoff frequency)	58
File	43, 92
Filter cutoff frequency (Fc)	58
FOOT SW	29
FOOT SW jack	9
Foot switch	9, 29
Foot switch input selection	89
FootSwInsel	89

Format	97
Frequency	87
Frequency band	87
Func (Pad function)	88
Function	29

G

G (Gain)	87
Gain	87, 101
GAIN knob	9
Gate time	64

H

Headphones	9, 10
HH Func	52
HH MIDI ch	52
HHMIDIType	52
HI-HAT CONTROL jack	9
Hi-hat controller	9
Hi-hat function	52
Hi-hat MIDI channel	52
Hi-hat MIDI type	52

I

Import	8, 25, 72
Import SMF	80
Initialize Kit	54
Initialize Pad	54
Input level indicator	100
Instrument Reset	98

J

Jack	9
------	---

K

KIT	46
Kit	32
Kit category	47
Kit name	47
Kit number	47
Kit Volume	47

L

Layer	32
Layer Switch	51
Level	101
Load	42, 94
Local Control	13, 90
LocalCtrl	90
Loop	75

- M**
- M.Tune83
 - Master EQ36
 - Master EQ bypass87
 - Master tune83
 - Master volume8, 83
 - Memory42, 43
 - Memory Info73, 81, 98
 - Memory usage ratio73, 81, 98
 - MEQBypass87
 - Merge92
 - Merge Pattern79
 - Message type62
 - MIDI12, 61
 - MIDI Ch (MIDI channel)63, 65, 66
 - MIDI channel (MIDI Ch)63, 65, 66
 - MIDI IN85
 - MIDI IN/OUT91
 - MIDI IN/OUT connectors9, 12
 - MIDI merge92
 - MIDI OUT85
 - MIDI Switch66
 - MIDI synchronization91
 - MIDI Thru port91
 - MIDISync91
 - Mode62
 - Mono/Poly60
 - Mute switch51
 - MuteSw51
- N**
- Normalize73
 - Note57, 63
 - Note_↓85
 - NoteAcc85
- O**
- Optimize73
 - OUTPUT L/MONO and R jacks9
- P**
- Pad100, 102, 103
 - Pad function88
 - Pad indicator8
 - PAD jacks9, 28, 30
 - Pad names16, 28, 100
 - Pad to be copied53
 - Pad to be replaced53
 - Pad type101
 - Pad(s) to copy104
 - Pad(s) to replace104
 - Pad10-1289
 - Pan57, 77
 - Pan depth84
 - Panel Lock8
- Parameter Setting Areas44
- PATTERN74
- Pattern31
- Pattern category75
- Pattern name75, 76
- Pattern number75
- Pattern playback mode56
- Pattern to be copied80
- PC (Program change)66, 67, 77
- PHONES jack9, 10
- Playback mode70
- Playing mode62
- PlayMode70
- Point71
- PolyAfter90
- Polyphonic aftertouch status90
- Power adaptor6, 9, 10
- Power supply10
- Preset kit17, 32, 47
- Preset pattern20, 31, 56
- Preset voice18, 31, 56
- Program change66, 67, 77
- Program change receive90
- Q**
- Q (Bandwidth)87
 - Q (Resonance)59
 - Quantize78
 - Quarter-note note number (Note_↓) 85
- R**
- Ratio73
 - Rcv10ch90
 - RcvKeyOff64
 - RcvPC90
 - RcvPC10ch90
 - REC21
 - Receive key-off64
 - Recording13, 21, 43
 - Reject time102
 - Release time58
 - Rename96
 - Resonance (Q)59
 - rev (Reverb)83
 - Reverb36, 83
 - Reverb pan50
 - Reverb return50
 - Reverb send level48, 59, 68, 78
 - Reverb type50
 - ReverbSend36, 48
 - RevPan36, 50
 - RevReturn36, 50
 - RevSend (Reverb send level)59, 68, 78
- S**
- Save42, 93
 - Send hi-hat controller89
 - SendHH89
 - SeqCtrl91
 - Sequencer control91
 - Shape87
 - SMF file name80
 - Splash sensitivity89
 - SplashSens89
 - Standby/On switch9, 10, 11
 - Startup pattern83
 - Startup trigger83
 - StartupKit83
 - StartupPtn83
 - StartupTrg83
 - Store45
- T**
- Tap tempo8, 29, 86, 88
 - Tempo47, 75
 - Terminal9
 - TGSwitch66
 - ThruPort91
 - Time signature21, 75
 - Tone generator switch66
 - Total memory73, 81, 98
 - Transmit67, 76
 - Transpose57
 - TrgAltGrp (Trigger alternate group) 65
 - TrgMonoPoly65
 - TrgSetupLink52
 - TrgVel64
 - TRIGGER99
 - Trigger alternate group65
 - Trigger mono/poly65
 - Trigger setup category100
 - Trigger setup link52
 - Trigger setup name100
 - Trigger setup number100
 - Trigger velocity64
 - Trim point71
 - Trimming71
 - Tune57
 - Tuning57
 - Turn off all sound8
- U**
- USB memory device11, 23
 - USB TO DEVICE port9, 11
 - USB TO HOST port9, 12, 13
 - Used memory73, 81, 98
 - User kit17, 22, 32, 42
 - User pattern21, 31, 42
 - User trigger30, 42, 100
 - UTILITY82

V

Val (Control change value)	65, 68
Var (Variation send level) ..	59, 68, 77
var (Variation)	83
Variation	36, 83
Variation category	48
Variation pan	49
Variation return	49
Variation send level	59, 68, 77
Variation to chorus	49
Variation to reverb	49
Variation type	48
VarPan	36, 49
VarReturn	36, 49
VarToCho	36, 49
VarToRev	36, 49
VelCurve	101
Velocity	102
Velocity curve	101
Velocity Limits	64
Velocity lower limit	64
Velocity upper limit	64
VOICE	55
Voice	31
Voice category	56
Voice Layer	32
Voice name	56
Voice number	56
Voice Volume	57
Volume (Click-track)	84
Volume (kit)	47
Volume (MIDI)	77
Volume (Voice)	57
VOLUME dial	8
VOLUME knob (headphones)	9

W

WAVE	69
Wave	25, 31
Wave name	70, 71
Wave number	70

MEMO

For details of products, please contact your nearest Yamaha representative or the authorized distributor listed below.

Pour plus de détails sur les produits, veuillez-vous adresser à Yamaha ou au distributeur le plus proche de vous figurant dans la liste suivante.

Die Einzelheiten zu Produkten sind bei Ihrer unten aufgeführten Niederlassung und bei Yamaha Vertragshändlern in den jeweiligen Bestimmungsländern erhältlich.

Para detalles sobre productos, contacte su tienda Yamaha más cercana o el distribuidor autorizado que se lista debajo.

NORTH AMERICA

CANADA

Yamaha Canada Music Ltd.
135 Milner Avenue, Scarborough, Ontario,
M1S 3R1, Canada
Tel: 416-298-1311

U.S.A.

Yamaha Corporation of America
6600 Orangethorpe Ave., Buena Park, Calif. 90620,
U.S.A.
Tel: 714-522-9011

CENTRAL & SOUTH AMERICA

MEXICO

Yamaha de México S.A. de C.V.
Calz. Javier Rojo Gómez #1149,
Col. Guadalupe del Moral
C.P. 09300, México, D.F., México
Tel: 55-5804-0600

BRAZIL

Yamaha Musical do Brasil Ltda.
Rua Joaquim Floriano, 913 - 4º andar, Itaim Bibi,
CEP 04534-013 São Paulo, SP. BRAZIL
Tel: 011-3704-1377

ARGENTINA

**Yamaha Music Latin America, S.A.
Sucursal de Argentina**
Olga Cossettini 1553, Piso 4 Norte
Madero Este-C1107CEK
Buenos Aires, Argentina
Tel: 011-4119-7000

PANAMA AND OTHER LATIN AMERICAN COUNTRIES/ CARIBBEAN COUNTRIES

Yamaha Music Latin America, S.A.
Torre Banco General, Piso 7, Urbanización Marbella,
Calle 47 y Aquilino de la Guardia,
Ciudad de Panamá, Panamá
Tel: +507-269-5311

EUROPE

THE UNITED KINGDOM/IRELAND

Yamaha Music U.K. Ltd.
Sherbourne Drive, Tilbrook, Milton Keynes,
MK7 8BL, England
Tel: 01908-366700

GERMANY

Yamaha Music Europe GmbH
Siemensstraße 22-34, 25462 Rellingen, Germany
Tel: 04101-3030

SWITZERLAND/LIECHTENSTEIN

**Yamaha Music Europe GmbH
Branch Switzerland in Zürich**
Seefeldstrasse 94, 8008 Zürich, Switzerland
Tel: 01-383 3990

AUSTRIA

Yamaha Music Europe GmbH Branch Austria
Schleiergasse 20, A-1100 Wien, Austria
Tel: 01-60203900

CZECH REPUBLIC/SLOVAKIA/ HUNGARY/SLOVENIA

Yamaha Music Europe GmbH Branch Austria
Schleiergasse 20, A-1100 Wien, Austria
Tel: 01-602039025

POLAND/LITHUANIA/LATVIA/ESTONIA

**Yamaha Music Europe GmbH
Branch Sp.z o.o. Oddział w Polsce**
ul. 17 Stycznia 56, PL-02-146 Warszawa, Poland
Tel: 022-868-07-57

THE NETHERLANDS/ BELGIUM/LUXEMBOURG

Yamaha Music Europe Branch Benelux
Clarissenhof 5-b, 4133 AB Vianen, The Netherlands
Tel: 0347-358 040

FRANCE

Yamaha Musique France
BP 70-77312 Marne-la-Vallée Cedex 2, France
Tel: 01-64-61-4000

ITALY

**Yamaha Musica Italia S.P.A.
Combo Division**
Viale Italia 88, 20020 Lainate (Milano), Italy
Tel: 02-935-771

SPAIN/PORTUGAL

Yamaha Música Ibérica, S.A.
Ctra. de la Coruna km. 17, 200, 28230
Las Rozas (Madrid), Spain
Tel: 91-639-8888

GREECE

Philippos Nakas S.A. The Music House
147 Skiathou Street, 112-55 Athens, Greece
Tel: 01-228 2160

SWEDEN

Yamaha Scandinavia AB
J. A. Wettergrens Gata 1, Box 30053
S-400 43 Göteborg, Sweden
Tel: 031 89 34 00

DENMARK

YS Copenhagen Liaison Office
Generatorvej 6A, DK-2730 Herlev, Denmark
Tel: 44 92 49 00

FINLAND

F-Musiikki Oy
Kluuvikatu 6, P.O. Box 260,
SF-00101 Helsinki, Finland
Tel: 09 618511

NORWAY

Norsk filial av Yamaha Scandinavia AB
Grini Næringspark 1, N-1345 Østerås, Norway
Tel: 67 16 77 70

ICELAND

Skifan HF
Skeifan 17 P.O. Box 8120, IS-128 Reykjavik, Iceland
Tel: 525 5000

RUSSIA

Yamaha Music (Russia)
Room 37, bld. 7, Kievskaya street, Moscow,
121059, Russia
Tel: 495 626 5005

OTHER EUROPEAN COUNTRIES

Yamaha Music Europe GmbH
Siemensstraße 22-34, 25462 Rellingen, Germany
Tel: +49-4101-3030

AFRICA

**Yamaha Corporation,
Asia-Pacific Sales & Marketing Group**
Nakazawa-cho 10-1, Naka-ku, Hamamatsu,
Japan 430-8650
Tel: +81-53-460-2313

MIDDLE EAST

TURKEY/CYPRUS

Yamaha Music Europe GmbH
Siemensstraße 22-34, 25462 Rellingen, Germany
Tel: 04101-3030

OTHER COUNTRIES

Yamaha Music Gulf FZE
LOB 16-513, P.O.Box 17328, Jubel Ali,
Dubai, United Arab Emirates
Tel: +971-4-881-5868

ASIA

THE PEOPLE'S REPUBLIC OF CHINA

Yamaha Music & Electronics (China) Co., Ltd.
2F, Yunhedasha, 1818 Xinzha-lu, Jingan-qu,
Shanghai, China
Tel: 021-6247-2211

HONG KONG

Tom Lee Music Co., Ltd.
11/F, Silvercord Tower 1, 30 Canton Road,
Tsimshatsui, Kowloon, Hong Kong
Tel: 2737-7688

INDIA

Yamaha Music India Pvt. Ltd.
5F Ambience Corporate Tower Ambience Mall Complex
Ambience Island, NH-8, Gurgaon-122001, Haryana, India
Tel: 0124-466-5551

INDONESIA

**PT. Yamaha Musik Indonesia (Distributor)
PT. Nusantara**
Gedung Yamaha Music Center, Jalan Jend. Gatot
Subroto Kav. 4, Jakarta 12930, Indonesia
Tel: 021-520-2577

KOREA

Yamaha Music Korea Ltd.
8F, 9F, Dongsung Bldg. 158-9 Samsung-Dong,
Kangnam-Gu, Seoul, Korea
Tel: 02-3467-3300

MALAYSIA

Yamaha Music (Malaysia) Sdn., Bhd.
Lot 8, Jalan Perbandaran, 47301 Kelana Jaya,
Petaling Jaya, Selangor, Malaysia
Tel: 03-78030900

PHILIPPINES

Yupangco Music Corporation
339 Gil J. Puyat Avenue, P.O. Box 885 MCPO,
Makati, Metro Manila, Philippines
Tel: 819-7551

SINGAPORE

Yamaha Music (Asia) Pte., Ltd.
#03-11 A-Z Building
140 Paya Lebar Road, Singapore 409015
Tel: 6747-4374

TAIWAN

Yamaha KHS Music Co., Ltd.
3F, #6, Sec.2, Nan Jing E. Rd. Taipei.
Taiwan 104, R.O.C.
Tel: 02-2511-8688

THAILAND

Siam Music Yamaha Co., Ltd.
4, 6, 15 and 16th floor, Siam Motors Building,
891/1 Rama 1 Road, Wangmai,
Pathumwan, Bangkok 10330, Thailand
Tel: 02-215-2622

OTHER ASIAN COUNTRIES

**Yamaha Corporation,
Asia-Pacific Sales & Marketing Group**
Nakazawa-cho 10-1, Naka-ku, Hamamatsu,
Japan 430-8650
Tel: +81-53-460-2313

OCEANIA

AUSTRALIA

Yamaha Music Australia Pty. Ltd.
Level 1, 99 Queensbridge Street, Southbank,
Victoria 3006, Australia
Tel: 3-9693-5111

NEW ZEALAND

Music Works LTD
P.O.BOX 6246 Wellesley, Auckland 4680,
New Zealand
Tel: 9-634-0099

COUNTRIES AND TRUST TERRITORIES IN PACIFIC OCEAN

**Yamaha Corporation,
Asia-Pacific Sales & Marketing Group**
Nakazawa-cho 10-1, Naka-ku, Hamamatsu,
Japan 430-8650
Tel: +81-53-460-2313

HEAD OFFICE Yamaha Corporation, Digital Musical Instruments Division
Nakazawa-cho 10-1, Naka-ku, Hamamatsu, Japan 430-8650
Tel: +81-53-460-2432



Yamaha Electronic Drums web site:
<http://www.yamaha.co.jp/english/product/drums/ed>
Yamaha Manual Library
<http://www.yamaha.co.jp/manual/>

U.R.G., Pro Audio & Digital Musical Instrument Division, Yamaha Corporation
© 2009 Yamaha Corporation

WR85360 907PO???.?-01A0
Printed in China